

# 21000 and 24701 Proximity Probe Housing Assemblies

## Datasheet

Bently Nevada Machinery Condition Monitoring

141600 Rev. T

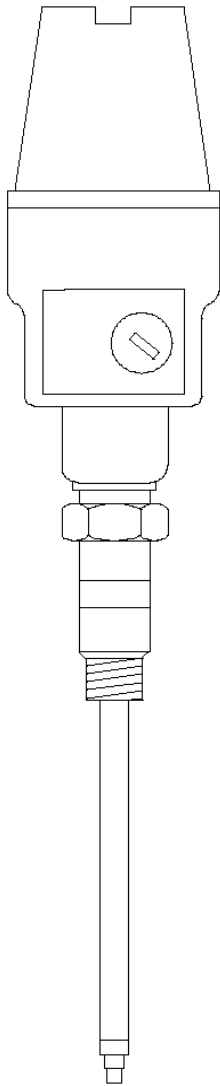

### Description

To externally mount proximity probes, use one of these all-metal Proximity Probe Housing Assemblies:

- 21000 aluminum probe housing assembly
- 24701 stainless steel probe housing assembly

The 21000 and 24701 Proximity Probe Housing Assemblies consist of the following parts:

- A dome cover that screws into the body of the housing
- Threaded ports for conduit connections
- A probe sleeve of optional length
- O-rings
- A reverse mount proximity probe
- A thread seal
- Optional conduit fittings
- An optional standoff adapter



A newer 31000/32000 proximity probe housing assembly is available with more flexible mounting options, better environmental resistance, and other improved features. We recommend this proximity probe housing assembly for installations where an explosion proof housing is not required. See 31000 and 32000 Proximity Probe Housings product datasheet (document 141610).

The 21000 and 24701 Proximity Probe Housing Assemblies are available with Canadian Standards Association (CSA) approvals. They are rated explosion proof for hazardous areas.

You can order hazardous area approved proximity probes with 21000 aluminum and 24701 stainless steel housings for intrinsically safe applications. Both housings are certified as



CSA Type 4 enclosures and are fully compliant with the American Petroleum Institute's (API) 670 Standard for externally mounted proximity probe housings.

The 164818 Compact Proximity Probe Housing is also available for applications with space restrictions. Ceramic capped probes are available with the 164818 housing.

Sleeve length is determined by the location in which the probe and housing are installed. The probe lead must be longer than the sleeve. Sleeve lengths longer than 304 mm (12 inches) require additional sleeve support to reduce the vibration associated with unsupported long sleeve lengths.

Bently Nevada offers a probe support and oil seal (part number 37948-01) for long sleeves that must go through an inner bearing housing. We also make custom sleeve supports.

## Related Documents

For probe information, refer to the following manuals:

- *3300 XL 8mm & 3300 5mm Proximity Transducer System User Guide* (Document 141078)
- *3300 XL NSv Proximity Transducer System User Guide* (Document 147357)
- *3300 XL 11mm Proximity Transducer System Installation User Guide* (Document 146255)
- *Radiation Resistant Probe and Proximator System* (Document TW8029407)

## Specifications

### Environmental

#### Temperature Range

##### 3300 XL 8 mm Probe

Operating and storage	-51 °C to +177 °C (-60 °F to +351 °F)
-----------------------	---------------------------------------

##### 3300 XL 11 mm Probe

Operating and storage	-51 °C to +177 °C (-60 °F to +351 °F)
-----------------------	---------------------------------------

##### 3300 NSV Probe

Operating	-34 °C to +177 °C (-30 °F to +351 °F)
-----------	---------------------------------------

Storage	-51 °C to +177 °C (-60 °F to +351 °F)
---------	---------------------------------------

Monitor Module	1 full-height front slot
I/O Modules	1 full-height rear slot

### CAUTION

**EQUIPMENT DAMAGE** Exposing 3300 XL or 3300 NSV probes to temperatures below -34 °C (-30 °F) may cause premature failure of their pressure seals.

### Mechanical

#### Material

21000	Aluminum body with 304 stainless steel sleeve
-------	---

24701	303 stainless steel body, with 304 stainless steel sleeve
-------	---

#### Mass (Weight)

21000	1.1 kg (2.4 lb) typical, without fittings
-------	---

24701	1.8 kg (4.1 lb) typical, without fittings
-------	---

## Compliance and Certifications

### FCC

This device complies with part 15 of the FCC Rules. Operation is subject to the following two conditions:

- This device may not cause harmful interference.
- This device must accept any interference received, including interference that may cause undesired operation.

### RoHS

RoHS Directive 2011/65/EU

## Hazardous Area Approvals



For the detailed listing of country and product specific approvals, refer to the *Approvals Quick Reference Guide* (108M1756) available from [Bently.com](http://Bently.com).

## 21000 and 24701

CA housings are certified by CSA for explosion - proof applications in the following areas:

North America	Class 1 Divisions 1 and 2 Groups C and D Class 2 Divisions 1 and 2 Groups E, F and G Circuit is non-incendive when connected per drawing 140979 Class III Enclosure Type 4 T5 @ Ta = -50 °C to +40 °C T4 @ Ta = -50 °C to +80 °C
---------------	--

## Ordering Information



For the detailed listing of country and product specific approvals, refer to the *Approvals Quick Reference Guide* (108M1756) available from [Bently.com](http://Bently.com).

### Proximity Probe Housing Assemblies

#### 21000 - AA-BB-CC-DDD-EE-FF

##### A: Probe with Connector

<b>00</b>	Probe not required
<b>14</b>	420 nuclear
<b>15</b>	300 nuclear
<b>16</b>	3300 XL 8 mm probe
<b>26</b>	3300 XL NSv probe
<b>27</b>	3300 XL NSv probe, selectable hazardous area approvals
<b>28</b>	3300 XL 8 mm probe, selectable hazardous area approvals
<b>29</b>	3300 XL 11 mm probe
<b>30</b>	3300 XL 11 mm probe, selectable hazardous area approvals
<b>31</b>	3300 XL NSv probe with connector protector
<b>32</b>	3300 XL NSv probe with connector protector, selectable hazardous area approvals
<b>33</b>	3300 XL 8 mm probe with connector protector
<b>34</b>	3300 XL 8 mm probe with connector protector, selectable hazardous area approvals
<b>35</b>	3300 XL 11 mm probe with connector protector
<b>36</b>	3300 XL 11 mm probe with connector

	protector, selectable hazardous area approvals
<b>37</b>	3300 XL 8 mm probe, ETR, selectable hazardous area approvals (available for 21000 only)

##### B: Probe Cable Length

<b>00</b>	Probe cable not required
<b>05</b>	0.5 m (20 in)
<b>10</b>	1.0 m (39 in)
<b>12</b>	12.0 in
<b>18</b>	18.0 in
<b>24</b>	24.0 in
<b>30</b>	30.0 in
<b>36</b>	36.0 in

##### C: Standoff Adapter Length (Option C Dimension)



Must be ordered if Standoff Adapter Length option is not 00.

<b>15</b>	Minimum length 1.5 in (38 mm)
<b>75</b>	Maximum length 7.5 in (191 mm)
	<b>Recommendation</b> Order in increments of 0.5 in (13 mm)
	<b>Examples</b> 1.5 in (38 mm) = <b>15</b> No standoff adapter = <b>00</b>

##### D: Probe Penetration (Option D Dimension)

<b>10</b>	Minimum length 1.0 in (25.4 mm)
<b>Other</b>	
	<b>Recommendation</b> Order in increments of 0.1 in (3 mm)

**Examples**

3.7 in (94 mm) = **037**

2.4 in (569 mm) = **224**



Probe P/N and S/N may be displayed on a flag label for some combinations of the C plus D options where only a small section of the probe cable is visible.



For probe penetration lengths between 1.0 and 2.0 inches, it may be necessary to counter bore the machine case to reduce probe side view or rear view effects.



If you select a probe penetration length (C plus D) greater than 300 mm (12 in), you must add sleeve support near the probe to prevent resonance from occurring. Adjustment range of probe penetration option D is 13 mm ( $\pm 0.5$  in). For the maximum value of C plus D, [See 21000/CA21000 Dimensions on page 15.](#)

**E: Fittings**

<b>00</b>	Without fittings
<b>01</b>	One explosion-proof fitting and one plug
<b>02</b>	Two explosion-proof fittings
<b>03</b>	One 3/4-14 NPT plug One 3/4-14 to 1/2-14 NPT reducer One cable seal grip with grommets for the following cable sizes: • 1/8 to 3/16 inches • 1/4 to 5/16 inches • 5/16 to 3/8 inches
<b>04</b>	One 3/4-14 NPT plug only



Although explosion-proof fittings are available for all housings, only CA versions of the housing are rated as explosion-proof by CSA when ordered with the **E:00**, **E:01**, **E:02**, or **E:04** options.

**F: Mounting Thread**

<b>01</b>	As cast without threads
-----------	-------------------------

<b>02</b>	3/4-14 NPT
	Will default to 02 option if <b>C:</b> <b>Option Standoff Adapter Length</b> option is not 00.
<b>04</b>	1/2-14 BSP

**24701 -AA-BB-CC-DDD-EE-FF**

**A: Probe with Connector**

<b>00</b>	Probe not required
<b>14</b>	420 nuclear
<b>16</b>	3300 XL series 8mm probe
<b>26</b>	3300 XL NSv probe
<b>27</b>	3300 XL NSv probe, with approval option
<b>28</b>	3300 XL series 8mm, with approval option
<b>29</b>	3300 XL series 11mm
<b>30</b>	3300 XL series 11mm, with approval option
<b>31</b>	3300 XL NSv with connector protector
<b>32</b>	3300 XL NSv with connector protector and approval option
<b>33</b>	3300 XL 8mm with connector protector
<b>34</b>	3300 XL 8mm with connector protector and approval option
<b>35</b>	3300 XL 11mm with connector protector
<b>36</b>	3300 XL 11mm with connector protector and approval option
<b>37</b>	3300 XL 8mm ETR, with approval option

**B: Probe Cable Length**

<b>00</b>	Probe cable not required
<b>05</b>	20 in (0.5 m)
<b>10</b>	39 in (1.0 m)
<b>12</b>	12.0 ft (3.6 m)
<b>18</b>	18.0 ft (3.6 m)
<b>24</b>	24.0 ft (7.3 m)
<b>30</b>	24.0 ft (7.3 m)
<b>36</b>	36.0 ft (10.9 m)

**C: Standoff Adaptor (Option C Dimension)**

<b>15</b>	Minimum length 1.5 in (38 mm)
<b>75</b>	Maximum length 7.5 in (191 mm)
	<b>Examples</b> 1.5 in (38 mm) = <b>15</b> No standoff adaptor = <b>00</b>
	<b>Recommendation</b> Order in increments of 0.5 in (13 mm)

**D: Probe Penetration (Option D Dimension)**

<b>010</b>	Minimum length 1.0 in (25.4 mm)
<b>Other</b>	<a href="#">See 21000/CA21000 Dimensions on page 15.</a>
	<b>Example</b> 3.7 in (94 mm) = <b>037</b> 22.4 in (569 mm) = <b>224</b>
	<b>Recommendation</b> Order in increments of 0.1 in (3 mm)

 Probe P/N and S/N may be displayed on a flag label for some combinations of the C plus D options where only a small section of the probe cable is visible.

For probe penetration lengths between 1.0 and 2.0 inches, it may be necessary to counter bore the machine case to reduce

probe side view or rear view effects.

If you select a probe penetration length (C plus D) greater than 300 mm (12 in), you must add sleeve support near the probe to prevent resonance from occurring. Adjustment range of probe penetration option D is 13 mm ( $\pm$  0.5 in). For the maximum value of C plus D, [See 21000/CA21000 Dimensions on page 15.](#)

**E: Fittings (1)**

<b>00</b>	Without fittings
<b>01</b>	One explosion-proof fitting and one plug
<b>02</b>	Two explosion-proof fittings
<b>03</b>	One 3/4-14 NPT plug One 3/4-14 to 1/2-14 NPT reducer  One cable seal grip with grommets for the following cable sizes: <ul style="list-style-type: none"><li>• 1/8 to 3/16 inches</li><li>• 1/4 to 5/16 inches</li><li>• 5/16 to 3/8 inches</li></ul>
<b>04</b>	One 3/4-14 NPT plug only

**F: Mounting Thread**

<b>01</b>	As cast without threads
<b>02</b>	3/4-14 NPT (see note(2) below).  Must be ordered if Standoff Adapter Length Option is not 00.
<b>03</b>	1-11 1/2 NPT (see note below)
<b>04</b>	1/2-14 BSP
<b>05</b>	7/8-14 UNF-2A

 Although explosion-proof fittings are available for all housings, only CA versions of the housing are rated as explosion-proof by CSA when ordered with the E:00, E:01, E:02, or E:04 options.

## Explosion-Proof Housing Assemblies

 For CA21000 housing, option F must be 02. Options 02 and 03 for mounting threads have more threads than standard NPT threads. They have been machined to have approximately 5 - 7 full threads to increase mounting strength and stiffness.

### CA21000-AA-BB-CC-DDD-EE-F02

 Options **A:00** and **B:00** are linked. If you choose **A:00**, you must also select **B:00**.

#### A: Probe with Connector

00	Probe not required
01	190 series, CSA, BNPS connector
02	190 series, CSA, API connector
27	3300 XL NSv, multiple approval
28	3300 XL series 8mm, multiple approval
30	3300 XL series 11mm, multiple approval
32	3300 XL NSv with connector protector, multiple approval
34	3300 XL 8mm with connector protector, multiple approval
36	3300 XL11mm with connector protector, multiple approval

#### B: Probe Cable Length

05	0.5 metre (20 inches)
20	1.0 metre (39 inches)

#### C: Adaptor (Option C Dimension)

15	Minimum length 1.5 in (38 mm)
75	Maximum length 7.5 in (191 mm)

 Must be ordered if Standoff Adapter Length option is not 00.

	<b>Example</b> 1.5 in (38 mm) = <b>15</b> No Standoff adaptor = <b>00</b>
	<b>Recommendation</b> Order in increments of 0.5 in (13 mm)

#### D: Probe Penetration (Option D Dimension)

010	Minimum length 1.0 in (25.4 mm)
Other	<a href="#">See 21000/CA21000 Proximity Probe Housing Assembly on page 15.</a>
	<b>Example</b> 3.7 in (94 mm) = <b>037</b> 22.4 in (569 mm) = <b>224</b>
	<b>Recommendation</b> Order in increments of 0.1 in (3 mm)

 Probe P/N and S/N may be displayed on a flag label for some combinations of the C plus D options where only a small section of the probe cable is visible.

For probe penetration lengths between 1.0 and 2.0 inches, it may be necessary to counter bore the machine case to reduce probe side view or rear view effects.

If you select a probe penetration length (C plus D) greater than 300 mm (12 in), you must add sleeve support near the probe to prevent resonance from occurring. Adjustment range of probe penetration option D is 13 mm (± 0.5 in).

For the maximum value of C plus D, [See 21000/CA21000 Proximity Probe Housing Assembly on page 15.](#)

#### E: Fittings

00	Without fittings
01	One explosion-proof fitting and one plug



02	Two explosion-proof fittings
03	One 3/4-14 NPT plug One 3/4-14 to 1/2-14 NPT reducer  One cable seal grip with grommets for the following cable sizes: <ul style="list-style-type: none"> <li>• 1/8 to 3/16 inches</li> <li>• 1/4 to 5/16 inches</li> <li>• 5/16 to 3/8 inches</li> </ul>
04	One 3/4-14 NPT plug only

 Although explosion-proof fittings are available for all housings, only CA versions of the housing are rated as explosion-proof by CSA when ordered with the E:00, E:01, E:02, or E:04 options.

For non-explosion-proof housings, if you choose a probe with selectable hazardous area approvals, you must choose a probe with matching approval options.

When ordering a proximator and an extension cable with the housing, choose a probe with matching approval options.

 You can only order probes for CA21000 or CA24701 with multiple approvals. To order CA versions with no probe, select the A:00 option.

### CA24701-AA-BB-CC-DDD-EE-FF

A: Probe with Connector	
00	Probe not required
01	190 series, CSA, BNPS connector
02	190 series, CSA, API connector
27	3300 XL NSv , multiple approval
28	3300 XL series 8mm, multiple approval
30	3300 XL series 11mm, multiple approval
32	3300 XL NSv with connector protector, multiple approval

34	3300 XL 8mm with connector protector, multiple approval
36	3300 XL 11mm with connector protector, multiple approval

### B: Probe Cable Length

00	Probe cable not required
05	20 in (0.5 m)
10	39 in (1.0 m)
12	12.0 ft (3.6 m)
18	18.0 ft (3.6 m)
24	24.0 ft (7.3 m)
30	24.0 ft (7.3 m)
36	36.0 ft (10.9 m)

### C: Adapter (Option C Dimension)

15	Minimum length 1.5 in (38 mm)
75	Maximum length 7.5 in (191 mm)

#### Examples

1.5 in (38 mm) = **15**  
 No standoff adapter = **00**

#### Recommendation

Order in increments of 0.5 in (13 mm)

### D: Probe Penetration (Option D Dimension)

010	Minimum length 1.0 in (25.4 mm)
Other	<a href="#">See 24701/CA24701 Proximity Probe Housing Assembly on page 16.</a>

#### Example

3.7 in (94 mm) = **037**  
 22.4 in (569 mm) = **224**

#### Recommendation

Order in increments of 0.1 in (3 mm)

 Probe P/N and S/N may be displayed on a flag label for some combinations

 of the C plus D options where only a small section of the probe cable is visible.

For probe penetration lengths between 1.0 and 2.0 inches, it may be necessary to counter bore the machine case to reduce probe side view or rear view effects.

If you select a probe penetration length (C plus D) greater than 300 mm (12 in), you must add sleeve support near the probe to prevent resonance from occurring. Adjustment range of probe penetration option D is 13 mm ( $\pm 0.5$  in). For the maximum value of C plus D, [See 24701/CA24701 Proximity Probe Housing Assembly on page 16.](#)

**E: Fittings**

<b>00</b>	Without fittings
<b>01</b>	One explosion-proof fitting and one plug
<b>02</b>	Two explosion-proof fittings
<b>03</b>	One 3/4-14 NPT plug One 3/4-14 to 1/2-14 NPT reducer  One cable seal grip with grommets for the following cable sizes: • 1/8 to 3/16 inches • 1/4 to 5/16 inches • 5/16 to 3/8 inches
<b>04</b>	One 3/4-14 NPT plug only

 Although explosion-proof fittings are available for all housings, only CA versions of the housing are rated as explosion-proof by CSA when ordered with the E:00, E:01, E:02, or E:04 options.

For non-explosion-proof housings, if you choose a probe with selectable hazardous area approvals, you must choose a probe with matching approval options.

When ordering a proximator and an extension cable with the housing, choose a probe with matching approval options.

 You can only order probes for CA21000 or CA24701 with multiple approvals. To order CA versions with no probe, select the A:00 option

**F: Mounting Thread (1)**

<b>01</b>	As cast without threads
<b>02</b>	3/4-14 NPT (see note below).  Must be ordered if Standoff Adapter Length Option is not 00.
<b>03</b>	1-11 1/2 NPT (see note below)
<b>04</b>	1/2-14 BSP
<b>05</b>	7/8-14 UNF-2A

For CA21000 housing, option F must be 02. Options 02 and 03 for mounting threads have more threads than standard NPT threads. They have been machined to have approximately 5 - 7 full threads to increase mounting strength and stiffness.

 (1) For CA21000 housing, option F must be 02. Options 02 and 03 for mounting threads have more threads than standard NPT threads. They have been machined to have approximately 5 - 7 full threads to increase mounting strength and stiffness.

## 164818 Compact Proximity Probe Housing

### 164818-AA-BB-CCC-DD-EE-FF-GG

#### A: Probe with Connector

<b>00</b>	No probe
<b>01</b>	3300 XL NSv probe
<b>02</b>	3300 XL 8 mm probe
<b>03</b>	3300 XL 11 mm probe
<b>04</b>	3300 8 mm ceramic-capped probe
<b>05</b>	3300 XL NSv probe with multiple approvals
<b>06</b>	3300 XL 8 mm probe with multiple approvals
<b>07</b>	3300 XL 11 mm probe with multiple approvals
<b>08</b>	3300 8 mm Ceramic Capped Probe with multiple approvals
<b>12</b>	3300 XL 8 mm probe with connector protector
<b>16</b>	3300 XL 8 mm probe with connector protector, multiple approvals

#### B: Cap Height

<b>20</b>	2.0 inches
<b>40</b>	4.0 inches
<b>60</b>	6.0 inches

#### C: Sleeve Length

<b>010</b>	Minimum length 1.0 in (25.4 mm)
<b>292</b>	Maximum length 29.1 in (167 mm)
	<b>Examples</b> 3.0 in (76.2mm) = <b>030</b> 22.4 in (569 mm) = <b>224</b>
	<b>Recommendation</b> Order in increments of 0.1 in (3 mm)

#### D: Mounting Thread

<b>01</b>	3/4-14 NPT
<b>02</b>	G 3/4 (3/4-14 BSPP)
<b>03</b>	M24 x 1.5

#### E: O-ring Option

<b>01</b>	Viton
<b>02</b>	Neoprene
<b>03</b>	Ethylene propylene

#### F: Read Thread Type

<b>01</b>	1/2-14 NPT
<b>02</b>	M16 x 1.5
<b>03</b>	M20 x 1.5

#### G: Probe Cable Length

<b>05</b>	0.5 metre (20 in)
<b>10</b>	1.0 metre (39 in)

## Accessories

Part Number	Description
37948-01	Probe Support / Oil Seal Recommended for sleeves longer than 305 mm (12 in)

## Individual Probe Sleeve for 21000/24701 Proximity Probe Housings 44382-AAA

#### A: Measured Probe Sleeve Length

	Recommendation Order in increments of 0.1 in (3 mm)
--	--

The individual probe sleeve length does **not** include the distance from the end of the sleeve to the probe tip or the gap from the probe tip to

the target material. If only the part number of the original housing is known, and the sleeve cannot be measured, use the following table to determine the sleeve length:

AAA	Description
Standoff adapter option from original housing (21000, CA21000,24701, or CA24701 option C) <b>plus</b> Probe penetration option from original housing (21000, CA21000, 24701, or CA24701 option D) <b>and</b> 045	All housing AAA options except NSv and 11 mm probes (options other than A:06, A:12, A:26, A:27, A:29, A:30, A:31, A:32, A:35, or A:36)  <b>Example</b> Original part number 21000-16-10-15-035-03-02 <b>AAA</b> option for replacement sleeve (015 + 035 + 045) = <b>095</b>
Standoff Adapter Option from original housing (21000, CA21000,24701, or CA24701 option C) <b>plus</b> Probe penetration option from original housing (21000, CA21000, 24701, or CA24701 option D) <b>and</b> 046	Housing AAA options for 3300 NSv probe options (A:26, A:27, A:31, or A:32)  <b>Example</b> Original part number 24701-31-10-15-090-03-02 <b>AAA</b> option for replacement sleeve (015 + 090 + 046) = <b>151</b>
Standoff Adapter Option from original housing (21000, CA21000,24701, or CA24701 option C) <b>plus</b> Probe penetration option from original housing (21000, CA21000, 24701, or CA24701 option D) <b>and</b> 037	Housing AAA options for 3300 XL 11 mm probe options (A:29, A:30, A:35, or A:36)  <b>Example</b> Original part number CA24701-36-10-40-053-02-02 <b>AAA</b> option for replacement sleeve (040 + 053+ 037) = <b>130</b>
Standoff Adapter Option from original housing (21000, CA21000,24701, or CA24701 option C) <b>plus</b>	Housing AAA options for 7200 Series 11 mm probe options (A:06 or A:12)

AAA	Description
Probe penetration option from original housing (21000, CA21000, 24701, or CA24701 option D) <b>and</b> 039	<b>Example</b> Original part number CA24701-12-10-30-113-01-02 <b>AAA</b> option for replacement sleeve (030 + 113+ 039) = <b>182</b>
<b>Minimum Probe Sleeve Length</b>	
For all probes except NSv and 11 mm probes	5.5 in (140 mm) = 0 55
3300 XL NSv probe	5.5 in (142 mm) = 05 6
3300 XL 11 mm probe	4.7 in (119 mm) = 04 7
<b>Maximum Probe Sleeve Length</b>	
All 0.5 meter probes except NSv and 11 mm probes	18.0 in (457 mm) = 180
3300 XL NSv 0.5 meter probe	18.1 in (460 mm) = 181
7200-series 0.5 meter 11 mm probe	15.4 in (391 mm) = 15 4
All 1.0 meter probes except NSv and 11 mm probes	33.7 in (856 mm) = 3 3 7
3300 XL NSv 1.0 meter probe	33.8 in (859 mm) = 338
3300 XL 1.0 meter 11 mm probe	32.9 in (836 mm) = 32 9
7200 Series 1.0 meter 11 mm probe	33.1 in (841 mm) = 331

### Individual Standoff Adapter 21003-AAA

#### A: Individual Standoff Adapter

<b>015</b>	Minimum length 1.5 in (38 mm)
------------	-------------------------------

<b>075</b>	Maximum length 7.5 in (191 mm)
Recommendation	Order in increments of 0.5 in (13 mm)  4.5 in (114 mm) = <b>045</b>

**Example 1** For desired probe penetration lengths of less than 25 mm (1.0 in), order a separate Individual Standoff Adapter.  
  
The effective probe penetration length will then be reduced by the length of the Individual Standoff Adapter, **plus** an additional 13 mm (0.5 in) due to the NPT thread engagement.

**Example 2** To create a probe penetration length 13 mm (0.5 in), order a 21000 housing with DDD (probe penetration) option of 030 [76 mm (3 in)] and a separate individual standoff adapter that is 51 mm (2.0 in) in length (part number 21003-020).  
  
The standoff adapter covers 38 mm (2.0 in) of the probe sleeve **plus** an additional 13 mm (0.5 in).  
  
Therefore, the effective probe penetration length drops to 13 mm (0.5 in).



If you use effective penetration lengths of less than 1.0 inches, signal effects are likely due to probe side view or rear view of metal components.

**Spare 3300 XL 8 mm Reverse Mount Probe, 3/8-24 UNF threads**  
**330105-02-12-CC-DD-EE**

**A: Total Length**

<b>05</b>	0.5 meter (1.6 feet)
<b>10</b>	1.0 meter (3.3 feet)
<b>15</b>	1.5 meter (4.9 feet)
<b>20</b>	2.0 meters (6.6 feet)
<b>50</b>	5.0 meters (16.4 feet)
<b>90</b>	9.0 meters (29.5 feet)

**B: Connector**

<b>00</b>	Connector not installed
<b>02</b>	Miniature ClickLoc coaxial connector

**Agency Approval**

<b>00</b>	Not required
<b>05</b>	Multiple approvals

**Spare 3300 NSV Reverse Mount Probe, 3/8-24 UNF threads**  
**330906-02-12-CC-DD-EE**

**C: Total Length**

<b>05</b>	0.5 meter (1.6 feet)
<b>10</b>	1.0 meter (3.3 feet)
<b>50</b>	5.0 meters (16.4 feet)
<b>70</b>	7.0 meters (23.0 feet)

**D: Connector**

<b>00</b>	Connector not installed
<b>02</b>	Miniature ClickLoc coaxial connector

**E: Agency Approval**

<b>00</b>	Not required
<b>05</b>	Multiple approvals

## Spare 3300 XL 11 mm Reverse Mount Probe, 3/8-24 UNF threads

### 330705-02-18-CC-DD-EE

---

**C: Total Length**

<b>10</b>	0.5 meter (1.6 feet)
<b>50</b>	5.0 meters (16.4 feet)
<b>90</b>	9.0 meters (29.5 feet)

---

**D: Connector**

<b>00</b>	Without connector
<b>02</b>	With miniature male coaxial connector

---

**E: Agency Approval**

<b>00</b>	Not required
<b>05</b>	Multiple approvals

## Graphs and Figures

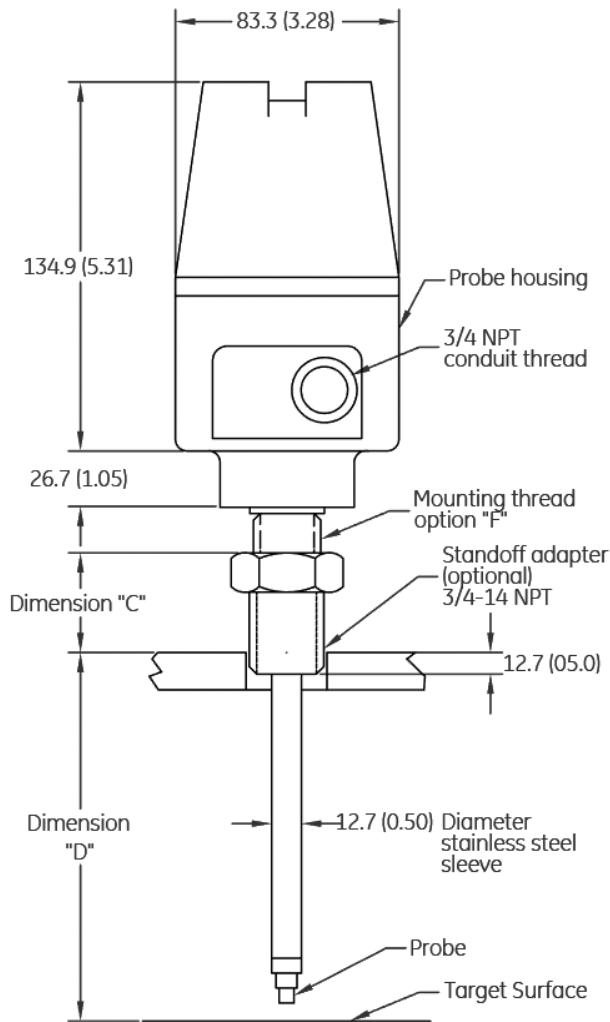

**21000/CA21000 Dimensions**

Probe Cable Length	Maximum (C) + (D) with visible probe (P/N and S/N)	Maximum (C) + (D) Dimension
12 in	Not visible	5.0 in (12.7 cm)
18 in	4.0 in (10.1 cm)	10.5 in (26.6 cm)
24 in	9.7 in (24.6 cm)	16.1 in (40.9 cm)
30 in	15.4 in (39.1 cm)	21.7 in (51.1 cm)
36 in	21.1 in (53.6 cm)	27.3 in (69.3 cm)
0.5 m	Not visible	13.5 in (34.3 cm)
1.0 m	17.0 in (43.18 cm)	32.9 in (83.5 cm)

**Figure 1: 21000/CA21000 Proximity Probe Housing Assembly**

Dimensions are in millimeters (inches).

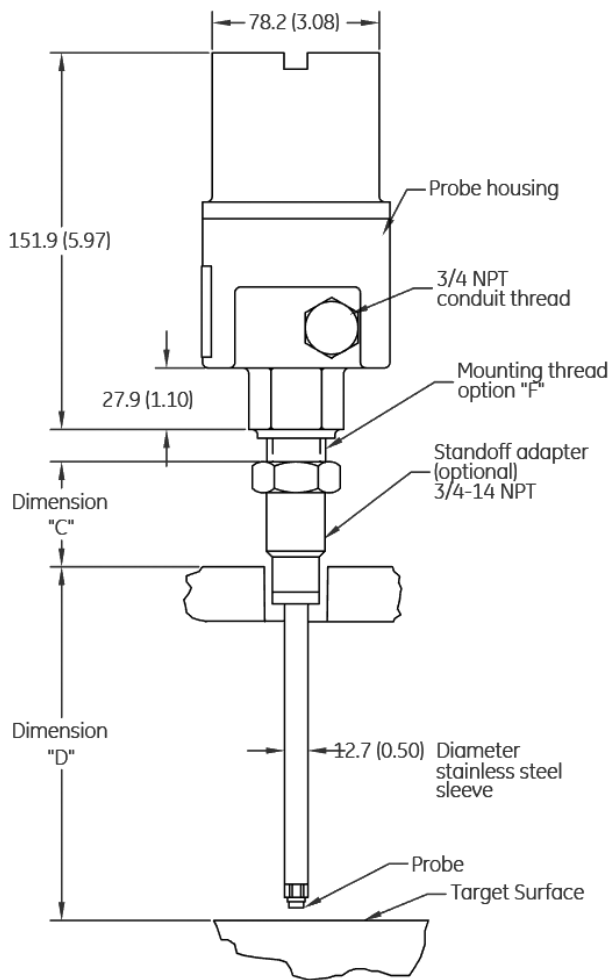

**24701/CA24701 Dimensions**

Probe Cable Length	Maximum (C) + (D) with visible probe (P/N and S/N)	Maximum (C) + (D) Dimension
12 in	Not visible	5.0 in (12.7 mm)
18 in	4.0 in (10.1 cm)	10.5 in (26.6 mm)
24 in	9.7 in (24.6 cm)	16.1 in (40.9 mm)
30 in	15.4 in (39.1 mm)	21.7 in (51.1 mm)
36 in	21.1 in (53.6 mm)	27.3 in (69.3 mm)
0.5 m	Not visible	13.5 in (34.3 mm)
1.0 m	17.0 in (43.18 mm)	29.2 in (74.2 mm)

**Figure 2: 24701/CA24701 Proximity Probe Housing Assembly**

Dimensions are in millimeters (inches).



## Tables

**Table 1: For Figure 1, Dimensions in mm (inches).**

Catalog Number	Dimension			
	A	B	C and D	E
21000	83.3 (3.28)	161.6 (6.36)	See Ordering Option C &D	26.7 (1.05)
24701	78.2 (3.08)	151.9 (5.97)	See Ordering Option C &D	27.9 (1.10)

**Table 2: Maximum Length of C and D Dimension for Proximity Probes**

Probe Cable Length	Maximum C and D Dimension
0.5 metre (3300 Series)	343 mm (13.5 in)
1.0 metre	742 mm (29.2 in)

**Table 3: Maximum C and Dimension with Standard P/N and S/N Label (non-flag label)**

Probe Cable Length	Maximum C and D Dimension
0.5 metre	Not visible
1.0 metre	432 mm (17 m)

Copyright 2021 Baker Hughes Company. All rights reserved.



Bently Nevada, Orbit logo and Proximitor are registered trademarks of Bently Nevada, a Baker Hughes Business, in the United States and other countries. The Baker Hughes logo is a trademark of Baker Hughes Company. All other product and company names are trademarks of their respective holders. Use of the trademarks does not imply any affiliation with or endorsement by the respective holders.

Baker Hughes provides this information on an "as is" basis for general information purposes. Baker Hughes does not make any representation as to the accuracy or completeness of the information and makes no warranties of any kind, specific, implied or oral, to the fullest extent permissible by law, including those of merchantability and fitness for a particular purpose or use. Baker Hughes hereby disclaims any and all liability for any direct, indirect, consequential or special damages, claims for lost profits, or third party claims arising from the use of the information, whether a claim is asserted in contract, tort, or otherwise. Baker Hughes reserves the right to make changes in specifications and features shown herein, or discontinue the product described at any time without notice or obligation. Contact your Baker Hughes representative for the most current information.

The information contained in this document is the property of Baker Hughes and its affiliates; and is subject to change without prior notice. It is being supplied as a service to our customers and may not be altered or its content repackaged without the express written consent of Baker Hughes. This product or associated products may be covered by one or more patents. See [Bentley.com/legal](https://www.bentley.com/legal).

1631 Bently Parkway South, Minden, Nevada USA 89423  
Phone: 1.775.782.3611 (US) or [Bentley.com/support](https://www.bentley.com/support)  
[Bentley.com](https://www.bentley.com)