

# Multilin Intelligent Line Monitoring System

Delivering actionable intelligence for improved reliability and efficiency

Distribution utilities are faced with regulatory requirements to improve reliability, while operating and maintaining aging infrastructure with limited maintenance and capital improvement budgets. GE's Multilin™ Intelligent Line Monitoring System equips distribution utilities with tools and applications to meet these challenges.

GE's innovative Multilin Intelligent Line Monitoring System provides situational awareness along distribution feeders enabling distribution utilities to operate and respond based on prevailing conditions. The system provides utilities with high quality, time coherent data throughout their distribution networks, allowing them to improve performance, reliability and efficiency.

GE's expertise in distribution networks and system development provides the experience needed to address the utilities challenges and deliver proven and sustainable network performance improvement.

## Key Benefits

- End-to-end solution delivers extended visibility into the distribution network
- Reduced cost of ownership with GE's sensors designed for easy installation on live networks
- Designed to meet the challenges of capturing faults in both low and high impedance grounding treatments
- Advanced analytical applications enabled by GE's patented time synchronized data, with measured data also available in DNP3 format
- Remote firmware upgrades enable further application development and compliance with regulatory and operational requirements

## Applications

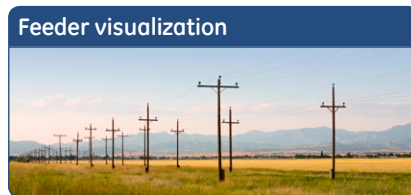

## Enhanced Network Visibility

- Provides increased situational awareness along distribution feeders
- Enables utilities to operate and respond based on prevailing feeder conditions, not static or seasonal estimates

## Reduced Outage Duration

- Enables faster response reducing SAIDI and CAIDI indices
- Identifies fault location alerting operators visually and notifying repair crews via email and SMS messaging
- Promotes targeted spend of maintenance funds based on performance instead of age of asset

## Increased Network Capacity

- Provides the visibility to compute dynamic line ratings based on prevailing conditions
- Enables distribution utilities to better manage their feeders, avoid conductor degradation and knowledgeably deploy sustainable generation

## System Overview

The modular design of GE's monitoring system enables customers to tailor their own monitoring platform so that it aligns with their key strategies for performance improvement of the network, whether this is fault location, increased capacity through dynamic line rating or enhanced network visibility. The system consists of three key components:

- Multilin FMC line sensors that provide accurate data inputs on line load and conductor temperature
- Multilin SNG™ (Sensor Network Gateway) that provides two way communications between the line sensors, and weather stations to server based applications and SCADA
- Server-Based Applications:
  - Feeder visualizer application
  - Fault detection, location and analysis application (Multilin X-NET™)
  - Dynamic line rating calculation and analysis application (Multilin T-NET™)
  - System diagnostics application
  - Measured data also available in DNP3 format

## Data Synchronization

GE's Intelligent Line Monitoring system is time synchronized enabling data from multiple locations along the distribution network to be aligned to within 40µs creating an accurate snapshot of the network suitable for advanced analytics. GE's applications use this technique to align the values captured at the substation and along the feeder to provide a coherent image of the network performance under normal operations as well as under faulted conditions.

## System Components

### Line Sensors

As part of the Intelligent Line Monitoring System, the sensors play a key role in providing visibility along the distribution network. The sensor measures and records the current, both amplitude and phase, at 32 samples per cycle, and supports two way communications with the SNG via an on-board 2.4 GHz radio.

The sensor is configured to detect fault conditions facilitating rapid identification and notification. In addition, the sensors can be configured to provide periodic measurements to facilitate improved situational awareness and operations. The sensor can be supplied with a temperature probe fitted on a flying lead that measures the surface temperature of the conductor facilitating dynamic line rating analysis and conductor temperature monitoring.

### Weather Monitoring Equipment

Weather information is a critical data source for dynamic line rating and ice load warning applications. These applications depend on wind speed and direction, ambient temperature, dew point and solar radiation. The Intelligent Line Monitoring System employs a weather station with an ultrasonic anemometer option to deliver enhanced dynamic line rating analytics. Wind speed and direction averaging techniques enable utilities to set increased circuit ratings based on a greater understanding of prevailing conditions. The optional weather station and ultrasonic anemometer communicate with the SNG via a hardwired link.

## GE's Intelligent Line Monitoring System



Software Applications  
(Measured DNP3 Data  
and Server-Based)

Multilin FMC-T6  
(Line Sensor)

Multilin SNG  
(Sensor Network Gateway)

The components of GE's monitoring system enable utilities to improve network performance through fault location, dynamic line rating and enhanced network visibility

## Sensor Network Gateway

The Multilin Sensor Network Gateway (SNG) provides connectivity between the applications and the field, ensuring visibility along the distribution network. The SNG is a communications gateway for the distribution network and weather information required for advanced applications such as fault detection, location and analysis, dynamic line rating, maintenance planning and feeder visualization.

The SNG provides two way communications to the line sensors by 2.4 GHz radio and to the weather monitoring equipment by a hardwired link. The SNG also performs another important function by recording voltage, both amplitude and phase, at 32 samples per cycle via substation or feeder voltage transformers (VT's). The SNG is equipped with several backhaul options for communicating with the advanced applications including 2G/3G GRPS/UMTS as well as Serial and Ethernet communication ports. Each SNG is equipped with a GPS transceiver that synchronizes the entire system, enabling GE's advanced analytics.

The SNG is versatile and can be installed along the distribution feeder communicating with the line sensors or in a substation for voltage monitoring. Typical feeder installation scenarios include a single SNG with three sensors (one sensor per phase) or a single SNG with six sensors located at a branch port or feeder tap enabling it to effectively monitor two circuits at one site.



## Server Based Applications

In addition to measured data provided in DNP3 format, the Intelligent Line Monitoring System has a suite of server based applications including:

- Multilin X-NET Software Application for fault detection, location and analysis:
  - Fault location
  - Fault signature as RMS values on a cycle by cycle basis
  - Fault notification (SMS and email)
  - Graphical depiction of outage history
  - Data download facility - monitored network data, in user defined time periods (available in Microsoft® Excel format)
- Multilin T-NET Software Applications for dynamic line rating:
  - Dynamic line rating calculation (CIGRE model)
  - Local sag/clearance calculator
  - Site specific ice load warning (Rime)
  - Weather data monitoring
  - Data download facility - monitored network data, in user defined time periods (available in Microsoft Excel format)
- System diagnostics and maintenance application
  - System diagnostics
  - Remote SNG firmware updates
  - Remote line sensor firmware updates
  - Directory for email and SMS recipients
  - Fault threshold settings
  - Monitoring frequency configuration

## Server Based Applications: Weather Data Monitoring

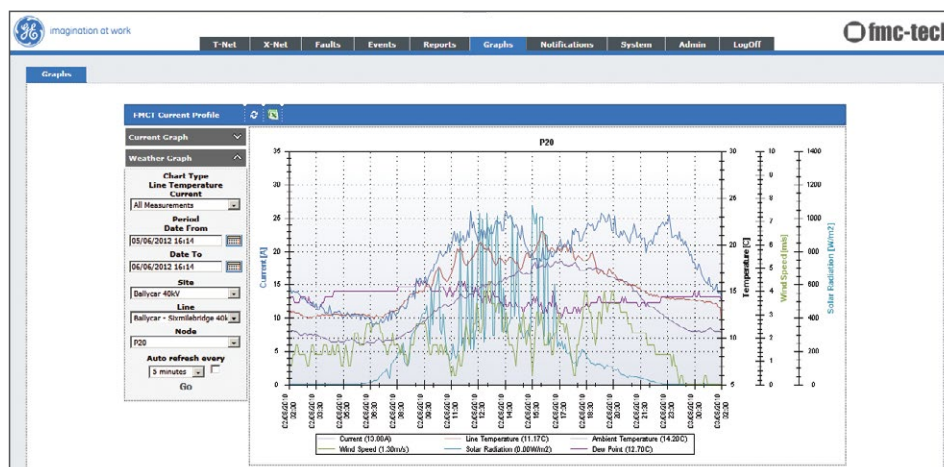

Tracking of weather conditions allow for determining the effect of local weather conditions on capacity of the feeders

# Application Overview: Dynamic Line Rating Analysis

GE's Multilin T-NET advanced analytics compute dynamic line ratings based on prevailing conditions enabling distribution utilities to:

- Better manage their feeders,
- Avoid conductor degradation, and
- Knowledgeably deploy sustainable generation

## Dynamic Line Rating (T-NET)



The dynamic line rating application provides actionable information enabling utilities to:

- Understand the current loading on the feeder
- Recognize feeders nearing their rated capacity
- Identify additional available line capacity based on prevailing conditions
- Detect local icing conditions to enhance storm operation decisions and response
- Calculate site specific line sag based on prevailing conditions

## Advanced Line Sensor



GE's advanced line sensors provide time synchronized measurements to facilitate improved situational awareness and operations including:

- Electrical current, both amplitude and phase
- Conductor surface temperature

## Weather Data



The Intelligent Line Monitoring System employs a weather station with an ultrasonic anemometer option to deliver enhanced dynamic line rating analytics using wind speed and direction averaging techniques that enable utilities to set increased circuit ratings based on a greater understanding of prevailing conditions.

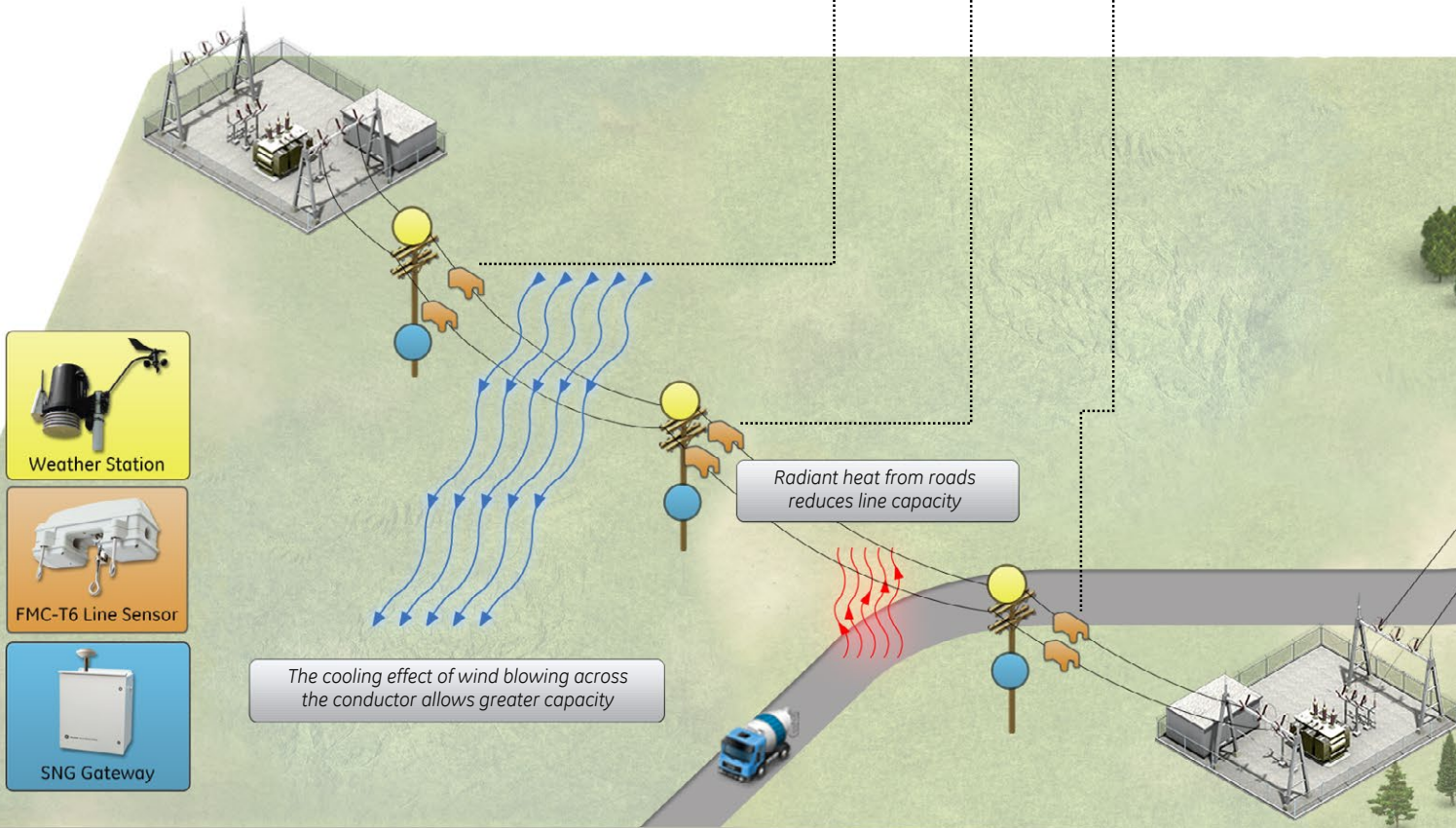
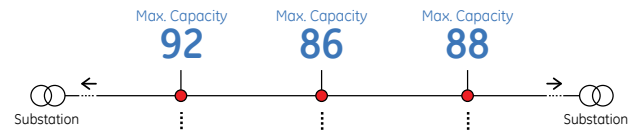

# Application Overview: Fault Detection, Location and Analysis

The Intelligent Line Monitoring System delivers the necessary field visibility and advanced analytics to:

- Capture faults in low and high impedance grounding treatments,
- Identify fault location alerting operators visually and notifying repair crews

## Advanced Line Sensor



The sensor is configured to detect fault conditions facilitating rapid identification and notification. This line mounted device measures and records the current, both amplitude and phase, at 32 samples per cycle, and communicates to the SNG via an on-board 2.4 GHz radio.

## Communications Gateway



The Sensor Network Gateway (SNG) provides a communications gateway for distribution network and weather information that is critical for advanced applications. The SNG communicates with the line sensors, weather monitoring equipment and records voltage, both amplitude and phase. The gateway is equipped with several backhaul options for communicating with the advanced applications including an embedded 2G/3G/GPRS/UMTS modem, and Serial and Ethernet communication ports.

## Fault Detection, Location and Analysis (X-NET)



- Monitors the distribution network 24/7 for events and faults
- Automatically filters events from faults based on utility defined configuration to avoid nuisance reports
- Identifies fault location alerting operators visually and notifying repair crews via email and SMS messaging.
- Provides a cycle by cycle plot of fault activity.

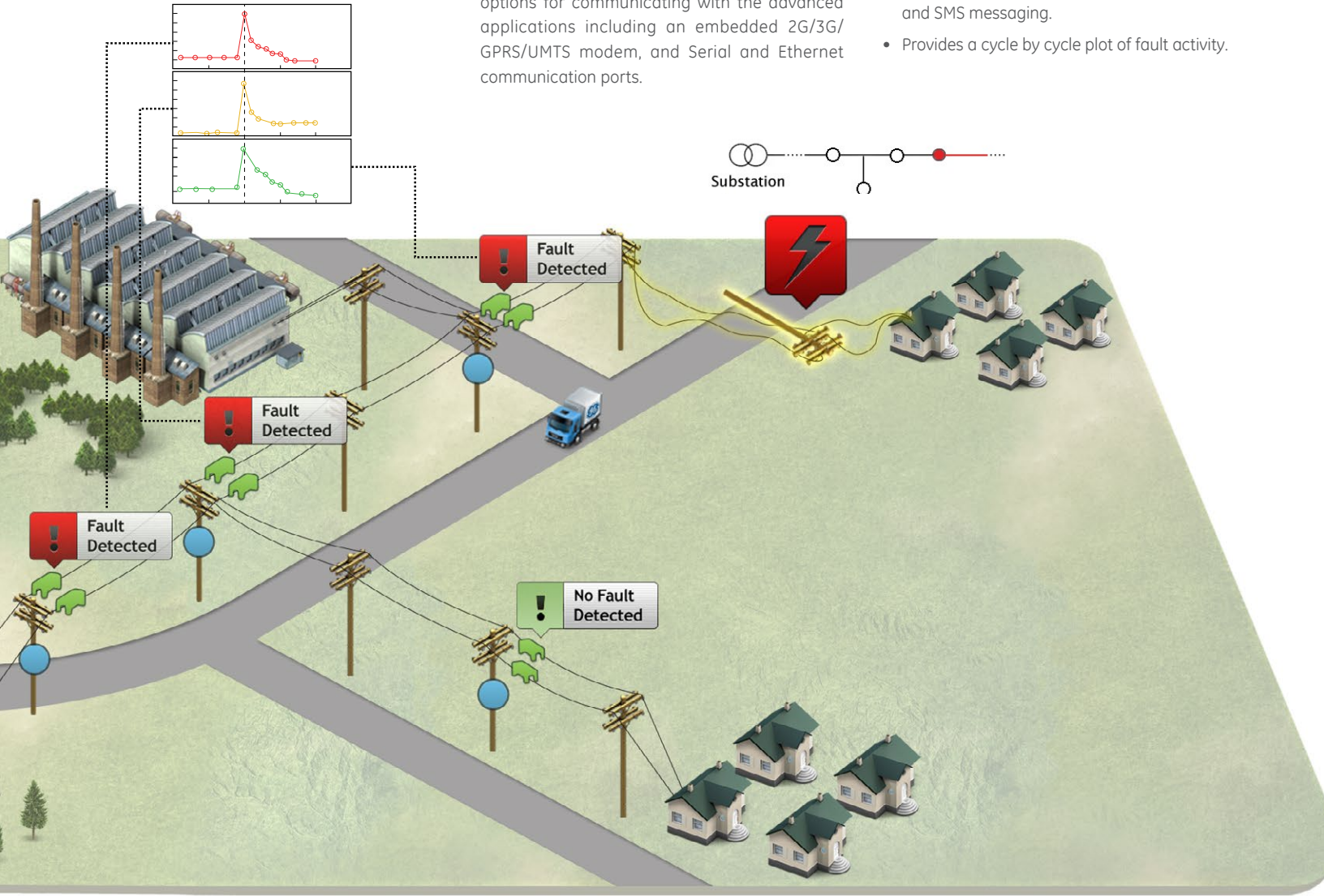

## Application Overview: Feeder Visualization

The Intelligent Line Monitoring System increases situational awareness along distribution feeders and enables utilities to operate and respond based on prevailing conditions, not static or seasonal estimates. The extended visibility delivered by the Intelligent Line Monitoring System provides actionable information enabling utilities to meet the changing dynamics of the distribution network, and be able to:

- Analyze 3 phase current along the feeder
- Balance phases to extend circuit capabilities and delay capital expenditures
- Identify conductor loading issues due to phase imbalance and take corrective action
- Identify line regulator loading issues and take corrective action

To meet the new demands posed by distributed generation and the proliferation of electric vehicles on an aging infrastructure, distribution networks have to become more efficient, robust and reliable. In order to meet these challenges, greater visibility of distribution networks is essential for operations, planning and developing new construction and protection design guidelines. The 'Smart' use of distributed intelligence has emerged as a major factor in meeting the needs of the new distribution network model, while at the same time driving enhancements in network safety and security.

## Improving Situational Awareness

GE's Intelligent Line Monitoring system is time synchronized enabling data from multiple locations along the distribution network to be aligned to within 40µS. In addition to delivering measured data in DNP3 format, GE's applications use this technique to align the values captured at the substation and along the feeder to provide a coherent image of the network performance.

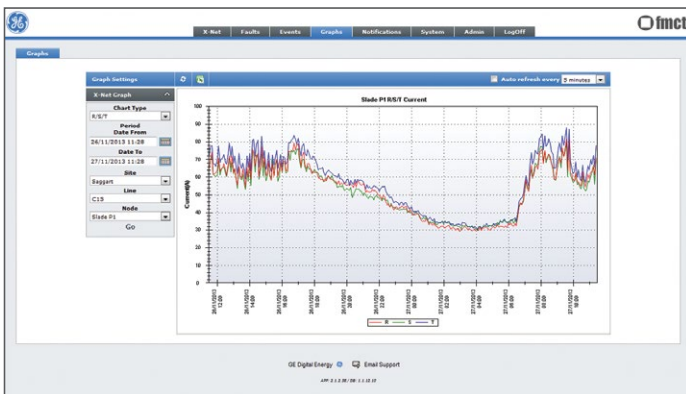

3 phase current profiling identifies magnitude of line imbalance at each measurement point



## Improving Network Efficiency and Capacity

Many distribution networks are asymmetrical due to the use of single or two phase laterals. This type of network design tends to lead to unbalanced loads with negative implications for efficiency and capacity. A balanced load seen at the substation may not be indicative of balanced circuits down the feeder. The distributed load monitoring feature of the Intelligent Line Monitoring System provides added visibility necessary to correct and improve load balance. Similarly the onset of distributed generation complicates the network further, where load and power flow direction are no longer obvious.

In addition to understanding the impact of asymmetry of the network, periodic data recorded by the system brings enhanced visibility supporting more in depth network analysis. Accurate time synchronization enables the delivery of positive, negative and zero sequence currents at each measuring location along with substation voltage. The use of load profiling is very useful as an indicator of consumption changes or patterns, giving an early indication of non-technical losses. Reporting intervals are user configurable. This enhanced network visibility delivers actionable information to enable:

- Field personnel to identify the optimum phases for laterals,
- Network planners to identify maximum loadings and assist in new load or distributed generation planning,
- Protection engineers to support more advanced relay setting techniques based on distributed information and
- Network engineers to identify where the network losses are occurring.

# Application Overview: System Diagnostics and Maintenance

The system diagnostics and maintenance applications play an important role in maintaining a high level of system performance in delivering actionable intelligence.

## System Diagnostics

The Intelligent Line Monitoring System and its ability to deliver valuable network data becomes an important component in the drive for increased network performance and efficiency. To maximize system up-time, the Intelligent Line Monitoring System constantly monitors for equipment and communication failures. The GE system diagnostics application records equipment performance and notifies the administrator by email of any detected performance issues.

System diagnostics application reports for communications:

- Time of SNG's last activity
- CSQ (2G/3G GPRS/UMTS signal strength)
- 2G/3G GPRS/UMTS modem resets
- GPS timing lock status
- Communication with weather monitoring equipment
- Communication with line sensors

System diagnostics application reports for asset health:

- Battery voltage on the SNG
- Battery voltage on the line sensors
- Charge/discharge current on the SNG
- Charge/discharge current on the line sensors

## System Maintenance

The system maintenance application provides a unified dashboard for managing and tracking key system assets. This application manages the remote firmware upgrade process for SNG's and line sensors, and displays the current firmware version installed in an SNG or line sensor. It also enables the system administrator to manage the list of recipients for SMS messages and emails relating to fault notification.

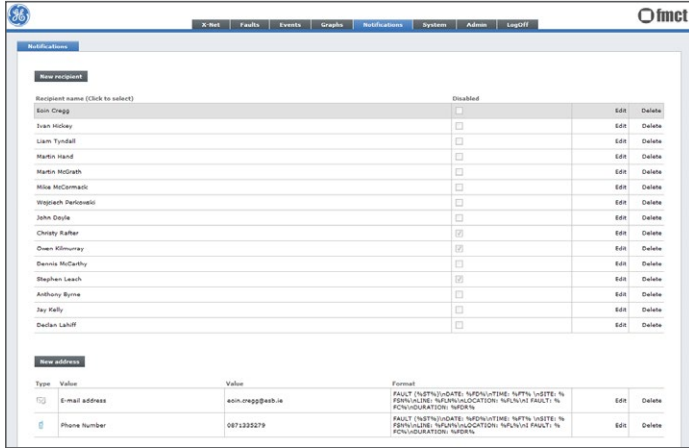

The notification management tool enables the system administrator to maintain recipients for fault notifications

## System Diagnostic Management Tool

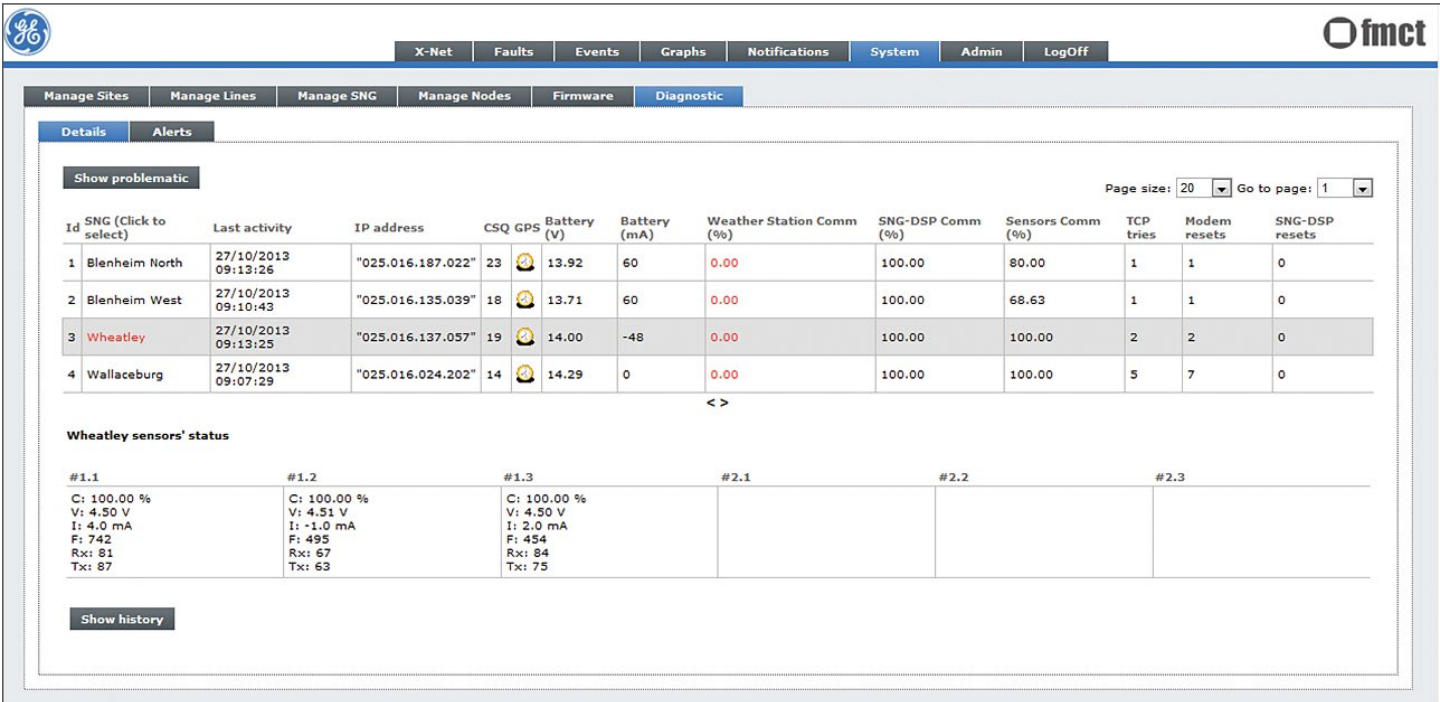

System diagnostic management tool monitors asset health

## Multilin T-NET Software: Dynamic Line Rating Analysis Application

GE's Multilin T-NET advanced analytics compute dynamic line ratings based on prevailing conditions enabling distribution utilities to better manage their feeders, avoid conductor degradation, and knowledgeably deploy sustainable generation. The Intelligent Line Monitoring System employs weather data including a weather station and/or an ultrasonic anemometer input and uses wind speed and direction averaging techniques to deliver enhanced dynamic line rating analytics enabling utilities to set increased circuit ratings based on a greater understanding of prevailing conditions.

The dynamic line rating application provides actionable information enabling utilities to:

- Understand the current loading on the feeder
- Recognize feeders nearing their rated capacity
- Identify additional available line capacity based on prevailing conditions
- Detect site specific icing conditions to enhance storm operation decisions and response
- Calculate line sag based on prevailing conditions

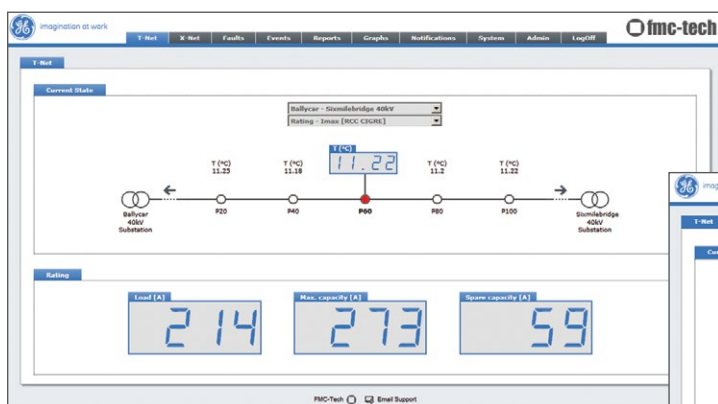

Application displays current line loading and available capacity based on the CIGRE algorithm

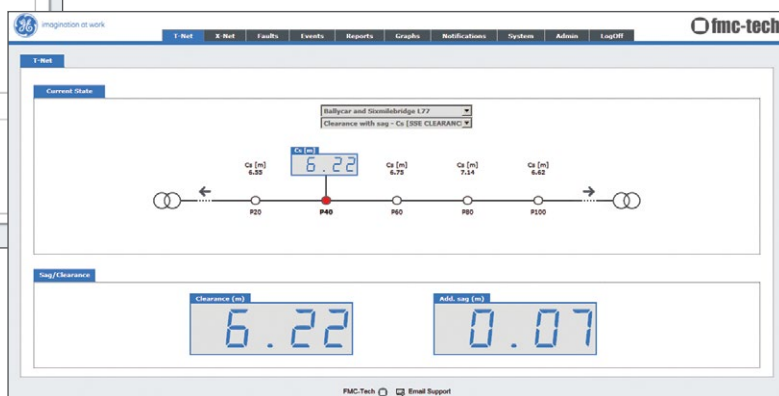

Application delivers site specific line sag and clearance for safety constraint verification and maximum line utilization

### Static Circuit Rating

Utilities have traditionally employed a single, static circuit capacity rating or seasonal rating. Yet this method does not take into account the prevailing conditions. Without this insight, circuit capacity may be underestimated, resulting in assets that are underutilized, loss of return on investment or even inability to serve a load. Conversely capacity may be overestimated, yielding potentially unsafe ground clearance conditions and/or conductor degradation.

### Calculating Dynamic Line Rating

GE's Multilin T-NET advanced analytics compute dynamic line ratings based on prevailing conditions using the CIGRE model calculation. This algorithm considers parameters such as:

- Maximum conductor temperature
- Temperature coefficient of resistance
- Conductor type
- Ambient temperature
- Speed and angle of attack of the wind

- Diameter of conductor and outer wire
- DC resistance at 20°C
- Solar radiation
- AC resistance
- Latitude and elevation above sea level

The Multilin T-NET software automatically calculates the available and maximum capacity based upon the prevailing conditions reported from the Multilin FMC line sensors, weather stations and/or ultrasonic anemometers. The dynamic line rating application displays three critical values for each node, namely:

- Present load
- Present maximum capacity
- Present available capacity

The Multilin T-NET software calculates local line sag and site specific icing conditions based upon the prevailing conditions as shown in the image above.

The Multilin T-NET software can exchange key rating values and conductor temperatures with the utility SCADA system using DNP3 or IEC 870-5-101/104 using a server to server approach. Alternatively, the measured data can be delivered from the deployed SNG devices directly in DNP3 format.



# Multilin X-NET Software: Fault Detection, Location and Analysis Application

The advanced analytics delivered by the X-NET application are designed to meet the challenges of capturing faults in both low and high impedance grounding treatments. The Intelligent Line Monitoring System delivers the necessary field visibility and advanced analytics to capture and report the location of ground and phase to phase faults in directly grounded treatments, and ground and cross country faults in high impedance grounding schemes. As an alternative measured data can be delivered from the deployed SNG devices in DNP3 format.

## Fault Detection, Location & Analysis

- Monitors the distribution network 24/7 for events and faults
- Automatically filters events from faults based on utility defined configuration to avoid nuisance reports
- Identifies fault location alerting operators visually and notifying repair crews via email and SMS messaging
- Provides a cycle by cycle plot of fault activity

## Maintenance Prioritization

The X-NET Software enables the utility to effectively prioritize maintenance expenditure by:

- Maintaining a database of events to facilitate identification of repetitive incidences, comparison of feeder performance and definition of preventive maintenance programs
- Graphically depicting outage history for each feeder section

The X-NET Application enables utilities to:

- Target where to spend maintenance funds based on performance instead of age of assets
- Direct field crews to feeder sections where maintenance is needed
- Guide maintenance work required by the nature and frequency of feeder faults indicated by frequent re-closer activity
- Categorize maintenance required based upon repetitive transients indicative of:
  - The need for tree trimming
  - Salt build-up
  - Equipment degradation

## Fault Identification

The system monitors the distribution network 24/7 for events and faults. Any network event activity that exceeds a user defined threshold and is longer than 2 cycles in duration is stored into the database and processed by the Multilin X-NET software as a network event. The system automatically filters events from faults based on utility defined configuration to avoid nuisance reports. If the outage exceeds a user defined duration, it is classified as a fault and the system proceeds to notify personnel by SMS or email. Both faults and events captured are stored in the database for future review and analysis. The Multilin X-NET software provides data mining capabilities allowing the user to define a time period and review the captured fault and event activity during this period. Results are presented graphically so that locations experiencing network problems are easily identified, supporting preventive maintenance by highlighting the most critical or problematic sections of the network.

## Fault Analysis

Notification of a fault in the network is triggered in one of three ways: when a line sensor detects that the load has exceeded the maximum user configured threshold or fallen below its minimum user configured threshold or when a substation SNG monitoring open delta voltage exceeds its maximum user configured threshold (applicable in high impedance grounding scenarios). Upon notification the X-NET software selects the substation identified as the source of supply to the fault and polls the sensors installed along the feeders obtaining 10 cycles of current data on either side of the event time stamp in order to provide a complete picture of the faulted network. The X-NET software analyzes the data received and displays the section where the fault has occurred. When the fault condition is resolved and power is restored, the sequence is reversed and the graphical display is cleared.

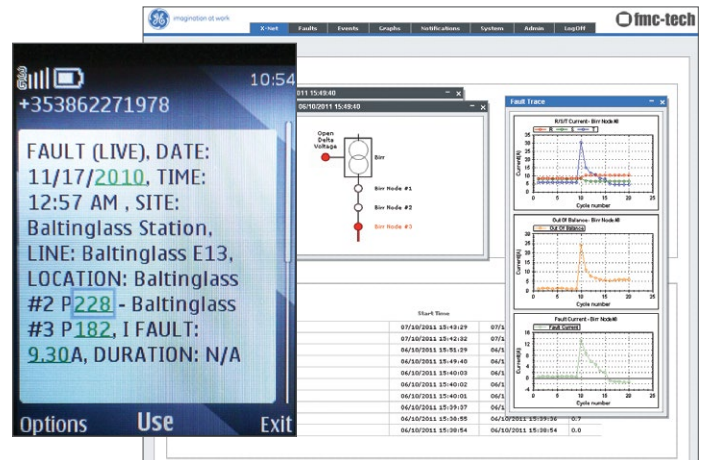

Fault notifications are sent directly to field crews mobile devices

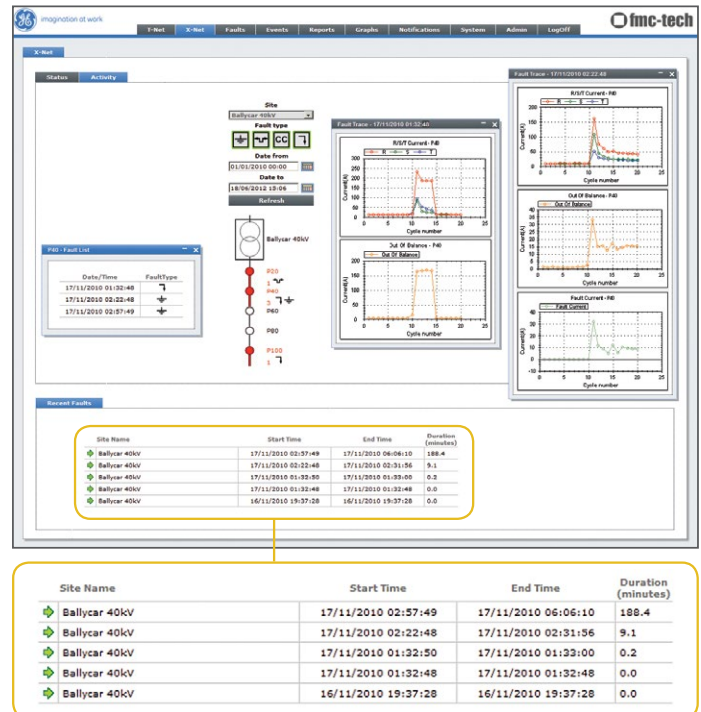

Support maintenance prioritization based on fault history activity for feeder segments

## Installation

### Multilin FMC Line Sensor

Installation of the Multilin FMC line sensor can be completed in just minutes on a live line using either hot-stick or hot-glove. Sensors can be installed on 480V to 140kV feeders and will sit on conductors ranging from 10 mm to 28 mm in diameter. The sensor commences operation as soon as it is closed around the conductor and a small flashing LED mounted in the sensor housing indicates that it is operational. The magnetic field of the line provides the power for the sensor and also charges a 48 hour battery back-up that keeps the sensor operational in the event of an outage.

The sensor can be supplied with a temperature probe fitted on a flying lead that measures the surface temperature of the conductor. The lead is wrapped around the conductor with its temperature sensing tip at the end of the lead tied to the conductor surface. To ensure that the probe is thermally coupled to the conductor, GE recommends that a thermal compound is used between the conductor and the probe tip (please refer to the sensor installation instruction manual).

### Multilin SNG Sensor Network Gateway

The SNG can be installed along the distribution feeder communicating with the line sensors or in a substation for voltage monitoring. Radio range between the line sensors and the SNG is typically 30 meters/100 feet, and the SNG is normally mounted on the same pole or structure underneath the sensors. The SNG is a low power device and can be powered by a solar panel or by a 100V/250V AC power supply. GE offers a solar kit option (see Ordering Codes section).

### Software

There are three options for the system software:

- Measured data only in DNP3 format to head end systems.
- Applications running on a GE hosted server with a server to server link if required (DNP3/IEC101/104)
- Applications running on a customers server with a server to server link if required (DNP3/IEC101/104)

### Communications

The SNG supports several backhaul options for communicating with the advanced applications, including cellular as well as serial and Ethernet communication ports. Equipped with a SIM card holder, the SNG enables 2G/3G GPRS/UMTS backhaul communications. The serial cables from the weather station and/or ultrasonic anemometer can be connected to the SNG to enable transmission of weather data. The gateway supports two way communications with the line sensors by 2.4 GHz radio and no special installation is required.

### System Overview

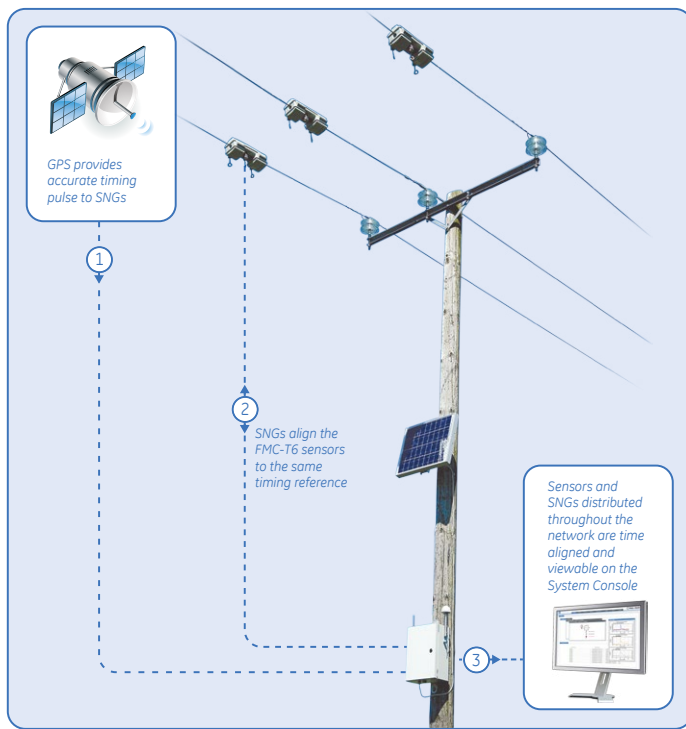

Typical feeder measurement installation

### System Network Model

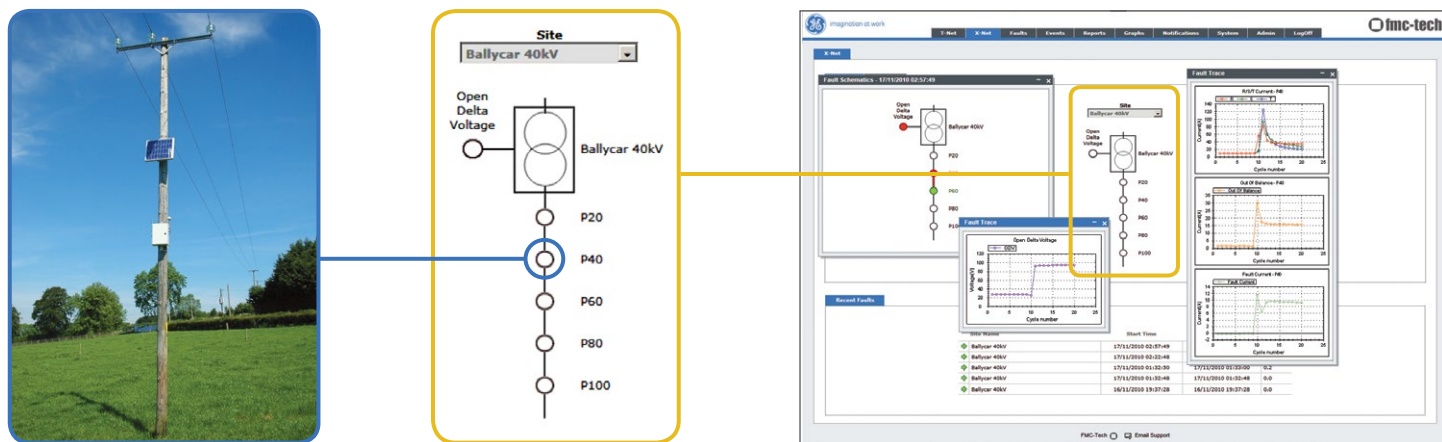

The system network model enables utilities to collect, view and report asset information graphically, creating feeder visualization

## Application Data Specifications

MULTILIN FMC-T6	PERFORMANCE
Current Range	2 Versions 300A or 600A
Current Measurement Accuracy	+/- 1% of Amplitude Plus 0.3A
Phase Accuracy	+/- 0.6°
Conductor Temp Measurement Range	-10°C to +85°C
Accuracy of Conductor Temperature Probe	+/- 2°C
Measurement Sampling Rate	32 Samples per Cycle
Minimum Line Current to Power the Sensor	10A 300A Version / 30A 600A Version
Line Voltage Range	480V to 140kV
Sensor Radio Frequency	2.4GHz
Sensor Radio Range	30m/100ft Line of Sight
Flash Memory	80 Minutes of Data
Battery Back-Up	Maximum 48 Hours With a Fully Charged Battery
Operating Temperature Range	-40°C to +65°C
Weight	5.8kg/12.8lb

MULTILIN SNG	PERFORMANCE
Voltage Measurement Accuracy	0.5% of Reading +/- 0.5% of Full Scale
Voltage Phase Accuracy	+/- 0.6° (voltage values above 10V)
Radio Range to Line Sensor	30m/100ft Line of Sight
Battery Backup	48hrs at 25°C
Operating Temperature Range	-40°C to +65°C
Data Size	150 MB per month (Typical)
Data Storage	48 Hours (At a Monitoring Interval of 5 Minutes)

SYSTEM OPTIONS	STANDARD	OPTIONAL
GPS Location and Timing	•	
2.4 GHz Radio	•	
Davis Weather Station Port	•	
Ultrasonic Anemometer Port	•	
2G/3G (GPRS/UMTS) Backhaul Communications	•	
RS232 Serial Port for Backhaul Communications	•	
Ethernet Port for Backhaul Communications	•	
Open Delta Voltage Input (High Impedance Grounding Treatment)	•	
Three Phase Voltage Input	•	
Standard Pole Mounting Bracket	•	
LV AC Supply (Input 85-250Vac 50/60 Hz)	•	
DC Power Supply Nominally 24V DC (22.5V DC - 30V DC)	•	
Feeder Visualizer Software	•	
Measured data in DNP3 format	•	
Multilin X-NET Software Application		•
Multilin T-NET Software Application		•
Solar Panel & Battery Kit		•
Standard Weather Station Kit		•
Ultrasonic Anemometer		•

## System Management Specifications

SYSTEM CONFIGURATION AND MANAGEMENT TOOLS	DESCRIPTION
SNG Firmware	Remotely Upgradeable
Sensor Firmware	Remotely Upgradeable
Monitoring Frequency	Remotely Upgradeable
Fault Detection Threshold	Remotely Upgradeable
SCADA Integration	Server based (DNP3/IEC101/104) Measured data in DNP3 format
Fault Notification	Remotely Configurable (SMS & Email)
Network Modeling	Server based Tool

## Software Specifications

SOFTWARE SPECIFICATIONS	DESCRIPTION
Feeder Visualizer (Standard)	Reports: <ul style="list-style-type: none"> <li>Individual Phase, Positive and Negative Sequence Currents</li> <li>Substation Bus Phase Voltage</li> <li>Open Delta Voltage</li> <li>Conductor Temperature*</li> <li>Wind Speed, Direction, Dew Point and Solar Gain**</li> </ul>
Multilin X-NET Application	Detects and Reports at Each Node: <ul style="list-style-type: none"> <li>Earth Faults in High Impedance Grounding Treatments</li> <li>Over Currents, (Earth Faults in Low Impedance Grounding Treatments and Phase to Phase Faults)</li> <li>Under Currents (Dropped Phase or Phases and Outages)</li> </ul>
Multilin T-NET Application	Calculates and Reports at Each Node: <ul style="list-style-type: none"> <li>Dynamic Rating of Conductor (Cigre Model)**</li> <li>Sag/Clearance*</li> <li>ICE Load Warning (Rime)***</li> </ul>

\* Requires Multilin FMC sensors with temperature probes.

\*\* Requires weather monitoring equipment.

\*\*\* Requires Multilin FMC-T6 sensors with temperature probes and weather monitoring equipment.

## Certifications

ISO	Manufactured under an ISO9001 registered program
CE	Conforms to: 2004/108/EEC EMC Directive December 2004 2006/95/EC Low Voltage Directive December 2006 1999/5/EC Radio equipment and telecommunications terminal equipment Directive R&TTE March 1999

## Type Tests

Document No.	Title	Edition / Issue
2004/108/EC	EMC Directive	Dec 2004
2006/95/EC	Low Voltage Directive	Dec 2006
1999/5/EC	Radio Equipment and Telecommunications Terminal Equipment Directive R&TTE	March 1999

# Ordering Codes

SENSOR				
FMC-T6 -	*	*	*	Description
Type	0			Without Temperature Probe
	1			With Temperature Probe
Frequency		0		50Hz
			1	60Hz
			2	50/60Hz <sup>1</sup>
Current Range			0	300A
			1	600A

<sup>1</sup> Option available for SNG2 models only.

SNG		
SNG-2-	*	Description
Type	0	Standard

WEATHER STATION		
WKIT -	*	Description
Type	B	Standard Weather Station Kit
	C	Ultrasonic Anemometer <sup>2</sup>

<sup>2</sup> Please Note: For T-NET application a Standard Weather Station is required in addition to the Ultrasonic anemometer.

MULTILIN T-NET HOSTED SOFTWARE		
T-NET -	*	Number of Nodes
Type	1	1 Node
	2	5 Nodes
	3	10 Nodes
	4	25 Nodes
	5	50 Nodes

MULTILIN X-NET HOSTED SOFTWARE		
X-NET -	*	Number of Nodes
Type	1	1 Node
	2	5 Nodes
	3	10 Nodes
	4	25 Nodes
	5	50 Nodes

SNG SOLAR SUPPLY KIT		
SKIT-	*	Description
Type	0	30W Solar Supply Kit
	1	70W Solar Supply Kit

ON LINE TRAINING MODULES		
TM-	*	Description
Type	0	Module 1 Installation
	1	Module 2 System Set-Up
	2	Module 3 Controller Set-Up
	3	Module 4 Server Installation
	4	Module 5 SCADA Integration

REMOTE COMMISSIONING SUPPORT		
CS-	*	Description
Type	0	1 Day Support
	1	2 Days Support

GE Digital Energy  
 650 Markland St.  
 Markham, ON  
 Canada L6C 0M1  
 Toll Free (NA Only): 1-800-547-8629  
 Tel: 905-927-7070  
 Fax: 905-927-5098

[GEDigitalEnergy.com](http://GEDigitalEnergy.com)

Microsoft is a registered trademark of Microsoft Corporation.  
 GE, the GE monogram, Multilin, FMC-T6, FMC-T4, SNG, X-NET and T-NET are trademarks of the General Electric Company.

GE reserves the right to make changes to specifications of products described at any time without notice and without obligation to notify any person of such changes.

© Copyright 2015, General Electric Company. All Rights Reserved.



GEA-12689D(E)  
 English  
 151019