

ORBIT 60 SERIES System Overview

Datasheet

Bently Nevada Machinery Condition Monitoring

137M5182 Rev. K



Plant-wide • One System

The Orbit 60 Series Protection and Condition Monitoring System provides one continuous, online monitoring system for both critical and plant-wide applications.

Cyber Secure • Data Isolation

Orbit 60 Series data isolation creates a safe industrial data environment designed to meet ISA 62443 with world class network security features and segregation of protection and condition monitoring functions.

Modular • Flexible • Scalable

The Orbit 60 Series system is deployable in any combination of rackmounted and distributed hardware. This provides for better alignment of instrumentation to the machinery application.

High Speed Process Data Integration

Next generation architecture facilitates full bi-directional communications with plant control systems over a suite of standard protocols.

Extended Field Wiring Length

With the Orbit 60 Series distributed architecture, connection of multiple chassis through Bridge modules decreases overall electrical installation costs, reduces analog ground loops and noise issues, and moves key maintenance activities further from hazardous areas.

Industry Leading System Capabilities

The Orbit 60 Series supports monitoring of one or multiple machine trains in a single deployment. One System Interface Module (SIM) defines each system and can encompass up to 88 dynamic channels and 4 chassis* using Bridge modules to link them.

* Initial release supports 48 dynamic channels with 1 chassis.

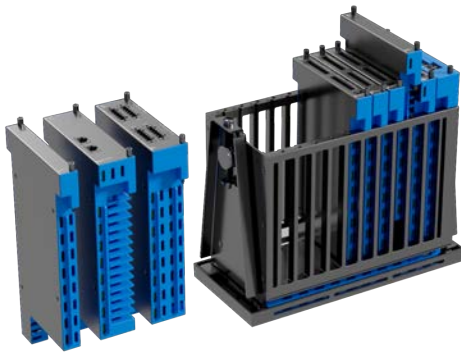

*Embedded display will not be available in first release.



Overview

The Orbit 60 Series Protection and Condition Monitoring System provides a single platform for the continuous online monitoring of both critical and plant-wide applications. The Orbit 60 Series system is deployable in any combination of rackmounted and distributed hardware, with Bridge modules creating a seamless connection between chassis to make a single system.

The table below gives a general overview of the components that make the Orbit 60 platform.

Table 1: Component Modules

System Modules	User Guide (142M9080)	Chassis	3U Chassis- 19 general purpose slots 6U Chassis -28 general purpose slots 3U Mini Chassis- 10 general purpose slots
		Power	Power Interface Module (PIM)
		Processors	System Interface Module (SIM) Protection Processing Module (PPM)
		Connect	Bridge (BRG)*
CMM	User Guide (148M9082)	SI Interface	Condition Monitoring Module (CMM)
CGW	User Guide (148M9083)	Comms	Communication Gateway (CGW) - Modbus (Ethernet or Serial*)
Input Modules	User Guide (137M0804)	Dynamic 4-channel	Negative Dynamic Input (PAV, PAS*, PAA, PAD*, KPH) (provides power for negatively powered transducers)
			Positive Dynamic Input (PVT*) (provides power for positively powered transducers)
			Linear Variable Differential Transformer (AC LVDT*)
RTD/TC, Process, Discrete	User Guide (157M8568)	Static 6-channel	RTD/TC Temperature (RTD) Isolated TC Temperature (ITC*) Isolated Discrete Input or Process Variable (PVD)
Output Modules	User Guide (146M5032)	Relays 8-channel	ElectroMechanical Relays (EMR) Solid State Relays (SSR)
		Rec Outs 8-channel	Recorder Outputs (REC*)
Display and CPU	User Guide (137M0702)	Display	External Display (EXD)

* Modules not available in first release.

Orbit 60 System Level Diagram

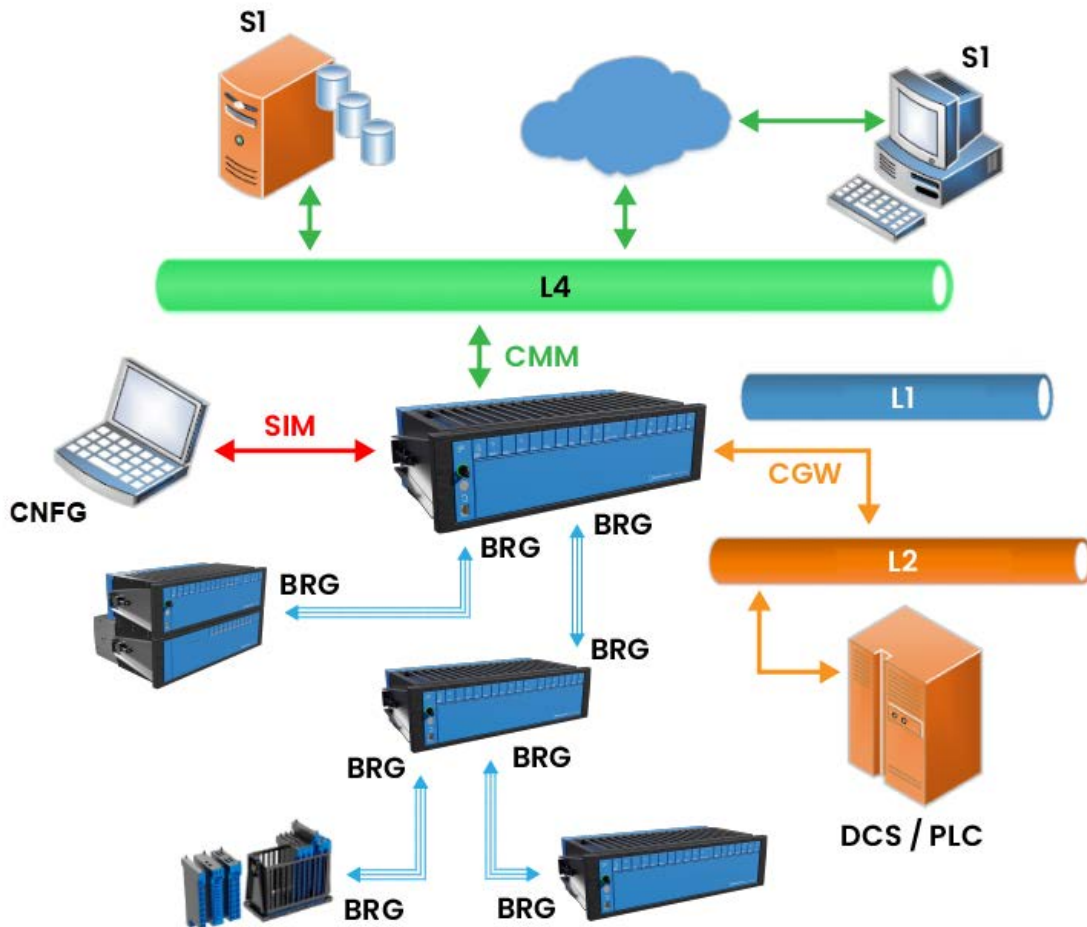

SIM - System Interface Module

CMM - Condition Monitoring Module

CGW - Comm Gateway Module

BRG - Bridge Module*

S1 - System 1 Server or Client

CNFG - Orbit Studio Configuration Software

DCS/PLC - Distributed Control Systems/
 Programmable Logic Controller

L1 - Unit Network **L2** -Control Network

L4 - Business Network

Figure 1: System Diagram

One System Interface Module (SIM) defines a system of up to 88 dynamic channels*, accommodating multiple machine trains and supporting unrestricted synchronous Keyphasors for any channel. The Condition Monitoring Module (CMM) interfaces to the business network through a cyber-secure access port. The Communications Gateway (CGW) sends (data, status, setpoints) and receives (inhibit, reset, trip multiply)* high speed process data with the control systems. Bridged (BRG) connections allow up to 3 chassis to act as a single system while decreasing overall installation costs, reducing ground loops, and minimizing electrical noise.

* Features not available first release.

Orbit 60 Series Chassis

You can flexibly deploy each chassis option with a public facing side (for rack or panel mounts) and a utility side (for wiring connections and bulkhead mounts). Insert modules and make all wiring connections from the utility side. Provisions for the public side of the chassis include status LEDs, configuration port, Config/Run key, and reset button. Three chassis types are available.

Chassis Types

3U, 10-Slot *
(Bulkhead or Panel Mount)

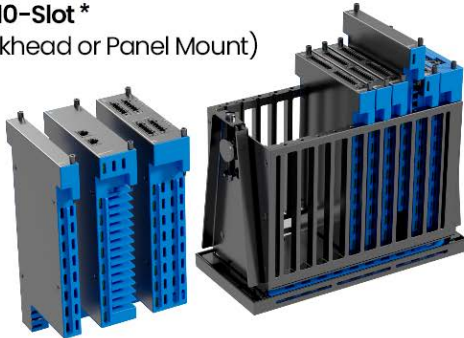

6U, 28-Slot *
(Bulkhead, Rack, or Panel Mount)



3U, 19-Slot
(Bulkhead, Rack, or Panel Mount)

Note: Embedded display will not be available in first release.

Mounting Options

- **Panel Mount** – Mounts to rectangular cutouts in panels and secures to the panel using clamps supplied with the chassis in 3U Mini*, 3U 19" standard, and 6U 19" standard* configurations. The 6U 19" will fit in the space of a 3500 rack.*
- **Rackmount** – Mounts the 3U or 6U chassis on 19-inch EIA rails. Two 3U units or a single 6U* form factor have been designed to fit within the space of a single 19" rackmount 3500 unit, as a retrofit.
- **Bulkhead** – Typically mounts into a protective enclosure fastened to a sub panel in 3U Mini*, 3U 19" standard, and 6U 19" standard* configurations. NEMA 4 and 4X weatherproof housings are available when required for environmental protection or when purge air is used.

* Features not available in first release.

Front Panel Options

There are two Orbit 60 Front Panel Module options.

Standard Front Panel Module

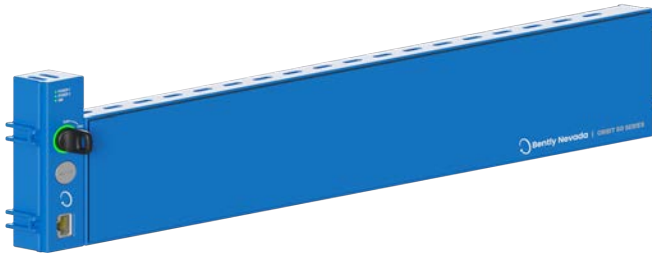

The Standard Front Panel Module is for Orbit 60 chassis that have a SIM module installed.

Remote Front Panel Module*

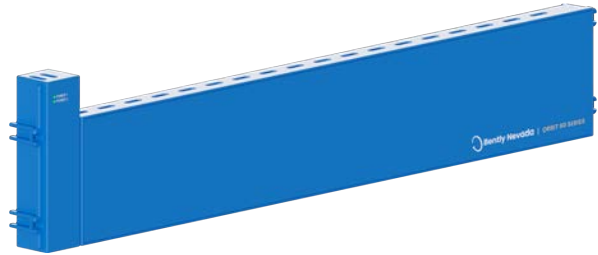

The Remote Front Panel Module is for Orbit 60 chassis that do not have a SIM module installed. The Remote Front Panel displays the status of the power supplies.



Statuses

The Standard Front Panel Module shows the status of the power supplies and the presence and operation of the SIM Module.

Key Switch



This front panel can send run or program requests via the key switch. When the key is in the RUN position, the ring lights green and the protection system is engaged, but when the key is in the PRG, or program mode, the ring lights amber and system configuration changes can be made through Ethernet connection to the SIM.

Reset

A RESET button is located on the Standard Front Panel.

Ethernet

An RJ45 jack provides Ethernet connection to the SIM for external display or configuration tasks from the public side of the system.

* Not available in first release.

System Interface Module



Each Orbit 60 system requires a single System Interface Module (SIM). The SIM provides the user access to manage protection configuration, local display, system-level diagnostics, system LEDs, system contacts, and the system protection fault relay. The SIM occupies one slot and must be adjacent to the Power Input Module (PIM) in the chassis.

The SIM is the access point for configuring and maintaining the system. The module communicates to the Orbit Studio configuration software and transmits the configuration to other modules in the system. The SIM provides a physical access security feature through a key-lock switch on the public side and a contact on the utility side of the SIM. Either of these controls can be used to secure the system configuration, preventing unauthorized changes.

The SIM has 3 independently configurable ethernet ports, each port can be used for system configuration, system time synchronization, temporary troubleshooting, or an external display.

Communication Gateway Module

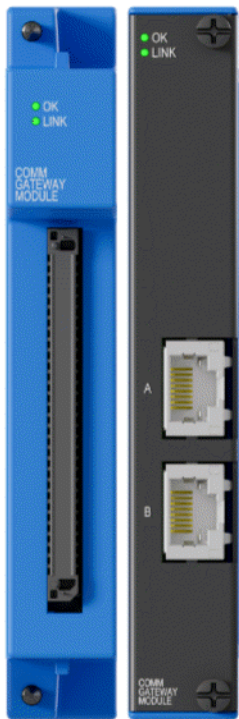

The Communication Gateway Module (CGW) provides information to external hosts including measurements, alarms, statuses, and configuration information using standard industrial protocols. The CGW is designed to be used as part of a protection loop.

Through the Communication Gateway module, the system can acquire process data from external control systems, human interfaces, and data historians. The data can also be passed through to System I. The Communication Gateway module occupies a single slot.

There are two versions of the CGW module:

- **Serial*** - RS-485 port supporting Modbus protocol*
- **Ethernet** - Two RJ-45 ethernet ports supporting Modbus and EGD* protocols

* Features not available in first release.

Protection Processing Module



The Protection Processing Module (PPM) serves as the computational engine for the Orbit 60 monitoring system. It extracts all machinery measurements for the protection system and performs alarm determinations. The PPM analyzes signals from transducers, generates measurements \ statuses and publishes them to other modules for data collection and external communication. Each PPM occupies a single slot within the system.

Each PPM provides capacity for a large number of sensors and can support typical monitored machine trains. The PPM capacity is a function of the type of processing required on each input. If the system requires more processing than a single PPM can provide additional PPMs can be added to the system for complex monitoring deployments. . For protection systems, redundant PPMs are recommended.

The Orbit Studio Configuration Software provides a System Utilization Calculator to evaluate the remaining capacity of the PPMs in your system. If your processing capacity reaches 90%, a warning indicator displays and we recommend adding another PPM, or 2 PPMs if the system is redundant.

Condition Monitoring Module



The CMM listens to all information within the system, including all measurements, waveforms, digital transducer signals, system controls, status information, system configuration information, process data from external systems, and alarm and events logs. It only listens, with no capability to write, allowing interface to System 1 over the business networks, with no risk to the protection system.

Each module occupies two slots within the system. Placing multiple CMM modules allows the connection of two independent System 1 clients to the Orbit 60 System. Data is transferred to System 1 continuously, but in the event the connection is lost or System 1 is not utilized, non-volatile storage buffers historical data until the information is off-loaded to the host software. System 1 can configure the CMM module to extract additional measurements and waveforms from system sensor data.

Bridge Module (BRG)*



The base-to-base Bridge module connects multiple chassis to make a distributed system. Bridge connectivity enables flexible deployments in linear or star topologies. The Orbit 60 System significantly reduces field wiring cost, especially when extending to remote locations. Each Bridge module communicates all data in the local chassis and replicates to the remote chassis. In this way, the system communicates all data within the system to all devices in the system.

The Bridge module provides protection from incompatible networks interfering with the operation of the system by blocking any transmissions from non-approved sources onto the chassis.

* Module not available in first release.

Power Input Module



The Power Input Modules (PIM) always reside in a special-purposed slot located in the first slot of the chassis. This slot accommodates two PIMs for redundancy. At least one PIM must power every chassis, and every chassis requires its own PIMs and power sources. Redundant PIMs and power sources are strongly recommended.

The PIM is a half-height module that connects an external power source to the system. Each Orbit 60 Series chassis supports two stacked redundant power input modules. Failure of one power source does not affect the operation if the system uses both power inputs. The PIM employs out-of-range protection for miswiring, overvoltage, and overcurrent protection for the input power sources.

The PIMs support input voltages ranging from +21 Vdc to +32 Vdc. The most common power source comes from external DIN rail mounted AC/DC +24 Vdc output power

supplies. The Instrument Common (IS) and Protective Earth  connections for the system are made at the utility side of the PIM. External redundant power supplies are recommended for the system.

Remove and insert a single Power Input Module without disrupting system operation, as long as another PIM remains installed and connected to its input power source.

For detailed information on required Power Supply see associated datasheet (142M8947).

Dynamic Input Modules



The primary purpose of the Dynamic Input module is to digitize the sensor signal at a rate that completely encompasses the signal content and provides transducer power for various sensors. The Orbit 60 Series Dynamic Input module is a 4-channel input module available in both negative and positive dynamic input options. The inputs are also used for speed or Keyphasor signals.

Negative Transducer Input Module

These cards work with negative-voltage external sensors offering four variants:

- **PAV** Negative Dynamic Sampler (Prox, Accel, Velom)
- **PAS** Negative Dynamic Sampler (Prox, Accel, Seismic) *
- **PAA** Negative Dynamic Sampler (Prox, Accel, Aero)
- **PAD** Negative Dynamic Sampler (Prox, Accel, DC LVDT) *

Positive Transducer Input Module

The Positive Voltage (PVT) input module interfaces with industry-standard third-party ICP sensors, as well as sensors that use a 3-wire (power, common, signal) or a custom 2-wire (A/+ and B/-) positive-voltage interface.

- **PVT** Positive Dynamic Sampler (Prox, Accel, Velom) *

* Modules not available in initial release.

Connectors

The Dynamic Input module uses an ix Industrial connection to provide access to four buffered transducer output (BTO) connectors for each of the dynamic channels, with short circuit protection. The ix Industrial connection is available on the public and utility side of the module.



High Speed Keyphasor Input Module

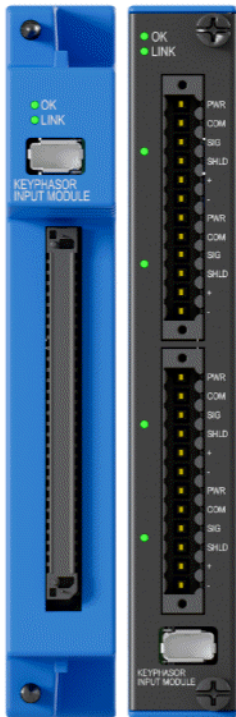

Unlike previous systems, the Orbit 60 Series system supports Keyphasor configurations for any dynamic input channel through the PAV, PAS, PAA, and PAD input modules. For high-phase accuracy applications (over 12,000 rpm) the high speed Keyphasor module can support four transducer inputs per module. Input configurations to this module can also serve as prox-vibration inputs. The Keyphasor input module occupies a single slot.

You can configure any channel on the module as a once-per-turn Keyphasor or a multiple-event-per-turn speed signal from a rotating shaft or gear used to provide a precision timing measurement. The Keyphasor Input Module works with the following transducers:

- Magnetic pickup
- 3-wire Prox
- 3-wire Accel

AC LVDT Input Module*

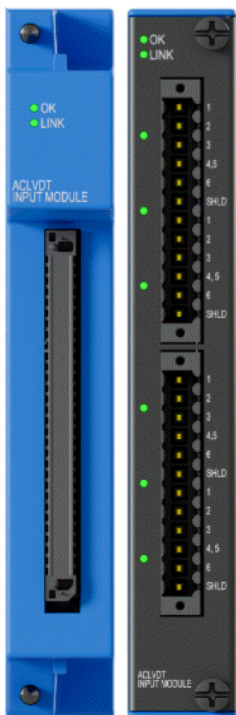

The Orbit 60 Series AC LVDT Input Module provides inputs to interface with four AC Linear Variable Differential Transformers for position measurements. The module's primary use is the measurement of case expansion and valve position. The AC LVDT input module occupies a single slot.

The four AC LVDT configured channels can connect to a:

- 4-wire AC LVDT
- 5-wire AC LVDT
- 6-wire AC LVDT

* Module not available in first release.

Temperature Input Modules



TC/RTD Temperature Module

The primary purpose of temperature modules is to interface to the temperature transducers and convert the signal into a digital representation. These modules condition and digitize the inputs at a rate that completely encompasses the signal content and allows for removal of typical noise sources.

The Orbit 60 Series TC/RTD Temperature Input Modules provide six channels of either Thermocouple (TC) or Resistive Temperature Detector (RTD) temperature input sensors.

Each channel of the Orbit 60 Series TC/RTD input module is individually configurable for sensor type and range using Orbit Studio configuration software.

TC sensors - The thermocouple configured channels provide cold junction compensation for any J, K, E, or T Type Thermocouple.

RTD sensors - The RTD configured channels can be connected to a 3-Wire 100 Ohm Platinum 0.00392 RTD, 3-Wire 100 Ohm Platinum 0.00385 RTD, 3-Wire 10 Ohm Copper RTD, or 3-Wire 120 Ohm Nickel RTD.

The RTD/TC inputs reference the internal system ground, and for this reason, should only connect to transducers isolated at the sensing end.

Isolated TC Input (ITC)*

The Orbit 60 Series Isolated Thermocouple Temperature Input modules provide six channels of temperature input sensors. The module conditions and digitizes input at a rate that completely encompasses the signal content and allows for removal of typical noise sources.

Each channel of the Orbit 60 Series TC input module is individually configurable for sensor type and range. The thermocouple configured channels provide cold junction compensation for type J, K, E, or T thermocouple.

* Module not available in first release.

Isolated Process Variable / Discrete Input Module (PVD)

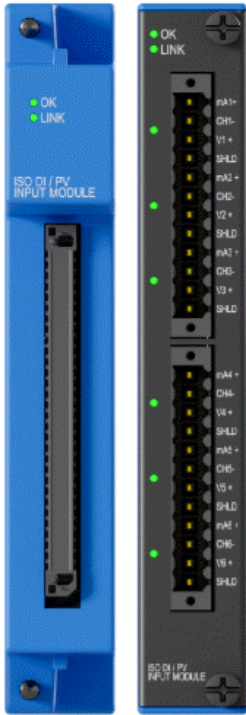

The Orbit 60 Series Isolated Process Variable and Discrete (PVD) Input module processes machine-critical parameters such as pressure, flow, temperature, and levels that merit continuous monitoring. The module conditions and digitizes the signals so the result can be compared with user-programmable alarm setpoints. The user can program the PVD module using the Orbit Configuration software to perform current, voltage or discrete input measurements. This module provides discrete inputs for essential operational commands, such as Trip Multiply for machine start-up and Alarm Inhibit.

The monitor accepts +4 to +20 mA current inputs or any proportional voltage inputs between -10 Vdc and +10 Vdc, in addition to monitoring “dry” or “wet” contacts which can be a sensor, switch, or relay.

* Process Variable measurements are not available in the first release.

Recorder Outputs (REC)*

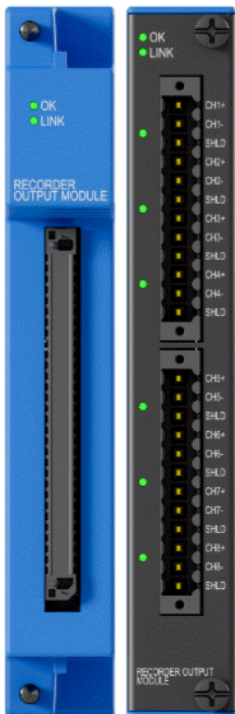

The Recorder Output module is an 8-channel module that converts measurements within the Orbit 60 Series to a proportional current or voltage output that can be connected to external systems for communications purposes.

Recorder Output modules can be configured to represent any measurement provided within the system. This module occupies a single slot.

These outputs adhere to Namur 43 specification and indicate Not OK conditions. This module is available for SIL applications.

* Module not available in first release.

Relay Modules



Program Relay modules to actuate based on alarm conditions defined in other modules. Use standard logic elements (True AND, Normal AND, OR and NOT) to combine various alarms and statuses (alarm statuses, OK statuses and other statuses (Bypass, Protection State, Inhibit, Attention, Protection Fault, etc.) into relay activation conditions. Use Orbit Studio to program the voting logic.

Relays can operate as a system or group protection fault relay, if programmed to do so, especially when the protection fault relay on the SIM does not provide adequate granularity of system health – typically for multiple machines in one system.

Pairs of relays within the module function as a single Double-Pole, Double-Throw relay when appropriately configured. All relay types are available for SIL system implementation.



Electromechanical Relay (EMR)

(Refer to the image above)

This relay drives a load directly, or through, an interposing relay. This module takes two slots. It features **8 Epoxy Sealed, Single-Pole Double-Throw Electromechanical Relays**. This module supports an AC voltage range of 5-250 Vac for loads of 100 mA to 4 A. The module also supports DC voltages and loads of 5-30 Vdc at 4 A.

Solid State Relay (SSR)

(Refer to the image left)

This relay connects to an external system's discrete input for low current communication. It occupies a single slot and features **8 Solid-State Relays**. This module supports secondary voltages up to 125 Vdc and loads of 0.1-125 mA.

Input Module Sensors and Measurements

Sensor Type Supported	Measurement Type	Dynamic Input Module Type (4 channels)							Static Input Module Type (6 channels)		
		PAV	PAS	PAA	PAD	PVT	KPH	AC LVDT	RTD	ITC	PVD
Proximitors (3-wire)	Displacement	X	X	X	X	X	X				
Accelerometer (3-wire)	Acceleration ¹	X	X	X	X		X				
HTVAS High-Temp Velocity Accel	Acceleration ^{1,2} Velocity ^{1,2}			X							
86517 and 86497 Interface Modules	Acceleration ¹ , Velocity ¹ , Dynamic Pressure			X							
350500 Charge Amplifier	Dynamic Pressure	X	X	X	X						
350501 Charge Amplifier	Acceleration ¹	X	X	X	X						
Velomitor (2-wire)	Velocity ^{1,2}	X					X				
Seismoprobe (2-wire)	Velocity ^{1,2}		X								
Proximitors Keyphasors (3-wire)	Speed, Gap	X	X	X	X		X				
IEPE Positive Constant Current (370300) (2-wire)	Acceleration ^{1,2} Velocity ^{1,2} , Dynamic Pressure						X				
Negative Biased Constant Current (2-wire)	Acceleration ^{1,2} , Velocity ^{1,2} , Dynamic Pressure	X									
DC LVDT	Position				X						
AC LVDT	Position							X			
TC - Type J, K, E, T	Temperature								X	X	
3-wire RTD	Temperature								X		
4-20 mA	Current										X
-10 V to +10 V	Voltage										X

Sensor Type Supported	Measurement Type	Dynamic Input Module Type (4 channels)							Static Input Module Type (6 channels)			
		PAV	PAS	PAA	PAD	PVT	KPH	AC LVDT	RTD	ITC	PVD	
Dry/wet contacts	Open/Closed											X
Magnetic Speed Pickups	Speed	X	X	X	X		X					

¹ Designates the ability to integrate these measurements to provide additional measurement types.

² These sensors can be configured using a Custom transducer configuration.

External Display

The external display utilizes an industrial computer connected to the SIM via Ethernet. The computer and display placement varies based on application needs. The 10.4", 15", and 21.5" VGA touchscreen displays provide excellent viewing quality for industrial applications. The 10.4" display is suitable for use in hazardous area locations across the world. The 15" display is certified for hazardous areas for North America only. The 21.5" display is intended for non-hazardous (safe) area applications only.

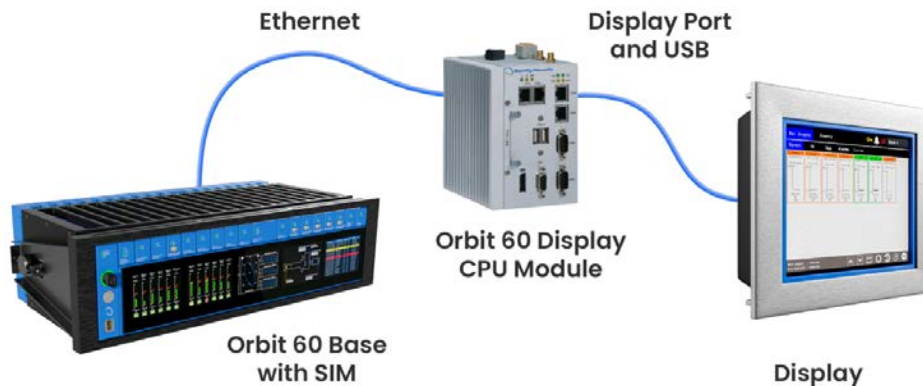

Display Mounting Options

You can mount the displays in a remote enclosure, panel, or rack.

- **10.4" Display** Can be mounted in a rack, panel, and enclosure.
- **15" Display** Can be mounted in a rack, panel, and enclosure.
- **21.5" Display** Can be mounted in a rack or panel.

Bently Nevada Industrial Computer

The Orbit 60 Series Industrial Computer is certified for hazardous environments when installed in a NEMA3 or NEMA4 enclosure. The industrial computer communicates with an Orbit 60 Base SIM module to gather and output data to supported displays. The small form factor of 5.2 x 4.8 x 3.4 (132 x 122 x 87 mm) enables DIN-rail mounting.

Orbit Display Software

By default, a bar-graph screen shows all primary measurements. Use the Orbit Display software to create custom screens showing bar graphs, event lists, and statuses for machine-train groups from up to twelve systems on one display.

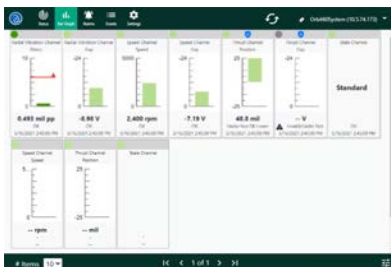

- System-event list
- Alarm-event list
- All module and channel data
- Alarm and OK status
- Nine custom display options

Orbit Studio Configuration Software

The Orbit Studio software configures Orbit 60 chassis, modules, channels, measurements, setpoints, relays, and many other aspects to protect plant assets.

Multiple Systems Configuration

Connect multiple systems from a single Orbit Studio client session, opening multiple offline configuration files alongside actively connected systems to allow for easy cross-referencing across systems, while enabling security through user-based permissions. Copy and paste modules and channels across systems and configuration files, as well as send and retrieve configurations for multiple systems at once.

Graphical System and Relay Configuration

Create and manage multiple pages of relay logic by graphically configuring with drag and drop elements and connectors. You can also graphically assemble your system by dragging and dropping components from a library of modules. The resulting assembly produces a hierarchical representation of the system for access to individual channels.

Current Values and Loop Check

View current value data across all channels within a system. You can use the bar graphs and tabular lists to complete loop checks from channels throughout the system.

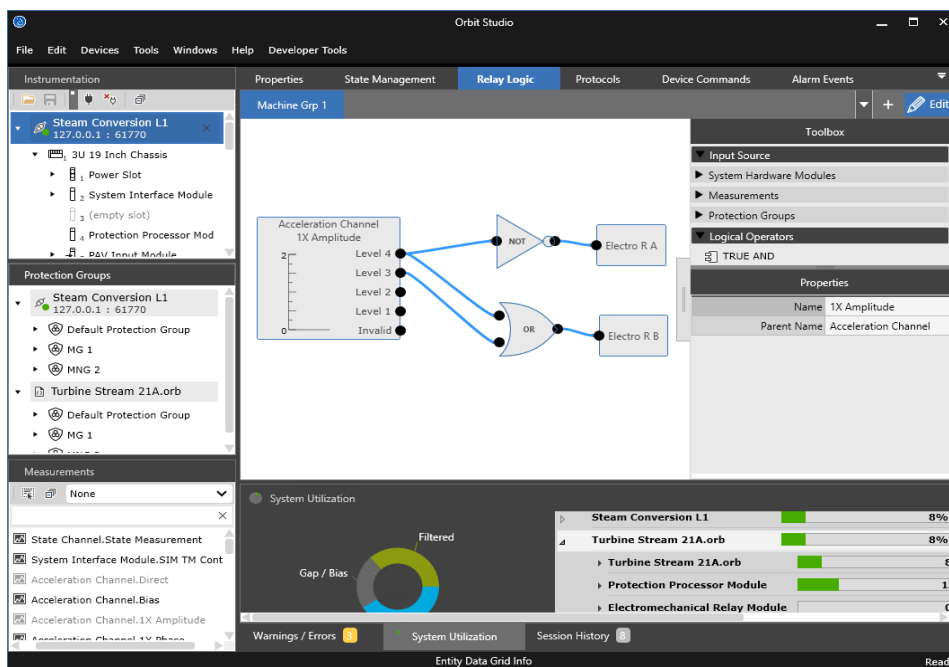

To configure the Orbit 60 system, refer to the Orbit Studio online help or Orbit Studio Configuration Software User Guide (137M0696).

System 1 Integration

Offering plant-wide condition monitoring insights to reduce risk, increase productivity, and minimize unplanned downtime, System 1 streamlines decision-making processes by bringing machine data into a single platform, providing clarity and context to your operations and enterprise. Harnessing the power of Bently Nevada's decades of machinery research and advanced diagnostics expertise, this powerful tool is a key component of successful digital transformation in any industrial facility. By combining its Connectivity, Analytics, and Visualization capabilities, System 1 is the premier Edge historian and condition monitoring platform among industrial operators.

Take full advantage of System 1 Condition Monitoring Software in conjunction with Orbit 60 Series for complete monitoring and advanced diagnostics for all machine types, including roller-element bearings. Use the Orbit 60 Series Condition Monitoring Module (CMM) for a read-only access point to provide a cyber-secure approach for obtaining data through the business network or other systems. When used in conjunction with the Comm Gateway module (CGW), you can relay high speed process data to System 1 along with system measured data.

System 1 brings it all together

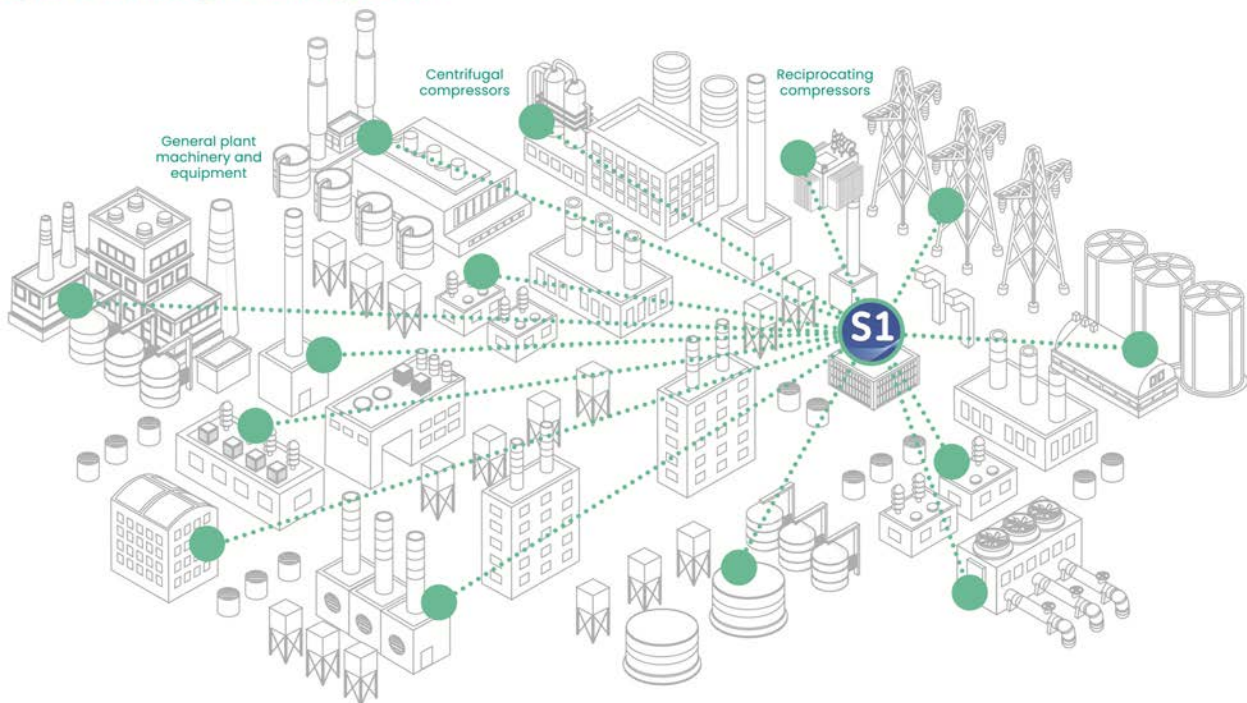

Bently Nevada has a rich heritage in helping customers solve industrial maintenance challenges that is over 60 years strong. Through user research in 25 countries with more than 500 end users, we have studied our customers' team dynamics, site processes, and technology suites to determine how System 1 can best support plant-wide machinery management. The resulting platform is the most comprehensive and user-intuitive condition monitoring solution ever developed.

Specifications

Orbit 60 System

3U 19" Full-Load Chassis

Power Consumption

Typical	120 watts
Maximum	180 watts



"The Orbit 60 Series system was qualified with the power supplies listed in accessory section of this datasheet. Use of a reduced wattage power supply may result in changed behavior under fault conditions."

Characteristics

Voltage Input	+21 to +32 Vdc
Current Draw	8.6 Amps max
Out of Range Protection	An undervoltage does not harm the PIM. An overvoltage causes the fuse to open.
Chassis Loading	No minimum chassis loading is required.

Weight

3U 19" Chassis	32 lbs (14.5 kg)
----------------	------------------

Physical Dimensions

Width	19" (48.26 cm) - with bezel 18.87" (47.93 cm) - panel mount without bezel 17.53" (44.53 cm) - rackmount without bezel
Height	5.2" (13.21 cm) - with bezel
Depth	9.67" (24.56 cm)

System Environmental

Operating Temperature Range (indoor use only)	-30° C to +65° C (-22° F to 149° F)
Storage Temperature Range	-40°C to +85°C (-40° F to 185° F)
Relative Humidity	0% to 95% rH non-condensing operating and storage
Vibration	5 g @ 57-500 Hz. IEC 60068-2-6
Shock	10 g, 11 ms IEC 60068-2-27
Altitude	< 2000 m (6,562 ft)
Pollution Degree	Pollution Degree 2
Installation Category	Category II



To determine the temperature rating of the cable connecting the field wiring terminals, identify the operating temperature range of the location where Orbit Display is installed.



CAUTION



ENVIRONMENTAL CONSIDERATIONS

For installations of temperatures above 40°C (104°F), active environmental control may be needed. For example, a dehumidifier or air-conditioning may be used to control formation of condensation.

System Interface Module

System Interface Module (SIM)	
System Contacts	
4 contacts on utility or rear side	Trip Multiply
	Alarm Inhibit
	System Reset
	Configuration Lock
Voltage In	24V max
Current rating	<1 mA to 125 mA
Protection Fault Relay (steady state)	
Voltage:	5 Vdc to 125 Vdc
Current	0.01 to 125mA
Communications	
1 ethernet port - public side	Independent Ethernet ports 1000/100/10 Base-T Auto-negotiation
2 ethernet ports - utility side	
Connector	RJ-45
Supported Connections	NTP time sources SF Protocol - System configuration SF Protocol - Local system display
Cable Length	100 meters (328 feet) max
Cyber Security	
<ul style="list-style-type: none"> Aligned to the IEC 62443 standard. Encrypted communications using latest TLS standards. PKI implemented signed firmware images to facilitate secure boot and trusted firmware updates. Device identity management uses certificates for trusted connections. 	

System Interface Module (SIM)
<ul style="list-style-type: none"> Configure user, roles and rights account management. Uses physical Run/Program control

System Interface Module (SIM)	
Controls and Contacts	
RST - Reset Contact or Button	Used to clear all latched alarms and NOT OK statuses across the system. LED indicates reset contact closed. ¹
SAI - System Alarm Inhibit Contact	Used to inhibit all alarms within the system. LED indicates the state of the alarming functions within the system.
TM - Trip Multiply Contact	Used to place the system in Trip Multiply. LED indicates that the system is in Trip Multiply mode.
LOCK - Configuration Lock Contact or Key	PRG - Allows configuration changes to be made to the system. Amber LED indicates the system is in Run mode. RUN - Locks the system, blocking configuration changes. Green LED indicates the system is in Run mode. ²
ARM - Protection Fault Relay	Indicates that all the protection functions within the system are operational.

¹ Performed by either closing the contact on the module or pressing the button on the front panel.

² Performed by either closing the contact on the module or setting the key on the front to the RUN setting on the front panel.

Protection Processor Module

Protection Processor Module (PPM)

Channel Types

- Radial Vibration
- Acceleration
- Velocity
- Thrust
- Speed
- Dynamic Pressure
- Temperature

Measurements and Signal Processing

Direct	Set based on the bandwidth of the selected transducer
Bandpass	Adjustable lowpass and highpass corners based on the frequency range of the transducer. Number of poles selectable from 1, 2, 4, 6 or 8.
1X/2X/nX Amplitude and Phase	Supported for machine speed ranges from 50 to 120,000 rpm.
Gap	Applicable to Proximitor sensor inputs
Bias	Applicable to Acceleration and Velocity sensor inputs
SMAX	Supported for ranges down to 50 rpm.
Speed	1 rpm to 120,000 rpm
Reverse Speed	Valid when the machine is spinning backwards. This measurement behaves like a typical speed measurement.
Reverse Peak Speed	Valid when the machine is spinning backwards and has exceeded the reverse speed setpoint, storing the highest achieved reverse

Protection Processor Module (PPM)

	speed.
Number of Reverse Rotation	Valid when the machine is spinning backwards and has exceeded the reverse speed setpoint, counting revolutions.
Rotor Acceleration	Rotor acceleration is a ramp rate of a rotor (in rpm / min) as its speed increases from zero rpm to the machine's running speed value.
Integration/RMS	Available for Velocity and Acceleration channels to be applied to Direct, Bandpass, 1X, 2X, nX an SMAX measurements.
Alarming	
Alarm Time Delays	100 ms to 60 sec for vibration and position measurements. 1 sec to 60 sec for speed measurements
Setpoints	Four setpoint levels available at a each measurement.
Protection States	Up to 32 Protection States that be controlled by Discrete contacts or configurable measurement ranges. Alarm setpoints are adjustable for different Protection States.

Communications Gateway

Communications Gateway (CGW)

Data Communications

2 ethernet ports - utility or rear side	Independent Ethernet ports 1000/100/10 Base-T Auto-negotiation
Connector	RJ-45
Cable Length	100 meters (328 feet) max

Condition Monitoring Module

Condition Monitoring Module (CMM)

Data Communications

2 ethernet ports - utility or rear side	Independent Ethernet ports 1000/100/10 Base-T Auto-negotiation
Connector	RJ-45
Cable Length	100 meters (328 feet) max

10.4" Hazardous Area Display

10.4" Hazardous Area Display

Part Number	120M8155-01
Warranty	1 Year
Features	
Video Interface	VGA
Touch Screen Type	Resistive Touch Screen
Cable Interface	Serial
Control Settings	Front panel button
Mounting Styles	Panel Mount, 19" EIA Rack Mount, and Independent Mount

10.4" Hazardous Area Display

Power Consumption

Voltage	24 Vdc nominal voltage range 10 to 28 Vdc
Operating Current	Less than 500 mA

Physical Characteristics

Dimensions	15.25 x 9.8 x 1.93 in 387.4 x 248.9 x 49 mm
------------	--

Environmental Limits - Indoor Use Only

IP Rating	Designed for IP54 ingress protection against dust and water spray to the front only.
Operating Temperature	0 to 60°C (32 to 140°F)

Standards and Certifications

Refer to External Display Datasheet (154M8401)

15" Hazardous Location Display

15" Hazardous Location Display

Part Number	102M8950
Warranty	1 Year
Features	
Video Interface	VGA
Touch Screen Type	5-Wire Resistive Touch Screen
Touch Screen Interface	Serial
Control Settings	Front panel button
Mounting Styles	Panel Mount and 19" EIA Rack Mount

Power

15" Hazardous Location Display	
Voltage	24 Vdc nominal voltage range 12 to 24 Vdc
Operating Current	~100 mA
Physical Characteristics	
Dimensions	16.61 x 13.31 x 2.68 in 422 x 338 x 68 mm
Environmental Limits - Indoor Use Only	
IP Rating	IP65 ingress protection against dust and water spray compliant to the front only.
Operating Temperature	-20 to 60°C (-4 to 140°F)
Standards and Certifications	
Refer to External Display Datasheet (154M8401)	

21.5" Industrial Display

21.5" Industrial Display	
Part Number	150M1466
Warranty	1 Year
Features	
Video Interface	VGA
Touch Screen Type	Projected Capacitive Touch Screen
Touch Screen Interface	USB
Control Settings	Control buttons on rear panel
Mounting Styles	Panel Mount and 19" EIA Rack Mount
Power	
Voltage	24 Vdc nominal voltage

21.5" Industrial Display	
	range 22 to 26 Vdc
Operating Current	≈ 200 mA
Physical Characteristics	
Dimensions	21.98 x 13.77 x 1.88 in 558.4 x 349.8 x 47.7 mm
Environmental Limits - Indoor Use Only	
IP Rating	IP66 ingress protection against dust and water spray compliant to the front only.
Operating Temperature	0 to 55°C (32 to 131°F)
Storage Temperature	-20 to 60°C (-4 to 140°F)
Ambient Relative Humidity	10 to 95% non-condensing
Standards and Certifications	
Refer to External Display Datasheet (154M8401)	

Display CPU Module

CPU Module	
CPU	Intel® Atom™ processor E3845 (quad-core, 1M cache, 1.91 GHz)
System Memory	4 GB
Storage	SD 3.0 (SDHC/SDXC) 128 GB
Display	Intel® HD Graphics 4000
Peripherals	
USB	2 – USB-A 2.0
VGA	Resolution up to 1920 x 1200 pixels at 75 Hz HDBB-15F port

CPU Module	
DisplayPort	Resolution up to 2560 x 1600 pixels at 60 Hz receptacle
Ethernet	4 – Auto-sensing 10/100/1000 Mbps RJ45 ports Magnetic Isolation Protection 1.5 kV
Serial	2 – RS-232/422/485 DB9M ports
Power	
Voltage	12/24 Vdc (11.4 to 36 Vdc)
Power	Less than 30 W (nominal)
Physical Characteristics	
Weight	1.75 kg (3.86 lbs.)
Dimensions	132 x 122 x 87 mm (5.20 x 4.81 x 3.43 in.)
Environmental Limits – Indoor Use Only	
Operating Temperature	-40 to 70°C (-40 to 158°F)
Standards and Certifications	
Refer to External Display Datasheet (154M8401)	

Dynamic Input Modules

Dynamic Input Modules	
PAV	(-) (Prox, Accel, Velom)
PAS	(-) (Prox, Accel, Seismic) *
PAA	(-) (Prox, Accel, Aero)
PAD	(-) (Prox, Accel, DC LVDT) *
PVT	(+) (Prox, Accel, Velom) *
Dynamic Inputs	
Analog Input	See Input Module Sensors and Measurements on page 14.

Dynamic Input Modules	
Channels Supported	4 Dynamic Inputs
Outputs	
Analog Buffered Transducer (BTO)	Short circuit protected output signal available through BTO connector on public and utility side.
BTO Connector	

* Not available for first release.

High Speed Keyphasor

High Speed Keyphasor Inputs (KPH)	
Inputs	
Analog Input	<ul style="list-style-type: none"> • Proximitor (3-wire) • Accelerometer (3-wire) • Proximitor Keyphasor (3-wire) • Magnetic Speed Pickups
Channels	4 Dynamic Inputs
Signal Conditioning	
Speed / Frequency Signal Ranges	Input range of 1 to 120,000 cpm (0.017 to 2 kHz).
Analog Buffered Transducer Output	Short-circuit protected output signal available through BTO connector on public and utility side.

 This is a true analog signal from the input, not digital-to-analog reconstitution of the input signal.

Isolated Process Variable / Discrete Input

Isolated PV / Discrete Input (PVD)	
Power Consumption	
Channels	6
Isolation	5700 V Channel to System and 250 V Channel to Channel isolation
Process Variable Input (Current)	4 to 20 mA 0 to 25 mA
Process Variable Input (Voltage)	-10 to 10 Vdc 0 to 10 Vdc 2 to 10 Vdc 0 to 5 Vdc 1 to 5 Vdc -10 to 0 Vdc

* The voltage drop across the input when configured for a current input is 100 Ohms x Input Current + 0.3 V.

Discrete Input	
Discrete Input	Dry Contact, Internally Wetted Wetted Contact, 0 to 10 Vdc

TC/RTD Temperature

Temperature	
Thermocouple (TC) Temperature	
Thermocouple	Type J, K, E, T
Channel Supported	6
RTD Temperature	
RTD Type	Pt100 (385), Pt100 (392), Ni120, Cu10

Isolated Thermocouple (ITC)

ITC Electrical	
Inputs	
Thermocouple Sensor	Type J, K, E, T
Electrical	
Isolation	500 V Channel to System and 250 V Channel to Channel isolation 700 V Channel-to-System and Channel-to-Channel isolation

Electromagnetic Relay (EMR)

Electromagnetic Relay (EMR)	
Characteristics	
Type	Electromechanical Single-Pole, Double-Throw
Number of Relay Outputs	8
Environmental	Epoxy Sealed
Operation	Each relay is configurable for Normally De-Energized or Normally Energized

Contact Rating for Standard Systems	
Minimum Switched Current	100 mA
DC Maximum Switched Current	4 A @ 30 Vdc
DC Maximum Switched Voltage	30 Vdc
AC Maximum Switched Voltage	250 Vrms
AC Maximum Switched Current	4 A
Maximum Switched Power	180 W or 1800 VA

Electromagnetic Relay (EMR)

Contact Rating for Hazardous Area Systems

Maximum Switched Current	4 A
DC Maximum Switched Voltage	30 Vdc
AC Maximum Switched Voltage	160 Vrms

Solid State Relay (SSR)

Solid State Relay (SSR)

Characteristics

Type	Solid State Single-Pole, Double-Throw
Number of Relay Outputs	8
Environmental	Plastic Encapsulated
Arc Suppressor	150 Vdc, installed standard
Contact Life	100,000 cycles @4.5 A, 30 VDC or 240 AC
Operation	Each relay is configurable for Normally De-Energized or Normally Energized

Contact Rating for Standard Systems

Minimum Switched Current	1 mA
DC Maximum Switched Current	125 mA @ 125 Vdc
DC Maximum Switched Voltage	125 Vdc
Maximum Switched Power	650 mW

Contact Rating for Hazardous Area Systems

Maximum Switched Current	125 mA
DC Maximum Switched Voltage	50 Vdc

Compliance and Certifications

FCC

This device complies with part 15 of the FCC Rules. Operation is subject to the following two conditions:

- This device may not cause harmful interference.
- This device must accept any interference received, including interference that may cause undesired operation.

EMC

European Community Directive:

EMC Directive 2014/30/EU

Standards:

EN 61000-6-2; Immunity for Industrial Environments
EN 61000-6-4; Emissions for Industrial Environments

Electrical Safety

European Community Directive:

LV Directive 2014/35/EU

Standards:

EN 61010-1;
EN 61010-2-201;

RoHS

European Community Directive:

RoHS Directive 2011/65/EU

Cyber Security

Designed to meet IEC 62443

Maritime*

ABS Rules for Condition of Classification, Part 1

- Steel Vessels Rules
- Offshore Units and Structures

Functional Safety*

SIL 2

* Approvals pending

Hazardous Area Approvals



For the detailed listing of country and product specific approvals, refer to the *Approvals Quick Reference Guide* (108M1756) available from Bently.com.

CSA/NRTL/C

Class I, Zone 2: AEx/Ex ec nC IIC T4 Gc;
Class I, Zone 2: AEx/Ex nA nC IIC T4 Gc;
Class I, Division 2, Groups A, B, C, D T4;
Class I, Division 2, Groups A, B, C, D T4 (N.I.);

T4 @ Ta= -30°C to +65°C (-22°F to +149°F)

ATEX/IECEx



Ex ec nC IIC T4 Gc
Ex nA nC IIC T4 Gc

T4 @ Ta= -30°C to +65°C (-22°F to +149°F)

Ordering Information



For the detailed listing of country and product specific approvals, refer to the *Approvals Quick Reference Guide* (108M1756) available from Bently.com.

Chassis

Chassis: 3U Rack

60R/CHA01	with options for: <ul style="list-style-type: none"> Country-specific codes SIL level
-----------	--

Chassis: 3U Panel

60R/CHA02	with options for: <ul style="list-style-type: none"> Country-specific codes SIL level
-----------	--

Chassis: 3U Bulkhead

60R/CHA03	with options for: <ul style="list-style-type: none"> Country-specific codes SIL level
-----------	--

System Modules

System Interface Module

60R/SIM01	with options for: <ul style="list-style-type: none"> Country-specific codes SIL level
-----------	--

Protection Processing Module

60R/PPM01	with options for: <ul style="list-style-type: none"> Country-specific codes SIL level
-----------	--

Power Input Modules

60R/PIM01	3 U Power Input Module with options for: <ul style="list-style-type: none"> Country-specific codes SIL level
-----------	--

Communications

Condition Monitoring Module

60R/CMM01	with options for: <ul style="list-style-type: none"> Country-specific codes
-----------	---

Communications Gateway

60R/CGW01	RJ-45 Ethernet	with options for: <ul style="list-style-type: none"> Country-specific codes SIL level
-----------	-------------------	--

Input Modules

Input: (PAV) Prox/Accel/Velom Module

60R/INP01	with options for: <ul style="list-style-type: none"> Country-specific codes SIL level
-----------	--

Input: (PAA) Prox/Accel/Aero Module

60R/INP02	with options for: <ul style="list-style-type: none"> Country-specific codes SIL level
-----------	--

Input: (KPH) Keyphasor Module

60R/INP06	with options for: <ul style="list-style-type: none"> Country-specific codes SIL level
-----------	--

Input: RTD / TC Module

60R/INP07	with options for: <ul style="list-style-type: none"> Country-specific codes SIL level
-----------	--

Input: (PVD) Isolated PV / DI Module

60R/INP09	with options for: <ul style="list-style-type: none"> Country-specific codes SIL level
-----------	--

Output Modules

Relay: (EMR) Electro-Mech Relay Module

60R/RLY01	with options for: <ul style="list-style-type: none"> • Country-specific codes • SIL level
-----------	---

Relay: (SSR) Solid State Relay Module

60R/RLY02	with options for: <ul style="list-style-type: none"> • Country-specific codes • SIL level
-----------	---

Power Supply Options *

60X/XPSAA-BBB

240W Power Supply for 3U chassis

60X/XPS01	with options for: <ul style="list-style-type: none"> • Country-specific codes
-----------	--

* Distance from PIM to Power Supply should not exceed 30 m (98 ft).

External Display

60X/EXDAA-BBB-CC

AA

01	10.4" Hazardous Area Display
02	15" Hazardous Area Display
04	21.5" Industrial Display

BBB – Hazardous Area Certifications

2- 3 digits	See Approvals Quick Reference Guide (108MI756) for more information.
-------------	--

CC

01	19" Rack Mount Panel
02	Panel Mount Kit
04	Independent Mount

* Displays include 10' power cable.

Bently Nevada Industrial Computer

60X/CMP-AAA

AAA	Hazardous Area Certifications
-----	-------------------------------

Includes DIN Mounting Kit, 24 Vdc 90-Watt DIN Mountable Power Supply, USB Mouse, 24 Vdc Power Cable, 10' (3m) Ethernet Cable. A 20' Ethernet cable accessory is available.

Front Panel Configurations

3U Front Panel: SIM w/ No Display

60R/PNL01	with options for: <ul style="list-style-type: none"> • Country-specific codes • SIL level
-----------	---

Dongles and Cables

60X/BTC01	4-Channel Buffered Output Adapter
-----------	-----------------------------------

External Barriers

175502	3-pin Transducer Barrier
177241	2-pin Velomitor Barrier

External Galvanic Isolators

103M7134	3-pin Transducer Isolator
103M7134	2-pin Transducer Isolator
154M1361	TC Type J, K, E, T Isolator
103M7138	RTD Isolator

Configuration Software

60X/CFG	Orbit Studio Configuration Software
---------	-------------------------------------

Miscellaneous

60R/BLK01	Blank: Module slot blank cover
-----------	--------------------------------

Glossary of Terms

Accel	Acceleration	PVD	Isolated Process Variable, Discrete Input
Aero	Aeroderivative	PVT	Positive Voltage Transducer
API	American Petroleum Institute	REB	Roller Element Bearing
BRG	Bridge	REC	Recorder Outputs
BTO	Buffered Transducer Output	RMC	Remote Monitoring Center
CGW	Communication Gateway Module	RST	Reset
CMM	Condition Monitoring Module	RTD	Resistance Temperature Detector
COM	Common	SAI	System Alarm Inhibit
DCS	Distributed Control Systems	SHLD	Shield
EGD	Ethernet Global Data protocol	SIL	Safety Integrity Level
ESD	Emergency Shutdown Device	SIM	System Interface Module
EIA	Energy Information Administration	SSR	Solid State Relay
EMR	electromechanical Relay	SW	Software
HAZLOC	Hazardous Location	TC	Thermocouple
HTVAS	High Temperature Velocity/Accel Sensor	TLS	Transport Layer Security
I/O	Input/Output	RTD/TC	Resistance Temp Detector / Thermocouple
IEPE	Integrated Electronics Piezo-Electric	TCP/IP	Transmission Control Protocol Internet Protocol
ITC	Isolated Thermocouple	TM	Trip Multiply
KPH	High Speed Keyphasor	OEM	Orginal Equipment Manufacturer
LVDT	Linear Variable Differential Transformer	Velom	Velomitor
NC	Normally Closed		
NEMA	National Electrical Manufacturers Association		
NO	Normally Opened		
NTP	Network Time Protocol		
OEM	Orginal Equipment Manufacturer		
PAA	Prox, Accel, Aero		
PAD	Prox, Accel, DC LVDT		
PAS	Prox, Accel, Seismic		
PAV	Prox, Accel, Velom		
PIM	Power Input Module		
PLC	Programmable Logic Controller		
PPM	Protection Processing Module		
Prox	Proximitor		

Copyright 2021 Baker Hughes Company. All rights reserved.



Bently Nevada, Orbit Logo, Keyphasor, Velomitor, Proximitor, and System 1 are registered trademarks of Bently Nevada, a Baker Hughes Business, in the United States and other countries. The Baker Hughes logo is a trademark of Baker Hughes Company. All other product and company names are trademarks of their respective holders. Use of the trademarks does not imply any affiliation with or endorsement by the respective holders.

Baker Hughes provides this information on an "as is" basis for general information purposes. Baker Hughes does not make any representation as to the accuracy or completeness of the information and makes no warranties of any kind, specific, implied or oral, to the fullest extent permissible by law, including those of merchantability and fitness for a particular purpose or use. Baker Hughes hereby disclaims any and all liability for any direct, indirect, consequential or special damages, claims for lost profits, or third party claims arising from the use of the information, whether a claim is asserted in contract, tort, or otherwise. Baker Hughes reserves the right to make changes in specifications and features shown herein, or discontinue the product described at any time without notice or obligation. Contact your Baker Hughes representative for the most current information.

The information contained in this document is the property of Baker Hughes and its affiliates; and is subject to change without prior notice. It is being supplied as a service to our customers and may not be altered or its content repackaged without the express written consent of Baker Hughes. This product or associated products may be covered by one or more patents. See [Bentley.com/legal](https://www.bentley.com/legal).

1631 Bently Parkway South, Minden, Nevada USA 89423
Phone: 1.775.782.3611 (US) or [Bentley.com/support](https://www.bentley.com/support)
[Bentley.com](https://www.bentley.com)