

## Current transducers - MCR-SL-S-200-I-LP - 2813499

Please be informed that the data shown in this PDF Document is generated from our Online Catalog. Please find the complete data in the user's documentation. Our General Terms of Use for Downloads are valid (<http://phoenixcontact.com/download>)

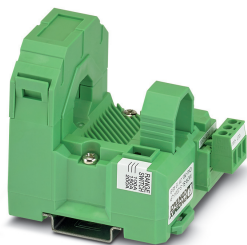

MCR current measuring transducer, for measuring sinusoidal and non-sinusoidal alternating currents, input current 0...200 A, loop-powered output with 4...20 mA

### Your advantages

- Can be retrofitted with open-up Rogowski coil
- Loop-powered
- 30 6000 Hz true r.m.s. value measurement
- Measuring range selection via slide switch



### Key Commercial Data

Packing unit	1 pc
GTIN	 4 046356 043670
GTIN	4046356043670
Weight per Piece (excluding packing)	144.500 g
Custom tariff number	85437040
Country of origin	Japan

### Technical data

#### Dimensions

Width	55 mm
Height	85 mm
Depth	70.5 mm
Primary round conductor (diameter)	18.5 mm

#### Ambient conditions

Ambient temperature (operation)	-20 °C ... 60 °C
Degree of protection	IP20

# Current transducers - MCR-SL-S-200-I-LP - 2813499

## Technical data

### Input data

Input	Current measuring input
Input current range	0 A ... 200 A (0 ... 100/150/200 A)
Operate threshold	1 % (of final value)
Setting range for min. input current	0 A ... 100 A
Setting range for max. input current	0 A ... 200 A
Overload capacity	Depending on laid conductor
Surge strength	Depending on through connected conductor
Frequency measuring range	30 Hz ... 6000 Hz

### Output data

Output name	Current output
Current output signal	4 mA ... 20 mA
Max. output current	< 25 mA
Load/output load current output	(U <sub>B</sub> - 12 V) x 350 / 12 A

### Switching output

Output name	No switching output
-------------	---------------------

### Power supply

Supply voltage range	12 V DC ... 24 V DC
----------------------	---------------------

### Connection data

Connection method	Pluggable screw connection
Stripping length	8 mm
Screw thread	M3
Conductor cross section solid	0.2 mm <sup>2</sup> ... 2.5 mm <sup>2</sup>
Conductor cross section flexible	0.2 mm <sup>2</sup> ... 2.5 mm <sup>2</sup>
Conductor cross section AWG	24 ... 14
Torque	0.5 Nm ... 0.6 Nm (4,4 ... 5,31 lbf-in.)

### General

Maximum transmission error	< 1 % (of final value)
Maximum temperature coefficient	< 0.025 %/K
Step response (10-90%)	< 340 ms
Overvoltage category	III
Degree of pollution	2
Rated insulation voltage	300 V AC (to earth)
Test voltage input/output	5 kV (50 Hz, 1 min.)
Color	green
Housing material	Polyamide PA non-reinforced
Mounting position	any

### Standards and Regulations

Conformance	CE-compliant
-------------	--------------

# Current transducers - MCR-SL-S-200-I-LP - 2813499

## Technical data

### Standards and Regulations

UL, USA/Canada	UL/C-UL listed UL 508
----------------	-----------------------

### Conformance/approvals

Designation	CE
Identification	CE-compliant
Designation	UL, USA/Canada
Identification	UL/C-UL Listed UL 508
	Class I, Div. 2, Groups A, B, C, D T4A
	Class I, Zone 2, Group IIC T4A
	Or Non-Hazardous Locations only

### Environmental Product Compliance

China RoHS	Environmentally Friendly Use Period = 25;
	For details about hazardous substances go to tab "Downloads", Category "Manufacturer's declaration"

## Drawings

Application drawing

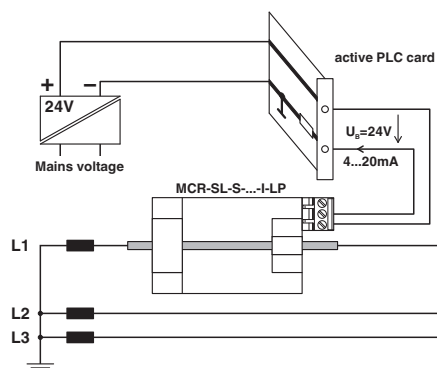

Dimensional drawing

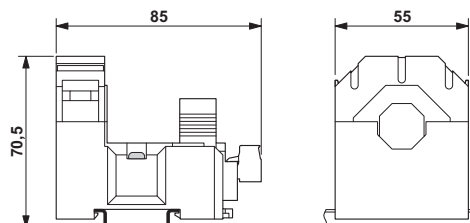

### Current monitoring

Circuit diagram

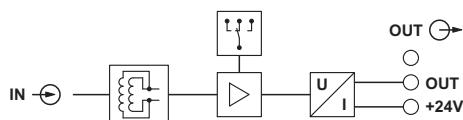

# Current transducers - MCR-SL-S-200-I-LP - 2813499

## Classifications

### eCl@ss

eCl@ss 10.0.1	27210123
eCl@ss 11.0	27210123
eCl@ss 4.0	27271100
eCl@ss 4.1	27200300
eCl@ss 5.0	27200300
eCl@ss 5.1	27200300
eCl@ss 6.0	27210100
eCl@ss 7.0	27210123
eCl@ss 8.0	27210123
eCl@ss 9.0	27210123

### ETIM

ETIM 3.0	EC002475
ETIM 4.0	EC002475
ETIM 5.0	EC002475
ETIM 6.0	EC002475
ETIM 7.0	EC002475

### UNSPSC

UNSPSC 6.01	30211506
UNSPSC 7.0901	39121008
UNSPSC 11	39121008
UNSPSC 12.01	39121008
UNSPSC 13.2	39121032
UNSPSC 18.0	39121032
UNSPSC 19.0	39121032
UNSPSC 20.0	39121032
UNSPSC 21.0	39121032

## Approvals

### Approvals

---

#### Approvals

UL Listed / cUL Listed / EAC / cULus Listed

---

#### Ex Approvals

---

### Approval details

## Current transducers - MCR-SL-S-200-I-LP - 2813499

### Approvals

UL Listed		<a href="http://database.ul.com/cgi-bin/XYV/template/LISEXT/1FRAME/index.htm">http://database.ul.com/cgi-bin/XYV/template/LISEXT/1FRAME/index.htm</a>	FILE E 123528
-----------	---	---	---------------

cUL Listed		<a href="http://database.ul.com/cgi-bin/XYV/template/LISEXT/1FRAME/index.htm">http://database.ul.com/cgi-bin/XYV/template/LISEXT/1FRAME/index.htm</a>	FILE E 123528
------------	---	---	---------------

EAC			RU*DE.*08.B.01852-19
-----	---	--	----------------------

cULus Listed			
--------------	---	--	--