

Ranger Pro Sensor Interface

Datasheet

Bently Nevada Machinery Condition Monitoring

165M4206 Rev. A



Description

The Ranger Pro Sensor Interface and external sensor combination is a smart wireless device that is engineered for quick installation and setup to monitor machine health and compliments existing Ranger Pro solutions (datasheet 125M5237). An applicable sensor is connected to the Ranger Pro Interface module by a short cable. Using industry standard wireless protocols such as ISA 100.11a and WirelessHART, the device complies with international, industrial wireless networking standards engineered to serve the needs of process industries.

The Ranger Pro Sensor Interface enables one applicable sensor to connect via cable to a single Ranger Pro interface module (two sensor connectivity will be available in a future release). This system measures overall velocity, acceleration, with spectrums/waveforms plus temperature ranging from low to high speed applications. Other measurement modalities are forthcoming.

The Bently Nevada Ranger Pro Sensor Interface enables you to:

- Monitor and optimize the reliability of low- and medium-criticality machines.
- Establish or expand existing reliability programs.
- Make maintenance decisions based on current data.
- Reduce maintenance costs.
- Decrease unplanned machine failures.
- Increase machinery life.
- Multi-channel support

Ranger Pro Sensor Interface is a simple, easy to implement solution for use in hazardous or difficult to access



environments such as elevated temperatures and tight or enclosed installations.

Use the Ranger Pro Sensor Interface to get short- and long-term trending data, and diagnostic reporting.

Quickly publish overall data through Modbus to third-party tools or spectra and waveform data through Generic Client or Hart IP Interface to Bently Nevada System 1 software. Configure Ranger Pro devices over-the-air using third-party tools or the Ranger Pro Configuration software.

Machinery Applications

Ranger Pro Sensor Interface is a vibration sensor for machines with roller-element bearings including:

- Agitators
- Air compressors
- Ball mills
- Blowers
- Centrifuges
- Cooling tower fans and pumps
- Motors
- Small reciprocating compressors
- Small hydro and steam turbines

Hardware Features

You can configure Ranger Pro Sensor Interface to work in a variety of environments and applications.

- Tri-axial capable velocity and acceleration detection.
- Machine surface temperature measurement.
- Mounting hardware options to fit most applications and integral alignment capability
- Replaceable lithium-chloride battery.
- IP67 dust and water resistant.
- Embedded sensors connect using the ISA100 wireless or WirelessHART network protocols.
- Can act as a router for other Ranger Pro sensors.

Wireless range varies depending on environmental obstacles, gateway antenna type, and the orientation of the sensor relative to the gateway antenna.

System 1 Support

Ranger Pro collects overall vibration, temperature measurements, timebase waveforms, spectra, and Peak Demod spectrum using Generic Client Interface (GCI) for ISA100 Ranger Pro devices and HART IP for WirelessHART Ranger Pro devices with System 1 software. You can filter overall and dynamic timebase and spectra data.

Network Installation

A typical network installation uses several Ranger Pro Sensor Interface sensors, Ranger Pro repeaters, wireless device managers, and access points. Ranger Pro Interface Module is available in either WirelessHART or ISA100 configuration.

You can use third-party tools or the Ranger Pro Configuration software to quickly provision and configure Ranger Pro devices over-the-air.

Compliance and Certifications

This device complies with part 15 of the FCC Rules. Operation is subject to the following two conditions:

1. This device may not cause harmful interference.
2. This device must accept any interference received, including interference that may cause undesired operation.

EMC conformity standards	IEC 61326-1, ETSI EN 301 489-1, CISPR22, ETSI EN 301 489-17
Radio spectrum	ETSI EN 300 328
Safety	ETSI EN 61010-1, IEC 62479
Hazardous Atmosphere	CSA Class I, Division1, Group A, B, C, D T4 Class II, Division1, Group F, G T135° ATEX/IECEX Zone 0
Conformity	Compliant with all CE and FCC/IC requirements
Valid for RangerPro BN P/N	147M7136-01-11 147M7136-02-11 160M0016-01

Hazardous Area Approvals

WARNING

HAZARDOUS ENVIRONMENT

Risk of explosive atmosphere.

Avoid electrostatic potential, especially on plastic components. Adapters, isolation valves, or sealing rings that are not compatible with process gasses will corrode and fail. This failure may result in gas leaks, fire, explosion, or projectiles.

De-energize all devices before placement or removal. To prevent corrosion and failure, verify that all components are compatible. Verify that hazardous materials, atmospheres, and conditions have been removed or that relevant risk mitigation measures have been implemented.

North America (US and Canada)	CSA Class I, Zone 0, AEx ia IIC T4 Ga Zone 20, AEx iaD IIIB T135°C Da Class I, Division1, Group A, B, C, D T4 Class II, Division1, Group F, G T135°
IECEX	Ex ia IIC T4 Ga Ex ia I Ma Ex ia IIIB T135°C Da
ATEX	II 1G Ex ia IIC T4 Ga I M1 Ex ia I Ma II 1D Ex ia IIIB T135°C Da

Specifications

Ranger Pro Tethered Accelerometer 70M503

Feature	Characteristic	Value
Axis	X, Y, Z	3
Sensing element		Micro-electromechanical sensors (MEMS)
Transverse sensitivity (Typical)	Transverse sensitivity (Typical)	< 7% (160 Hz)
Sensitivity tolerance		±5% (160 Hz)
Sensitivity	Z	39 mV/g
	X, Y	35 mV/g
Amplitude linearity		± 2%
Frequency response	Z (± 3 dB)	0.3 Hz to 10 kHz
	X, Y (± 3 dB)	0.3 Hz to 2.5 kHz
Resonant frequency	Z	> 15 kHz
	X, Y	5 kHz
Total noise (acceleration rms)	Z: 0.3 to 10 kHz	0.003 g
	X, Y: 0.3 to 2 kHz	0.004 g
Total noise (velocity rms)	Z: 1-200 Hz	0.18 mm/s [0.007 in/s]
	Z: 10-1000 Hz	0.09 mm/s [0.004 in/s]
	X,Y: 1-200 Hz	0.57 mm/s [0.022 in/s]
	X,Y: 10-1000 Hz	0.11 mm/s [0.004 in/s]
Temperature	Sensor type	Digital Resistance Temperature Device (RTD)
	Measurement range	-40°C to 125°C (-40°F to 257°F)
	Resolution	0.1°C (0.06°F)
	Accuracy	±1°C (typical), ±2°C (maximum)
	Measurement Interval	10 min, 20 min, 30 min, 1 h, 2 h, 3 h, 4 h, 6 h

Feature	Characteristic	Value
Electrical	Supply Current	2.09 mA (max)
	Output	Multiplexed output
	Grounding	Case isolated
	Connector	Top-exit, M12 A-coded, 5 pin
Mechanical	Material	316 Stainless
	Mounting	Integral M20x1.0 Coupling Nut
	Weight	62 g
	Sealing	Hermetic
Environmental	Operating temperature	-40°C to 125°C (-40°F to 257°F)
	IP Rating	IP66/67 when mated to connector
	Shock	5000 g
	Altitude	< 3000 m

Ranger Pro Sensor Interface: P/N 70M323 and 70M423

Trended Variables



Trend Variables apply when connected to a 70M503 Ranger Pro accelerometer.

Characteristic	Value
Temperature	
Measurement range	-40°C to 125°C (-40°F to 257°F)
Resolution	0.1°C (0.06°F)
Measurement Interval	10 min, 20 min, 30 min, 1 h, 2 h, 3 h, 4 h, 6 h
Acceleration	
Acceleration amplitude range	0 – 200 m/s ² (0 – 20 g)
Acceleration units / subunits	g or m/s ² / peak or rms
F _{min}	0.3, 2, 5, 10, 100, 200 (Hz)
F _{max}	200, 500, 1000, 2000, 5000, 10000±Hz ‡10,000 only on Z-axis
Measurement Interval	10 min, 20 min, 30 min, 1 h, 2 h, 3 h, 4 h, 6 h

Characteristic	Value
Velocity	
Velocity amplitude range	0 – 50 mm/s (0 – 2 in/s)
Velocity units / subunits	in/s or mm/s peak or rms
F _{min}	1, 5, 10 Hz
F _{max}	200, 500, 1000, 2000 Hz
Measurement Interval	10 min, 20 min, 30 min, 1 h, 2 h, 3 h, 4 h, 6 h
Peak Demod	
Peak Demod Pk	Z axis only Parameters based on PeakDemod Spectrum settings below
Measurement interval	6 h, 8 h, 12 h, 1 d, 2 d, 7 d, 14 d, 28 d

Waveforms and Spectra

Characteristic	Value
Acceleration	
Acceleration waveform	X, Y and Z axis
F _{min}	0.3, 2, 5, 10 Hz
F _{max}	200, 500, 1000, 2000, 5000, 10000 ‡ Hz ‡ Z-axis only
Number of samples	1024, 2048, 4096, 8192
Units/subunits	g or m/s ² / peak
Measurement Interval	6 h, 8 h, 12 h, 1 d, 2 d, 7 d, 14 d, 28 d
Velocity	
Velocity spectra	X, Y and Z axis depending on sensor model
F _{min}	5, 10
F _{max}	200, 500, 1000, 2000
Number of lines	400, 800, 1600, 3200
Units/subunits	in/s or mm/s / rms
Measurement Interval	6 h, 8 h, 12 h, 1 d, 2 d, 7 d, 14 d, 28 d

Characteristic	Value
Peak Demod	
Peak Demod spectrum	Z-Axis only
Fmax	200, 500, 1000, 2000, 5000 Hz
Demod Band Min	500, 1000, 2000, 5000 Hz
Units/subunits	g, m/s ² / peak
Measurement Interval	6 h, 8 h, 12 h, 1 d, 2 d, 7 d, 14 d, 28 d

Output Data

Characteristic	Value
Trended Variables	
ISA100 Temperature	Modbus: Supported GCI: Supported
wHART Temperature	Modbus: Supported HART-IP: Supported
ISA100 Acceleration	Modbus: Not supported GCI: Future Release
wHART Acceleration	Modbus: Supported HART-IP: Supported
ISA100 Velocity	Modbus: Supported GCI: Supported
wHART Velocity	Modbus: Supported HART-IP: Supported
ISA100 Peak Demod	Modbus: Not supported GCI: Future Release
wHART Peak Demod	Modbus: Supported (Channel 1 only) HART-IP: Supported

Waveforms and Spectra

Requires System 1 and either Generic Client Interface (GCI) or HART IP.

Wireless

Characteristic	Value
Network standard	ISA100.11a, WirelessHART
Network topology	Star (ISA100) or mesh (ISA100 or WirelessHART)
Radio standard	IEEE 802.15.4
Radio frequency	2.45 GHz ISM band
Provisioning/ firmware updates	Over-the-air or via the USB docking station.
Encryption/ security	128-bit AES encrypted packets
Output power	5.13 dBm, typical
Wireless range	150 meters sensor to access point, 100 meters sensor to sensor, line of sight. (Actual range depends on obstacles present, gateway antenna type, and orientation of the sensor relative to the gateway antenna.)

147M7136-01 ISA100 Device

Typical Conducted Power	8.7 dBm (7.4 mW)
Modulation	OQPSK, DSSS
Channel BW	5 MHz,
Operating Frequency	2.405 to 2.48 GHz

147M7136-02 WirelessHART Device

Typical Conducted Power	5.1 dBm (3.3 mW)
Modulation	OQPSK, DSSS
Channel BW	5 MHz
Operating Frequency	2.405 to 2.475 GHz

Battery and Power

Characteristic	Value						
Type	Replaceable D size 3.6V lithium-thionyl chloride with standard button-top termination. <div style="border: 1px solid black; padding: 5px; margin-top: 10px;">  Warning: Use only one of the following batteries: Tadiran TLH-5930, Tadiran TL-5930, Tadiran SL-2780, or Xeno Energy XL-205F. </div>						
Life	Up to five years depending on the operating mode and configuration.						
Hazardous area temperature range (Ta)	<table border="1" style="width: 100%; border-collapse: collapse;"> <thead> <tr> <th style="background-color: #008080; color: white;">Battery models</th> <th style="background-color: #008080; color: white;">Temperature range</th> </tr> </thead> <tbody> <tr> <td>TLH-5930</td> <td>-40°C < Ta < 80°C</td> </tr> <tr> <td>TL-5930, Xeno XL-205F, Tadiran SL-2780</td> <td>-40°C < Ta < 70°C</td> </tr> </tbody> </table>	Battery models	Temperature range	TLH-5930	-40°C < Ta < 80°C	TL-5930, Xeno XL-205F, Tadiran SL-2780	-40°C < Ta < 70°C
	Battery models	Temperature range					
TLH-5930	-40°C < Ta < 80°C						
TL-5930, Xeno XL-205F, Tadiran SL-2780	-40°C < Ta < 70°C						

Environmental Conditions

Characteristic	Value
Operating temperature	-40°C to 85°C (-40°F to 185°F) (Operating at extreme temperatures or beyond negatively affects battery life and may damage the device.)
Vibration limit	20 g peak
Chemical resistance	Stainless steel and high temperature, solvent- and UV-resistant PPS plastic.
Shock resistance	0.5 meter drop onto concrete
Altitude	Maximum 3,000 m (9,842 ft.) outdoors
IP rating	IP67 dust and water resistant

Physical/Mechanical

Characteristic	Value
Weight	400 grams with battery
Dimensions	Height: 100 mm; diameter: 40 mm
Case material	316 stainless steel body and glass-reinforced, impact-resistant PPS top
Mounting hole	M6 x 1 mm X 6.5 mm deep internal thread

Regulatory Compliance

Characteristic	Value
EMC conformity standards	IEC 61326-1, ETSI EN 301 489-1, CISPR22, ETSI EN 301 489-17
Radio spectrum	ETSI EN 300 328
Safety	ETSI EN 61010-1, IEC 62479
Hazardous Atmosphere	CSA Class 1 Division 1 Groups A, B, C, D T4 ATEX/IECEX Zone 0 Class II, Division1, Group F, G T135°
Conformity	Compliant with all CE and FCC/IC requirements
Valid for Ranger Pro BN P/N	70M323, 70M423, 70M503

Entity Parameters

Characteristic	Value
Ranger Pro Interface Modules	Lo: 800 μ H Co: 3.78 μ F Uo: 5.88V Io: 196 mA Po: 288 mW
Ranger Pro Triaxial Accelerometer	Lo: 0 μ H Co: 1.87 μ F Uo: 11.1V Io: 249 mA Po: 450 mW

ISA100.11a compatible gateways †

Characteristic	Value
Bently Nevada	Bently Nevada 70M320 ISA100.11a Gateway Up to 50 Ranger Pro devices per Gateway See the Ranger Pro Gateway Datasheet 157M8584
Yokogawa	YFGW 410 Field Wireless Management Station Up to 4 access points = 160 sensors
	YFGW 510 and YFGW 520 Field Wireless Access Points. Up to 40 Ranger Pro sensors per access point.

Characteristic	Value
Honeywell	WDM Wireless Device Manager R310.2-4 or newer Up to 8 access points = 320 sensors
	FDAP Field Device Access Point Up to 40 Ranger Pro sensors per access point
Ranger Pro sensor catalog number 70M323 is recommended for ISA100a Gateway Number of Hops (Depth to Gateway)	3

WirelessHART compatible gateways.†

Characteristic	Value
Emerson 1410S	1410S (compatible with firmware version 6.4.5 or newer) up to 200 Ranger Pro sensors per gateway
Emerson 1410A/B/D	1410 (compatible with firmware version 4.7.84 or newer) up to 70 Ranger Pro sensors per gateway
Emerson 1420	1420 (compatible with firmware version 4.7.84 or newer) up to 70 Ranger Pro sensors per gateway
Ranger Pro sensor catalog number 70M423 is recommended for WirelessHART Gateway Number of Hops (Depth to Gateway)	3

† Generic Client Interface (GCI) or HART IP required. Order when new or license as necessary.

Accelerometer to Interface Module Cable

Characteristic	Value
Mechanical	
Length	5 m, 10 m
Number of Conductors	5
Connector Type	M12 A-Code 5-Pin Plug and socket, straight
Connector Contact Pin	Gold Plated Copper Alloy

Characteristic	Value
Connector Housings	Stainless Steel
Cable Jacket	Black XLPE
Cable Shield	Braided ($\geq 90\%$ coverage), Tinned-Copper. Electrically terminated to Interface module connector only.
Cable Diameter	0.3 in, typical
Bend Radius	Diameter x 12
Electical	
Rated Voltage	300 Vdc
Environmental	
Operating Temperature	-40°C to 125°C
IP Rating	IP67 when mated
RoHS	Compliant
REACH	Compliant
UV Resistance	Yes
Flamability	FT2

System 1

v21.1 or higher. Refer to System 1 121M7997 release notes for compatibility guidelines.

Advanced Features

Characteristic	Value
Data on Demand	
Mode	User-initiated. Acquisition initiated from Ranger Pro Configuration Software.
Status	Idle, Requested or Busy
Data on Vibration	
Threshold	User settings. Range: 0 to 0.1 in/s rms
Mode	Enabled/Disabled
Detection	XYZ vector sum or Z axis only

Characteristic	Value
Status	On or Off
Data on Severity	
Mode	Enabled/Disabled
TA Proven Method Level 3	User settings. Range: 0.05 to 2.5 in/s rms
TA Proven Method Level 4	User settings. Range: 0.05 to 2.5 in/s rms
Detection	XYZ vector sum or Z axis only
Status	Green, Yellow or Red when enabled

Ordering Information



For the detailed listing of country and product specific approvals, refer to the *Approvals Quick Reference Guide* (108M1756) available from Bently.com.

Ranger Pro Accelerometer

70M503-AA-BB-CC-DD

A: Mounting Options

- 00 No Stud
- 01 M20x1.0 to 1/4-28
- 02 M20x1.0 to 3/8-24
- 03 M20x1.0 to 10-32
- 04 M20x1.0 to M6x1.0
- 05 M20x1.0 to M8x1.25
- 06 M20x1.0 to Cementing pad
- 07 M20x1.0 to 0.25x1.0 in Motor fin mount
- 08 M20x1.0 to 0.25x1.75 in Motor fin mount
- 09 M20x1.0 to 0.5x1.25 in Motor fin mount
- 10 M20x1.0 to 0.5x2.0 in Motor fin mount

B: Connector Type

- 01 Top Exit

C: Cable: Battery Option

- 00 No Cable
- 05 5 meter
- 10 10 meter

D: Approvals: Agency Approval Option

- 01 North America CII Div1
- 02 ATEX/IECEX

Ranger Pro Acceleration Interface

WirelessHART 70M423-AA-BB

ISA100 70M323-AA-BB



Ranger Pro versions 70M323, 70M423 use the same ordering information.

A: Battery Option

- | | |
|----|---------------------------------|
| 00 | No battery |
| 01 | Battery supplied, not installed |

B: Agency Approval Option

- | | |
|----|------------------------|
| 01 | North America CII Div1 |
| 02 | ATEX/IECEX |

Ranger Pro Installation Kit

130M5452 – AA

Description: Installation kit including battery installation tool, O-rings, wrenches, and USB readers.

A: Installation Package

- | | |
|----|-----------------------------------|
| 00 | Installation Tools |
| 01 | Installation Tools and USB Reader |
| 02 | USB Reader only |

System 1 Ranger Pro Device License

3071/13 – AA-BB-CC

Description: System 1 device license for Ranger Pro installed for use with System 1. One device license is required per interface module.

A: Not Applicable for Ranger Pro

00

B: Not Applicable for Ranger Pro

00

C: Ranger Pro Device

00 ## Number of licenses required



Option 3071/13 is only applicable to Ranger Pro devices that are installed for use with System 1. To order System 1, see **System 1 Software Package Datasheet** (document 108M5214). The AA option is only for vbOnline Pro device licenses. The BB option is only for 2300 monitor device licenses.

Spare Mounting Adapters

Illustrations shown are not to scale. All mounting adapters are made from 316 stainless steel.

Units are mm[in]

Part Number	Size	Illustration
Standard Studs		



Applies to all standard studs.

164M6491	M20x1.0 to 1/4-28 UNF	
164M6495	M20x1.0 to 3/8 - 24 UNF	

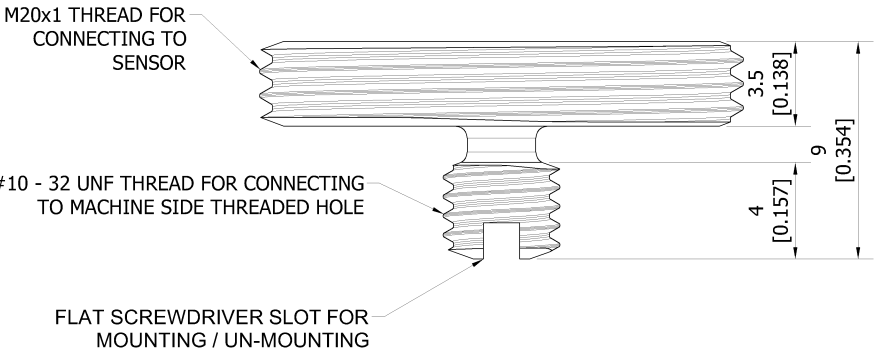
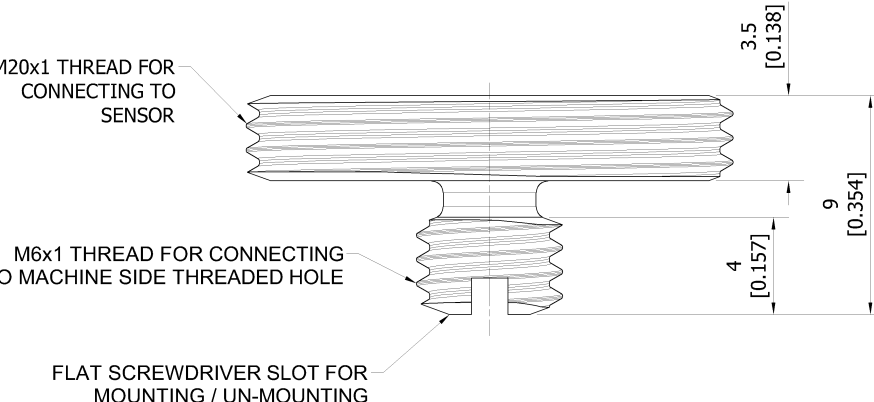
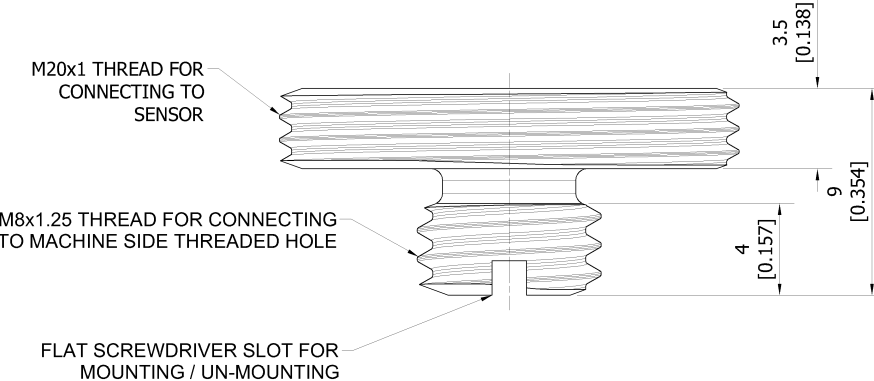
Part Number	Size	Illustration
164M6487	M20x1.0 to #10-32	 <p>M20x1 THREAD FOR CONNECTING TO SENSOR</p> <p>#10 - 32 UNF THREAD FOR CONNECTING TO MACHINE SIDE THREADED HOLE</p> <p>FLAT SCREWDRIVER SLOT FOR MOUNTING / UN-MOUNTING</p> <p>Dimensions: 3.5 [0.138], 4 [0.157], 9 [0.354]</p>
164M6489	M20x1.0 to M6x1.0	 <p>M20x1 THREAD FOR CONNECTING TO SENSOR</p> <p>M6x1 THREAD FOR CONNECTING TO MACHINE SIDE THREADED HOLE</p> <p>FLAT SCREWDRIVER SLOT FOR MOUNTING / UN-MOUNTING</p> <p>Dimensions: 3.5 [0.138], 4 [0.157], 9 [0.354]</p>
164M6493	M20x1.0 to M8x1.25	 <p>M20x1 THREAD FOR CONNECTING TO SENSOR</p> <p>M8x1.25 THREAD FOR CONNECTING TO MACHINE SIDE THREADED HOLE</p> <p>FLAT SCREWDRIVER SLOT FOR MOUNTING / UN-MOUNTING</p> <p>Dimensions: 3.5 [0.138], 4 [0.157], 9 [0.354]</p>

Part Number	Size	Illustration
-------------	------	--------------

Universal Magnetic Mounting Adapter

02200371	1.85" Ø x 1.09" H (47 x 27.7 mm), 100 lbf (45kg) pull, 2-pole, ¼-28 female UNF thread. Requires mounting option -01.	
----------	--	--

Cementing Pads and Adhesive

164M6490	M20x1.0 to epoxy cementing pad	
----------	--------------------------------	--

167236-01	3.5 g Click Bond CB200 acrylic adhesive for use with epoxy cementing pads. Sufficient for about four pads.	
-----------	--	--

Motor Fin Adhesive Mounts

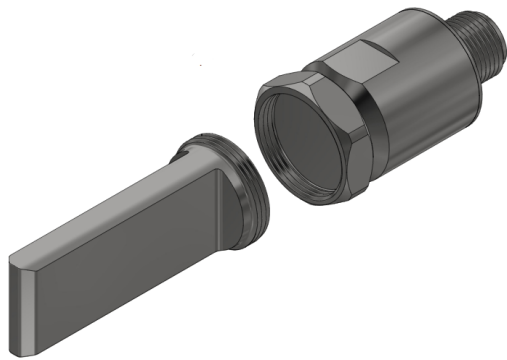

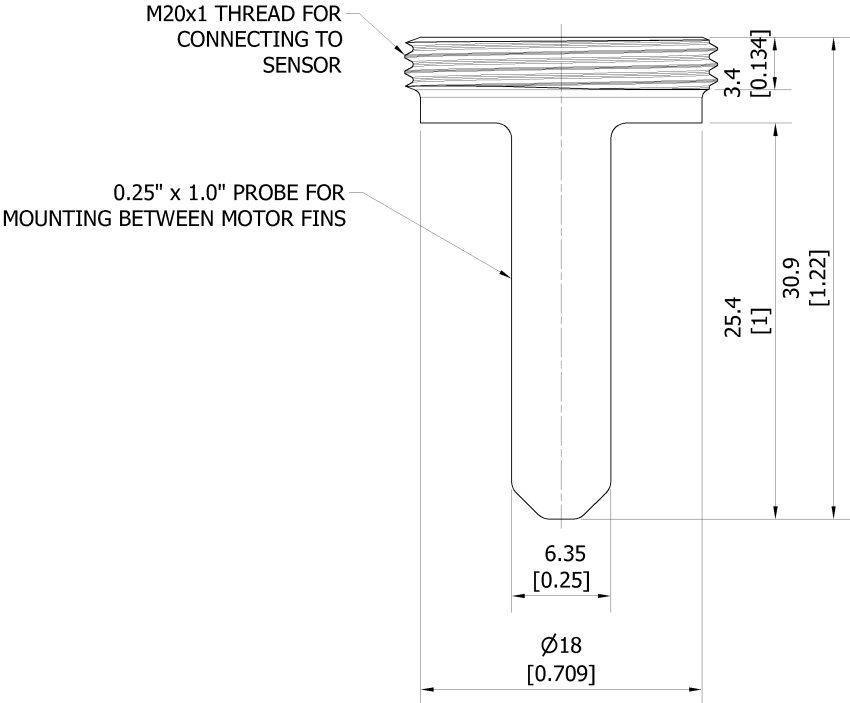
Part Number	Size	Illustration
164M6492	M20x1.0 to 0.25" x 1.0"	 <p>M20x1 THREAD FOR CONNECTING TO SENSOR</p> <p>0.25" x 1.0" PROBE FOR MOUNTING BETWEEN MOTOR FINS</p> <p>3.4 [0.134]</p> <p>25.4 [1]</p> <p>30.9 [1.22]</p> <p>6.35 [0.25]</p> <p>∅18 [0.709]</p>

Part Number	Size	Illustration
164M6486	M20x1.0 to 0.25" x 1.75"	<p>M20x1 THREAD FOR CONNECTING TO SENSOR</p> <p>0.25" x 1.75" PROBE FOR MOUNTING BETWEEN MOTOR FINS</p> <p>3.4 [0.134]</p> <p>44.45 [1.75]</p> <p>49.95 [1.97]</p> <p>6.35 [0.25]</p> <p>Ø18 [0.709]</p>

Part Number	Size	Illustration
164M6488	M20x1.0 to 0.5" x 1.25"	<p>M20x1 THREAD FOR CONNECTING TO SENSOR</p> <p>0.5" x 1.25" PROBE FOR MOUNTING BETWEEN MOTOR FINS</p> <p>3.4 [0.134]</p> <p>31.75 [1.25 in]</p> <p>37.25 [1.467]</p> <p>12.7 [0.5 in]</p> <p>Ø18 [0.709]</p>

Part Number	Size	Illustration
164M6485	M20x1.0 to 0.5" x 2.00"	<p>M20x1 THREAD FOR CONNECTING TO SENSOR</p> <p>0.5" x 2.0" PROBE FOR MOUNTING BETWEEN MOTOR FINS</p> <p>3.4 [0.134]</p> <p>50.8 [2]</p> <p>56.3 [2.22]</p> <p>12.7 [0.5]</p> <p>∅18 [0.709]</p>









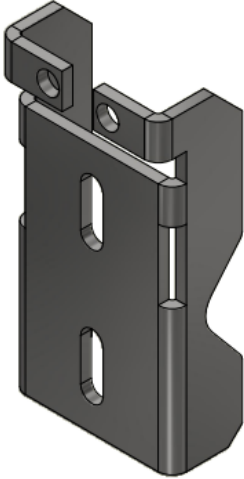
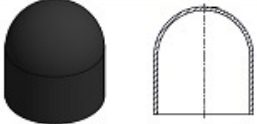
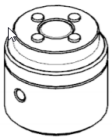





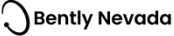



Expect a decrease in X, Y, Z accuracy when using fin type mounts.

Accessories

The installation kit (121M7992) includes a battery installation tool, two installation wrenches, spare O-rings, and USB docking station. These parts can also be ordered individually.

Product or Document	Item	
164M6494	Ranger Pro Interface Module Mounting Bracket and fasteners	
159M7787	Ranger Pro Cap: additional protection for high moisture installations	
121M7993	Battery installation tool	
160M0017	5 meter cable	
160M0018	10 meter cable	
129M0166	Sony USB configuration docking station	
146M4035	Case O-ring 35 x 1 mm (qty. 20)	
146M4036	E-module O-ring 34 x 1 mm (qty. 20)	
125M3923	D-sized lithium-thionyl chloride 3.6 V battery	
121M7997	Ranger Pro Sensor Interface configuration software (not available for order, it is available for no charge from Bently Nevada Technical Support)	
125M6113	Ranger Pro Sensor Interface User Guide	

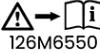
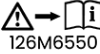
Catalog Order Number (1)	Part Number	Figure
70M323-XX-XX	147M7136-01-11	<p>S/N: ADYYM###</p> <p> CSA18CA70178198 P/N: 147M7136-01-11 CI I Div 1 Gr ABCD T4 c_{us} CI II Div 1 Gr FG T135°C CI I Zn 0 AEx ia IIC T4 Ga Zn 20 AEx iaD IIIB T135°C Da</p> <p> II 1G Ex ia IIC T4 Ga Uo: 5.88V Io: 196mA  I M1 Ex ia I Ma Po: 288mW  II 1D Ex ia IIIB T135°C Da Lo: 800uH Co: 3.78µF Sira 18ATEX2151X -40°C ≤ Ta ≤ +100°C 0598 IECEx CSA 18.0021X</p> <p>FCC ID XFU-147M71B IC: 8349A-147M71B</p> <p>ISA100 </p> <p>RANGER PRO  1631 Bently Parkway South Minden, NV 89423 USA AIM 70M323 Made in South Africa</p>
70M423-XX-XX	147M7136-02-11	<p>S/N: ADYYM###</p> <p> CSA18CA70178198 P/N: 147M7136-02-11 CI I Div 1 Gr ABCD T4 c_{us} CI II Div 1 Gr FG T135°C CI I Zn 0 AEx ia IIC T4 Ga Zn 20 AEx iaD IIIB T135°C Da</p> <p> II 1G Ex ia IIC T4 Ga Uo: 5.88V Io: 196mA  I M1 Ex ia I Ma Po: 288mW  II 1D Ex ia IIIB T135°C Da Lo: 800uH Co: 3.78µF Sira 18ATEX2151X -40°C ≤ Ta ≤ +100°C 0598 IECEx CSA 18.0021X</p> <p>FCC ID XFU-147M71A IC: 8349A-147M71A</p> <p>RANGER PRO  1631 Bently Parkway South Minden, NV 89423 USA AIM 70M423 Made in South Africa</p>
70M503-XX-XX-XX-XX	160M0016-01	<p>S/N: ADYYMG##</p> <p> RANGER PRO Bently Nevada Triaxial Accelerometer P/N: 160M0016-01 1631 Bently Parkway South Minden, NV 89423 USA Made in South Africa</p> <p>  CSA18CA70178198 CI I Div 1 Gr ABCD T4 c_{us} CI II Div 1 Gr FG T135°C CI I Zn 0 AEx ia IIC T4 Ga Zn 20 AEx iaD IIIB T135°C Da</p> <p> II 1G Ex ia IIC T4 Ga  I M1 Ex ia I Ma  II 1D Ex ia IIIB T135°C Da Sira 18ATEX2151X 0598 IECEx CSA 18.0021X Ui: 11.1V Ii: 249mA Pi: 550 mW Li: 0H Ci: 1.87µF -40°C ≤ Ta ≤ +100°C</p> <p>  126M6550</p>

Drawings and Figures

Dimensions are given in mm [inches] unless noted otherwise.

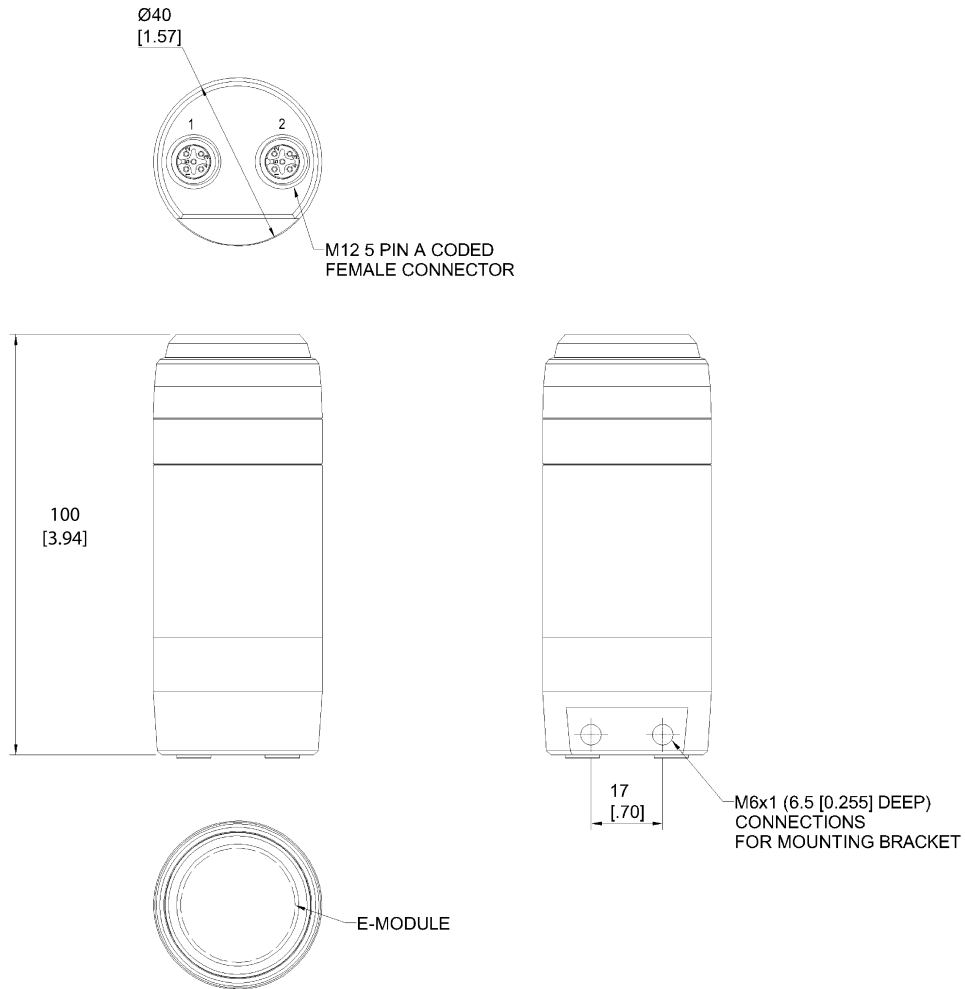

Figure 1: 70M323 and 70M423 Ranger Pro Sensor Interface Modules

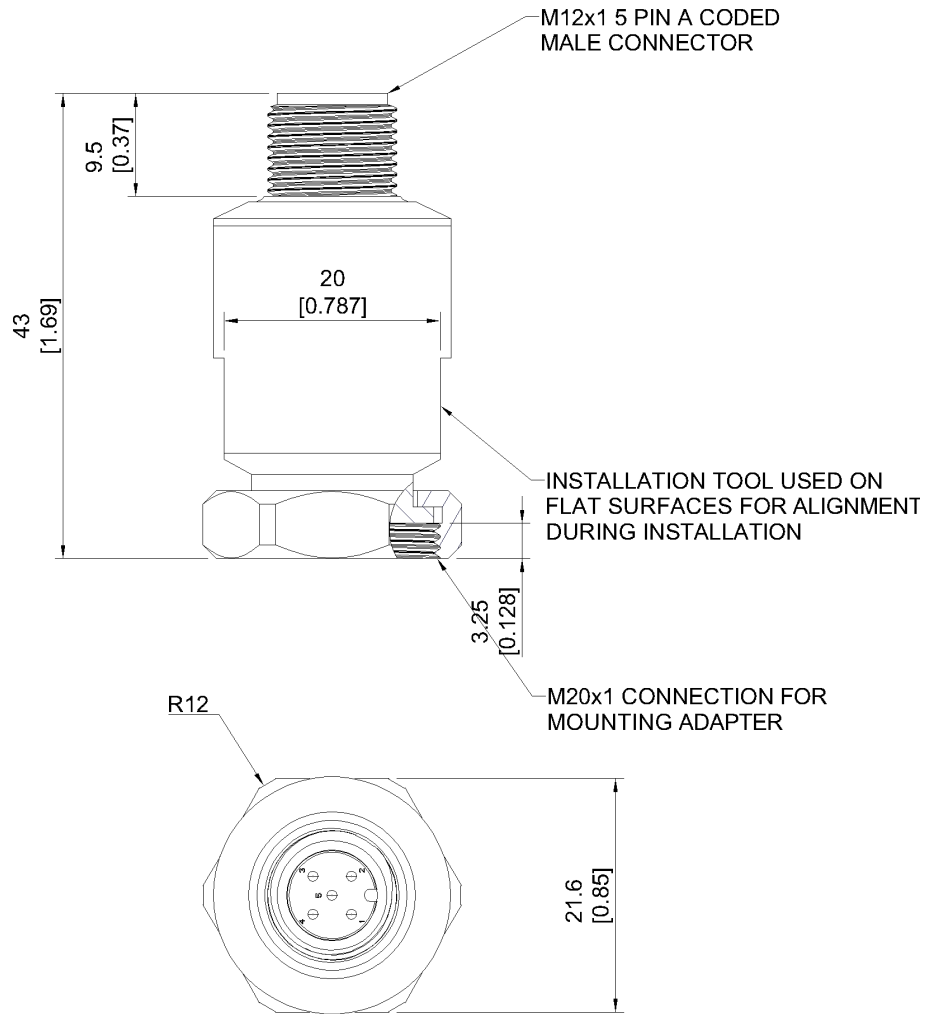

Figure 2: Ranger Pro 70M503 Accelerometer Top Exit

Copyright 2022 Baker Hughes Company. All rights reserved.



Bently Nevada, M2, Ranger, System 1, vbOnline and Orbit Logo are registered trademarks of Bently Nevada, a Baker Hughes business, in the United States and other countries. The Baker Hughes logo is a trademark of Baker Hughes Company. All other product and company names are trademarks of their respective holders. Use of the trademarks does not imply any affiliation with or endorsement by the respective holders.

Baker Hughes provides this information on an "as is" basis for general information purposes. Baker Hughes does not make any representation as to the accuracy or completeness of the information and makes no warranties of any kind, specific, implied or oral, to the fullest extent permissible by law, including those of merchantability and fitness for a particular purpose or use. Baker Hughes hereby disclaims any and all liability for any direct, indirect, consequential or special damages, claims for lost profits, or third party claims arising from the use of the information, whether a claim is asserted in contract, tort, or otherwise. Baker Hughes reserves the right to make changes in specifications and features shown herein, or discontinue the product described at any time without notice or obligation. Contact your Baker Hughes representative for the most current information.

The information contained in this document is the property of Baker Hughes and its affiliates; and is subject to change without prior notice. It is being supplied as a service to our customers and may not be altered or its content repackaged without the express written consent of Baker Hughes. This product or associated products may be covered by one or more patents. See [Bentley.com/legal](https://www.bentley.com/legal).

1631 Bently Parkway South, Minden, Nevada USA 89423
Phone: 1.775.782.3611 (US) or [Bentley.com/support](https://www.bentley.com/support)
[Bentley.com](https://www.bentley.com)