

POWER DISTRIBUTION

RiLine busbar systems

Overview	251
RiLine Compact busbar system	256
Mini-PLS busbar system (40 mm)	260
RiLine busbar systems (60 mm)	266
RiLine fuse elements	289
RiLine accessories	306

Ri4Power

Overview, Ri4Power system 185 mm	324
Ri4Power system 185 mm	330

Overview, Ri4Power	351
Modular enclosures	89
Installation accessories for modular front design	662
Isolator enclosures	91
Busbar enclosures	92
Busbar systems (100/185/150 mm)	352
Maxi-PLS busbar systems	354
Flat-PLS busbar systems	357
Connection components for Maxi-PLS/Flat-PLS	360
Cover systems	365
Compartment configuration Form 1-4	367
Ri4Power accessories	374

Overview, ISV	379
Distribution enclosures, based on TS 8	88
Distribution enclosures, based on SE 8	94
Distribution enclosures, based on AE	58
Mounting kits	380
Installation modules	381
Accessories, ISV	386



Power distribution

Rittal – The System.

Faster – better – everywhere.



RiLine busbar systems				
<p>The tried-and-trusted, super-flexible power distribution systems for individual requirements. From small power distributors, to individual switchgear and controlgear, through to heavy-current power distributors for infrastructure and industry applications. Simple, secure assembly plus user-friendly planning with design verification are the distinguishing features of these systems.</p>				
Busbar system	RiLine Compact	Mini-PLS	RiLine PLS/flat copper bars	
Bar centre distance mm	–	40	60	
Rated current A up to	125	250	800, 1600	
Product characteristics	<ul style="list-style-type: none"> ■ Contact hazard-protected board with integral busbars for the safe accommodation and contacting of components ■ The board and all components are simply top-mounted; no tools required ■ Suitable for AC and DC applications 	<ul style="list-style-type: none"> ■ Space-saving design with full-surface top-mounting of the busbar supports and bar connector elements ■ Simple component installation via plug and lock action from the front ■ Optimum contact hazard protection with all-round encapsulation 	<ul style="list-style-type: none"> ■ Thanks to the special styling of the PLS special busbars, top-mounting with components in the support area is not a problem ■ Optimum contact hazard protection with all-round encapsulation ■ Suitable for AC and DC applications 	
From page	256	260	265	

Power distribution



Ri4Power

<p>The tested complete solution – Enclosure and bar system. Cross coupling between electrical equipment in low-voltage switchgear has already been tested to IEC 61 439 and documented with a design verification.</p>	<p>Modular system for low-voltage switchgear with design verification to IEC 61 439-1/-2 and DIN EN 61 439-1/-2, plus power distributors and structured system solutions for switchgear with 1-4b Form separation.</p>	<p>ISV distribution enclosures for standard-compliant power supply in buildings and industry. Flexible configuration with practical power distribution modules.</p>
<p>185 mm system</p>	<p>Flat copper bars, Maxi-PLS, Flat-PLS</p>	<p>–</p>
<p>185</p>	<p>100, 150, 185</p>	<p>–</p>
<p>2100</p>	<p>5500</p>	<p>–</p>
<ul style="list-style-type: none"> ■ Supports top-mounting of the busbar support with components on the cover system pitch pattern ■ Integral busbar shielding in the cover section to prevent accidental arcing ■ Top-mounting of the cover section and quick retrofitting of components without removing the cover section 	<ul style="list-style-type: none"> ■ Tested system solutions to the internationally valid standard IEC 61 439-1 and simple creation of the design verification ■ High levels of short-circuit withstand strength up to I_{cw} 100 kA for 1 sec./I_{pk} 220 kA ■ Tested accidental arcing protection to IEC 61 641 	<ul style="list-style-type: none"> ■ Distribution enclosures as wall-mounted and free-standing enclosures for individual population with modular elements
<p>330</p>	<p>351</p>	<p>379</p>

Rittal – The System.

Faster – better – everywhere.



Busbar systems

RiLine Compact busbar system

Board	256
Busbar connection adaptor	257
Component adaptor	257
Motor controllers	258
Electronic power switches	258
Accessories	259

Mini-PLS busbar system (40 mm)

Busbar supports	260
Special busbars E-Cu	260
Contact hazard protection	260
Busbar connection adaptor	260
Bus-mounting fuse base	261
NH fuse-switch disconnectors, size 000	261
Component adaptors up to 25 A	262
Component adaptors up to 100 A	263
Switchgear assignment	263

RiLine busbar system (60 mm)

Flat copper bar system	266
PLS busbar system	268
Busbar connection adaptor	270
Busbar connection adaptor, extra set	272
OM adaptor up to 65 A, with connection cables	273
OM adaptor up to 65 A, with tension spring clamps	276
OM adaptor up to 25 A, with plug-in cable outlet	278
OM support	279
Circuit-breaker component adaptor up to 630 A, 3-pole	280
Circuit-breaker component adaptor up to 500 A, 4-pole	284
Switchgear assignment	285
Bus-mounting fuse bases	289
NH fuse-switch disconnectors, size 000	291
NH fuse-switch disconnectors, size 00 to 3	293
– With electronic fuse monitoring	295
– With electromechanical fuse monitoring	297
Smart Monitoring System.	
– NH measurement module	299
– Display/power pack	300
NH slimline fuse-switch disconnectors, size 00	301
– With electronic fuse monitoring	302
Fuse holder 30 A to 400 A	303
RiLine accessories	306



RiLine Compact – Power distribution in a confined space

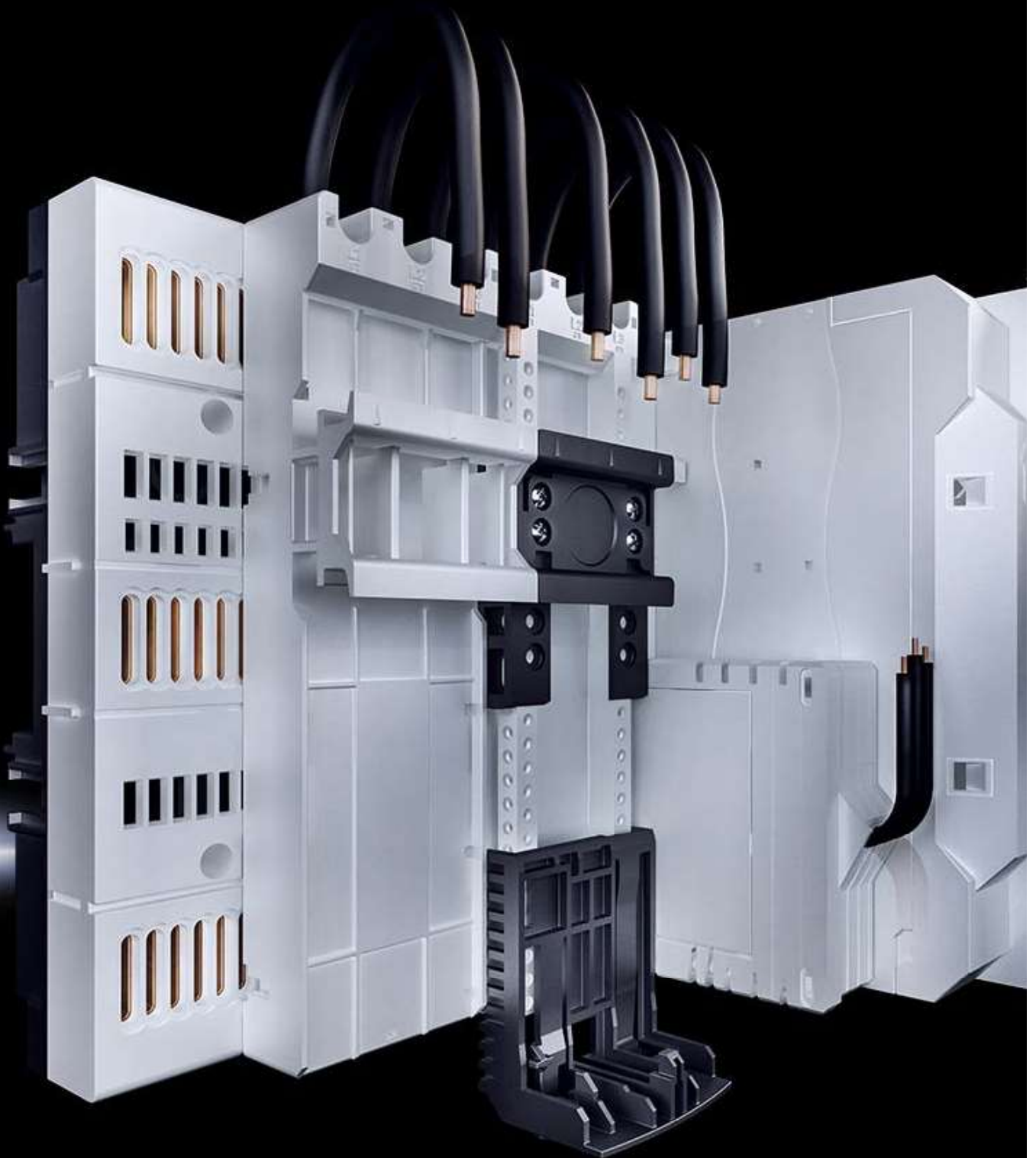

Tested system solution for power distribution

- Compact layout for controlgear up to 125 A
- Fast, space-saving assembly compared with conventional wiring technology
- All-round shock-hazard-protected busbar system
- Standardised, standard-compliant assembly of a wide range of component types
- Compliant with standards IEC 61 439 and UL 508

Compact, safe installation

- Tool-free attachment of components with plug-in mounting; electrical contact is made automatically
- Special latching ensures secure attachment of components. When dismantling, the latch can only be released with a screwdriver.
- Requires less space than conventionally wired motor controlgear

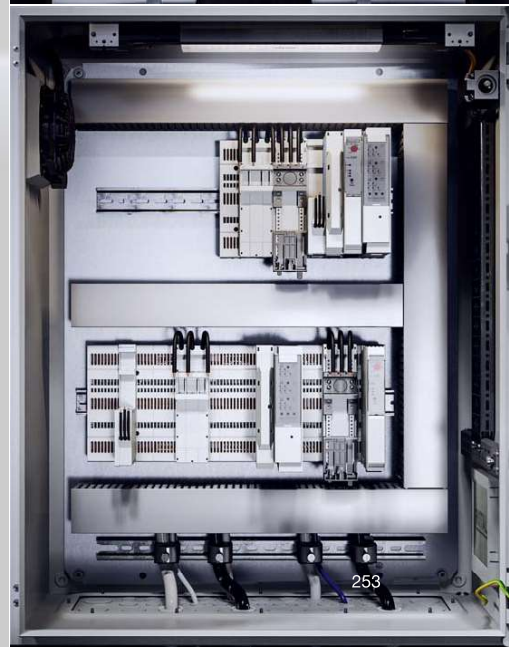
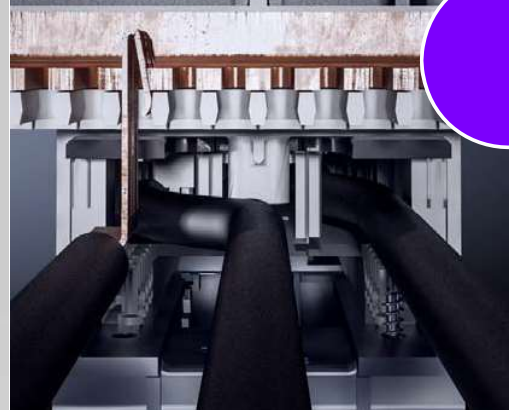
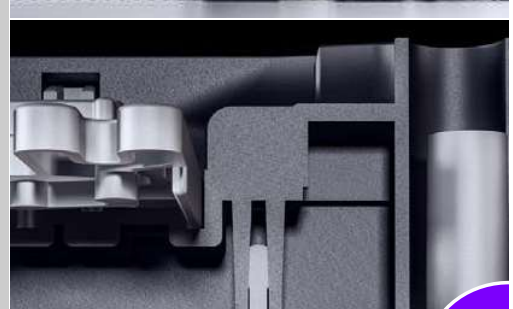
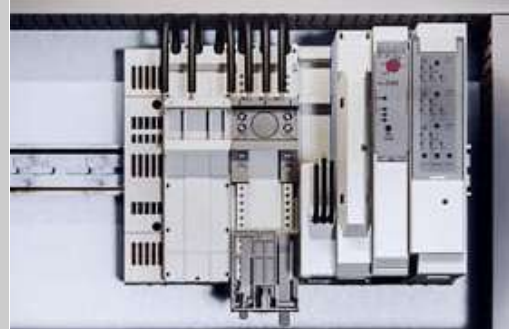

RiLine Compact – Simple, tool-free installation



Tool-free installation made easy

- RiLine Compact Board in 225 and 405 mm width
- Simply latches onto a 35 x 7.5 mm and 35 x 15 mm support rail
- Components are quickly top mounted without the need for tools
- Pre-punched pitch units of 45 mm in the board allow secure, fast positioning of components on the seamless 4.5 mm contact pitch pattern



Safe adaptor connection

- Screw-free connection with maintenance-free tension spring technology in the bus-bar connection adaptor
- Component adaptors meet the particular requirements of IEC 61 439 for laying active conductors
- Component adaptors with integral fuse holders on a 22.5 mm build width, for space-saving assembly
- Component adaptors optionally with fixed or adjustable support rail for the secure assembly of switchgear and protective gear

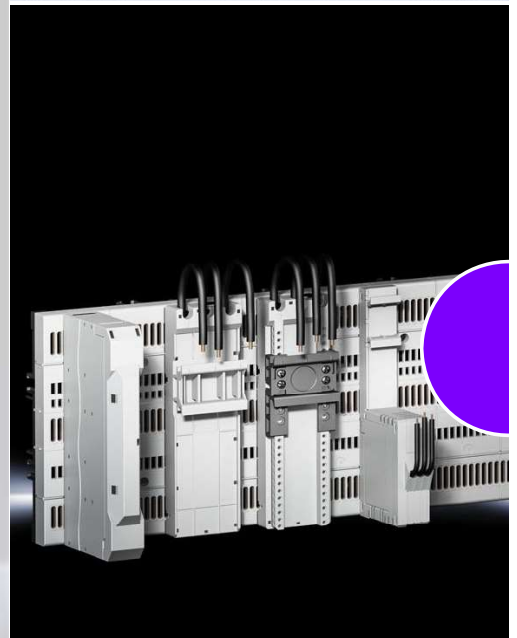

Space-saving installation of function modules

- Motor controller for motor starters and reversing starters up to 4 kW with electronic overload protection
- Electronic power switch for clocked heating output control
- Hybrid technology for higher switching frequency and minimal heat loss
- Long service life



RiLine Compact

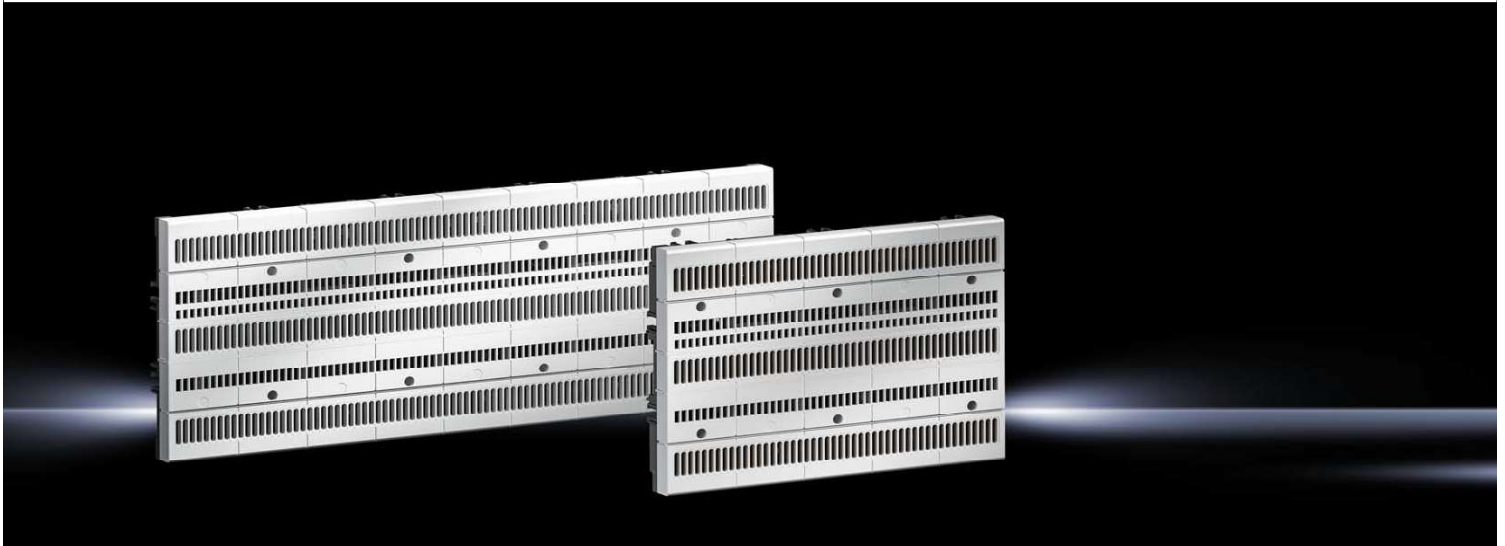

Busbar connection adaptor/component adaptor Page 257 **Motor controller/electronic power switch** Page 258

Function:

- Shock-hazard-protected busbar board for the safe accommodation and contacting of components with plug-in mounting
- For snap-on mounting onto 35 x 7.5/15 mm busbars or for direct attachment to the mounting plate

Material:

- Polyamide
- Polycarbonate
- E-Cu
- Fire protection corresponding to UL 94-V0

Approvals:

- UL listed

Standards:

- UL 508
- EN 61 439

Note:

- The technical data given here may vary for UL applications.

Colour:

- RAL 7035

Protection category to IEC 60 529:

- IP 20

Supply includes:

- Integral busbars

Board

Width mm	P. of	225	405
Height mm		160	160
Depth mm		45.1	45.1
Rated max. current A		125	125
Rated operating voltage V		690 (AC), 600 (DC)	690 (AC), 600 (DC)
Number of poles		3-pole	3-pole
No. of space units @ 45 mm		5	9
Model No.	1 pc(s).	9635.000	9635.010

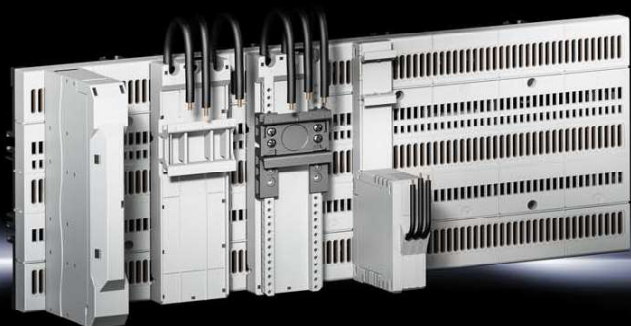

Board Page 256 **Motor controller/electronic power switch** Page 258 **Accessories** Page 259

Function of busbar connection adaptor:

- Direct connection of conductors using spring terminals

Function of component adaptor:

- For assembly of switchgear and protective gear with support rail attachment

Material:

- Polyamide
- Fire protection corresponding to UL 94-V0

Colour:

- RAL 7035

Approvals:

- UL

Note:

- The technical data given here may vary for UL applications.

Busbar connection adaptors/component adaptors

Version	Busbar connection adaptor	Component adaptor	Component adaptor, Basic	
Rated max. current A	80	16	16	32
Rated operating voltage V	690 (AC), 600 (DC)	690 (AC), 600 (DC)	690 (AC), 600 (DC)	690 (AC), 600 (DC)
Number of poles	3-pole	3-pole	3-pole	3-pole
Cable outlet	Top/bottom	–	–	–
Connection of round conductors	AWG 6 – 16	–	–	–
Connection of round conductors, fine wire with/without wire end ferrule mm ²	1.5 – 16	–	–	–
Connection of round conductors, single-wire mm ²	1.5 – 10	–	–	–
Connection of round conductors, multi-wire mm ²	16	–	–	–
Connection cables, version	–	AWG 14	AWG 14	AWG 10
Connection cables, length mm	–	125	120	100
Conditional rated short-circuit current I _{cc} kA	–	50	–	–
For fuse	–	10 x 38 mm/Class CC (max. 16 A)	–	–
No. of fixed support rails/height mm	–	1/10	1/10	1/10
Width mm	22.5	22.5	45	45
Height mm	160	160	160	160
Depth mm	115.5	80.2	34.5	34.5
Model No.	9635.200	9635.300	9635.310	9635.320
P. of	4 pc(s).	1 pc(s).	4 pc(s).	4 pc(s).

Component adaptor

Version	P. of	Component adaptor, Comfort			
Rated max. current A		16	25	32	45
Rated operating voltage V		690 (AC), 600 (DC)	690 (AC), 600 (DC)	690 (AC), 600 (DC)	690 (AC), 600 (DC)
Number of poles		3-pole	3-pole	3-pole	3-pole
Connection cables, version		AWG 14	AWG 12	AWG 10	AWG 8
Connection cables, length mm		120	100	100	100
No. of adjustable support rails/height mm		1/10	1/10	1/10	1/10
Width mm		45	45	45	45
Height mm		160	160	160	160
Depth mm		34.5	34.5	34.5	34.5
Model No.	4 pc(s).	9635.330	9635.340	9635.350	9635.360

RiLine Compact



Board Page 256 Busbar connection adaptors/component adaptors Page 257

Function of motor controller:

- For controlling motors as a direct or reversing starter with integral over-ride prevention and emergency-off
- The hybrid technology used facilitates wear-free, frequent switching by semi-conductors
- During operation, mechanical contacts ensure a low heat loss

- Space-saving configuration thanks to the minimal build width

Function of electronic power switch:

- For controlling ohmic loads, such as clocked heating controllers
- The hybrid technology used facilitates wear-free, frequent switching by semi-conductors
- During operation, mechanical contacts ensure a low heat loss

Material:

- Polyamide
- Fire protection corresponding to UL 94-V0

Colour:

- RAL 7035

Note:

- The technical data given here may vary for UL applications.

Motor controller

Rated max. current A	P. of	0,6	2,4	9
Rated operating voltage V		500	500	500
Rated frequency Hz		50/60	50/60	50/60
Heat loss W		2,8	5,5	12
Adjustable current monitoring A		0,075 – 0,6	0,18 – 2,4	1,5 – 9
Number of poles		3-pole	3-pole	3-pole
Connection of round conductors mm ²		0,14 – 2,5	0,14 – 2,5	0,14 – 2,5
Width mm		22,5	22,5	22,5
Height mm		160	160	160
Depth mm		114	114	114
For fuses		10 x 38 mm gR 20 A	10 x 38 mm gR 20 A	10 x 38 mm gR 20 A
Conditional rated short-circuit current I _{cc} kA		5	5	5
Approvals		UL	UL	UL
Model No.	1 pc(s).	9635.400	9635.410	9635.420

Electronic power switch

Rated max. current A	P. of	25	25
Rated operating voltage V		42 – 400	42 – 500
Rated frequency Hz		50/60	50/60
Heat loss W		20	20
Adjustable current monitoring A		16/20/25	16/20/25
Number of poles		3-pole	3-pole
Connection of round conductors mm ²		0,2 – 6	0,2 – 6
Width mm		36	36
Height mm		160	160
Depth mm		130	130
For fuses		10 x 38 mm 32 A	Class CC 30 A
Conditional rated short-circuit current I _{cc} kA		30	30
Approvals		-	UL
Model No.	1 pc(s).	9635.500	9635.510

RiLine Compact

Accessories

Support rail

for component adaptor, Comfort

For attaching equipment and reverser combinations.

Material:

- Polyamide
- Fire protection corresponding to UL 94-V0

Colour:

- RAL 9005

Width mm	P. of	Model No.
45	10 pc(s).	9635.600



Positioner

for component adaptor, Comfort

For attaching equipment and reverser combinations.

Material:

- Polyamide
- Fire protection corresponding to UL 94-V0

Colour:

- RAL 9005

Width mm	Height mm	For switchgear make (model)	P. of	Model No.
45	55	Siemens (S00, S0)	10 pc(s).	9635.610
45	35	Eaton PKZ/PKE size 0	10 pc(s).	9635.620



Mini-PLS busbar system (40 mm)



Component adaptors Page 262 Fuse elements Page 261

Busbar supports, busbar connection adaptors

Material:

- Polyamide (PA 6.6)
- Fire protection corresponding to UL 94-V0

Colour:

- RAL 7035
- RAL 9011 (busbar connection adaptor chassis)

Contact hazard protection

Material:

- Thermally modified hard PVC
- Fire protection corresponding to UL 94-V0

Colour:

- RAL 7035

Mini-PLS busbar supports (3-pole)

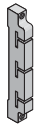

Busbar support, suitable for top mounting	P. of	■			
Bar centre distance mm		40			
Approvals		UR			
Model No.	4 pc(s).	9600.000			

A Mini-PLS special busbars E-Cu, bar thickness 3 mm, bar cross-section 120 mm²

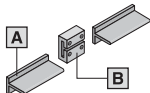

Length mm	P. of	500	700	1100	1500
Approvals		UR	UR	UR	UR
Model No.	3 pc(s).	9601.000	9602.000	9603.000	9624.000

Accessories

B Busbar connectors	Approvals		Model No.
	UR	3 pc(s).	9611.000

Mini-PLS contact hazard protection

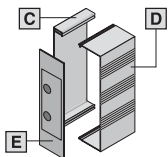

Components	Approvals	Length mm	P. of	Model No.
C Base tray	UR	500	1 pc(s).	9605.000
		700	1 pc(s).	9606.000
		1100	1 pc(s).	9607.000
D Cover section	UR	250	1 pc(s).	9608.000
		500	1 pc(s).	9609.000
E End cover	UR	-	2 pc(s).	9610.000

Mini-PLS busbar connection adaptors (3-pole)

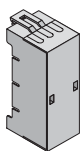

Rated max. current A	P. of	63	250	Page
Rated operating voltage V, ~		690, 3~	690, 3~	
Cable outlet		Top/bottom	Top/bottom	
Connection of round conductors mm ²		1.5 – 35	10 – 120	
Clamping area for laminated copper bars, W x H mm		10 x 8	17 x 15	
Width mm		54	115	
Height mm		160	182	
Approvals		UR	UR	
Model No.	1 pc(s).	9613.000	9612.000	

Accessories

Laminated copper bars		■	■	311
-----------------------	--	---	---	-----

Mini-PLS fuse elements



Busbar system Page 260 Busbar connection adaptor Page 260 Component adaptor Page 262/263

Bus-mounting fuse base

Material:

- Polyamide (PA 6.6)
- Fire protection corresponding to UL 94-V0

Colour:

- Chassis: RAL 9011
- Cover: RAL 7035

NH fuse-switch disconnecter

Material:

- Fibreglass-reinforced polyamide
- Fire protection corresponding to UL 94-V0
- Contact tracks: Silver-plated hard copper

Colour:

- RAL 7035

Basis of test:

- IEC/DIN EN 60 947-3
- DIN EN 60 269-2 (fuse inserts)

Busbar adaptor

Material:

- Polyamide (PA 6.6)
- Fire protection corresponding to UL 94-V0

Colour:

- RAL 9011

Mini-PLS bus-mounting fuse base (3-pole)			A	B
	Fuse insert	P. of	D 02-E18	D 02-E18
	Rated max. current A		63	63
	Rated operating voltage V, ~		400, 3~	400, 3~
	Connection of round conductors mm ²		1.5 – 16	1.5 – 16
	Connection type		Spring terminal	Screw clamp
	Width mm		39.5	38
	Height mm		189	160
	Model No.	1 pc(s).	9630.005	9630.000

NH fuse-switch disconnecter size 000 (3-pole)				
	Rated operating current max. A	P. of	100	Page
	Rated operating voltage V, ~		690, 3~	
	Cable outlet		Top/bottom	
	Connection type		Box terminal	
	Connection of round conductors mm ²		1.5 – 50	
	Clamping area for laminated copper bars, W x H mm		10 x 10	
	Width mm		89	
	Height mm		141.5	
	Model No.	1 pc(s).	3431.000	291

Also required

Mini-PLS busbar adaptor (3-pole)			
With connection cables mm ²		35	
Width mm		90	
Height mm		160	
Model No.	1 pc(s).	9629.100	
Accessories			
Micro-switch	5 pc(s).	3071.000	322

Mini-PLS component adaptor

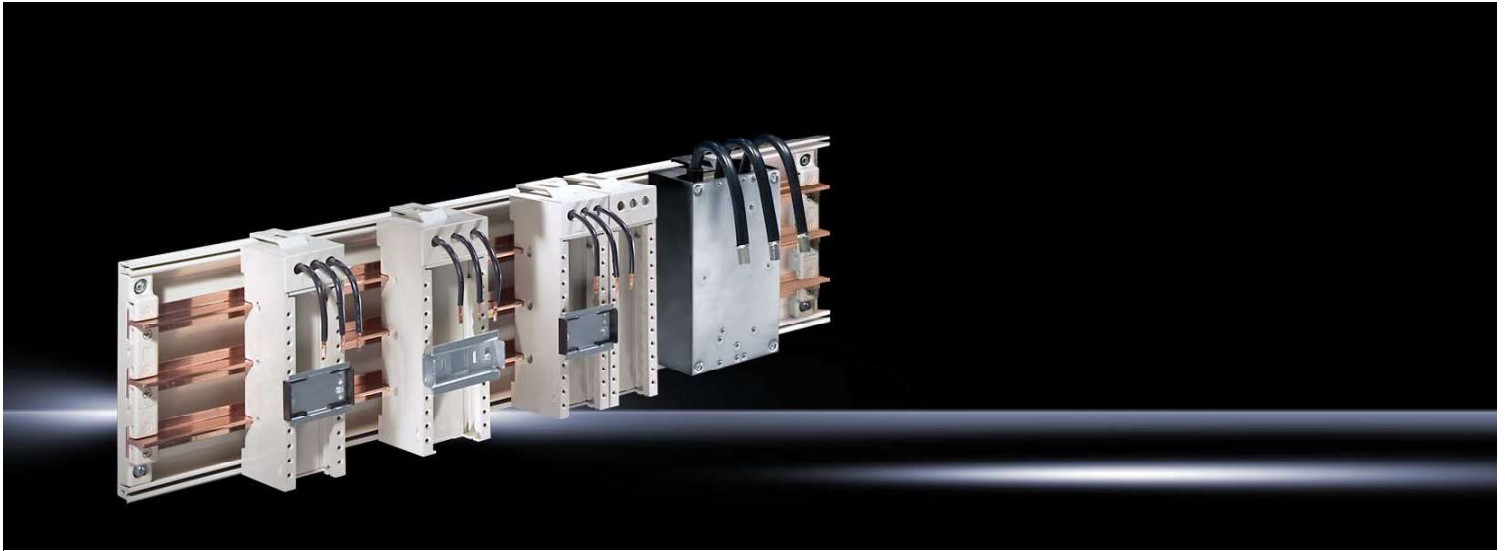

Busbar system Page 260 **Busbar connection adaptor** Page 260 **Fuse elements** Page 261 **Switchgear assignment** Page 263

Material:

- Polyamide (PA 6.6)
- Fire protection corresponding to UL 94-V0

Colour:

- RAL 7035
- RAL 9011 (9629.000)

Rated current max. 12 – 25 A

Rated max. current A	P. of	12	25	25	25	25	25	25	Page	
Rated operating voltage V, ~		690, 3~	690, 3~	690, 3~	690, 3~	690, 3~	690, 3~	690, 3~		
Number of poles		3-pole	3-pole	3-pole	3-pole	3-pole	3-pole	3-pole		
Connection cables		AWG 14	AWG 12	AWG 12	AWG 12	AWG 12	AWG 12	AWG 12		
Support rails quantity/height mm		1/7.5	1/7.5	1/15	1/7.5	1/15	1/7.5	1/7.5		
Width mm		45	45	45	54	54	72	90		
Height mm		160	160	160	160	160	160	160		
Approvals		-	-	-	UR	UR	UR	-		
Model No.	1 pc(s).	9614.110	9614.100	9615.100	9614.000	9615.000	9625.000	9629.010		
Accessories										
Insert strip	2 pc(s).	9623.000	9623.000	9623.000	9623.000	9623.000	9623.000	9623.000	316	
Support rails, height 7.5 mm	Width 45 mm	10 pc(s).	9320.150	9320.150	9320.150	-	-	-	9320.150	316
	Width 54 mm	10 pc(s).	-	-	-	3548.000	3548.000	-	-	316

Mini-PLS component adaptor

Rated current max. 40 – 100 A

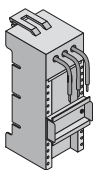
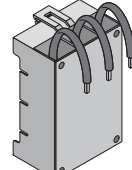
						
Rated max. current A	P. of	40	40	40	100	Page
Rated operating voltage V, ~		690, 3~	690, 3~	690, 3~	690, 3~	
Number of poles		3-pole	3-pole	3-pole	3-pole	
Connection cables		AWG 10	AWG 10	AWG 10	35 mm ²	
Support rails quantity/height mm		1/7.5	1/15	1/7.5	-	
Width mm		54	54	72	90	
Height mm		160	160	160	160	
Approvals		UR	UR	UR	-	
Model No.	1 pc(s).	9616.000	9617.000	9627.000	9629.000	
Accessories						
Insert strip		2 pc(s).	9623.000	9623.000	9623.000	-
Support rails	Height 7.5 mm	Width 54 mm	10 pc(s).	3548.000	3548.000	-
	Height 15 mm	Width 72 mm	5 pc(s).	-	-	-
						9320.120
						316

Switchgear assignment – Mini-PLS component adaptors 12 A/25 A

Make/model	Model No.
ABB	
MS116	9614.100
MS325	9614.000
MS450 (max. 25 A)	9614.000
MS451 (max. 25 A)	9614.000
Eaton	
PKZM0 (up to 25 A)	9614.100
PKZM01 (up to 25 A)	9614.100
PKZM4 (up to 25 A)	9614.000
PKE12	9614.100
PKE32 (up to 25 A)	9614.100
PKE65 (up to 25 A)	9614.000
Schneider Electric	
GV2-P (up to 25 A)	9614.100
GV2-RT	9614.100
GV2-LE10	9614.100
GV3 (up to 25 A)	9614.100

Make/model	Model No.
Siemens	
S0	
3RV10 21...	9614.100
3RV20 21... (up to 25 A)	9614.100
S00	
3RV10 11...	9614.100 ¹⁾
3RV20 11...	9614.100 ¹⁾
S2	
3RV10 31... (up to 25 A)	9614.000

¹⁾ Support rail must be offset

Switchgear assignment – Mini-PLS component adaptors 40 A/100 A

Make/model	Model No.	Accessories Model No.
ABB		
MS450 (max. 40 A)	9617.000	-
MS451 (max. 40 A)	9629.000	9320.120
MS495	9629.000	9320.120
MS496	9629.000	9320.120
MS497	9629.000	9320.120
Tmax		
T1	9629.000	-
T2	9629.000	-
Eaton		
NZM 1	9629.000	-
PKZ2	9627.000	-
PKZM4 (max. 40 A)	9617.000	-
PKZM4	9629.000	9320.120

Make/model	Model No.	Accessories Model No.
Schneider Electric		
NS 80	9629.000	-
GV3 (max. 40 A)	9616.000	-
GV3	9629.000	9320.120
Siemens		
S2		
3RV10 31... (max. 40 A)	9616.000	-
3RV10 31...	9629.000	9320.120
S3		
3RV1341/42	9629.000	9320.120

Rittal – The System.

Faster – better – everywhere.

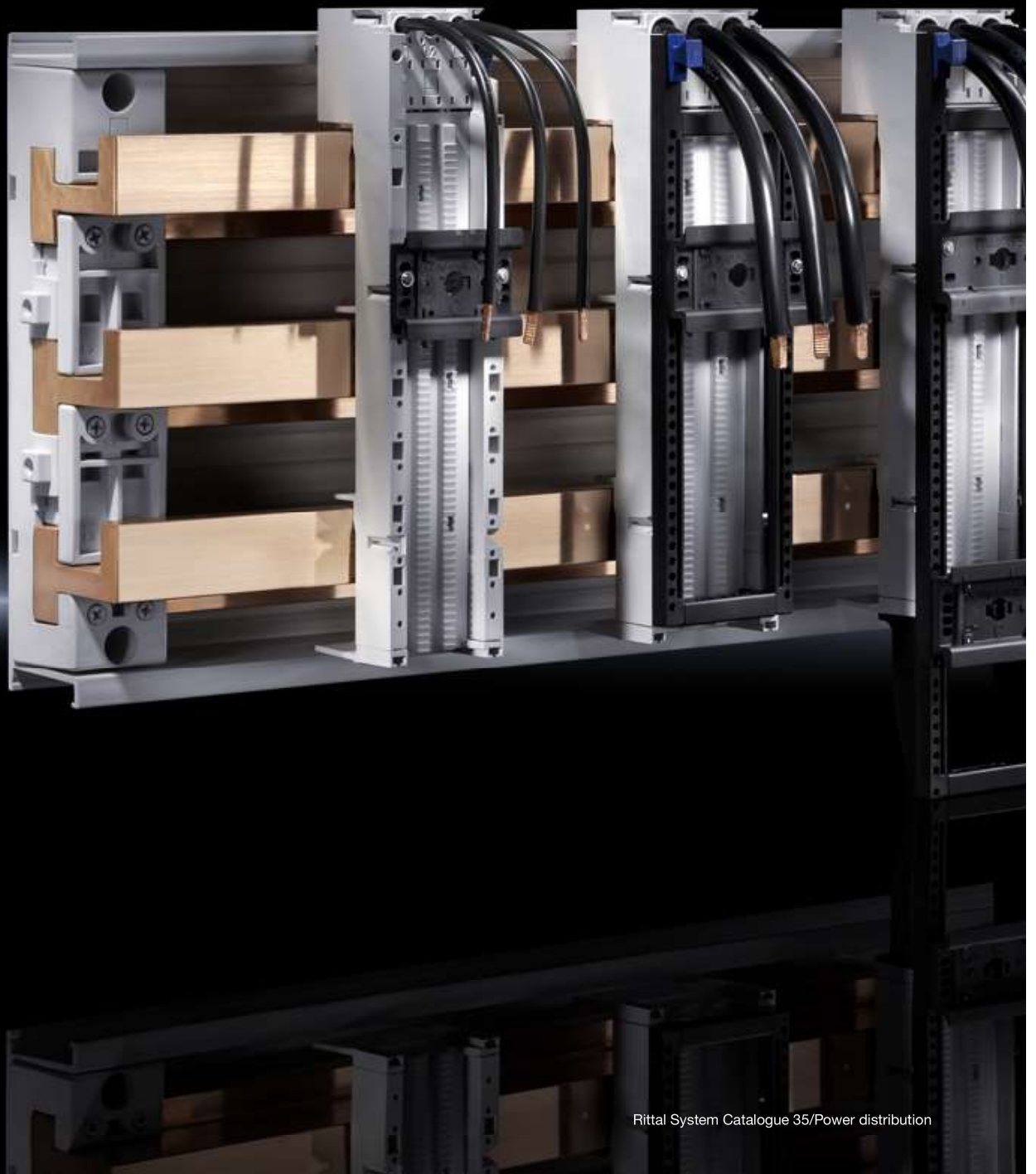

RiLine

Busbar systems 3-/4-pole and DC

Support + bars + contact hazard protection

- Flat copper bar system, see page 266
- PLS busbar system, see page 268
- Accessories, see page 306

Connection system 3- and 4-pole

- Busbar connection adaptor, see page 270
- Connection clamps, see page 313
- Connection block, see page 315
- Accessories, see page 313

Component adaptors 3- and 4-pole

- OM adaptor, see page 273
- Circuit-breaker component adaptor, see page 280
- Accessories, see page 317

Fuse elements 3-pole

- Bus-mounting fuse bases, see page 289
- NH fuse-switch disconnectors, see page 291
- NH slimline fuse-switch disconnectors, see page 301
- Fuse holders, see page 303
- Accessories, see page 321

Rittal Power Engineering with update function

see page 377

- Configuration of RiLine busbar systems
- Simple component selection, integral switchgear database
- Automatic calculation of rated currents and heat losses

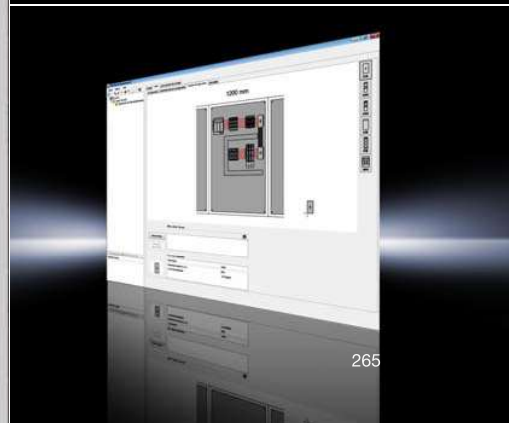

RiLine busbar systems up to 800 A (60 mm)



Busbar connection adaptors Page 270 **Component adaptors** Page 280 **Fuse elements** Page 289

Material:

- Polyamide (PA 6.6)
- Fire protection corresponding to UL 94-V0

Colour:



- RAL 7035

Note:

- UL approval only valid in conjunction with AC applications
- The use of a base tray is required for UL applications.



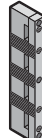

Flat copper busbar system

Busbar supports

						
Number of poles	P. of	3-pole	3-pole	3-pole	4-pole	Page
Bar centre distance mm		60	60	60	60	
External attachment		■	-	-	-	
Internal attachment		-	■	■	■	
For busbars mm	12 x 5/10	■	■	-	■	
	15 x 5 – 30 x 10	■	■	■	■	
Rated operating voltage V, ~		1000, 3~	1000, 3~	1000, 3~	1000, 3~	
		-	-	1500 (DC)	-	
Approvals		-	-	UL	UL	
Model No.	4 pc(s).	9340.010	9340.000	9340.050	9340.004	
Also required						
Spacers when using busbars 12 x 5/10 mm		■	■	-	■	
Model No.	12 pc(s).	9340.090	9340.090	-	9340.090	307

RiLine busbar systems up to 800 A (60 mm)

Flat copper busbar system

Busbar supports						
						
Number of poles	P. of	3-pole	3-pole	3-pole	4-pole	Page
Bar centre distance mm		60	60	60	60	
Model No.	4 pc(s).	9340.010	9340.000	9340.050	9340.004	266
Also required						
Spacer when using busbars 12 x 5/10 mm		■	■	–	■	
Model No.	12 pc(s).	9340.090	9340.090	–	9340.090	307

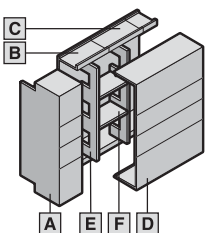
Contact hazard protection									
	Components	Length mm	Approvals	P. of	Model No.			Model No.	Page
	A End covers	–	UL	2 pc(s).	9340.070	9340.070	9340.070	9340.074	–
	B Base trays	500	UL	2 pc(s).	–	9340.100	9340.100	–	312
		700	UL	2 pc(s).	–	9340.110	9340.110	–	312
		900	UL	2 pc(s).	–	9340.120	9340.120	–	312
		1100	UL	2 pc(s).	–	9340.130	9340.130	9340.134	312
		2400	UL	1 pc(s).	–	9340.170	–	–	312
	C Base tray infills	100	UL	2 pc(s).	–	9340.140	9340.140	–	312
D Cover sections	700	UL	2 pc(s).	–	9340.200	9340.200	–	312	
	1100	UL	2 pc(s).	–	9340.210	9340.210	9340.214	312	
E Support panels	–	UL	5 pc(s).	–	9340.220	9340.220	9340.224	312	
F Cross members	160	UL	2 pc(s).	–	–	9340.230	–	312	

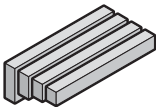
Busbars E-Cu, length: 2400 mm/bar										
	Dimensions mm	Max. rated current A acc. to		Approvals	P. of	Model No.			Model No.	Page
		DIN ¹⁾	UL 508							
	12 x 5	210	160	UL	6 pc(s).	3580.000	3580.000	3580.000	3580.000	308
	12 x 10	340	320	UL	6 pc(s).	3580.100	3580.100	3580.100	3580.100	308
	15 x 5	260	200	UL	6 pc(s).	3581.000	3581.000	3581.000	3581.000	308
	15 x 10	360	400	UL	6 pc(s).	3581.100	3581.100	3581.100	3581.100	308
	20 x 5	274	270	UL	6 pc(s).	3582.000	3582.000	3582.000	3582.000	308
	20 x 10	427	540	UL	3 pc(s).	3585.005	3585.005	3585.005	3585.005	308
	25 x 5	327	330	UL	6 pc(s).	3583.000	3583.000	3583.000	3583.000	308
	30 x 5	379	400	UL	6 pc(s).	3584.000	3584.000	3584.000	3584.000	308
30 x 10	573	810	UL	3 pc(s).	3586.005	3586.005	3586.005	3586.005	308	

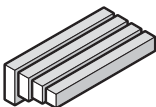
CUPONAL busbars, length: 2400 mm/bar										
	Dimensions mm	Max. rated current A acc. to		Approvals	P. of	Model No.			Model No.	Page
		DIN ¹⁾	UL 508							
	20 x 5	235	–	–	6 pc(s).	–	3582.020	3582.020	–	307
	20 x 10	363	–	–	3 pc(s).	–	3585.020	3585.020	–	307
	30 x 5	328	–	–	6 pc(s).	–	3584.020	3584.020	–	307
30 x 10	493	–	–	3 pc(s).	–	3586.020	3586.020	–	307	

Accessories									
Components	For busbars mm	Approvals	P. of	Model No.			Model No.	Page	
Busbar connectors for single connection	12 x 5 – 15 x 10	UL	3 pc(s).	9350.075	9350.075	9350.075	9350.075	309	
	20 x 5 – 30 x 10	UL	3 pc(s).	9320.020	9320.020	9320.020	9320.020	309	
Busbar connectors for baying connection ²⁾	20 x 5 – 30 x 10	UL	3 pc(s).	9320.030	9320.030	9320.030	9320.030	309	
	12 x 5 – 30 x 10	UR	10 pc(s).	3092.000	3092.000	3092.000	3092.000	308	
Busbar cover sections Length: 1000 mm/section	12/15 x 5	UR	4 pc(s).	9350.010	9350.010	9350.010	9350.010	308	
	12/15 x 10	UR	4 pc(s).	9350.060	9350.060	9350.060	9350.060	308	

¹⁾ Maximum rated value of an exposed, uncovered busbar at a temperature increase of 30 K to DIN 43 671

²⁾ Connection from enclosure to enclosure

RiLine busbar systems 800 A/1600 A (60 mm)

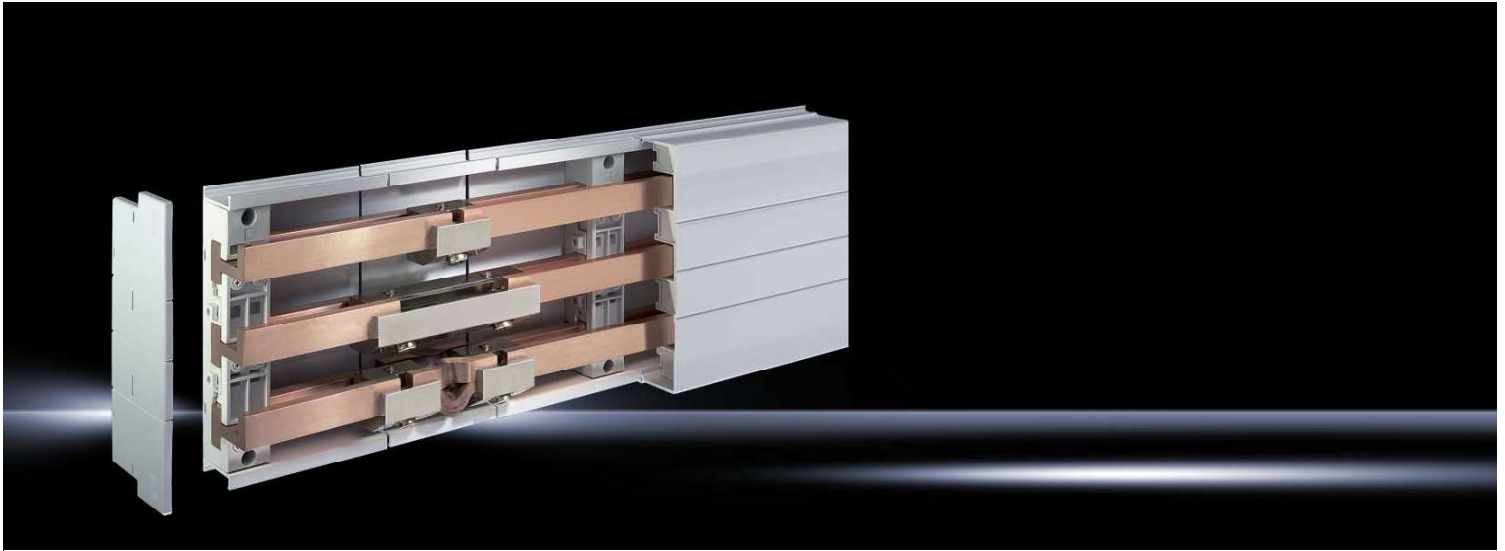

Connection system Page 270 **Component adaptors** Page 280 **Fuse elements** Page 289

Material:

- Polyamide (PA 6.6)
- Fire protection corresponding to UL 94-V0

Colour:





- RAL 7035

Note:

- UL approval only valid in conjunction with AC applications
- The use of a base tray is required for UL applications.



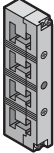

PLS busbar system

Busbar supports

						
		PLS 800		PLS 1600		
For Rittal system	P. of	3-pole	3-pole	3-pole	3-pole	4-pole
Number of poles		3-pole	3-pole	3-pole	3-pole	4-pole
Bar centre distance mm		60	60	60	60	60
Internal attachment		■	■	■	■	■
Busbar support, suitable for top mounting		■	■	■	■	-
Rated operating voltage V, ~		1000, 3~	1000, 3~	1000, 3~	1000, 3~	1000, 3~
		-	1500 (DC)	-	1500 (DC)	-
Approvals		-	UL	-	UL	UL
Model No.	4 pc(s).	9341.000	9341.050	9342.000	9342.050	9342.004

RiLine busbar systems 800 A/1600 A (60 mm)

PLS busbar system

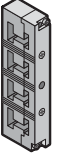
Busbar supports							
							
		PLS 800		PLS 1600			
For Rittal system	P. of						Page
Number of poles		3-pole	3-pole	3-pole	3-pole	4-pole	
Bar centre distance mm		60	60	60	60	60	
Model No.	4 pc(s).	9341.000	9341.050	9342.000	9342.050	9342.004	268

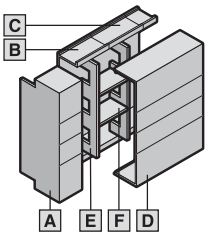
Contact hazard protection										
	Components	Length mm	Approvals	P. of	Model No.		Model No.			Page
	A End covers	–	UL	2 pc(s).	9341.070	9341.070	9342.070	9342.070	9342.074	–
	B Base trays	500	UL	2 pc(s).	9341.100	9341.100	9342.100	9342.100	–	312
		700	UL	2 pc(s).	9341.110	9341.110	9342.110	9342.110	–	312
		900	UL	2 pc(s).	9341.120	9341.120	9342.120	9342.120	–	312
		1100	UL	2 pc(s).	9341.130	9341.130	9342.130	9342.130	9342.134	312
		2400	UL	1 pc(s).	9341.170	–	9342.170	–	–	312
	C Base tray infills	100	UL	2 pc(s).	9341.140	9341.140	9342.140	9342.140	–	312
D Cover sections	700	UL	2 pc(s).	9340.200	9340.200	9340.200	9340.200	–	312	
	1100	UL	2 pc(s).	9340.210	9340.210	9340.210	9340.210	9340.214	312	
E Support panels	–	UL	5 pc(s).	9340.220	9340.220	9340.220	9340.220	9340.224	312	
F Cross members	160	UL	2 pc(s).	–	9340.230	–	9340.230	–	312	

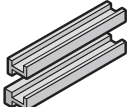
PLS special busbars E-Cu										
	Version			P. of	PLS 800		PLS 1600			Page
	Bar cross-section mm ²				300		900			
	Bar thickness mm				5		10			
	Max. rated current A acc. to	DIN ¹⁾			684		1368			
		UL 508			890		1500			
	Length mm	For enclosure width mm	Approvals		Model No.		Model No.			
	495	600	UL	3 pc(s).	3524.000		3527.000			309
	695	800	UL	3 pc(s).	3525.000		3528.000			309
895	1000	UL	3 pc(s).	3525.010		3528.010			309	
1095	1200	UL	3 pc(s).	3526.000		3529.000			309	
2400	variable	UL	1 pc(s).	3509.000		3516.000			309	

Accessories										
Components			Approvals	P. of	Model No.		Model No.			Page
PLS busbar connectors	Single connection		UL	3 pc(s).	3504.000		3514.000			310
	Bayed connection ²⁾		UL	3 pc(s).	3505.000		3515.000			310
PLS expansion connector ³⁾			UR	3 pc(s).	9320.060		9320.070			310

¹⁾ Maximum rated value of an exposed, uncovered busbar at a temperature increase of 30 K to DIN 43 671

²⁾ Connection from enclosure to enclosure

³⁾ 2 PLS busbar connectors (single connectors) are required to fit one expansion connector

Connection adaptors



Busbar system Page 266 **OM adaptors** Page 273 **Circuit-breaker component adaptors** Page 280 **Fuse elements** Page 289

Material:

- Cover: ABS
- Chassis: Polyamide (PA 6.6).
- Chassis 3439.010: Fibreglass-reinforced, thermoplastic polyester (PBT)
- Fire protection corresponding to UL 94-V0





Colour:

- RAL 7035

Note:

- The technical data may vary for UL applications
- UL approval only applies in conjunction with AC application
- The rated operating voltage for DC applications depends on the busbar arrangement in the busbar support 9340.050/9341.050/9342.050.

Rated current max. 63 – 125 A



							
Rated current max. A	Packs of	63	63	125	125	125	Page
Rated operating voltage V, ~		690, 3~	690, 3~	690, 3~	690, 3~	690, 4~	
Rated operating voltage (L1 + L2) V		-	1000 (DC)	-	1000 (DC)	-	
Rated operating voltage (L1 + L3) V		-	1500 (DC)	-	1500 (DC)	-	
Number of poles		3-pole	3-pole	3-pole	3-pole	4-pole	
Cable outlet		Top	Bottom	Top/bottom	Bottom	Top/bottom	
Connection of round conductors, fine wire with wire end ferrule mm ²		2.5 - 10	2.5 - 10	10 - 25	10 - 25	10 - 25	
Connection of round conductors, multi-wire mm ²		2.5 - 10	2.5 - 10	16 - 35	16 - 35	16 - 35	
Connection of round conductors, single-wire mm ²		2.5 - 10	2.5 - 10	-	-	-	
Clamping area for laminated copper bars (W x H) mm		-	-	10 x 7.8	10 x 7.8	10 x 7.8	
Clamping area for laminated copper bars with 5 mm bar thickness (W x H)		-	-	-	-	-	
Clamping area for laminated copper bars with 10 mm bar thickness (W x H)		-	-	-	-	-	
Width mm		20	20	55	55	75	
Height mm		215	215	210	210	270	
Approvals		UL	UL	UR	UL	UL	
For bar systems with centre-to-centre spacing mm		60	60	60	60	60	
For bar thickness mm		5/10	5/10	5/10	5/10	5/10	
Model No.	1 pc(s).	9342.200	9342.210	9342.220	9342.240	9342.224	

Accessories



Laminated copper bars		-	-	see page	see page	see page	311
Connection adaptor expansion set		-	-	-	-	-	

Connection adaptors

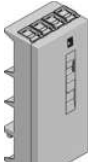
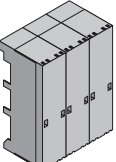
Rated current max. 250 – 600 A

						
Rated current max. A	Packs of	250	250	250	600	Page
Rated operating voltage V, ~		690, 3~	690, 3~	690, 4~	690, 3~	
Rated operating voltage (L1 + L2) V		–	1000 (DC)	–	–	
Rated operating voltage (L1 + L3) V		–	1500 (DC)	–	–	
Number of poles		3-pole	3-pole	4-pole	3-pole	
Cable outlet		Top/bottom	Bottom	Top/bottom	Top/bottom	
Connection of round conductors, fine wire with wire end ferrule mm ²		35 - 120	35 - 120	35 - 120	35 - 240	
Connection of round conductors, multi-wire mm ²		35 - 120	35 - 120	35 - 120	35 - 240	
Connection of round conductors, single-wire		–	–	–	–	
Clamping area for laminated copper bars (W x H) mm		18.5 x 15.5	18.5 x 15.5	18.5 x 15.5	24 x 21	
Clamping area for laminated copper bars with 5 mm bar thickness (W x H)		–	–	–	–	
Clamping area for laminated copper bars with 10 mm bar thickness (W x H)		–	–	–	–	
Width mm		90	90	118	180	
Height mm		210	210	270	247	
Approvals		UL	UL	UL	–	
For bar systems with centre-to-centre spacing mm		60	60	60	60	
For bar thickness mm		5/10	5/10	5/10	5/10	
Model No.	1 pc(s).	9342.250	9342.270	9342.254	3439.010	
Accessories						
Laminated copper bars		see page	see page	see page	see page	311
Connection adaptor expansion set		–	–	–	–	

Rated current max. 800 – 1600 A

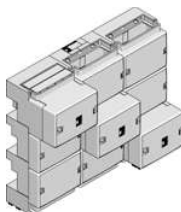
						
Rated current max. A	Packs of	800	800	800	1600	Page
Rated operating voltage V, ~		690, 3~	690, 3~	690, 3~	690, 3~	
Rated operating voltage (L1 + L2) V		–	1000 (DC)	1000 (DC)	1000 (DC)	
Rated operating voltage (L1 + L3) V		–	1500 (DC)	1500 (DC)	1500 (DC)	
Number of poles		3-pole	3-pole	3-pole	3-pole	
Cable outlet		Top/bottom	Top/bottom	Bottom	Top/bottom	
Connection of round conductors, fine wire with wire end ferrule mm ²		95 - 185	95 - 185	95 - 185	–	
Connection of round conductors, multi-wire mm ²		95 - 300	95 - 300	95 - 300	–	
Connection of round conductors, single-wire		–	–	–	–	
Clamping area for laminated copper bars (W x H) mm		33 x 20	–	33 x 20	–	
Clamping area for laminated copper bars with 5 mm bar thickness (W x H) mm		–	33 x 26	–	65 x 27	
Clamping area for laminated copper bars with 10 mm bar thickness (W x H) mm		–	33 x 21	–	65 x 22	
Width mm		129	150	129	255	
Height mm		246	210	246	210	
Approvals		UR	UL	UL	UL	
For bar systems with centre-to-centre spacing mm		60	60	60	60	
For bar thickness mm		5/10	5/10	5/10	5/10	
Model No.	1 pc(s).	9342.280	9342.310	9342.300	9342.320	
Accessories						
Laminated copper bars		see page	see page	see page	see page	311
Connection adaptor expansion set	1 pc(s).	–	9342.314	–	9342.324	272

Connection adaptor expansion set



Busbar system Page 266 **OM adaptors** Page 273 **Circuit-breaker component adaptors** Page 280 **Fuse elements** Page 289

Single-pole extra set to complement the 3-pole connection adaptor for 4-pole configurations.

- Material:**
- Cover: ABS
 - Chassis: Polyamide (PA 6.6).
 - Fire protection corresponding to UL 94-V0

- Colour:**
- RAL 7035

- Note:**
- The technical data may vary for UL applications
 - UL approval only applies in conjunction with AC application

for 4-pole configuration

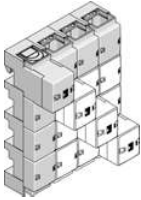
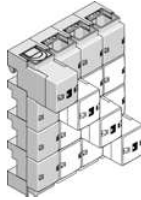
				
To fit Model No.	Packs of	9342.310	9342.320	Page
Rated current max. A		800	1600	
Rated operating voltage V, ~		690, 1~	690, 1~	
Number of poles		Single-pole	Single-pole	
Connection of round conductors, fine wire with wire end ferrule mm ²		95 - 185	-	
Connection of round conductors, multi-wire mm ²		95 - 300	-	
Clamping area for laminated copper bars with 5 mm bar thickness (W x H) mm		33 x 26	65 x 27	
Clamping area for laminated copper bars with 10 mm bar thickness (W x H) mm		33 x 21	65 x 22	
Width mm		50	85	
Height mm		270	270	
Approvals		UL	UL	
For bar systems with centre-to-centre spacing mm		60	60	
For bar thickness mm		5/10	5/10	
Model No.	1 pc(s).	9342.314	9342.324	
Accessories				
Laminated copper bars		see page	see page	311



Busbar system Page 266 **Connection adaptors** Page 270 **Fuse elements** Page 289 **Allocation of switchgear** Page 285

Material:

- Polyamide (PA 6.6)
- Fire protection corresponding to UL 94-V0



Colour:

- Chassis: RAL 7035

Note:





- The technical data may vary for UL applications

Rated current max. 16 A, with connection cables



				
Rated current max. A	Packs of	16	16	Page
Rated operating voltage V, ~		690, 3~	690, 3~	
Number of poles		3-pole	3-pole	
Connection cables, design		AWG 12	AWG 12	
Connection cables, length mm		165	165	
With support frame mm		45 x 170	45 x 237	
With support frame support		-	■	
With PinBlock		-	■	
With insert strips		-	-	
Support rails Qty/height mm		2 / 10	1 / 10	
Support rail version		TS 45D TS 45D-V	TS 45D	
Width mm		45	45	
Height mm		208	272	
Approvals		-	UL	
For bar systems with centre-to-centre spacing mm		60	60	
For bar thickness mm		5/10	5/10	
Model No.	1 pc(s).	9340.780	9340.760	
Accessories				
Connection pin	20 pc(s).	9340.280	9340.280	318
Insert strip	2 pc(s).	9340.290	9340.290	318
Support rails 35 x 10 mm		see page	see page	317
OM supports		see page	see page	279
PinBlock	5 pc(s).	9342.800	-	318

OM adaptors

Rated current max. 25 A, with connection cables

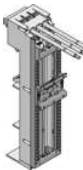
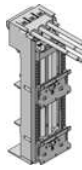
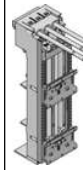
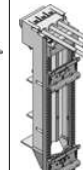

							
Rated current max. A	Packs of	25	25	25	25	25	Page
Rated operating voltage V, ~		690, 3~	690, 3~	690, 3~	690, 3~	690, 3~	
Number of poles		3-pole	3-pole	3-pole	3-pole	3-pole	
Connection cables, design		AWG 12	AWG 12	AWG 12	AWG 12	AWG 12	
Connection cables, length mm		130	130	130	130	130	
With support frame mm		-	45 x 170	45 x 170	-	45 x 170	
With support frame support		-	-	-	-	-	
With PinBlock		-	-	■	-	-	
With insert strips		-	-	-	-	-	
Support rails Qty/height mm		1 / 10	1 / 10	1 / 10	2 / 10	3 / 10	
Support rail version		TS 45C	TS 45C	TS 45C	TS 45D	TS 45D TS 45D-V	
Width mm		45	45	45	45	90	
Height mm		208	208	208	208	208	
Approvals		UL	UL	UL	UL	UL	
For bar systems with centre-to-centre spacing mm		60	60	60	60	60	
For bar thickness mm		5/10	5/10	5/10	5/10	5/10	
Model No.	1 pc(s).	9340.310	9340.340	9340.370	9340.320	9340.400	
Accessories							
Connection pin	20 pc(s).	9340.280	9340.280	9340.280	9340.280	-	318
Insert strip	2 pc(s).	9340.290	9340.290	9340.290	9340.290	-	318
Support rails 35 x 10 mm		see page	see page	see page	see page	see page	317
OM supports		see page	see page	see page	see page	-	279
PinBlock	5 pc(s).	-	9342.800	-	-	9342.800	318

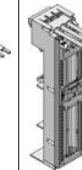
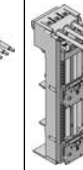
Rated current max. 32 A, with connection cables

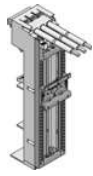

									
Rated current max. A	Packs of	32	32	32	32	32	32	32	Page
Rated operating voltage V, ~		690, 3~	690, 3~	690, 3~	690, 3~	690, 3~	690, 3~	690, 3~	
Number of poles		3-pole	3-pole	3-pole	3-pole	3-pole	3-pole	3-pole	
Connection cables, design		AWG 10	AWG 10	AWG 10	AWG 10	AWG 10	AWG 10	AWG 10	
Connection cables, length mm		130	130	165	130	165	130	130	
With support frame mm		45 x 170	45 x 170	45 x 170	45 x 237	45 x 237	55 x 170	55 x 170	
With support frame support		-	-	-	■	■	-	-	
With PinBlock		-	-	-	-	■	-	-	
With insert strips		-	-	-	-	-	-	-	
Support rails Qty/height mm		1 / 10	2 / 10	2 / 10	2 / 10	1 / 10	1 / 10	2 / 10	
Support rail version		TS 45C	TS 45D TS 45D-V	TS 45D TS 45D-V	TS 45D TS 45D-V	TS 45D	TS 55D	TS 55D TS 55D-V	
Width mm		45	45	45	45	45	55	55	
Height mm		208	208	208	272	272	208	208	
Approvals		UL	UL	-	UL	UL	UL	UL	
For bar systems with centre-to-centre spacing mm		60	60	60	60	60	60	60	
For bar thickness mm		5/10	5/10	5/10	5/10	5/10	5/10	5/10	
Model No.	1 pc(s).	9340.350	9340.380	9340.790	9340.390	9340.770	9340.460	9340.470	
Accessories									
Connection pin	20 pc(s).	9340.280	9340.280	9340.280	9340.280	9340.280	9340.280	9340.280	318
Insert strip	2 pc(s).	9340.290	9340.290	9340.290	9340.290	9340.290	9340.290	9340.290	318
Support rails 35 x 10 mm		see page	see page	see page	see page	see page	see page	see page	317
OM supports		see page	see page	see page	see page	see page	see page	see page	279
PinBlock	5 pc(s).	9342.800	9342.800	9342.800	9342.800	9342.800	9342.810	9342.810	318

OM adaptors

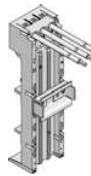
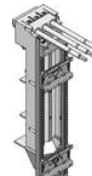
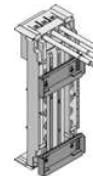
Rated current max. 40 A, with connection cables

							
Rated current max. A	Packs of	40	40	40	40	40	Page
Rated operating voltage V, ~		690, 3~	690, 3~	690, 3~	690, 3~	690, 3~	
Number of poles		3-pole	3-pole	3-pole	3-pole	3-pole	
Connection cables, design		AWG 8	AWG 8	AWG 8	AWG 8	AWG 8	
Connection cables, length mm		130	130	130	130	130	
With support frame mm		55 x 170	-	-	55 x 237	-	
With support frame support		-	-	-	■	-	
With PinBlock		-	-	-	-	-	
With insert strips		-	-	-	-	■	
Support rails Qty/height mm		1 / 10	2 / 10	1 / 15	2 / 10	2 / 7.5	
Support rail version		TS 55D	TS 55D	Metal	TS 55D TS 55D-V	Metal	
Width mm		55	55	55	55	75	
Height mm		208	208	208	272	208	
Approvals		UL	UL	UL	UL	UL	
For bar systems with centre-to-centre spacing mm		60	60	60	60	60	
For bar thickness mm		5/10	5/10	5/10	5/10	5/10	
Model No.	1 pc(s).	9340.720	9340.740	9340.750	9340.730	9340.710	
Accessories							
Connection pin	20 pc(s).	9340.280	9340.280	9340.280	9340.280	9340.280	318
Insert strip	2 pc(s).	9340.290	9340.290	9340.290	9340.290	-	318
Support rails 35 x 10 mm		see page	see page	see page	see page	-	317
OM supports		see page	see page	see page	see page	see page	279
PinBlock	5 pc(s).	9342.810	-	-	9342.810	-	318

Rated current max. 65 A, with connection cables

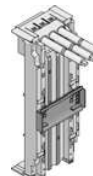
						
Rated current max. A	Packs of	65	65	65	65	Page
Rated operating voltage V, ~		690, 3~	690, 3~	690, 3~	690, 3~	
Number of poles		3-pole	3-pole	3-pole	3-pole	
Connection cables, design		AWG 6	AWG 6	AWG 6	AWG 6	
Connection cables, length mm		130	130	130	130	
With support frame mm		-	55 x 170	55 x 237	-	
With support frame support		-	-	■	-	
With PinBlock		-	-	-	-	
With insert strips		-	-	-	■	
Support rails Qty/height mm		1 / 10	1 / 10	2 / 10	1 / 7.5	
Support rail version		TS 55E	TS 55E	TS 55E TS 55D-V	Metal	
Width mm		55	55	55	75	
Height mm		208	208	272	208	
Approvals		UL	UL	UL	UL	
For bar systems with centre-to-centre spacing mm		60	60	60	60	
For bar thickness mm		5/10	5/10	5/10	5/10	
Model No.	1 pc(s).	9340.410	9340.430	9340.450	9340.700	
Accessories						
Connection pin	20 pc(s).	9340.280	9340.280	9340.280	-	318
Insert strip	2 pc(s).	9340.290	9340.290	9340.290	-	318
Support rails 35 x 10 mm		see page	see page	see page	-	317
OM supports		see page	see page	see page	see page	279
PinBlock	5 pc(s).	-	9342.810	9342.810	-	318

OM adaptors



Busbar system Page 266 **Connection adaptors** Page 270 **Fuse elements** Page 289 **Allocation of switchgear** Page 285





Material:

- Polyamide (PA 6.6)
- Fire protection corresponding to UL 94-V0



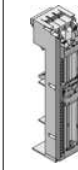

Colour:

- Chassis: RAL 7035

Rated current max. 32 A, with tension spring clamp

								
Rated current max. A	Packs of	32	32	32	32	32	32	Page
Rated operating voltage V, ~		690, 3~	690, 3~	690, 3~	690, 3~	690, 3~	690, 3~	
Number of poles		3-pole	3-pole	3-pole	3-pole	3-pole	3-pole	
Connection of round conductors mm ²		1.5 - 6	1.5 - 6	1.5 - 6	1.5 - 6	1.5 - 6	1.5 - 6	
With support frame mm		-	-	45 x 170	45 x 170	45 x 237	55 x 170	
With support frame support		-	-	-	-	■	-	
With PinBlock		-	-	-	■	-	-	
Support rails Qty/height mm		1 / 10	2 / 10	1 / 10	1 / 10	2 / 10	1 / 10	
Support rail version		TS 45C	TS 45D	TS 45C	TS 45C	TS 45D TS 45D-V	TS 55D	
Width mm		45	45	45	45	45	55	
Height mm		208	208	208	208	272	208	
For bar systems with centre-to-centre spacing mm		60	60	60	60	60	60	
For bar thickness mm		5/10	5/10	5/10	5/10	5/10	5/10	
Model No.	1 pc(s).	9340.510	9340.520	9340.530	9340.550	9340.560	9340.660	
Accessories								
Cable set		see page	see page	see page	see page	see page	see page	319
Twin cords		-	-	-	-	-	-	
Connection pin	20 pc(s).	9340.280	9340.280	9340.280	9340.280	9340.280	9340.280	318
Insert strip	2 pc(s).	9340.290	9340.290	9340.290	9340.290	9340.290	9340.290	318
Support rails 35 x 10 mm		see page	see page	see page	see page	see page	see page	317
OM supports		see page	see page	see page	see page	see page	see page	279
PinBlock	5 pc(s).	-	-	9342.800	9342.800	9342.800	9342.810	318

Rated current max. 65 A, with tension spring clamp

						
Rated current max. A	Packs of	65	65	65	65	Page
Rated operating voltage V, ~		690, 3~	690, 3~	690, 3~	690, 3~	
Number of poles		3-pole	3-pole	3-pole	3-pole	
Connection of round conductors mm ²		2.5 - 16	2.5 - 16	2.5 - 16	2.5 - 16	
According to a heat dissipation test to IEC 61 439-1, a current carrying capacity of up to 80 A is supported		■	■	■	■	
With support frame mm		-	-	55 x 170	55 x 237	
With support frame support		-	-	-	■	
With PinBlock		-	-	-	-	
Support rails Qty/height mm		1 / 10	2 / 10	1 / 10	2 / 10	
Support rail version		TS 55E	TS 55E TS 55D	TS 55E	TS 55E TS 55D-V	
Width mm		55	55	55	55	
Height mm		208	208	208	272	
For bar systems with centre-to-centre spacing mm		60	60	60	60	
For bar thickness mm		5/10	5/10	5/10	5/10	
Model No.	1 pc(s).	9340.610	9340.620	9340.630	9340.650	
Accessories						
Cable set		see page	see page	see page	see page	319
Twin cords		see page	see page	see page	see page	319
Connection pin	20 pc(s).	9340.280	9340.280	9340.280	9340.280	318
Insert strip	2 pc(s).	9340.290	9340.290	9340.290	9340.290	318
Support rails 35 x 10 mm		see page	see page	see page	see page	317
OM supports		see page	see page	see page	see page	279
PinBlock	5 pc(s).	-	-	9342.810	9342.810	318

New



Push-in conductor connection clamps

see page 313

OM adaptors



Busbar system Page 266 **Connection adaptors** Page 270 **Fuse elements** Page 289



Material:

- Polyamide (PA 6.6)
- Fire protection corresponding to UL 94-V0

Colour:

- Chassis: RAL 7035

Rated current max. 25 A, with plug-in cable outlet

				
Rated current max. A	Packs of	25	25	Page
Rated operating voltage V, ~		690, 3~	690, 3~	
Number of poles		3-pole	3-pole	
Connection of round conductors mm ²		1.5 - 4	1.5 - 4	
With support frame mm		45 x 170	55 x 170	
Support rails Qty/height mm		2 / 10	2 / 10	
Support rail version		TS 45D TS 45D-V	TS 55D TS 55D-V	
Width mm		45	55	
Height mm		208	208	
Approvals		UL	UL	
For bar systems with centre-to-centre spacing mm		60	60	
For bar thickness mm		5/10	5/10	
Model No.	1 pc(s).	9340.910	9340.930	
Product-specific scope of supply				
Connector with connection facility for 3 main contacts (1.5 – 4 mm ²)		■	■	
Accessories				
Cable set		see page	see page	319
Support rails 35 x 10 mm		see page	see page	317



Busbar system Page 266 **Connection adaptors** Page 270 **Fuse elements** Page 289

For mounting of switchgear with external power supply.

Material:
 – Polyamide (PA 6.6)
 – Fire protection corresponding to UL 94-V0

Colour:
 – Chassis: RAL 7035

without contact system

					
Number of poles	Packs of	3-pole	3-pole	3-pole	Page
With support frame mm		45 x 170	55 x 237	–	
With support frame support		–	■	–	
With PinBlock		■	–	–	
Support rails Qty/height mm		–	1 / 10	2 / 10	
Support rail version		–	TS 55D-V	TS 45D	
Width mm		45	55	45	
Height mm		208	272	208	
Approvals		UL	UL	UL	
For bar systems with centre-to-centre spacing mm		60	60	60	
For bar thickness mm		5/10	5/10	5/10	
Model No.	1 pc(s).	9340.260	9340.270	9340.300	
Accessories					
Connection pin	20 pc(s).	9340.280	9340.280	9340.280	318
Insert strip	2 pc(s).	9340.290	9340.290	9340.290	318
Support rails 35 x 10 mm		see page	see page	see page	317

Circuit-breaker component adaptors



Busbar system Page 266 **Connection adaptors** Page 270 **Fuse elements** Page 289

Material:

- Polyamide (PA 6.6)
- Fire protection corresponding to UL 94-V0

Colour:





- RAL 7035

Note:

- Cable outlet: Switch outlet or as outgoing cable from the switchgear

- The technical data may vary for UL applications

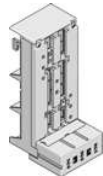
Rated current max. 100 – 125 A, 3-pole

						
Rated current max. A	Packs of	100	100	125	125	Page
Rated operating voltage V, ~		690, 3~	690, 3~	690, 3~	690, 3~	
Number of poles		3-pole	3-pole	3-pole	3-pole	
Cable outlet		Top	Bottom	Top	Bottom	
Type of connection		Box terminal	Box terminal	Box terminal	Box terminal	
Connection of round conductors mm ²		10 - 35	10 - 35	35 - 120	35 - 120	
Clamping area for laminated copper bars (W x H) mm		10 x 7.8	10 x 7.8	18.5 x 15.5	18.5 x 15.5	
For switchgear make (model)		ABB (MS 495, MS 496, MS 497) Eaton (PKZ2) Schneider Electric (GV3ME80) Siemens (S3)	ABB (MS 495, MS 496, MS 497) Eaton (PKZ2) Schneider Electric (GV3ME80) Siemens (S3)	ABB (S1, S2, T1, T1 UL, T2, T2 UL, XT1, XT2) Allen Bradley (140-CMN) Eaton (NZM1, NZM1 UL, BZM B1) GE (FD160) OEZ (BC160N) Schneider Electric (NS80, NSC100, NSE75, NSE100, NSX100) Schrack (MC1) Siemens (3RV13 53, 3VT1, 3VA10, 3VA11, 3VA51) Terasaki (E125, S125)	ABB (S1, S2, T1, T1 UL, T2, T2 UL, XT1, XT2) Allen Bradley (140-CMN) Eaton (NZM1, NZM1 UL, BZM B1) GE (FD160) OEZ (BC160N) Schneider Electric (NS80, NSC100, NSE75, NS100, NSX100) Schrack (MC1) Siemens (3RV13 53, 3VT1, 3VA10, 3VA11, 3VA51) Terasaki (E125, S125)	
Width mm		72	72	90	90	
Height mm		210	210	225	225	
Approvals		UL	UL	UL	UL	
For bar systems with centre-to-centre spacing mm		60	60	60	60	
For bar thickness mm		5/10	5/10	5/10	5/10	
Model No.	1 pc(s).	9342.400	9342.410	9342.540	9342.550	
Product-specific scope of supply						
Terminal cover		-	-	■	■	
Sliding blocks		-	-	■	■	
Accessories						
Support rails 35 x 15 mm	5 pc(s).	9320.120	9320.120	-	-	320
Connection bracket	3 pc(s).	-	-	9342.570	9342.570	320
Insert strip		-	-	-	-	



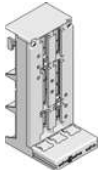
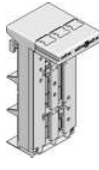
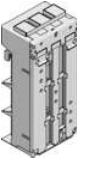
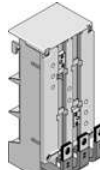
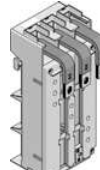

Circuit-breaker component adaptors

Rated current max. 160 – 250 A, 3-pole

							
Rated current max. A	Packs of	160	160	250	250	250	Page
Rated operating voltage V, ~		690, 3~	690, 3~	690, 3~	690, 3~	690, 3~	
Number of poles		3-pole	3-pole	3-pole	3-pole	3-pole	
Cable outlet		Top	Bottom	Bottom	Top	Bottom	
Type of connection		Box terminal	Box terminal	Box terminal	-	-	
Connection of round conductors mm ²		35 - 120	35 - 120	35 - 120	-	-	
Clamping area for laminated copper bars (W x H) mm		18.5 x 15.5	18.5 x 15.5	18.5 x 15.5	-	-	
For switchgear make (model)		ABB (S1, S2, T1, T2, XT1, XT2) Allen Bradley (140-CMN) Eaton (N2M1, B2M B1) GE (FD160) Legrand (DPX 125, DPX 160) OZ (BC160N) Schneider Electric (NS80, NSC100, NSX100) Schrack (MC1) Siemens (3RV13 53, 3VT1, 3VA10, 3VA11) Terasaki (E125, S125)	ABB (S1, S2, T1, T2, XT1, XT2) Allen Bradley (140-CMN) Eaton (N2M1, B2M B1) GE (FD160) Legrand (DPX 125, DPX 160) OZ (BC160N) Schneider Electric (NS80, NSC100, NSX100) Schrack (MC1) Siemens (3RV13 53, 3VT1, 3VA10, 3VA11) Terasaki (E125, S125)	ABB (S3, T3, T4/320 A, T3 UL, T4 UL, XT3, XT4) Allen Bradley (140U-J) Eaton (N2M2, N2M2 UL, B2M B2) GE (FE160, FE250, FD160) Legrand (DPX 250) Mitsubishi (NF125-SGW/HGW, NF160-SGW/HGW) OZ (BD250N, BD250S) Schneider Electric (NS(X)100, NS(X)160, NS(X)250, GV7, NSF150, NSF250) Schrack (MC2) Siemens (VL150(X) UL, VL160(X), VL250, VL250 UL, 3RV10 63, 3RV13 63, 3RV13 64, 3VT2, 3VA12/20/21/22, 3VA52/61/62) Terasaki (H125, L125, H160, L160, S160, E250, H250, L250)	ABB (S3, T3, T4/320 A, T3 UL, T4 UL, XT3, XT4) Allen Bradley (140U-J) Eaton (N2M2, N2M2 UL, B2M B2) GE (FE160, FE250, FD160) Legrand (DPX 250) Mitsubishi (NF125-SGW/HGW, NF160-SGW/HGW) OZ (BD250N, BD250S) Schneider Electric (NS(X)100, NS(X)160, NS(X)250, GV7, NSF150, NSF250) Schrack (MC2) Siemens (VL150(X) UL, VL160(X), VL250, VL250 UL, 3RV10 63, 3RV13 63, 3RV13 64, 3VT2, 3VA12/20/21/22, 3VA52/61/62) Terasaki (H125, L125, H160, L160, S160, E250, H250, L250)	ABB (S3, T3, T4/320 A, T3 UL, T4 UL, XT3, XT4) Allen Bradley (140U-J) Eaton (N2M2, N2M2 UL, B2M B2) GE (FE160, FE250, FD160) Legrand (DPX 250) Mitsubishi (NF125-SGW/HGW, NF160-SGW/HGW) OZ (BD250N, BD250S) Schneider Electric (NS(X)100, NS(X)160, NS(X)250, GV7, NSF150, NSF250) Schrack (MC2) Siemens (VL150(X) UL, VL160(X), VL250, VL250 UL, 3RV10 63, 3RV13 63, 3RV13 64, 3VT2, 3VA12/20/21/22, 3VA52/61/62) Terasaki (H125, L125, H160, L160, S160, E250, H250, L250)	
Width mm		90	90	105	105	105	
Height mm		215	215	240	240	240	
Approvals		-	-	UL	UL	UL	
For bar systems with centre-to-centre spacing mm		60	60	60	60	60	
For bar thickness mm		5/10	5/10	5/10	5/10	5/10	
Model No.	1 pc(s).	9342.500	9342.510	9342.610	9345.600	9345.610	
Product-specific scope of supply							
Terminal cover		■	■	■	-	-	
Sliding blocks		■	■	■	■	■	
Connection straps		-	-	-	■	■	
Accessories							
Support rails 35 x 15 mm		-	-	-	-	-	
Connection bracket	3 pc(s).	9342.570	9342.570	-	-	-	320
Insert strip		-	-	-	-	-	

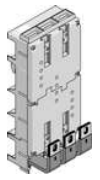
Circuit-breaker component adaptors

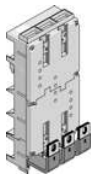
Rated current max. 400 – 630 A, 3-pole

						
Rated current max. A	Packs of	400	400	630	630	Page
Rated operating voltage V, ~		690, 3~	690, 3~	690, 3~	690, 3~	
Number of poles		3-pole	3-pole	3-pole	3-pole	
Cable outlet		Top	Bottom	Top	Bottom	
Type of connection		-	-	-	-	
Connection of round conductors		-	-	-	-	
Clamping area for laminated copper bars (W x H)		-	-	-	-	
When using the Siemens VL630 switchgear, insert strip 9342.720 is additionally required		-	-	■	■	
For switchgear make (model)		Eaton (NZM3, NZM3 UL/400 A) GE (FG400) Mitsubishi (NF400-SEW/HEW/REW) Schneider Electric (NS(X)400, NSJ400) Schrack (MC3) Siemens (VL400, VL400X UL, VL400 UL, 3VA23, 3VA63) Terasaki (E400, S400, H400, L400)	Eaton (NZM3, NZM3 UL/400 A) GE (FG400) Mitsubishi (NF400-SEW/HEW/REW) Schneider Electric (NS(X)400, NSJ400) Schrack (MC3) Siemens (VL400, VL400X UL, VL400 UL, 3VA23, 3VA63) Terasaki (E400, S400, H400, L400)	ABB (S5, T5, T5 UL) Allen Bradley (140U-L) Eaton (NZM3, NZM3 UL/630 A) GE (FG630) Legrand (DPX 630) Mitsubishi (NF630-SEW/HEW/REW) OEZ (BH630N, BH630S) Schneider Electric (NS(X)630, NSJ600) Schrack (MC3) Siemens (VL630, 3VA24, 3VT3, 3V10 73, 3RV13 73, 3RV13 74, 3VA64) Terasaki (E630, S630)	ABB (S5, T5, T5 UL) Allen Bradley (140U-L) Eaton (NZM3, NZM3 UL/630 A) GE (FG630) Legrand (DPX 630) Mitsubishi (NF630-SEW/HEW/REW) OEZ (BH630N, BH630S) Schneider Electric (NS(X)630, NSJ600) Schrack (MC3) Siemens (VL630, 3VA24, 3VT3, 3V10 73, 3RV13 73, 3RV13 74, 3VA64) Terasaki (E630, S630)	
Width mm		140	140	140	140	
Height mm		345	345	345	345	
Approvals		UL	UL	UL	UL	
For bar systems with centre-to-centre spacing mm		60	60	60	60	
For bar thickness mm		5/10	5/10	5/10	5/10	
Model No.	1 pc(s).	9345.720	9345.730	9345.700	9345.710	
Product-specific scope of supply						
Connection straps		■	■	■	■	
Sliding blocks		■	■	■	■	
Accessories						
Support rails 35 x 15 mm		-	-	-	-	
Connection bracket		-	-	-	-	
Insert strip	4 pc(s).	9342.720	9342.720	9342.720	9342.720	320

Circuit-breaker component adaptors



Busbar system Page 266 Connection adaptors Page 270

Material:

- Polyamide (PA 6.6)
- Fire protection corresponding to UL 94-V0



Colour:

- RAL 7035

Note:

- Cable outlet: Switch outlet or as outgoing cable from the switchgear
- The technical data may vary for UL applications

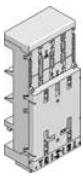
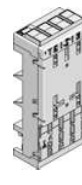
Rated current max. 160 – 250 A, 4-pole

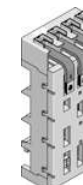
						
Rated current max. A	Packs of	160	160	250	250	Page
Rated operating voltage V, ~		690, 4~	690, 4~	690, 4~	690, 4~	
Number of poles		4-pole	4-pole	4-pole	4-pole	
Cable outlet		Top	Bottom	Top	Bottom	
Type of connection		Box terminal	Box terminal	-	-	
Connection of round conductors mm ²		35 - 120	35 - 120	-	-	
Clamping area for laminated copper bars (W x H) mm		18.5 x 15.5	18.5 x 15.5	-	-	
For switchgear make (model)		ABB (T1, T2, XT1, XT2) Eaton (NZM1-4/125 A, BZM E1-4/100 A) Schneider Electric (NSC100) Schrack (MC1) Siemens (3VA10, 3VA11)	ABB (T1, T2, XT1, XT2) Eaton (NZM1-4/125 A, BZM E1-4/100 A) Schneider Electric (NSC100) Schrack (MC1) Siemens (3VA10, 3VA11)	ABB (T3S, XT3) Eaton (NZM2-4/250 A) Schneider Electric (NS(X)100, NS(X)160, NS(X)250) Schrack (MC2) Siemens (VL160X, VL160, VL250, 3RV10 63, 3VA12/20/ 21/22, 3VA61/62)	ABB (T3S, XT3) Eaton (NZM2-4/250 A) Schneider Electric (NS(X)100, NS(X)160, NS(X)250) Schrack (MC2) Siemens (VL160X, VL160, VL250, 3RV10 63, 3VA12/20/ 21/22, 3VA61/62)	
Width mm		120	120	140	140	
Height mm		277	277	310	310	
Approvals		UL	UL	-	-	
For bar systems with centre-to-centre spacing mm		60	60	60	60	
For bar thickness mm		5/10	5/10	5/10	5/10	
Model No.	1 pc(s).	9342.504	9342.514	9345.604	9345.614	
Product-specific scope of supply						
Terminal cover		■	■	-	-	
Sliding blocks		■	■	■	■	
Connection straps		-	-	■	■	

Circuit-breaker component adaptors

Rated current max. 500 A, 4-pole

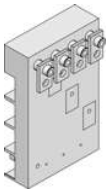
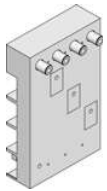
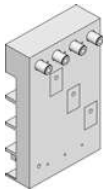
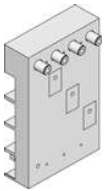
						
Rated current max. A	Packs of	500	500	500	500	Page
Rated operating voltage V, ~		690, 4~	690, 4~	690, 4~	690, 4~	
Number of poles		4-pole	4-pole	4-pole	4-pole	
Cable outlet		Bottom	Bottom	Bottom	Bottom	
Type of connection		-	-	-	-	
Connection of round conductors		-	-	-	-	
Clamping area for laminated copper bars (W x H)		-	-	-	-	
For switchgear make (model)		ABB (Tmax T5)	Schneider Electric (NS(X)400, NS(X)630)	Eaton (NZM3-4-XKR130)	Siemens (VL400)	
Width mm		185	185	185	185	
Height mm		300	300	300	300	
Approvals		-	-	-	-	
For bar systems with centre-to-centre spacing mm		60	60	60	60	
For bar thickness mm		5/10	5/10	5/10	5/10	
Model No.	1 pc(s).	9345.704	9345.714	9345.724	9345.734	
Product-specific scope of supply						
Spacer rolls		■	■	■	■	
Connection screws		■	■	■	■	
Contact plates		■	-	-	-	



Accessories



Power Engineering

see page 377

OM adaptors with connection cables

Switchgear assignment

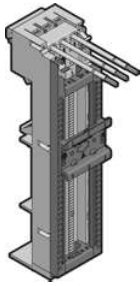

For make/model		ABB										Eaton																			
		Circuit-breaker				Starter			Reversing starter		Soft starter	Circuit-breaker					Starter			Reversing starter	Soft starter										
		MS 116/132	MS 325	MS 450/451	MS 495/496/497	MS 116 + AF09, AF12, AF16	MS 132 + AF09, AF12, AF16, AF26, AF30, AF38	MS 450 + A40, A50	MS 116 + AF09, AF12, AF16	MS 132 + AF09, AF12, AF16, AF26, AF30, AF38	MS 450 + A40, A50	MS 116 + PSR3, PSR6, PSR9, PSR12, PSR16, PSR25	MS 325 + PSR25	MS 450 + PSR30	PKZM0	PKZM01	PKZM4	PKE12	PKE32	PKE65	MSC-D + M7 - M15	MSC-D + M17 - M32	PKZM4 + DILM 17-65	MSC - DE ... M7 - M12	MSC - DE ... M17 - M32	PKE 65 + DILM 65	MSC - DE ... M7 - M12	MSC - DE ... M17 - M32	PKE 65 + DILM 65	PKE 12, PKE 32 + DS7-340	PKZ0 + DS7-340
		Construction width										Construction width																			
		45	54	55	70	45	45	70	90	90	140	45	45	55	45	45	55	45	45	55	45	45	55	45	55	90	90	110	45	45	
Model No.	Version	Required quantity (pieces)										Required quantity (pieces)																			
9340.340	OM adaptor 25 A, AWG 12, W = 45 mm	1													1		1	1													
9340.350	OM adaptor 32 A, AWG 10, W = 45 mm					1								1																	
9340.370	OM adaptor 25 A, AWG 12, W = 45 mm							1												1						1					
9340.380	OM adaptor 32 A, AWG 10, W = 45 mm																				1						1				
9340.390	OM adaptor 32 A, AWG 10, W = 45 mm					1			1		1	1										1	1						1	1	
9340.430	OM adaptor 65 A, AWG 6, W = 55 mm			1	1										1			1													
9340.450	OM adaptor 65 A, AWG 6, W = 55 mm						1			1			1								1			1							
9340.460	OM adaptor 32 A, AWG 10, W = 55 mm		1																												
9340.260	OM support, 45 x 208 mm							1	1																	1	1				
9340.270	OM support, 55 x 272 mm									1																					
9342.860	Support rail TS45D, 35 x 10 mm	1							1																						
9342.870	Support rail TS45D-V, 35 x 10 mm					1																					1				
9340.290	Insert strip, 10 x 208 mm				2		2		3																						
9340.280	Connection pin						3	3	3																	3	3				



OM adaptors with spring terminal blocks

Switchgear assignment

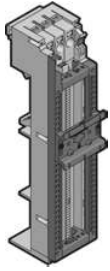

For make/model		ABB										Eaton																				
		Circuit-breaker				Starter			Reversing starter			Soft starter		Circuit-breaker				Starter			Reversing starter		Soft starter									
		MS 116/132	MS 325	MS 450/451	MS 495/496/497	MS 116 + AF09, AF12, AF16	MS 132 + AF09, AF12, AF16, AF26, AF30, AF38	MS 450 + A40, A50	MS 116 + AF09, AF12, AF16	MS 132 + AF09, AF12, AF16, AF26, AF30, AF38	MS 450 + A40, A50	MS 116 + PSR3, PSR6, PSR9, PSR12, PSR16, PSR25	MS 325 + PSR25	MS 450 + PSR30	PKZM0	PKZM01	PKZM4	PKE12	PKE32	PKE65	MSC-D + M7 - M15	MSC-D + M17 - M32	PKZM4 + DILM 17-65	MSC - DE ... M7 - M12	MSC - DE ... M17 - M32	PKE 65 + DILM 65	MSC - DE ... M7 - M12	MSC - DE ... M17 - M32	PKE 65 + DILM 65	PKE 12 + DS7-340	PKE 32 + DS7-340	PKZ0 + DS7-340
		Construction width										Construction width																				
45	54	55	70	45	45	70	90	90	140	45	45	55	45	45	55	45	45	55	45	45	55	45	45	55	90	90	110	45	45	45		
Model No.	Version	Required quantity (pieces)										Required quantity (pieces)																				
9340.530	OM adaptor 32 A, 1.5 - 6 mm ² , W = 45 mm	1				1										1	1															
9340.550	OM adaptor 32 A, 1.5 - 6 mm ² , W = 45 mm							1												1	1					1	1					
9340.560	OM adaptor 32 A, 1.5 - 6 mm ² , W = 45 mm						1		1		1	1										1	1					1	1	1		
9340.660	OM adaptor 32 A, 1.5 - 6 mm ² , W = 55 mm	1																														
9340.630	OM adaptor 65 A, 2.5 - 16 mm ² , W = 55 mm		1	1											1																	
9340.650	OM adaptor 65 A, 2.5 - 16 mm ² , W = 55 mm						1		1			1									1				1			1				
9340.260	OM support, 45 x 208 mm							1	1																1	1						
9340.270	OM support, 55 x 272 mm									1																	1					
9340.290	Insert strip, 10 x 208 mm			2			2		3																							
9340.280	Connection pin							3	3	3															3	3	3					
9340.860	Cable set AWG 12	3				3		3			3	3					3			3		3			3			3				
9340.870	Cable set AWG 10		3				3		3				3	3						3		3			3				3	3		
9340.890	Cable set AWG 6			3	3		3		3			3					3			3		3			3			3				
9342.860	Support rail TS45D, 35 x 10 mm	1																														
9342.930	Support rail TS55D, 35 x 10 mm							1																								

OM adaptors with spring terminal blocks

Switchgear assignment

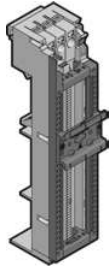

For make/model

Model No. Version		Siemens												Schneider Electric																				
		Circuit-breaker				Starter				Reversing starter				Circuit-breaker			Starter				Reversing starter		Soft starter											
		3RV10 11... (S00)	3RV10 21... (S0)	3RV10 31... (S2)	3RV20 11... (S00) screw terminal	3RV20 21... (S0) screw terminal up to 40 A	3RA11 10... (S00)	3RA11 20... (S0)	3RA11 30... (S2)	3RA21 10... (S00) screw terminal	3RA21 20... (S00/S0) screw terminal	3RA21 20... (S0) screw terminal	3RA12 10... (S00 + S00)	3RA11 20... (S0 + S0)	3RV10 31... + 3RT103... (S2 + S2)	3RA22 10... (S00) screw terminal	3RA22 20... (S0) screw terminal	GV2 - ME (screw terminal and spring terminal block)	GV2 - P	GV2 - RT, LET0, L10	GV3 BIS 65A	GV2 P + LC1D	GV2 ME + LC1D	GV2 - DM102 + LC1D/LC1K	GV2 - DP + LC1D/LC1K	GV3 + LC1D65	LUB 12	LUB 32	GV2 P + LC2D (AC)	GV2 ME + LC2D/LC2K (AC)	GV2 DM + LC2D/LC2K	GV2 DP + LC2D/LC2K	GV2 ME + ATS	
		Construction width												Construction width																				
		45	45	55	45	45	45	55	45	45	45	90	100	120	90	90	45	55	45	55	45	45	45	45	55	45	45	90	90	90	90	45		
		Required quantity (pieces)												Required quantity (pieces)																				
9340.530	OM adaptor 32 A, 1.5 - 6 mm ² , W = 45 mm	1	1	1	1												1	1																
9340.550	OM adaptor 32 A, 1.5 - 6 mm ² , W = 45 mm					1	1	1	1	1	1	1	1	1	1	1					1	1	1	1				1	1	1	1			
9340.560	OM adaptor 32 A, 1.5 - 6 mm ² , W = 45 mm																																	1
9340.630	OM adaptor 65 A, 2.5 - 16 mm ² , W = 55 mm			1														1	1															
9340.650	OM adaptor 65 A, 2.5 - 16 mm ² , W = 55 mm							1						1											1									
9340.260	OM support, 45 x 208 mm											1	1		1	1												1						
9340.270	OM support, 55 x 272 mm														1																			
9340.290	Insert strip, 10 x 208 mm												1																					
9340.280	Connection pin										3	3	3															3	3	3	3			
9340.860	Cable set AWG 12	3			3	3		3	3	3	3				3											3								
9340.870	Cable set AWG 10		3				3						3		3	3		3	3		3	3	3	3			3	3	3	3	3	3	3	
9340.880	Cable set AWG 8				3																													
9340.890	Cable set AWG 6			3				3					3				3	3						3										
9342.820	PinBlock PLUS																				1			1				1	1	1	1			

Bus-mounting fuse bases



Busbar system Page 266 **Connection adaptors** Page 270 **OM adaptors** Page 273 **Circuit-breaker component adaptors** Page 280

Material:

- Bus-mounting fuse base: Fibreglass-reinforced, thermoplastic polyester (PBT)
- Contact hazard protection: Polyamide (PA 6.6)
- Fire protection corresponding to UL 94-V0

Colour:

- RAL 7035

Note:

- For the use of fuse inserts to EN 60 269-3 (DIN VDE 0636-301)

Fuse inserts	D 02-E 18 (adaptor sleeve)	D 02-E 18 (adaptor sleeve)	D II-E 27 (adaptor screw)	D II-E 27 (adaptor screw)	D III-E 33 (adaptor screw)	D III-E 33 (adaptor screw)	Page	
Rated current max. A	63	63	25	25	63	63		
Rated operating voltage V, ~	400, 3-400 (DC)	400, 3-400 (DC)	500, 3-500 (DC)	500, 3-500 (DC)	690, 3-690 (DC)	690, 3-690 (DC)		
Number of poles	3-pole	3-pole	3-pole	3-pole	3-pole	3-pole		
Type of connection	Box terminal	Box terminal	Box terminal	Box terminal	Box terminal	Box terminal		
Connection of round conductors mm ²	1.5 - 25	1.5 - 16	1.5 - 16	1.5 - 16	1.5 - 25	1.5 - 16		
Width mm	27	41	42	56	57	71		
Height mm	209	251	209	251	209	251		
For bar systems with centre-to-centre spacing mm	60	60	60	60	60	60		
For bar thickness mm	5/10	5/10	5/10	5/10	5/10	5/10		
Model No.	3418.010	3418.040	3427.010	3427.040	3433.010	3433.040		
Packs of	10 pc(s).	5 pc(s).	10 pc(s).	5 pc(s).	10 pc(s).	5 pc(s).		
Product-specific scope of supply								
Pre-configured element ready for connection including cover plate, contact hazard protection and exterior connection clamps	-	■	-	■	-	■		
Also required								
Contact hazard protection cover plate	10 pc(s).	3418.020	-	3427.020	-	3433.020	-	321
Accessories								
Connection space extender	10 pc(s).	3418.030	-	3427.030	-	3433.030	-	321
Covers, side	10 pc(s).	3093.010	-	3093.020	-	3093.020	-	321

Bus-mounting fuse base D-Switch



Busbar system Page 266 **Connection adaptors** Page 270 **OM adaptors** Page 273 **Circuit-breaker component adaptors** Page 280

Material:

- Polyamide (PA 6)
- Fire protection corresponding to UL 94-V0

Colour:

- Chassis: RAL 7035
- Fuse holder: RAL 7001

Supply includes:

- Retaining springs for D 01 and 10 x 38 mm fuses

Basis of test:

- IEC/DIN EN 60 947-3

Note:

- For the use of fuse inserts to EN 60 269-3 (DIN VDE 0636-301)
- With integral visual fuse monitoring via flashing indicator and operating status display as well as cable routing for conductors up to 6 mm²

Fuse inserts	Packs of	D 01 (with retaining spring) D 02 (with Neozed adaptor sleeve) 10 x 38 (with retaining spring)	Page
Rated operating current max. A		63	
Rated operating voltage V, ~		400, 3~	
Number of poles		3-pole	
Voltage, indicator light V		100 - 400	
Type of connection		Box terminal	
Connection of round conductors mm ²		1.5 - 25	
Width mm		27	
Height mm		226	
For bar systems with centre-to-centre spacing mm		60	
For bar thickness mm		5/10	
Model No.	3 pc(s).	9340.950	

NH fuse-switch-disconnectors, size 000



Busbar system Page 266 **Connection adaptors** Page 270 **OM adaptors** Page 273 **Circuit-breaker component adaptors** Page 280

Material:

- Fibreglass-reinforced polyamide
- Fire protection corresponding to UL 94-V0
- Contact tracks: Silver-plated hard copper

Colour:

- Chassis: RAL 9011
- Cover: RAL 7035

Basis of test:

- IEC/DIN EN 60 947-3
- DIN EN 60 269-2 (fuse inserts)

Size 000, for mounting plate assembly

Size	Packs of	000	Page
Rated operating current max. A		100	
Rated operating voltage V, ~		690, 3~	
Number of poles		3-pole	
Cable outlet		Top/bottom	
Type of connection		Box terminal	
Connection of round conductors mm ²		1.5 - 50	
Clamping area for laminated copper bars (W x H) mm		10 x 10	
Width mm		89	
Height mm		141.5	
For mounting plate assembly		■	
Model No.	1 pc(s).	3431.000	
Accessories			
Micro-switch	5 pc(s).	3071.000	322

NH fuse-switch-disconnectors, size 000



Busbar system Page 266 **Connection adaptors** Page 270 **OM adaptors** Page 273 **Circuit-breaker component adaptors** Page 280

Material:

- Fibreglass-reinforced polyamide
- Fire protection corresponding to UL 94-V0
- Contact tracks: Silver-plated hard copper

Colour:

- Chassis: RAL 7035
- Cover: RAL 7001

Basis of test:

- IEC/DIN EN 60 947-3
- DIN EN 60 269-2 (fuse inserts)

Size 000

Size	Packs of	000	000	000	Page
Rated operating current max. A		100	100	100	
Rated operating voltage V, ~		690, 3~	690, 3~	690, 3~	
Number of poles		3-pole	3-pole	3-pole	
Cable outlet		Top	Bottom	Bottom	
Type of connection		Box terminal	Box terminal	Box terminal	
Connection of round conductors mm ²		2.5 - 50	2.5 - 50	2.5 - 50	
Width mm		53	53	53	
Height mm		213	213	213	
with electronic fuse monitoring		-	-	■	
For bar systems with centre-to-centre spacing mm		60	60	60	
For bar thickness mm		5/10	5/10	5/10	
Model No.	1 pc(s).	3431.020	3431.030	3431.035	
Accessories					
Micro-switch	5 pc(s).	3071.000	3071.000	3071.000	322

NH fuse-switch-disconnectors, size 00 to 3



Busbar system Page 266 **Connection adaptors** Page 270 **OM adaptors** Page 273 **Circuit-breaker component adaptors** Page 280

Material:

- Polyamide (PA 6)
- Fire protection corresponding to UL 94-V0
- Contact tracks: Electrolytic copper, silver-plated

Colour:

- Chassis: RAL 7035
- Cover: RAL 7035/7001

Basis of test:

- IEC/DIN EN 60 947-3
- DIN EN 60 269-2 (fuse inserts)

Note:

- The technical data may vary for UR applications. Applications to UR only in conjunction with "Special Purpose Fuses".

Size 00

Size	Packs of	00	00	00	00	Page
Rated operating current max. A		160	160	160	160	
Rated operating voltage V, ~		690, 3~	690, 3~	690, 3~	690, 3~	
Number of poles		3-pole	3-pole	3-pole	3-pole	
Cable outlet		Top/bottom	Top/bottom	Top/bottom	Top/bottom	
Type of connection		Box terminal	Screw M8	Box terminal	Screw M8	
Connection of round conductors mm ²		4 - 95	10 - 95	4 - 95	10 - 95	
Connection of sector-shaped conductors		-	-	-	-	
Clamping area for laminated copper bars (W x H) mm		13 x 13	20 x 5	13 x 13	20 x 5	
Width mm		106	106	106	106	
Height mm		194	194	194	194	
Approvals		UR	UR	UR	UR	
For mounting plate assembly		-	-	■	■	
For bar systems with centre-to-centre spacing mm		60	60	-	-	
For bar thickness mm		5/10	5/10	-	-	
Model No.	1 pc(s).	9343.000	9343.010	9344.000	9344.010	
Accessories						
Box terminal		-	-	-	-	
Connection space cover	2 pc(s).	9344.520	9344.520	9344.520	9344.520	322
Arc chambers		-	-	-	-	
Micro-switch	5 pc(s).	3071.000	3071.000	3071.000	3071.000	322
Laminated copper bars		see page	see page	see page	see page	311

NH fuse-switch-disconnectors, size 00 to 3

Size 1

Size	Packs of	1	1	1	1	Page
Rated operating current max. A		250	250	250	250	
Rated operating voltage V, ~		690, 3~	690, 3~	690, 3~	690, 3~	
Number of poles		3-pole	3-pole	3-pole	3-pole	
Cable outlet		Top/bottom	Top/bottom	Top/bottom	Top/bottom	
Type of connection		Box terminal	Screw M10	Box terminal	Screw M10	
Connection of round conductors mm ²		35 - 150	10 - 150	35 - 150	10 - 150	
Connection of sector-shaped conductors mm ²		50 - 150	-	50 - 150	-	
Clamping area for laminated copper bars (W x H) mm		20 x 3 - 14	32 x 10	20 x 3 - 14	32 x 10	
Width mm		184	184	184	184	
Height mm		298	298	298	298	
Approvals		UR	UR	UR	UR	
For mounting plate assembly		-	-	■	■	
For bar systems with centre-to-centre spacing mm		60	60	-	-	
For bar thickness mm		5/10	5/10	-	-	
Model No.	1 pc(s).	9343.100	9343.110	9344.100	9344.110	
Accessories						
Box terminal	3 pc(s).	-	9344.610	-	9344.610	322
Connection space cover	2 pc(s).	9344.530	9344.530	9344.530	9344.530	322
Arc chambers	3 pc(s).	9344.680	9344.680	9344.680	9344.680	322
Micro-switch	2 pc(s).	9344.510	9344.510	9344.510	9344.510	322
Laminated copper bars		see page	see page	see page	see page	311

Size 2 – 3

Size	Packs of	2	2	2	3	3	3	Page
Rated operating current max. A		400	400	400	630	630	630	
Rated operating voltage V, ~		690, 3~	690, 3~	690, 3~	690, 3~	690, 3~	690, 3~	
Number of poles		3-pole	3-pole	3-pole	3-pole	3-pole	3-pole	
Cable outlet		Top/bottom	Top/bottom	Top/bottom	Top/bottom	Top/bottom	Top/bottom	
Type of connection		Box terminal	Screw M10	Screw M10	Box terminal	Screw M10	Screw M10	
Connection of round conductors mm ²		95 - 300	10 - 240	10 - 240	95 - 300	10 - 300	10 - 300	
Connection of sector-shaped conductors mm ²		120 - 300	-	-	120 - 300	-	-	
Clamping area for laminated copper bars (W x H) mm		32 x 10 - 20	50 x 10	50 x 10	32 x 10 - 20	50 x 10	50 x 10	
Width mm		210	210	210	250	250	250	
Height mm		298	298	298	298	298	298	
Approvals		UR	UR	UR	UR	UR	UR	
For mounting plate assembly		-	-	■	-	-	■	
For bar systems with centre-to-centre spacing mm		60	60	-	60	60	-	
For bar thickness mm		5/10	5/10	-	5/10	5/10	-	
Model No.	1 pc(s).	9343.200	9343.210	9344.210	9343.300	9343.310	9344.310	
Accessories								
Box terminal	3 pc(s).	-	9344.620	9344.620	-	9344.620	9344.620	322
Connection space cover	2 pc(s).	9344.540	9344.540	9344.540	9344.550	9344.550	9344.550	322
Arc chambers	3 pc(s).	9344.680	9344.680	9344.680	9344.680	9344.680	9344.680	322
Micro-switch	2 pc(s).	9344.510	9344.510	9344.510	9344.510	9344.510	9344.510	322
Laminated copper bars		see page	see page	see page	see page	see page	see page	311

NH fuse-switch-disconnectors, size 00 to 3



Busbar system Page 266 **Connection adaptors** Page 270 **OM adaptors** Page 273 **Circuit-breaker component adaptors** Page 280

Material:

- Polyamide (PA 6)
- Fire protection corresponding to UL 94-V0
- Contact tracks: Electrolytic copper, silver-plated

Colour:

- Chassis: RAL 7035
- Cover: RAL 7035/7001

Basis of test:

- IEC/DIN EN 60 947-3
- DIN EN 60 269-2 (fuse inserts)

Size 00, with electronic fuse monitoring

Size	Packs of	00	00	00	00	Page
Rated operating current max. A		160	160	160	160	
Rated operating voltage V, ~		400 - 690, 3~	400 - 690, 3~	400 - 690, 3~	400 - 690, 3~	
Number of poles		3-pole	3-pole	3-pole	3-pole	
Cable outlet		Top/bottom	Top/bottom	Top/bottom	Top/bottom	
Type of connection		Box terminal	Screw M8	Box terminal	Screw M8	
Connection of round conductors mm ²		4 - 95	10 - 95	4 - 95	10 - 95	
Connection of sector-shaped conductors		-	-	-	-	
Clamping area for laminated copper bars (W x H) mm		13 x 13	20 x 5	13 x 13	20 x 5	
Width mm		106	106	106	106	
Height mm		194	194	194	194	
For mounting plate assembly		-	-	■	■	
For bar systems with centre-to-centre spacing mm		60	60	-	-	
For bar thickness mm		5/10	5/10	-	-	
Model No.	1 pc(s).	9343.020	9343.030	9344.020	9344.030	
Accessories						
Box terminal		-	-	-	-	
Connection space cover	2 pc(s).	9344.520	9344.520	9344.520	9344.520	322
Arc chambers		-	-	-	-	
Micro-switch	5 pc(s).	3071.000	3071.000	3071.000	3071.000	322
Laminated copper bars		see page	see page	see page	see page	311

NH fuse-switch-disconnectors, size 00 to 3

Size 1, with electronic fuse monitoring

Size	Packs of	1	1	1	Page
Rated operating current max. A		250	250	250	
Rated operating voltage V, ~		400 - 690, 3~	400 - 690, 3~	400 - 690, 3~	
Number of poles		3-pole	3-pole	3-pole	
Cable outlet		Top/bottom	Top/bottom	Top/bottom	
Type of connection		Box terminal	Screw M10	Screw M10	
Connection of round conductors mm ²		35 - 150	10 - 150	10 - 150	
Connection of sector-shaped conductors mm ²		50 - 150	-	-	
Clamping area for laminated copper bars (W x H) mm		20 x 3 - 14	32 x 10	32 x 10	
Width mm		184	184	184	
Height mm		298	298	298	
For mounting plate assembly		-	-	■	
For bar systems with centre-to-centre spacing mm		60	60	-	
For bar thickness mm		5/10	5/10	-	
Model No.	1 pc(s).	9343.120	9343.130	9344.130	
Accessories					
Box terminal	3 pc(s).	-	9344.610	9344.610	322
Connection space cover	2 pc(s).	9344.530	9344.530	9344.530	322
Arc chambers	3 pc(s).	9344.680	9344.680	9344.680	322
Micro-switch	2 pc(s).	9344.510	9344.510	9344.510	322
Laminated copper bars		see page	see page	see page	311

Size 2 – 3, with electronic fuse monitoring

Size	Packs of	2	2	3	3	Page
Rated operating current max. A		400	400	630	630	
Rated operating voltage V, ~		400 - 690, 3~	400 - 690, 3~	400 - 690, 3~	400 - 690, 3~	
Number of poles		3-pole	3-pole	3-pole	3-pole	
Cable outlet		Top/bottom	Top/bottom	Top/bottom	Top/bottom	
Type of connection		Screw M10	Screw M10	Screw M10	Screw M10	
Connection of round conductors mm ²		10 - 240	10 - 240	10 - 300	10 - 300	
Connection of sector-shaped conductors		-	-	-	-	
Clamping area for laminated copper bars (W x H) mm		50 x 10	50 x 10	50 x 10	50 x 10	
Width mm		210	210	250	250	
Height mm		298	298	298	298	
For mounting plate assembly		-	■	-	■	
For bar systems with centre-to-centre spacing mm		60	-	60	-	
For bar thickness mm		5/10	-	5/10	-	
Model No.	1 pc(s).	9343.230	9344.230	9343.330	9344.330	
Accessories						
Box terminal	3 pc(s).	-	-	9344.620	9344.620	322
Connection space cover	2 pc(s).	9344.540	9344.540	9344.550	9344.550	322
Arc chambers	3 pc(s).	9344.680	9344.680	9344.680	9344.680	322
Micro-switch	2 pc(s).	9344.510	9344.510	9344.510	9344.510	322
Laminated copper bars		see page	see page	see page	see page	311

NH fuse-switch-disconnectors, size 00 to 3



Busbar system Page 266 **Connection adaptors** Page 270 **OM adaptors** Page 273 **Circuit-breaker component adaptors** Page 280

Material:

- Polyamide (PA 6)
- Fire protection corresponding to UL 94-V0
- Contact tracks: Electrolytic copper, silver-plated

Colour:

- Chassis: RAL 7035
- Cover: RAL 7035/7001

Basis of test:

- IEC/DIN EN 60 947-3
- DIN EN 60 269-2 (fuse inserts)

Size 00, with electromechanical fuse monitoring

Size	Packs of	00	00	00	00	Page
Rated operating current max. A		160	160	160	160	
Rated operating voltage V, ~		690, 3~	690, 3~	690, 3~	690, 3~	
Number of poles		3-pole	3-pole	3-pole	3-pole	
Cable outlet		Top/bottom	Top/bottom	Top/bottom	Top/bottom	
Type of connection		Box terminal	Screw M8	Box terminal	Screw M8	
Connection of round conductors mm ²		4 - 95	10 - 95	4 - 95	10 - 95	
Connection of sector-shaped conductors		-	-	-	-	
Clamping area for laminated copper bars (W x H) mm		13 x 13	20 x 5	13 x 13	20 x 5	
Width mm		106	106	106	106	
Height mm		194	194	194	194	
For mounting plate assembly		-	-	■	■	
For bar systems with centre-to-centre spacing mm		60	60	-	-	
For bar thickness mm		5/10	5/10	-	-	
Model No.	1 pc(s).	9343.040	9343.050	9344.040	9344.050	
Accessories						
Box terminal		-	-	-	-	
Connection space cover	2 pc(s).	9344.520	9344.520	9344.520	9344.520	322
Arc chambers		-	-	-	-	
Micro-switch	5 pc(s).	3071.000	3071.000	3071.000	3071.000	322
Laminated copper bars		see page	see page	see page	see page	311

NH fuse-switch-disconnectors, size 00 to 3

Size 1, with electromechanical fuse monitoring

Size	Packs of	1	1	1	Page
Rated operating current max. A		250	250	250	
Rated operating voltage V, ~		690, 3~	690, 3~	690, 3~	
Number of poles		3-pole	3-pole	3-pole	
Cable outlet		Top/bottom	Top/bottom	Top/bottom	
Type of connection		Box terminal	Screw M10	Screw M10	
Connection of round conductors mm ²		35 - 150	10 - 150	10 - 150	
Connection of sector-shaped conductors mm ²		50 - 150	-	-	
Clamping area for laminated copper bars (W x H) mm		20 x 3 - 14	32 x 10	32 x 10	
Width mm		184	184	184	
Height mm		298	298	298	
For mounting plate assembly		-	-	■	
For bar systems with centre-to-centre spacing mm		60	60	-	
For bar thickness mm		5/10	5/10	-	
Model No.	1 pc(s).	9343.140	9343.150	9344.150	
Accessories					
Box terminal	3 pc(s).	-	9344.610	9344.610	322
Connection space cover	2 pc(s).	9344.530	9344.530	9344.530	322
Arc chambers	3 pc(s).	9344.680	9344.680	9344.680	322
Micro-switch	2 pc(s).	9344.510	9344.510	9344.510	322
Laminated copper bars		see page	see page	see page	311

Size 2 – 3, with electromechanical fuse monitoring

Size	Packs of	2	2	3	3	Page
Rated operating current max. A		400	400	630	630	
Rated operating voltage V, ~		690, 3~	690, 3~	690, 3~	690, 3~	
Number of poles		3-pole	3-pole	3-pole	3-pole	
Cable outlet		Top/bottom	Top/bottom	Top/bottom	Top/bottom	
Type of connection		Screw M10	Screw M10	Screw M10	Screw M10	
Connection of round conductors mm ²		10 - 240	10 - 240	10 - 300	10 - 300	
Connection of sector-shaped conductors		-	-	-	-	
Clamping area for laminated copper bars (W x H) mm		50 x 10	50 x 10	50 x 10	50 x 10	
Width mm		210	210	250	250	
Height mm		298	298	298	298	
For mounting plate assembly		-	■	-	■	
For bar systems with centre-to-centre spacing mm		60	-	60	-	
For bar thickness mm		5/10	-	5/10	-	
Model No.	1 pc(s).	9343.250	9344.250	9343.350	9344.350	
Accessories						
Box terminal	3 pc(s).	9344.620	9344.620	9344.620	9344.620	322
Connection space cover	2 pc(s).	9344.540	9344.540	9344.550	9344.550	322
Arc chambers	3 pc(s).	9344.680	9344.680	9344.680	9344.680	322
Micro-switch	2 pc(s).	9344.510	9344.510	9344.510	9344.510	322
Laminated copper bars		see page	see page	see page	see page	311

Smart monitoring system



NH fuse-switch disconnectors Page 293

Compact measurement unit consisting of measurement data acquisition unit, evaluation electronics, communication module, measurement power supply and flash data memory.

Functions:

- Continuous measurement of energy-related data
- Data logging in CSV format (Excel)
- Individual limit monitoring and alarm function
- May be integrated into the CMC III monitoring system
- Automatic address allocation via CAN bus

Material:

- Polyamide (PA 6)
- Fire protection corresponding to UL 94-V0

Colour:

- RAL 7035

Supply includes:

- NH measurement module
- Connector 2 x 2.5 mm² with preassembled bridge
- USB cable (mini-B connector on micro-B jack)

NH measurement module for NH fuse-switch disconnectors

For size	Packs of	00	1	2	3	Page
To fit Model No.		9343.000/9343.020/ 9343.040	9343.100/9343.120/ 9343.140	9343.200	9343.300	
Rated operating current max. A		150	250	400	600	
Rated operating voltage V, ~		400, 3~	400, 3~	400, 3~	400, 3~	
Number of poles		3-pole	3-pole	3-pole	3-pole	
Cable outlet		Bottom	Bottom	Bottom	Bottom	
Type of connection		Box terminal	Box terminal	Box terminal	Box terminal	
Connection of round conductors mm ²		4 - 95	35 - 150	95 - 300	95 - 300	
Connection of sector-shaped conductors mm ²		-	50 - 150	120 - 300	120 - 300	
Clamping area for laminated copper bars (W x H) mm		13 x 13	20 x 3 - 14	32 x 10 - 20	32 x 10 - 20	
Width mm		102	170	185	214	
Height mm		108	123	123	123	
Depth mm		68	92	107	107	
Precision class measurement output (voltage/current/power)		0.2 / 1.5 / 2	0.2 / 1.5 / 2	0.2 / 1.5 / 2	0.2 / 1.5 / 2	
Interfaces		2 x CAN bus (RJ45) 2 x Modbus RTU (RJ45) 1 x USB	2 x CAN bus (RJ45) 2 x Modbus RTU (RJ45) 1 x USB	2 x CAN bus (RJ45) 2 x Modbus RTU (RJ45) 1 x USB	2 x CAN bus (RJ45) 2 x Modbus RTU (RJ45) 1 x USB	
Model No.	1 pc(s).	9343.070	9343.170	9343.270	9343.370	

Smart monitoring system

Accessories



LCD display

for monitoring

Functions:

- Illuminated display with more than 50 measurement parameters
- Intuitive configuration of alarm and limit values
- Voltage supply for display via pluggable RJ12 patch cable

Material:

- Polyphenylene ether (PPE)

Colour:

- RAL 9005

Protection category IP to IEC 60 529:

- IP 51 (front)
- IP 41 (enclosure)

Supply includes:

- LCD display
- Modbus RTU cable (RJ12), length: 2 m

Interfaces	1 x Modbus RTU (RJ12)
Operating temperature range	-5°C...+55°C
Storage temperature range	-25°C...+70°C
Operating humidity range %	5 - 95
Width mm	96
Height mm	96
Depth mm	46
Packs of	1 pc(s).
Model No.	9343.410



Also required:

- Power pack, see page 300



Power pack

for LCD display

For mounting on support rails to EN 60 715, 7.5 mm high.

Material:

- Polycarbonate
- Fire protection corresponding to UL 94-V0

Colour:

- RAL 9005

Protection category IP to IEC 60 529:

- IP 20

Supply includes:

- Power pack
- Connector 2 x 2.5 mm²

Interfaces	1 x Modbus RTU (RJ12) 2 x Modbus RTU (RJ45)
Operating temperature range	-5°C...+55°C
Storage temperature range	-25°C...+70°C
Operating humidity range %	5 - 95
Width mm	71
Height mm	91
Depth mm	61
Rated operating voltage V, Hz	85 - 265 (AC/DC), 50/60
Output current (max.) A	0.42
Output voltage V (DC)	24
Packs of	1 pc(s).
Model No.	9343.400

NH slimline fuse-switch disconnectors



Busbar system Page 266 Connection adaptors Page 270 NH slimline fuse-switch disconnectors 185 mm Page 336

Material:

- Fibreglass-reinforced polyamide
- Fire protection corresponding to UL 94-V0
- Contact tracks: Silver-plated hard copper

Colour:

- Chassis: RAL 7035
- Cover: RAL 7001
- Handle: RAL 7016

Basis of test:

- IEC/DIN EN 60 947-3
- DIN EN 60 269-2 (fuse inserts)

Size 00

Size	Packs of	00	00	00	00	00	Page
Rated operating current max. A		160	160	160	160	160	
Rated operating voltage V, ~		690, 3~	690, 3~	690, 3~	690, 3~	690, 3~	
Number of poles		3-pole	3-pole	3-pole	3-pole	3-pole	
Cable outlet		Top/bottom	Top/bottom	Top/bottom	Top/bottom	Top/bottom	
Type of connection		Box terminal	Screw M8	Box terminal	Screw M8	Screw M8	
Connection of round conductors mm ²		2.5 - 95	2.5 - 95	2.5 - 95	2.5 - 95	2.5 - 95	
Width mm		50	50	50	50	50	
Height mm		400	400	400	400	400	
For converter installation		-	-	-	-	■	
For bar systems with centre-to-centre spacing mm		60	60	100	100	100	
For bar thickness mm		5/10	5/10	5/10	5/10	5/10	
Model No.	1 pc(s).	9346.000	9346.010	9346.020	9346.030	9346.060	
Product-specific scope of supply							
3 mounting hooks		■	■	■	■	-	
Accessories							
Connection space cover	1 pc(s).	9346.460	9346.460	9346.460	9346.460	9346.460	323
Clamp-type terminal connection	3 pc(s).	-	3592.010	-	3592.010	3592.010	323
Micro-switch	5 pc(s).	9346.400	9346.400	9346.400	9346.400	9346.400	322

NH slimline fuse-switch disconnectors



Busbar system Page 266 **Connection adaptors** Page 270 **NH slimline fuse-switch disconnectors 185 mm** Page 336

Material:

- Fibreglass-reinforced polyamide
- Fire protection corresponding to UL 94-V0
- Contact tracks: Silver-plated hard copper

Colour:

- Chassis: RAL 7035
- Cover: RAL 7001
- Handle: RAL 7016

Basis of test:

- IEC/DIN EN 60 947-3
- DIN EN 60 269-2 (fuse inserts)

Size 00, with electronic fuse monitoring

Size	Packs of	00	Page
Rated operating current max. A		160	
Rated operating voltage V, ~		690, 3~	
Number of poles		3-pole	
Cable outlet		Top/bottom	
Type of connection		Screw M8	
Connection of round conductors mm ²		2.5 - 95	
Width mm		50	
Height mm		400	
For bar systems with centre-to-centre spacing mm		60	
For bar thickness mm		5/10	
Model No.	1 pc(s).	9346.015	
Product-specific scope of supply			
3 mounting hooks		■	
Accessories			
Connection space cover	1 pc(s).	9346.460	323
Clamp-type terminal connection	3 pc(s).	3592.010	323
Micro-switch	5 pc(s).	9346.400	322

Fuse holders

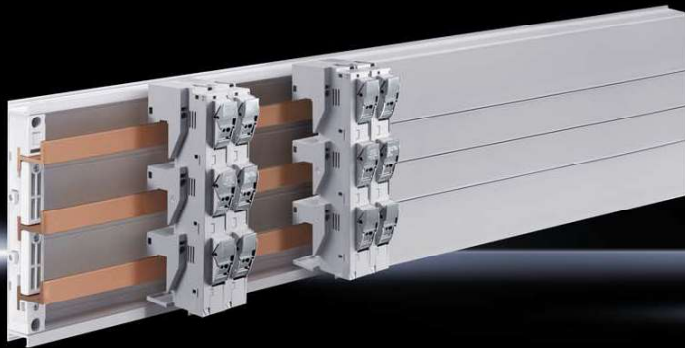

Busbar system Page 266 **Connection adaptors** Page 270 **OM adaptors** Page 273 **Circuit-breaker component adaptors** Page 280

Material:

- Polyamide (PA 6.6)
- Fire protection corresponding to UL 94-V0

Colour:

- RAL 7035

Basis of test:

- UL 4248-4

Rated operating current max. 30 A

	Packs of	CC	Page
Fuse type (class)			
Rated operating current max. A		30	
Rated operating voltage V, ~		600, 3~	
Number of poles		3-pole	
Fuse standard		UL 248-4	
Fuse size mm		10 x 38	
Connection of round conductors mm ²		1,5 - 6	
Connection of round conductors		AWG 10 - 16	
Width mm		27	
Height mm		200	
For bar systems with centre-to-centre spacing mm		60	
For bar thickness mm		5/10	
Model No.	4 pc(s).	9345.040	

Fuse holders



Busbar system Page 266 **Connection adaptors** Page 270 **OM adaptors** Page 273 **Circuit-breaker component adaptors** Page 280

Material:

- Polyamide
- Fire protection corresponding to UL 94-V0

Colour:

- RAL 7035

Note:

- For snap-on mounting on 35 mm (7.5 mm/15 mm high) support rails to DIN EN 60 715 or RiLine component adaptor combinations (OM adaptors/ supports)

Approvals:

- UL 4248-1
- UL 4248-4
- UL 4248-8

Rated operating current max. 30 – 60 A

Fuse type (class)		CC	J	J	Page
Rated operating current max. A		30	30	60	
Rated operating voltage V, ~		600, 3~	600, 3~	600, 3~	
Number of poles		3-pole	3-pole	3-pole	
Fuse standard		UL 248-4	UL 248-8	UL 248-8	
Fuse size mm		10 x 38	21 x 57	27 x 60	
Voltage, indicator light V		110 - 600	110 - 600	110 - 600	
Connection of round conductors mm ²		0.75 - 25	1.5 - 50	2.5 - 50	
Connection of round conductors		AWG 8 - 18	AWG 1 - 18	AWG 1 - 14	
Width mm		54	108	120	
Height mm		81	115	118	
Model No.		9345.005	9345.015	9345.035	
	Packs of	4 pc(s).	2 pc(s).	2 pc(s).	

Fuse holders



Busbar system Page 266 **Connection adaptors** Page 270 **OM adaptors** Page 273 **Circuit-breaker component adaptors** Page 280

Material:

- Polyamide (PA 6)
- Fire protection corresponding to UL 94-V0
- Contact tracks: Electrolytic copper, silver-plated

Colour:

- Chassis: RAL 7035
- Cover: RAL 7035/7001

Note:

- UL (listed accessory) is met when using the fuse holder on RiLine busbar systems

Standards:

- UL 508

Rated operating current max. 100 – 400 A

Fuse type (class)	Packs of	J	J	J	Page
Rated operating current min. A		61	101	201	
Rated operating current max. A		100	200	400	
Rated operating voltage V, ~		600, 3~	600, 3~	600, 3~	
Number of poles		3-pole	3-pole	3-pole	
Fuse standard		UL 4248-8	UL 4248-8	UL 4248-8	
Fuse size mm		29 x 118	41 x 146	54 x 181	
Cable outlet		Top/bottom	Top/bottom	Top/bottom	
Type of connection		Box terminal	Box terminal	Box terminal	
Connection of round conductors		AWG 2 – MCM 300	AWG 4/0 – MCM 600	AWG 4/0 – MCM 600	
Width mm		184	210	250	
Height mm		288	288	328	
Approvals		UL	UL	UL	
For bar systems with centre-to-centre spacing mm		60	60	60	
For bar thickness mm		5/10	5/10	5/10	
Model No.	1 pc(s).	9345.100	9345.200	9345.400	

RiLine accessories

Busbar supports



1



2

Busbar support

1-pole

Material:

- Polyamide (PA 6.6)
- Fire protection corresponding to UL 94-V0

Colour:

- RAL 7035

Supply includes:

9342.030

- Raised section for stepped configuration of the PLS busbars

Note:

- The busbar supports may be bayed with 60 mm bar centre distance for the configuration of multi-pole systems

Version	P. of	1	2	Page
Number of poles		1-pole	1-pole	
Bar centre distance mm		-	-	
For busbars mm		PLS 1600	-	309
		-	12 x 5/10 ¹⁾ , 15 x 5 - 30 x 10	308
Rated operating voltage V, ~		1000, 1~	1000, 1~	
		1500 (DC)	1500 (DC)	
PEN/N/PE support		■	■	
N/PE support		-	-	
Approvals		UL	UL	
Model No.	4 pc(s).	9342.030	9340.030	
Accessories				
Spacers	12 pc(s).	-	9340.090	307
Cage nuts M5 ²⁾	50 pc(s).	-	4166.000	736

¹⁾ When using busbars 12 x 5/10 mm, spacer 9340.090 is additionally required

²⁾ For attaching the busbar support to the TS frame section and punched sections with mounting flanges with rectangular system punchings 12.5 x 10.5 mm



1



2

Busbar support

2-pole

Material:

- Polyamide (PA 6.6)
- Fire protection corresponding to UL 94-V0

Colour:

- RAL 7035

Version	P. of	1	2	Page
Number of poles		2-pole	2-pole	
Bar centre distance mm		60	60	
For busbars mm		12 x 5	12 x 5 - 30 x 10	308
Rated operating voltage V, ~		1000, 2~	1000, 2~	
PEN/N/PE support		■	■	
N/PE support		■	■	
Approvals		-	UL	
Model No.	4 pc(s).	9600.005	9340.040	
Accessories				
Cage nuts M5 ¹⁾	50 pc(s).	-	4166.000	736

¹⁾ For attaching the busbar support to the TS frame section and punched sections with mounting flanges with rectangular system punchings 12.5 x 10.5 mm

RiLine accessories

Base isolators/busbars

Base isolators

For configuring busbar systems with any given bar centre distances and for assembling insulated PE or PEN busbars.

Material:

- Duroplastic polyester (UP resin)

Rated operating voltage kV	1	1
Tensile strength kN	12	13
Torsional strength Nm	75	90
Bending strength kN	6	6
Height mm	40	50
Thread	M10	M10
P. of	6 pc(s).	6 pc(s).
Model No.	3031.000	3032.000



Spacers

for RiLine busbar supports (flat busbar system)

For adapting 12 x 5 and 12 x 10 mm busbar sizes.

For busbar supports

- 9340.030 (1-pole), see page 306
- 9340.000/.010 (3-pole), see page 266
- 9340.004 (4-pole), see page 266

Material:

- Polyamide (PA 6.6)
- Fire protection corresponding to UL 94-V0

Colour:

- RAL 7035

P. of	Model No.
12 pc(s).	9340.090

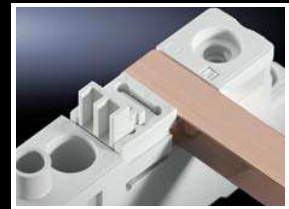

CUPONAL busbars

To DIN EN 13 601

Length: 2400 mm/bar

Copper-coated aluminium busbars, suitable for the configuration of busbar systems with busbar supports 9340.000/.050, see page 266.

Material:

- Aluminium core with crimped copper coating made from E-Cu

Dimensions mm	Rated current ¹⁾ A	P. of	Model No.
20 x 5	235	6 pc(s).	3582.020
20 x 10	363	3 pc(s).	3585.020
30 x 5	328	6 pc(s).	3584.020
30 x 10	493	3 pc(s).	3586.020

¹⁾ Current carrying capacity at 65°C bar temperature and 35°C ambient temperature, correction factor diagram to DIN 43 671

Short-circuit resistance diagram

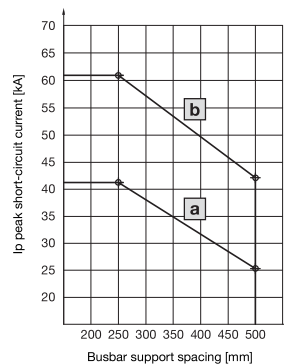

CUPONAL busbars mm	Busbar supports	Curve
20 x 5/10	9340.000/.050	a
30 x 5/10	9340.000/.050	b



RiLine accessories

Busbars

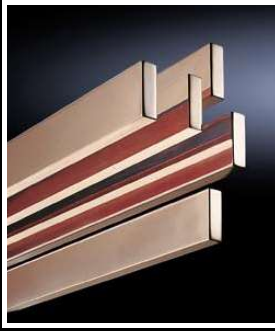

E-Cu busbars

To DIN EN 13 601

Length: 2400 mm/bar

Material:
E-Cu F30

Dimensions mm	Approvals	P. of	Model No.	Page
12 x 5	UL	6 pc(s).	3580.000	
15 x 5	UL	6 pc(s).	3581.000	
20 x 5	UL	6 pc(s).	3582.000	
25 x 5	UL	6 pc(s).	3583.000	
30 x 5	UL	6 pc(s).	3584.000	
12 x 10	UL	6 pc(s).	3580.100	
15 x 10	UL	6 pc(s).	3581.100	
20 x 10	UL	3 pc(s).	3585.005	
30 x 10	UL	3 pc(s).	3586.005	
40 x 10	-	3 pc(s).	3587.000	
50 x 10	-	2 pc(s).	3588.005	
60 x 10	-	2 pc(s).	3589.005	
80 x 10	-	1 pc(s).	3590.005	
100 x 10	-	1 pc(s).	3590.015	
120 x 10	-	1 pc(s).	3590.020	

Accessories

Busbar connectors for busbars mm	12 x 5 – 15 x 10 (single connection)	3 pc(s).	9350.075	309
	20 x 5 – 30 x 10 (single connection)	3 pc(s).	9320.020	309
	20 x 5 – 30 x 10 (bayed connection)	3 pc(s).	9320.030	309
Busbar cover sections for busbars mm	12/15 x 5	4 pc(s).	9350.010	308
	12/15 x 10	4 pc(s).	9350.060	308
	12 x 5 – 30 x 10	10 pc(s).	3092.000	308
	40 - 60 x 10	10 pc(s).	3085.000	308
Inserted screw nuts		30 pc(s).	3591.060	767



Busbar cover sections

Contact hazard protection by covering the busbars.
May be cut to required length.

Length: 1000 mm/section

Material:

- Thermally modified hard PVC
- Fire protection corresponding to UL 94-V0

Colour:

- RAL 7035

Note:

- Contact hazard protection,
for more solutions see page 312.

For busbars mm	Approvals	P. of	Model No.
12/15 x 5	-	4 pc(s).	9350.010
12/15 x 10	-	4 pc(s).	9350.060
12 x 5 – 30 x 10	UR	10 pc(s).	3092.000
40 - 60 x 10	UR	10 pc(s).	3085.000

RiLine accessories

Busbars

PLS special busbars E-Cu

For system PLS 800, bar thickness 5 mm, bar cross-section 300 mm²

For enclosure width mm	Length mm	Approvals	P. of	Model No.	Page
600	495	UL	3 pc(s).	3524.000	
800	695	UL	3 pc(s).	3525.000	
1000	895	UL	3 pc(s).	3525.010	
1200	1095	UL	3 pc(s).	3526.000	
variable	2400	UL	1 pc(s).	3509.000	

Accessories

PLS busbar connector (single connection)	3 pc(s).	3504.000	310
PLS busbar connector (bayed connection)	3 pc(s).	3505.000	310
PLS expansion connector	3 pc(s).	9320.060	310

For system PLS 1600, bar thickness 10 mm, bar cross-section 900 mm²

For enclosure width mm	Length mm	Approvals	P. of	Model No.	Page
600	495	UL	3 pc(s).	3527.000	
800	695	UL	3 pc(s).	3528.000	
1000	895	UL	3 pc(s).	3528.010	
1200	1095	UL	3 pc(s).	3529.000	
variable	2400	UL	1 pc(s).	3516.000	

Accessories

PLS busbar connector (single connection)	3 pc(s).	3514.000	310
PLS busbar connector (bayed connection)	3 pc(s).	3515.000	310
PLS expansion connector	3 pc(s).	9320.070	310



Busbar connectors

For connecting rectangular busbars, no drilling required.

Material: 9350.075

- Top piece: St 37, nickel-plated surface finish
- Contact plate: E-Cu, nickel-plated surface finish

9320.020/9320.030

- Top piece: Sheet steel, zinc-plated, passivated
- Contact plate: E-Cu, silver-plated

For busbars mm	Application		Approvals	P. of	Model No.
	Single connection	Bayed connection ¹⁾			
12 x 5 – 15 x 10	■	–	UL	3 pc(s).	9350.075
20 x 5 – 30 x 10	■	–	UL	3 pc(s).	9320.020
	–	■	UL	3 pc(s).	9320.030

¹⁾ Connection from enclosure to enclosure



RiLine accessories

Busbars

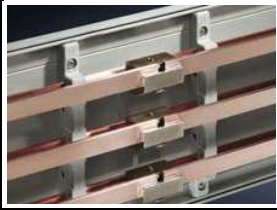

PLS busbar connectors

For connecting PLS special busbars; no drilling required.

Material:

- E-Cu

Surface finish:

- Nickel-plated

Application	For system	Approvals	P. of	Model No.
Single connection	PLS 800	UL	3 pc(s).	3504.000
	PLS 1600	UL	3 pc(s).	3514.000
Bayed connection ¹⁾	PLS 800	UL	3 pc(s).	3505.000
	PLS 1600	UL	3 pc(s).	3515.000

¹⁾ Connection from enclosure to enclosure

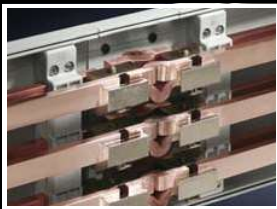

PLS expansion connector

For thermal and mechanical compensation when connecting PLS special busbars from enclosure to enclosure.

Material:

- E-Cu

Note:

- At a temperature increase of 30 K, busbars expand by approximately 0.5 mm/m in the length. For this reason, it is advisable to use an expanding connection for thermal compensation in busbar systems with busbar sections > 3600 mm.

Expansion connector	For system	Approvals	P. of	Model No.	Page
	PLS 800	UR	3 pc(s).	9320.060	
	PLS 1600	UR	3 pc(s).	9320.070	

Also required

PLS busbar connectors ¹⁾	For system	Approvals	P. of	Model No.	Page
	PLS 800	UL	3 pc(s).	3504.000	310
	PLS 1600	UL	3 pc(s).	3514.000	310

¹⁾ Two busbar connectors are needed to fit one expansion connector.

RiLine accessories

Laminated copper bars

Laminated copper bars

Length: 2000 mm/bar

Material:

Cu membranes

- High-purity electrolyte copper F20

Insulation

- High-strength vinyl compound
- Expansion 370%
- Temperature range: -30°C...+105°C
- Fire protection corresponding to UL 94-V0
- Dielectric strength: 20 kV/mm

Configuration ¹⁾ mm	I _n at 70 K ²⁾ A	I _n at 50 K ²⁾ A	I _n at 30 K ²⁾ A	P. of	Model No.
6 x 9 x 0.8	285	240	180	1 pc(s).	3565.005
6 x 15.5 x 0.8	415	350	265	1 pc(s).	3568.005
10 x 15.5 x 0.8	575	480	365	1 pc(s).	3569.005
5 x 20 x 1	525	435	330	1 pc(s).	3570.005
5 x 24 x 1	605	510	385	1 pc(s).	3571.005
10 x 24 x 1	920	770	585	1 pc(s).	3572.005
5 x 32 x 1	770	645	485	1 pc(s).	3573.005
10 x 32 x 1	1155	965	730	1 pc(s).	3574.005
5 x 40 x 1	930	780	590	1 pc(s).	3575.005
10 x 40 x 1	1370	1145	865	1 pc(s).	3576.005
5 x 50 x 1	1125	940	710	1 pc(s).	3577.005
10 x 50 x 1	1635	1365	1030	1 pc(s).	3578.005
10 x 63 x 1	1950	1610	1230	1 pc(s).	3579.005

¹⁾ Number of membranes x membrane width x membrane thickness

²⁾ The conductor temperature of the laminated copper bar is derived by adding the ambient temperature and the temperature increase together

Example:

3565.005 carrying 180 A, i.e. the temperature increases by 30 K. At an ambient temperature of 35°C, this produces a resultant conductor temperature of 35°C + 30 K = 65°C.



Universal support

For the attachment of laminated copper bars from 5 x 20 x 1 mm to 10 x 63 x 1 mm.

Material:

- Fibreglass-reinforced, thermoplastic polyester (PBT)
- Fire protection corresponding to UL 94-V0

Colour:

- RAL 7035

Supply includes:

- Screws and sliding nuts for mounting on PS punched rails

P. of	Model No.
3 pc(s).	3079.000



Accessories:

- PS punched rails, see page 721



Universal support

For the attachment of multi-packetised laminated copper bars from 5 x 40 x 1 mm to 10 x 100 x 1 mm.

Material:

- Fibreglass-reinforced, thermoplastic polyester (PBT)
- Fire protection corresponding to UL 94-V0

Colour:

- RAL 7035

Supply includes:

- Screws and sliding nuts for mounting on C rails

P. of	Model No.
1 pc(s).	3079.010

Note:

- 1 universal support corresponds to the supply scope shown in the photograph



Accessories:

- C rails 30/15, see page 723



RiLine accessories

Contact hazard protection



System components

Material:

- Thermally modified hard PVC
- Fire protection corresponding to UL 94-V0

Colour:

- RAL 7035

For RiLine busbar system	3-pole			4-pole	
	Flat bars	PLS 800	PLS 1600	Flat bars	PLS 1600 PLUS

[1] Base trays							
Length (L) mm	P. of	Approvals	Model No.			Model No.	
500	2 pc(s).	UL	9340.100	9341.100	9342.100	-	-
700	2 pc(s).	UL	9340.110	9341.110	9342.110	-	-
900	2 pc(s).	UL	9340.120	9341.120	9342.120	-	-
1100	2 pc(s).	UL	9340.130	9341.130	9342.130	9340.134	9342.134
2400	1 pc(s).	UL	9340.170	9341.170	9342.170	-	-

[1] Base tray infills							
100	2 pc(s).	UL	9340.140	9341.140	9342.140	-	-

[2] Cover sections							
700	2 pc(s).	UL	9340.200	9340.200	9340.200	-	-
1100	2 pc(s).	UL	9340.210	9340.210	9340.210	9340.214	9340.214

[1] Base tray	[1] Base tray infill	[2] Cover section
For rear contact hazard protection of the flat bar assembly.	For rear contact hazard protection when connecting the busbars from enclosure to enclosure. Supply includes: Assembly parts	May be cut to required length; for clip-on mounting onto the base tray. Note: If the cover section is loaded from the front, the support panel is needed for stability.

Support panels

for cover section

To prevent side access to the cover section. The support panel also provides additional stability.

Recommended mounting distance: ≤ 500 mm

Material:

- Polyamide (PA 6.6)
- Fire protection corresponding to UL 94-V0

Colour:

- RAL 7035

For system configuration	Approvals	P. of	Model No.
3-pole	UL	5 pc(s).	9340.220
4-pole	UL	5 pc(s).	9340.224

Cross members

for RiLine busbar connections, 3-pole

To comply with the clearances required for "feeder circuits" under UL 508. For flat bar systems with 60 mm bar centre distance and PLS 800/1600.

Material:

- Polyamide (PA 6.6)
- Fire protection corresponding to UL 94-V0

Colour:

- RAL 7035

Note:

- Two cross members are required for one busbar connection

Length mm	Approvals	P. of	Model No.
160	UL	2 pc(s).	9340.230

[!] Also required:

- Support panel 9340.220, see page 312

RiLine accessories

Connection systems

Conductor connection clamps

Push-in

Applications:

- For use as busbar pick-off of L, N or PE conductors in switchgear and controlgear, and as a conductor connection clamp in meter boxes.
- For mounting on E-Cu or CUPONAL busbars.

Benefits:

- maintenance-free
- Time-saving top-mounting
- Terminal box with integral label panels
- Universal conductor connection

Functions:

- Fully insulated terminal for tool-free conductor connection
- Conductor is released by the integral release pin

Material:

- Polyamide (PA 6.6)
- Fire protection corresponding to UL 94-V0

Colour:

- RAL 7042

Basis of test:

- IEC 60 999-1
- IEC 60 947-7-1/-2



For bar thickness mm	Connection of round conductors, single-wire mm ²	Connection of round conductors, multi-wire mm ²	Connection of round conductors, fine wire without wire end ferrule mm ²	Connection of round conductors, fine wire with wire end ferrule mm ²	Packs of	Model No.
5	0.5 - 6	0.5 - 4	0.5 - 4	0.5 - 4	10 pc(s).	3450.505
5	1.5 - 16	1.5 - 16	1.5 - 16	1.5 - 16	10 pc(s).	3451.505
10	0.5 - 6	0.5 - 4	0.5 - 4	0.5 - 4	10 pc(s).	3455.505
10	1.5 - 16	1.5 - 16	1.5 - 16	1.5 - 16	10 pc(s).	3456.505

Conductor connection clamps

For connecting round conductors and laminated copper bars.

Note:

- Wire end ferrules should be used with fine wire conductors.

Approvals:

- UR



Accessories:

- Laminated copper bars, see page 311

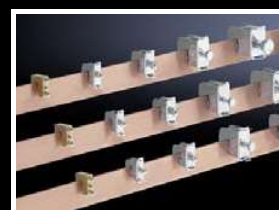

For bar thickness mm	Clamping area for laminated copper bars (W x H) mm	Connection of round conductors mm ²	Material	Surface finish	Packs of	Model No.
5	–	1 - 4	Sheet steel	Zinc-plated, passivated	15 pc(s).	3450.500
5	8 x 8	2.5 - 16	Sheet steel	Zinc-plated, passivated	15 pc(s).	3451.500
5	10.5 x 11	16 - 50	Sheet steel	Zinc-plated, passivated	15 pc(s).	3452.500
5	16.5 x 15	35 - 70	Sheet steel	Zinc-plated, passivated	15 pc(s).	3453.500
5	22.5 x 20	70 - 185	Sheet steel	Zinc-plated, passivated	15 pc(s).	3454.500
10	–	1 - 4	Sheet steel	Zinc-plated, passivated	15 pc(s).	3455.500
10	8 x 8	2.5 - 16	Sheet steel	Zinc-plated, passivated	15 pc(s).	3456.500
10	10.5 x 11	16 - 50	Sheet steel	Zinc-plated, passivated	15 pc(s).	3457.500
10	16.5 x 15	35 - 70	Sheet steel	Zinc-plated, passivated	15 pc(s).	3458.500
10	22.5 x 20	70 - 185	Sheet steel	Zinc-plated, passivated	15 pc(s).	3459.500
3 - 5	–	1 - 4	Brass	–	15 pc(s).	3550.000
6 - 10	–	1 - 4	Brass	–	15 pc(s).	3555.000

RiLine accessories

Connection systems



Plate clamps

For connecting laminated copper bars; no drilling required.

Material:

- Sheet steel

Surface finish:

- Zinc-plated, passivated

For busbars mm	Clamping area for laminated copper bars (W x H) mm	Packs of	Model No.
12 x 5 - 30 x 10	34 x 10	3 pc(s).	3554.000
40 x 10	34 x 10	3 pc(s).	3559.000
50 x 10	34 x 10	3 pc(s).	3560.000
50 x 10	54 x 10	3 pc(s).	3562.000
60 x 10	34 x 10	3 pc(s).	3561.000
60 x 10	54 x 10	3 pc(s).	3563.000
80 x 10	65 x 10	3 pc(s).	3460.500



Accessories:

- Laminated copper bars, see page 311



System covers

For conductor connection clamps and plate clamps.

Material:

- ABS
- Fire protection corresponding to UL 94-V0

Colour:

- RAL 7035

Note:

- For 3-pole systems with 60/100 mm bar centre distance
- Only suitable for use with systems without a base tray
- For systems with a base tray, the system covers must be mechanically shortened

Approvals:

- UR

Width mm	Depth mm	Height when mounting on busbar systems 60 mm mm	Height when mounting on busbar systems 100 mm mm	Packs of	Model No.
50	80	230	325	4 pc(s).	3086.000
100	80	230	325	4 pc(s).	3087.000
100	110	230	325	4 pc(s).	3090.000
200	80	230	325	4 pc(s).	3088.000
200	110	230	325	4 pc(s).	3091.000

Connection block

For connecting round conductors and laminated copper bars. Suitable for busbars 12 x 5 to 30 x 10 mm and PLS 800/1600.

Material:

- Chassis: Polyamide (PA 6.6).
- Cover: ABS
- Fire protection corresponding to UL 94-V0

Colour:

- RAL 7035

Supply includes:

- 3 terminals including cover.

Note:

- When using the terminal on 2-pole busbar systems (SV 9340.040), the terminal must be rotated through 180° for connection to the PE busbar.

Approvals:

- UL



Accessories:

- Laminated copper bars, see page 311



Rated current (max.) A	800	1600
Rated operating voltage V, ~	690, 1~	690, 1~
Rated operating voltage (L1 + L2) V	1000 (DC)	1000 (DC)
Rated operating voltage (L1 + L3) V	1500 (DC)	1500 (DC)
Cable outlet	Top/bottom	Top/bottom
Connection of round conductors, fine wire with wire end ferrule mm ²	95 - 185	-
Connection of round conductors, multi-wire mm ²	95 - 300	-
Clamping area for laminated copper bars with 5 mm bar thickness (W x H) mm	33 x 26	65 x 27
Clamping area for laminated copper bars with 10 mm bar thickness (W x H) mm	33 x 22	65 x 22
Width mm	50	85
Height mm	88	88
Packs of	3 pc(s).	3 pc(s).
Model No.	9342.311	9342.321

RiLine accessories

Mini-PLS component adaptor



Insert strip

for Mini-PLS component adaptors
To extend the construction width.

Material:

- ABS

Colour:

- RAL 7035

Approvals:

- UR

Width mm	Packs of	Model No.
9	2 pc(s).	9623.000



Support rails 35 x 7.5 mm

for Mini-PLS component adaptors

Material:

- Sheet steel

Surface finish:

- Zinc-plated

Supply includes:

- Assembly screws and side anti-slip guard

Width mm	Packs of	Model No.
45	10 pc(s).	9320.150
54	10 pc(s).	3548.000

RiLine accessories

for OM adaptor/support

Support rails 35 x 10 mm

for OM adaptor/support

For attaching to the adaptor section and support frame.

Material:

- Polyamide (PA 6.6)

Colour:

- RAL 9005

Supply includes:

- Assembly screws

Note:

- UL approval in conjunction with OM adaptor/support
- Support rail TS xxD-V only suitable for non-pitch pattern-dependent mounting on support frame

Width mm	With anti-slip guard for motor circuit-breaker	Design	Packs of	Model No.
45	■	TS 45C	5 pc(s).	9342.850
45	–	TS 45D	5 pc(s).	9342.860
45	–	TS 45D-V	5 pc(s).	9342.870
55	■	TS 55C	5 pc(s).	9342.920
55	–	TS 55D	5 pc(s).	9342.930
55	–	TS 55D-V	5 pc(s).	9342.940



Support rails 35 x 15 mm

for OM adaptor/support

For attaching to the adaptor section.

Material:

- Sheet steel

Surface finish:

- Zinc-plated

Supply includes:

- Assembly screws and side anti-slip guard

Width mm	Packs of	Model No.
45	5 pc(s).	9342.880
55	5 pc(s).	9342.950



Support rails 35 x 7.5 mm

for OM adaptor/support

Applications:

- For assembly on 55 mm wide OM adaptors/supports with 10 mm wide insert strips mounted on the right and left.
- Arrangement of the mounting hole for central configuration on 55 mm wide adaptor section or support frame.

Material:

- Sheet steel

Surface finish:

- Zinc-plated

Supply includes:

- Assembly screws and side anti-slip guard

Width mm	Packs of	Model No.
72	5 pc(s).	9342.980



RiLine accessories

for OM adaptor/support



Insert strip

for OM adaptor/support

To extend the construction width in a 10 mm pitch pattern. May be bayed as often as required on both sides. With integral cable duct.

Material:

– Polyamide (PA 6.6)

Colour:

– RAL 7035

Supply includes:

– 6 connection pins

Approvals:

– UL

Width mm	Packs of	Model No.
10	2 pc(s).	9340.290



Connection pin

for OM adaptor/support

For any required mechanical connection of OM adaptor/support and insert strip 9340.290.

Material:

– Polyamide (PA 6)

Colour:

– RAL 5010

Approvals:

– UL

Packs of	Model No.
20 pc(s).	9340.280



PinBlock

for support frames

For reliable attachment and positioning of the contactor on motor starter combinations. Simple clip-on mounting onto the support frame. Individual vertical positioning is achieved by relocating the PinBlock.

Material:

– Polyamide (PA 6.6)

Colour:

– RAL 9005

Note:

– UL approval in conjunction with OM adaptor/support

For support frame width mm	Packs of	Model No.
45	5 pc(s).	9342.800
55	5 pc(s).	9342.810

**Accessories:**

– PinBlock Plus, see page 318



PinBlock Plus

for starters with increased contactor attachment

Mounted by simply clipping onto the PinBlock 9342.800/.810.

Material:

– Polyamide (PA 6.6)

Colour:

– RAL 9005

Note:

– UL approval in conjunction with OM adaptor/support

Packs of	Model No.
5 pc(s).	9342.820

RiLine accessories

for OM adaptor/support

Cable set

for OM adaptors with tension spring clamp

Pre-assembled connection cables for individual connection of switchgear, top-mounted on OM adaptors with tension spring clamps.

Material:

- PVC insulation
- Temperature resistant to 105°C
- Wire ends with ultrasonic wire-end compression at both ends

Note:

- AWG = American Wire Gauge

Cross-section	Length mm	Packs of	Model No.
AWG 14 = 2.08 mm ² ± 2.5 mm ²	140	15 pc(s).	9340.850
AWG 12 = 3.31 mm ² ± 4 mm ²	140	15 pc(s).	9340.860
AWG 10 = 5.26 mm ² ± 6 mm ²	140	15 pc(s).	9340.870
AWG 8 = 8.37 mm ² ± 10 mm ²	140	6 pc(s).	9340.880
AWG 6 = 13.3 mm ² ± 16 mm ²	140	6 pc(s).	9340.890



Twin cords

for OM adaptors with tension spring clamp

2.5 – 16 mm²

Pre-assembled connection cables for individual connection of up to two switchgear units per adaptor.

Material:

- PVC insulation
- Temperature resistant to 105°C
- Wire ends with ultrasonic wire-end compression at both ends

Note:

- AWG = American Wire Gauge

Cross-section	Length mm	Packs of	Model No.
AWG 10 = 5.26 mm ² ± 6 mm ²	140 250	6 pc(s).	9340.820
AWG 8 = 8.37 mm ² ± 10 mm ²	140 250	6 pc(s).	9340.830



RiLine accessories

for circuit-breaker component adaptors

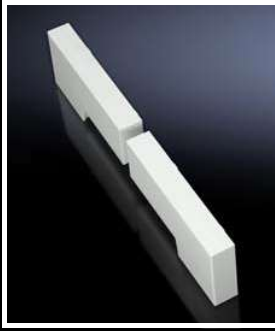

Insert strip

for circuit-breaker component adaptors

To extend the construction width from 140 mm to 190 mm.

Material:

– ABS

Colour:

– RAL 7035

Supply includes:

– Including connection parts for power circuit-breaker, brand Siemens VL630 (3-pole)

Note:

– 4 pieces are needed to widen a component adaptor

Approvals:

– UL

Width mm	To fit Model No.	Packs of	Model No.
25	9345.700/ 9345.710/ 9345.720/ 9345.730	4 pc(s).	9342.720



Sliding blocks

for circuit-breaker component adaptors

For additional locking of circuit-breakers with more than two attachment points.

Colour:

– RAL 7035

Note:

– UL approval in conjunction with circuit-breaker component adaptor

To fit Model No.	With threaded insert	Packs of	Model No.
9342.500/.510/ 9342.504/.514/ 9342.540/.550	M3 M4	6 pc(s).	9342.560
9345.600/.610/ 9345.604/.614	M4 M5	6 pc(s).	9342.640

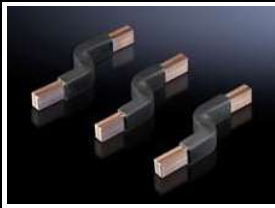

Connection bracket

for circuit-breaker component adaptors

Pre-assembled, laminated flat copper for connecting standard, commercially available moulded case circuit-breakers (MCCB).

Material:

– Electrolytic copper F20

Note:

– Universal application for switchgear with a dimensional difference between the mounting level and the upper edge of the contact level of 20 ± 5 mm.

For switchgear make (model)	To fit Model No.	Number of lamina	Membrane width mm	Membrane thickness mm	Packs of	Model No.
ABB (T1, T1 UL, T2, T2 UL) Eaton (NZM1, NZM1 UL, BZM B1) Schneider Electric (NSC100, NSE75, NSE100)	9342.500/ 9342.510/ 9342.540/ 9342.550	6	9	0.8	3 pc(s).	9342.570



Support rails 35 x 15 mm

for Mini-PLS/circuit-breaker component adaptors

Material:

– Sheet steel

Surface finish:

– Zinc-plated

Supply includes:

– Assembly screws and side anti-slip guard

Approvals:

– UR

Width mm	To fit Model No.	Packs of	Model No.
72	9342.400/ 9342.410/ 9629.000	5 pc(s).	9320.120

RiLine accessories

for bus-mounting fuse bases

Contact hazard protection cover plate

for bus-mounting fuse bases

The cover ensures contact hazard protection from the front, top and below. All-round contact hazard protection (up to IP 2X) in conjunction with the side cover 3093.010/.020.

Material:

- Polyamide (PA 6.6)
- Fire protection corresponding to UL 94-V0

Colour:

- RAL 7035

To fit Model No.	Fuse inserts	Packs of	Model No.
3418.010	D 02-E 18	10 pc(s).	3418.020
3427.010	D II-E 27	10 pc(s).	3427.020
3433.010	D III-E 33	10 pc(s).	3433.020



Covers, side

for bus-mounting fuse bases

For clip-on mounting onto the cover plate, contact hazard protection.

Material:

- Polyamide (PA 6.6)
- Fire protection corresponding to UL 94-V0

Colour:

- RAL 7035

To fit Model No.	Fuse inserts	Packs of	Model No.
3418.010	D 02-E 18	10 pc(s).	3093.010
3427.010/ 3433.010	D II-E 27 D III-E 33	10 pc(s).	3093.020



Connection space extender

for bus-mounting fuse bases

Contact hazard protection cover plate including cable duct for side extension of the connection space by 14 mm.

Material:

- Polyamide (PA 6.6)
- Fire protection corresponding to UL 94-V0

Colour:

- RAL 7035

To fit Model No.	Fuse inserts	Packs of	Model No.
3418.010	D 02-E 18	10 pc(s).	3418.030
3427.010	D II-E 27	10 pc(s).	3427.030
3433.010	D III-E 33	10 pc(s).	3433.030



RiLine accessories

for NH fuse-switch disconn./NH slimline fuse-switch disconn.



Box terminal

for NH fuse-switch disconnectors

For direct connection of round and sector-shaped conductors and laminated copper bars. Suitable for NH fuse-switch disconnectors with screw terminal.

Material:

- Cast brass

Surface finish:

- Nickel-plated

For size	Clamping area for laminated copper bars (W x H) mm	Connection of round conductors mm ²	Connection of sector-shaped conductors mm ²	Packs of	Model No.
1	20 x 14	35 - 150	50 - 150	3 pc(s).	9344.610
2/3	32 x 20	95 - 300	120 - 300	3 pc(s).	9344.620

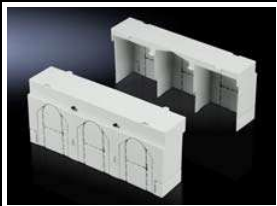

Connection space cover

for NH fuse-switch disconnectors

For extending the contact hazard protection cover, e.g. when using ring terminals with a long collar. Bayable as required at the top and bottom.

Material:

- Polyamide (PA 6)

Colour:

- RAL 7035

For size	Packs of	Model No.
00	2 pc(s).	9344.520
1	2 pc(s).	9344.530
2	2 pc(s).	9344.540
3	2 pc(s).	9344.550



Arc chambers

for NH fuse-switch disconnectors

To increase switching capacity (utilisation category).

For size	Packs of	Model No.
1 - 3	3 pc(s).	9344.680



Micro-switch

for NH fuse-switch disconnectors

To indicate the switch position of the NH unit (cover).

For size	Note on Model No.	Packs of	Model No.
000 00	-	5 pc(s).	3071.000
1 - 3	Including plastic lug for attaching the micro-switch to the isolator chassis	2 pc(s).	9344.510



Micro-switch

for NH slimline fuse-switch disconnectors

To indicate the switch position of the NH unit (cover).

For size	Packs of	Model No.
00	5 pc(s).	9346.400

RiLine accessories

for NH slimline fuse-switch disconnectors

Connection space cover

for NH slimline fuse-switch disconnectors

Extended version for the use of ring terminals with a long collar.

Material:

- Polycarbonate

For size	Packs of	Model No.
00	1 pc(s).	9346.460



Clamp-type terminal connection

for NH slimline fuse-switch disconnectors

For the connection of round conductors. Suitable for NH slimline fuse-switch disconnectors with screw terminal.

Material:

- Cast brass

Surface finish:

- Nickel-plated

For size	Connection of round conductors mm ²	Packs of	Model No.
00	1.5 - 95	3 pc(s).	3592.010



Ri4Power system 185 mm – System assembly without drilling

The busbar system is quickly and conveniently installed in the enclosure in just three steps:

- Position the TS punched section with mounting flange and system attachment in the enclosure
- Secure the busbar assembly
- Clip the cover system into position

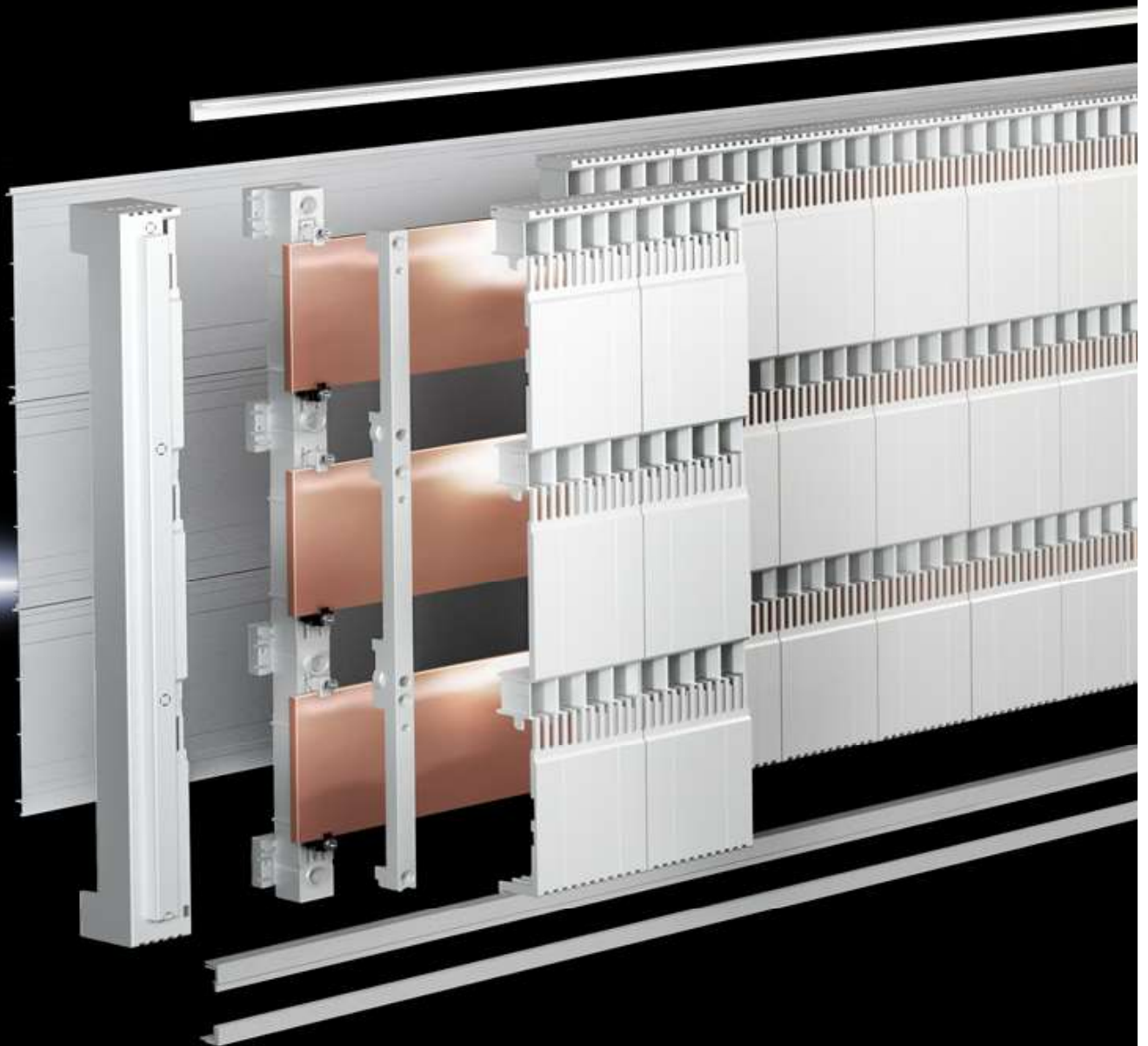

Busbar supports

- For busbar dimensions ranging from 40 x 10 to 120 x 10 mm
- The support may be top-mounted with components using the pitch pattern of the cover system
- Rated short-time withstand current I_{sw} up to 50 kA
- Rated busbar currents of up to 2100 A
- Mounting via system attachment in the TS/SE enclosure, no drilling required



Cover section

- Contact hazard protection up to IP 2XB (safe from finger-contact)
- Integral busbar shielding to prevent accidental arcing
- Secure positioning of the top-mounting components, thanks to centring device
- New contact system allows components to be top-mounted on the cover section
- Components are easily retrofitted without removing the cover section

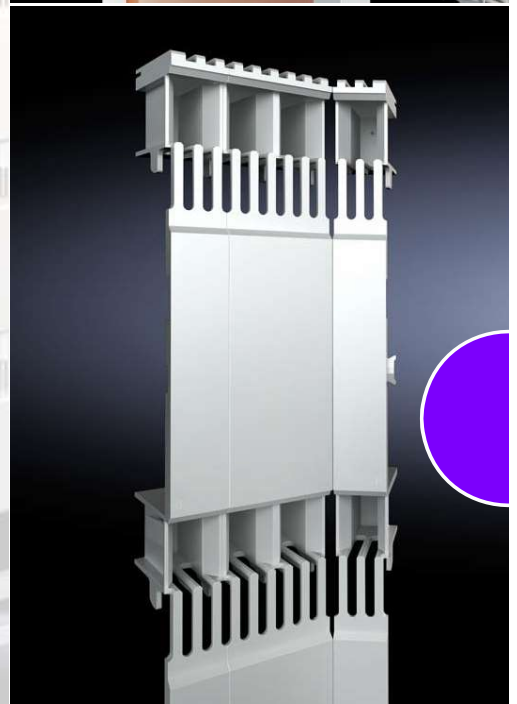

Base tray

- For rear contact hazard protection of the busbar assembly
- For optimum all-round contact hazard protection in conjunction with the cover section
- Prepared ready to install, fits TS enclosure widths from 600 mm to 1200 mm



The perfect-fit adaptor system

Connection and component adaptors for tested, safe connection at high currents

- For air circuit-breakers up to 630 A and 1600 A
- Direction connection of various conductor types
- No-drill connection system to the busbar



Busbar connection adaptors and connection blocks

- Compact, fast connection of cables and lines
- Suitable for various types of conductor
- With standardised contact hazard protection cover plates



Component adaptors for compact air circuit-breakers

- Two sizes up to 630 A and 1600 A
- Variants for clamping or screw attachment
- Make contact without drilling
- Ideal for incoming and outgoing circuits



Connector kit and transformer

- Form-fit, prepared for switch brands ABB, Eaton, Schneider Electric, Siemens
- Preassembled connector kits from the adaptor to the air circuit-breaker
- Optional integration of a current transformer
- Complete contact hazard protection in the inlet and outlet zones



Fuse elements to suit all situations

The new system of NH slimline fuse-switch disconnectors is based on separate air routing for heat dissipation and targeted removal of switching gases, while the NH slimline switch-disconnectors ensure user-independent disconnection and switching for enhanced safety.

- Simple device assembly
- Safe operation
- Optimum contact hazard protection

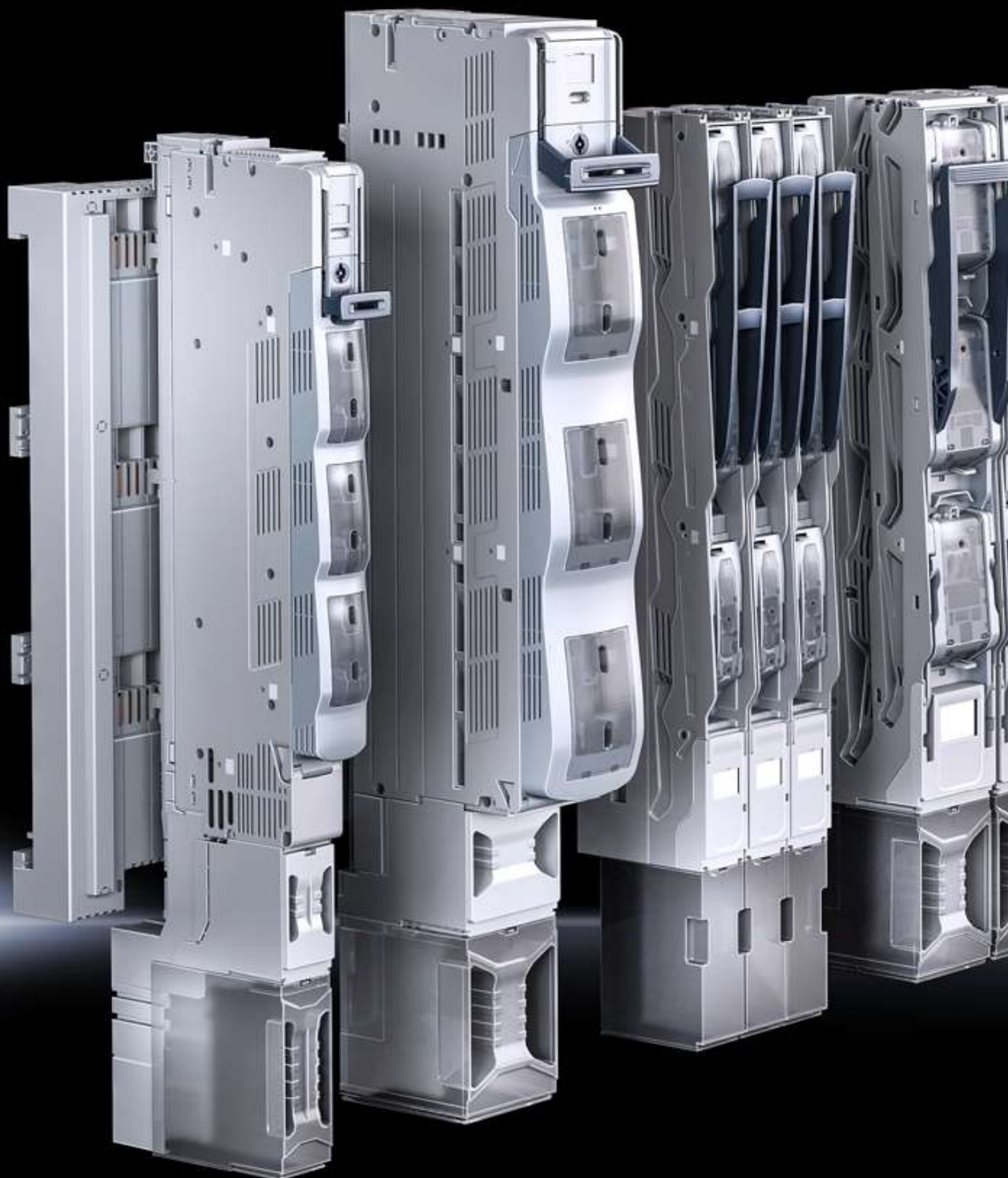

NH slimline fuse-switch disconnectors, sizes 00 to 3

- 1-pole and 3-pole switchable variants
- Symmetrical layout for cable outlet at the top and bottom
- Optional integration of current transformers
- Versions with and without fuse monitoring.
- Self-closing voltage testing holes
- Prepared for multiple lead seals
- Hinged terminal cover
- Cascadable connection space extension
- Simple conversion of the bolt or screw connections
- Contact hazard-proof fuse contacts with the top section dismantled
- Optional micro-switch monitoring of the cover switch position

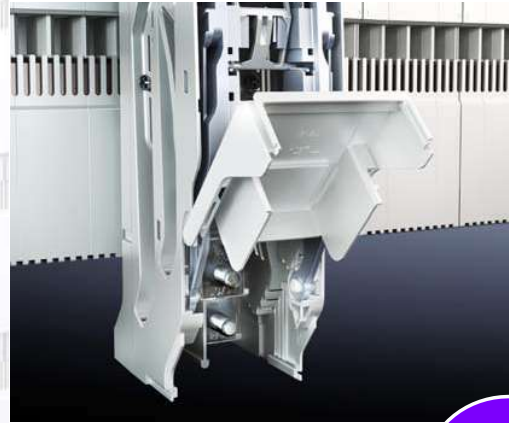

NH slimline switch-disconnectors with fuses, size 00 to 3

- Disconnect and switch with one device
- Integral, user-independent quick-break contact ensures safe operation
- User-friendly cable connection from above or below
- Versions with and without fuse monitoring.
- Integral switch position display
- No-drill contacting with clamping screw attachment
- Double-break allows de-energised fuse replacement



Busbar support (185 mm)



Component adaptors Page 334 **Connection adaptors** Page 332 **Connection block** Page 333 **NH slimline switch-disconnectors** Page 336

Material:

- Polyamide (PA 6.6)
- Fire protection corresponding to UL 94-V0

Colour:

- RAL 7035

Supply includes:

- Including assembly components for contact hazard protection cover (base tray)

			
Bar centre distance mm	Packs of	185	Page
Number of poles		3-pole	
For busbars mm		40 x 10 60 x 10 80 x 10 100 x 10 120 x 10	
Model No.	2 pc(s).	9677.500	
Accessories			
Busbars E-Cu		see page	331
Contact hazard protection cover plate		see page	343
End covers	2 pc(s).	9677.600	342

Busbar system (185 mm)

Busbar supports

Note:

Required quantity when using in the enclosure width
 – 600/800 mm: 2 pc(s).
 – 1000/1200 mm: 3 pc(s).



Number of poles	P. of	3-pole	Page
Bar centre distance mm		185	
Model No.	2 pc(s).	9677.500	330

Busbars E-Cu, length: 2400 mm/bar

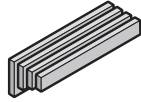

Dimensions mm	P. of	Model No.	Page
40 x 10	3 pc(s).	3587.000	308
60 x 10	2 pc(s).	3589.005	
80 x 10	1 pc(s).	3590.005	
100 x 10	1 pc(s).	3590.015	
120 x 10	1 pc(s).	3590.020	

Accessories

Busbar connector		see page	342
------------------	--	----------	-----

System attachment



For enclosure width mm	P. of	Model No.	Page
600	1 pc(s).	9677.510	342
800	1 pc(s).	9677.520	
1000	1 pc(s).	9677.530	
1200	1 pc(s).	9677.540	

Accessories

TS punched section with mounting flange, 17 x 73 mm



For enclosure depth mm	P. of	Model No.	Page
500	4 pc(s).	8612.150	717
600	4 pc(s).	8612.160	
800	4 pc(s).	8612.180	

Contact hazard protection

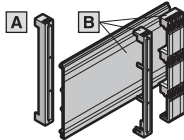

Components	For enclosure width mm	P. of	Model No.	Page
A End covers l/r	–	2 pc(s).	9677.600	342
B Cover plate, contact hazard protection (cover section, base tray, trim section)	600	1 pc(s).	9677.550	343
	800	1 pc(s).	9677.560	
	1000	1 pc(s).	9677.570	
	1200	1 pc(s).	9677.580	

Connection adaptors

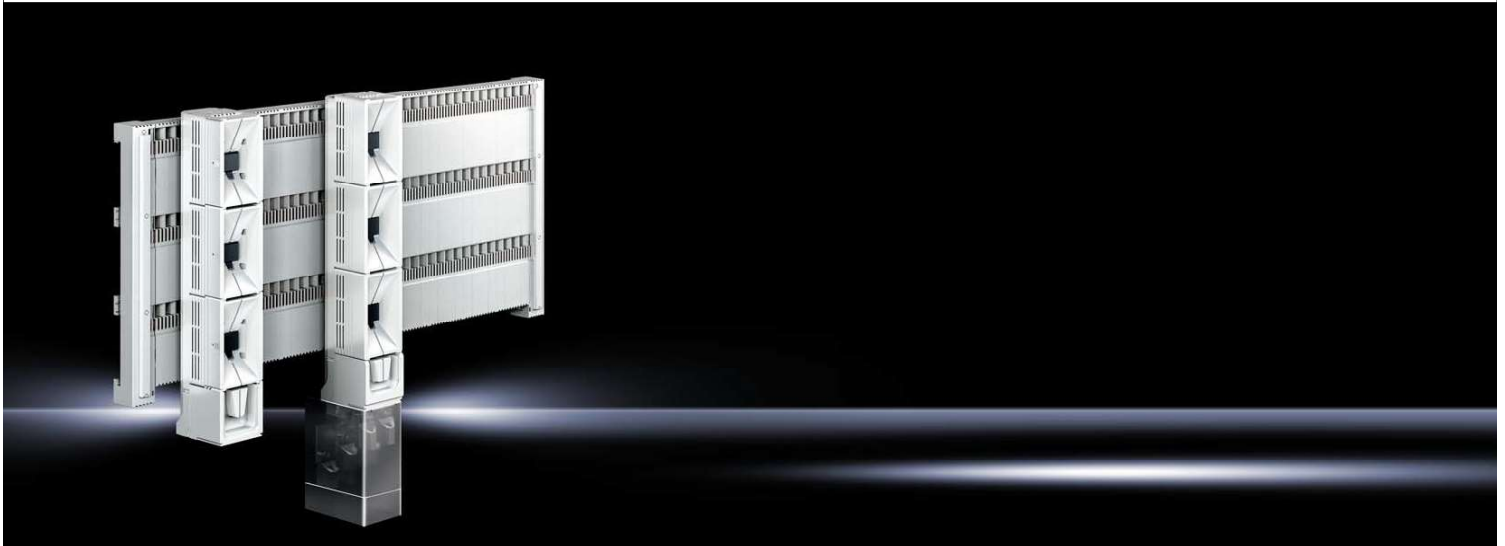

Busbar system Page 330 **Connection block** Page 333 **Component adaptors** Page 334 **NH slimline switch-disconnectors** Page 336

Material:

- Chassis: Fibreglass-reinforced polyester
- Fire protection corresponding to UL 94-V0

Colour:

- RAL 7035

Note:

- When using components on busbars with contact hazard protection cover, the contact terminal must be used

Rated current max. 800 – 1400 A

Rated current max. A	Packs of	800	1400	Page
Rated operating voltage V, ~		690, 3~	690, 3~	
Number of poles		3-pole	3-pole	
Cable outlet		Bottom	Bottom	
Type of connection		Screw M12	Screw M12	
Connection of round conductors mm ²		6 - 240	6 - 300	
Width mm		100	100	
Height mm		665	960	
For bar systems with centre-to-centre spacing mm		185	185	
For bar thickness mm		10	10	
Model No.	1 pc(s).	9677.900	9677.905	
Product-specific scope of supply				
Contact hazard protection cover plate		-	■	
Accessories				
Contact terminal	3 pc(s).	9677.460	9677.460	345
Busbar terminal	3 pc(s).	9677.480	9677.480	345

Connection block



Busbar system Page 330 **Connection adaptors** Page 332 **Component adaptors** Page 334 **NH slimline switch-disconnectors** Page 336

For connecting cables and laminated copper bars.

Material:

- Sheet steel, zinc-plated
- E-Cu, tin-plated

Rated current max. 1000 – 1600 A

Rated current max. A	Packs of	1000	1600	1600	Page
Rated operating voltage V, ~		690, 1~	690, 1~	690, 1~	
Cable outlet		Top/bottom	Top/bottom	Top/bottom	
Type of connection		Box terminal	-	Ring terminal M12	
Number of connection cables max.		2	-	4	
Connection of round conductors mm ²		185 - 300	-	240	
Clamping area for laminated copper bars (W x H) mm		-	80 x 20	-	
Width mm		98	98	98	
For bar thickness mm		10	10	10	
Model No.	1 pc(s).	9677.915	9677.910	9677.920	
Also required					
Contact hazard protection cover plate	1 pc(s).	9677.925	9677.925	9677.925	344

Component adaptors



Busbar system Page 330 **Connection adaptors** Page 332 **Connection block** Page 332 **NH slimline switch-disconnectors** Page 336

Material:

- Polyamide (PA 6.6)
- Fire protection corresponding to UL 94-V0

Colour:

- RAL 7035

Note:

- Cable outlet: Switch outlet or as outgoing cable from the switchgear
- Suitable for the use of switchgear with front screw terminal
- For mounting on busbar systems with or without cover section

Rated current max. 630 – 1600 A, clamping attachment

Rated current max. A	Packs of	630	1000	1600	Page
Rated operating voltage V, ~		690, 3~	690, 3~	690, 3~	
Number of poles		3-pole	3-pole	3-pole	
Installation type		Clamping attachment	Clamping attachment	Clamping attachment	
Cable outlet		Bottom	Bottom	Bottom	
For switchgear make (model)		ABB (Tmax T5) Eaton (NZM3) Schneider Electric (NSX630) Siemens (3VA2, 3VL4)	ABB (Tmax T7 - 800 A/1000 A) Eaton (NZM4 - 800 A/1000 A) Schneider Electric (NS - 800 A/1000 A) Siemens (VL1250/3VL7 - 1000 A)	ABB (Tmax T7 - 1250 A/1600 A) Eaton (NZM4 - 1250 A/1600 A) Schneider Electric (NS - 1250 A/1600 A) Siemens (VL1250/3VL7 - 1250 A, VL1600/3VL8 - 1600 A)	
Width mm		150	300	300	
Height mm		585	652	652	
For bar systems with centre-to-centre spacing mm		185	185	185	
For bar thickness mm		10	10	10	
Model No.	1 pc(s).	9677.770	9677.700	9677.710	
Product-specific scope of supply					
Connection straps		■	-	-	
Also required					
Connector kit		-	see page	see page	344
Contact hazard protection cover plate		-	see page	see page	344

Component adaptors



Busbar system Page 330 **Connection adaptors** Page 332 **Connection block** Page 333 **NH slimline switch-disconnectors** Page 336

Material:

- Polyamide (PA 6.6)
- Fire protection corresponding to UL 94-V0

Colour:

- RAL 7035

Note:

- Cable outlet: Switch outlet or as outgoing cable from the switchgear
- Suitable for the use of switchgear with front screw terminal
- For attaching to busbars with holes. Please ensure that there is no cover section installed in the vicinity of the device.

Rated current max. 630 – 1600 A, screw attachment

Rated current max. A	Packs of	630	1000	1600	Page
Rated operating voltage V, ~		690, 3~	690, 3~	690, 3~	
Number of poles		3-pole	3-pole	3-pole	
Installation type		Screw attachment	Screw attachment	Screw attachment	
Cable outlet		Bottom	Bottom	Bottom	
For switchgear make (model)		ABB (Tmax T5) Eaton (NZM3) Schneider Electric (NSX630) Siemens (3VA2, 3VL4)	ABB (Tmax T7 - 800 A/1000 A) Eaton (NZM4 - 800 A/1000 A) Schneider Electric (NS - 800 A/1000 A) Siemens (VL1250/3VL7 - 1000 A)	ABB (Tmax T7 - 1250 A/1600 A) Eaton (NZM4 - 1250 A/1600 A) Schneider Electric (NS - 1250 A/1600 A) Siemens (VL1250/3VL7 - 1250 A, VL1600/3VL8 - 1600 A)	
Width mm		150	300	300	
Height mm		585	652	652	
For bar systems with centre-to-centre spacing mm		185	185	185	
For bar thickness mm		10	10	10	
Model No.	1 pc(s).	9677.780	9677.705	9677.715	
Product-specific scope of supply					
Connection straps		■	-	-	
Also required					
Connector kit		-	see page	see page	344
Contact hazard protection cover plate		-	see page	see page	344

NH slimline fuse-switch disconnectors



Busbar system Page 330 **Connection adaptors** Page 332 **Connection block** Page 333 **Component adaptors** Page 334

Material:

- Polyamide (PA 6.6)
- Fire protection corresponding to UL 94-V0
- Contact tracks: Partially silver-plated hard copper

Colour:

- Chassis: RAL 7035
- Cover: RAL 7001
- Handle: RAL 7016

Basis of test:

- IEC/DIN EN 60 947-3
- DIN EN 60 269-2 (fuse inserts)

Note:

- When using components on busbars with contact hazard protection cover, the contact terminal must be used

Size 00 – 3, design single-pole, switchable

Size	Packs of	00	1	2	3	Page
Twin track		-	-	-	-	
Rated operating current max. A		160	250	400	630	
Rated operating voltage V, ~		690, 3~	690, 3~	690, 3~	690, 3~	
Number of poles		3-pole	3-pole	3-pole	3-pole	
Cable outlet		Top/bottom	Top/bottom	Top/bottom	Top/bottom	
Type of connection		Screw M8	Bolt M12	Bolt M12	Bolt M12	
Connection of round conductors mm ²		1.5 - 95	6 - 240	6 - 240	6 - 240	
Width mm		50	100	100	100	
Height mm		670	670	670	670	
For converter installation		■	■	■	■	
For bar systems with centre-to-centre spacing mm		185	185	185	185	
For bar thickness mm		10	10	10	10	
Note on Model No.		-	-	-	-	
Model No.	1 pc(s).	9677.010	9677.110	9677.210	9677.310	
Accessories						
Connection space cover	1 pc(s).	see page	9677.410	9677.410	9677.410	345
Contact terminal	3 pc(s).	9677.450	9677.460	9677.460	9677.460	345
Busbar terminal	3 pc(s).	9677.470	9677.480	9677.480	9677.480	345
Prism terminal	3 pc(s).	9677.420	-	-	-	346
V connection terminal	3 pc(s).	-	9677.430	9677.430	9677.440	346
Micro-switch	5 pc(s).	3071.000	3071.000	3071.000	3071.000	348
Current converter	1 pc(s).	9677.810	see page	see page	see page	346
Cover	5 pc(s).	-	9677.415	9677.415	9677.415	347

NH slimline fuse-switch disconnectors

Size 00 – 1, design 3-pole, switchable

Size	Packs of	00	00	1	Page
Twin track		–	–	–	
Rated operating current max. A		160	160	250	
Rated operating voltage V, ~		690, 3~	690, 3~	690, 3~	
Number of poles		3-pole	3-pole	3-pole	
Cable outlet		Top/bottom	Top/bottom	Top/bottom	
Type of connection		Screw M8	Box terminal	Bolt M12	
Connection of round conductors mm ²		1.5 - 95	1.5 - 95	6 - 240	
Width mm		50	50	100	
Height mm		670	670	670	
For converter installation		■	■	■	
For bar systems with centre-to-centre spacing mm		185	185	185	
For bar thickness mm		10	10	10	
Note on Model No.		–	–	–	
Model No.	1 pc(s).	9677.000	9677.025	9677.100	
Accessories					
Connection space cover	1 pc(s).	see page	see page	9677.410	345
Contact terminal	3 pc(s).	9677.450	9677.450	9677.460	345
Busbar terminal	3 pc(s).	9677.470	9677.470	9677.480	345
Prism terminal	3 pc(s).	9677.420	–	–	346
V connection terminal	3 pc(s).	–	–	9677.430	346
Micro-switch	5 pc(s).	3071.000	3071.000	3071.000	348
Current converter	1 pc(s).	9677.810	9677.810	see page	346
Cover	5 pc(s).	–	–	9677.415	347

Size 2 – 3, design 3-pole, switchable

Size	Packs of	2	3	3	Page
Twin track		–	–	■	
Rated operating current max. A		400	630	1250	
Rated operating voltage V, ~		690, 3~	690, 3~	690, 3~	
Number of poles		3-pole	3-pole	3-pole	
Cable outlet		Top/bottom	Top/bottom	Bottom	
Type of connection		Bolt M12	Bolt M12	Bolt M12	
Connection of round conductors mm ²		6 - 240	6 - 240	6 - 240	
Width mm		100	100	200	
Height mm		670	670	670	
For converter installation		■	■	■	
For bar systems with centre-to-centre spacing mm		185	185	185	
For bar thickness mm		10	10	10	
Note on Model No.		–	–	Special design	
Model No.	1 pc(s).	9677.200	9677.300	9677.340	
Accessories					
Connection space cover	1 pc(s).	9677.410	9677.410	–	345
Contact terminal	3 pc(s).	9677.460	9677.460	9677.460	345
Busbar terminal	3 pc(s).	9677.480	9677.480	9677.480	345
Prism terminal		–	–	–	
V connection terminal	3 pc(s).	9677.430	9677.440	–	346
Micro-switch	5 pc(s).	3071.000	3071.000	3071.000	348
Current converter		see page	see page	see page	346
Cover	5 pc(s).	9677.415	9677.415	–	347

NH slimline fuse-switch disconnectors



Busbar system Page 330 **Connection adaptors** Page 332 **Connection block** Page 333 **Component adaptors** Page 334

Material:

- Polyamide (PA 6.6)
- Fire protection corresponding to UL 94-V0
- Contact tracks: Partially silver-plated hard copper

Colour:

- Chassis: RAL 7035
- Cover: RAL 7001
- Handle: RAL 7016

Basis of test:

- IEC/DIN EN 60 947-3
- DIN EN 60 269-2 (fuse inserts)

Note:

- When using components on busbars with contact hazard protection cover, the contact terminal must be used

Size 00 – 3, with electronic fuse monitoring

Size	Packs of	00	1	2	3	Page
Design		3-pole, switchable	3-pole, switchable	3-pole, switchable	3-pole, switchable	
Rated operating current max. A		160	250	400	630	
Rated operating voltage V, ~		400, 3~	400, 3~	400, 3~	400, 3~	
Number of poles		3-pole	3-pole	3-pole	3-pole	
Cable outlet		Top/bottom	Top/bottom	Top/bottom	Top/bottom	
Type of connection		Screw M8	Bolt M12	Bolt M12	Bolt M12	
Connection of round conductors mm ²		1.5 - 95	6 - 240	6 - 240	6 - 240	
Width mm		50	100	100	100	
Height mm		830	830	830	830	
For converter installation		■	■	■	■	
For bar systems with centre-to-centre spacing mm		185	185	185	185	
For bar thickness mm		10	10	10	10	
Model No.	1 pc(s).	9677.015	9677.115	9677.215	9677.315	
Accessories						
Connection space cover	1 pc(s).	see page	9677.410	9677.410	9677.410	345
Contact terminal	3 pc(s).	9677.450	9677.460	9677.460	9677.460	345
Busbar terminal	3 pc(s).	9677.470	9677.480	9677.480	9677.480	345
Prism terminal	3 pc(s).	9677.420	-	-	-	346
V connection terminal	3 pc(s).	-	9677.430	9677.430	9677.440	346
Micro-switch	5 pc(s).	3071.000	3071.000	3071.000	3071.000	348
Current converter	1 pc(s).	9677.810	see page	see page	see page	346
Cover	5 pc(s).	-	9677.415	9677.415	9677.415	347

NH slimline switch-disconnectors



Busbar system Page 330 **Connection adaptors** Page 332 **Connection block** Page 333 **Component adaptors** Page 334

Functions:

- Automatic quick-break contact allows operator-independent switching
- Double-break for reliable disconnection of the contacts

Material:

- Polyamide
- Fire protection corresponding to UL 94-V0
- Contact tracks: Partially silver-plated hard copper

Colour:

- Chassis: RAL 7035
- Cover: RAL 7001
- Handle: RAL 7016

Basis of test:

- IEC/DIN EN 60 947-3
- DIN EN 60 269-2 (fuse inserts)

Size 00, design 3-pole, switchable

Size	Packs of	00	00	00	00	Page
Rated operating current max. A		160	160	160	160	
Rated operating voltage V, ~		690, 3~	690, 3~	690, 3~	690, 3~	
Number of poles		3-pole	3-pole	3-pole	3-pole	
Installation type		Clamping attachment	Clamping attachment	Screw attachment	Screw attachment	
Cable outlet		Bottom	Top	Bottom	Top	
Type of connection		Screw M8	Screw M8	Screw M8	Screw M8	
Connection of round conductors mm ²		1.5 - 95	1.5 - 95	1.5 - 95	1.5 - 95	
Width mm		50	50	50	50	
Height mm		676	676	676	676	
For converter installation		■	■	■	■	
For bar systems with centre-to-centre spacing mm		185	185	185	185	
For bar thickness mm		10	10	10	10	
Model No.	1 pc(s).	9677.060	9677.070	9677.065	9677.075	
Accessories						
Connection space cover	1 pc(s).	9677.400	9677.400	9677.400	9677.400	345
Connection space cover, rear	1 pc(s).	9677.402	9677.402	9677.402	9677.402	347
Clamp-type terminal	3 pc(s).	9677.425	9677.425	9677.425	9677.425	347
Box terminal		–	–	–	–	
Contact terminal		–	–	–	–	
Micro-switch	1 pc(s).	9677.418	9677.418	9677.418	9677.418	348
Current converter	1 pc(s).	9677.810	9677.810	9677.810	9677.810	346

NH slimline switch-disconnectors

Size 1 – 2, design 3-pole, switchable

Size	Packs of	1	1	2	Page
Rated operating current max. A		250	250	400	
Rated operating voltage V, ~		690, 3~	690, 3~	690, 3~	
Number of poles		3-pole	3-pole	3-pole	
Installation type		Screw attachment	Screw attachment	Screw attachment	
Cable outlet		Bottom	Top	Bottom	
Type of connection		Bolt M12	Bolt M12	Bolt M12	
Connection of round conductors mm ²		6 - 240	6 - 240	6 - 240	
Width mm		100	100	100	
Height mm		772	772	772	
For converter installation		-	-	-	
For bar systems with centre-to-centre spacing mm		185	185	185	
For bar thickness mm		10	10	10	
Model No.	1 pc(s).	9677.160	9677.165	9677.260	
Accessories					
Connection space cover	1 pc(s).	9677.410	9677.410	9677.410	345
Connection space cover, rear	1 pc(s).	9677.412	9677.412	9677.412	347
Clamp-type terminal		-	-	-	
Box terminal		see page	see page	see page	348
Contact terminal	3 pc(s).	9677.485	9677.485	9677.485	348
Micro-switch	1 pc(s).	9677.418	9677.418	9677.418	348
Current converter		-	-	-	

Size 2 – 3, design 3-pole, switchable

Size	Packs of	2	3	3	Page
Rated operating current max. A		400	630	630	
Rated operating voltage V, ~		690, 3~	690, 3~	690, 3~	
Number of poles		3-pole	3-pole	3-pole	
Installation type		Screw attachment	Screw attachment	Screw attachment	
Cable outlet		Top	Bottom	Top	
Type of connection		Bolt M12	Bolt M12	Bolt M12	
Connection of round conductors mm ²		6 - 240	6 - 240	6 - 240	
Width mm		100	100	100	
Height mm		772	772	772	
For converter installation		-	-	-	
For bar systems with centre-to-centre spacing mm		185	185	185	
For bar thickness mm		10	10	10	
Model No.	1 pc(s).	9677.265	9677.360	9677.365	
Accessories					
Connection space cover	1 pc(s).	9677.410	9677.410	9677.410	345
Connection space cover, rear	1 pc(s).	9677.412	9677.412	9677.412	347
Clamp-type terminal		-	-	-	
Box terminal		see page	see page	see page	348
Contact terminal	3 pc(s).	9677.485	9677.485	9677.485	348
Micro-switch	1 pc(s).	9677.418	9677.418	9677.418	348
Current converter		-	-	-	

NH slimline switch-disconnectors



Busbar system Page 330 **Connection adaptors** Page 332 **Connection block** Page 333 **Component adaptors** Page 334

Functions:

- Automatic quick-break contact allows operator-independent switching
- Double-break for reliable disconnection of the contacts

Material:

- Polyamide
- Fire protection corresponding to UL 94-V0
- Contact tracks: Partially silver-plated hard copper

Colour:

- Chassis: RAL 7035
- Cover: RAL 7001
- Handle: RAL 7016

Basis of test:

- IEC/DIN EN 60 947-3
- DIN EN 60 269-2 (fuse inserts)

Size 00 – 3, with electronic fuse monitoring

Size	Packs of	00	00	1	2	3	Page
Design		3-pole, switchable	3-pole, switchable	3-pole, switchable	3-pole, switchable	3-pole, switchable	
Rated operating current max. A		160	160	250	400	630	
Rated operating voltage V, ~		400, 3~	400, 3~	400, 3~	400, 3~	400, 3~	
Number of poles		3-pole	3-pole	3-pole	3-pole	3-pole	
Installation type		Clamping attachment	Screw attachment	Screw attachment	Screw attachment	Screw attachment	
Cable outlet		Bottom	Bottom	Bottom	Bottom	Bottom	
Type of connection		Screw M8	Screw M8	Bolt M12	Bolt M12	Bolt M12	
Connection of round conductors mm ²		1.5 - 95	1.5 - 95	6 - 240	6 - 240	6 - 240	
Width mm		50	50	100	100	100	
Height mm		860	860	941	941	941	
For converter installation		■	■	–	–	–	
For bar systems with centre-to-centre spacing mm		185	185	185	185	185	
For bar thickness mm		10	10	10	10	10	
Model No.	1 pc(s).	9677.080	9677.085	9677.180	9677.280	9677.380	
Accessories							
Connection space cover	1 pc(s).	9677.400	9677.400	9677.410	9677.410	9677.410	345
Connection space cover, rear	1 pc(s).	9677.402	9677.402	9677.412	9677.412	9677.412	347
Clamp-type terminal	3 pc(s).	9677.425	9677.425	–	–	–	347
Box terminal		–	–	see page	see page	see page	348
Contact terminal	3 pc(s).	–	–	9677.485	9677.485	9677.485	348
Micro-switch	1 pc(s).	9677.418	9677.418	9677.418	9677.418	9677.418	348
Current converter	1 pc(s).	9677.810	9677.810	–	–	–	346

Busbar system 185 mm

Accessories



System attachment

for TS, SE

For attaching busbar systems with 185 mm centre-to-centre spacing in TS/SE enclosures.

Material:

- Sheet steel

Surface finish:

- Zinc-plated

Supply includes:

- 2 system attachments (left/right)
- 2 punched sections without mounting flanges
- Assembly parts

For enclosure width mm	Product-specific scope of supply	Packs of	Model No.
600	-	1 pc(s).	9677.510
800	-	1 pc(s).	9677.520
1000	System attachment (centre)	1 pc(s).	9677.530
1200	System attachment (centre)	1 pc(s).	9677.540

Assembly instruction:

- For variable depth adjustment of the busbar system in the enclosure, the TS punched section with mounting flange 17 x 73 mm (for the outer mounting level) is additionally required. Select according to the enclosure depth.



Busbar connectors

For connecting rectangular busbars, no drilling required.

Material:

- E-Cu

Surface finish:

- Tin-plated

Note:

- If using a 100 x 10 mm busbar, one 9677.610 and one 9677.620 are required

For busbars mm	Quantity required per bar	Length mm	Packs of	Model No.
40 x 10	1	40	1 pc(s).	9677.610
80 x 10	2			
100 x 10	1			
60 x 10	1	60	1 pc(s).	9677.620
100 x 10	1			
120 x 10	2			



End covers

for busbar supports

For contact hazard protection of the busbar system on the left and right. Attachment is on the busbar support.

Material:

- Polyamide (PA 6,6)
- Fire protection corresponding to UL 94-V0

Colour:

- RAL 7035

Supply includes:

- 1 end cover, left
- 1 end cover, right

To fit Model No.	Packs of	Model No.
9677.500	2 pc(s).	9677.600

Busbar system 185 mm

Accessories

Contact hazard protection cover plate

for busbar system

For contact hazard protection of the busbar assembly at the rear and front. To fit enclosures TS/SE.

Material:

- Base tray: Polyphenylene ether (PPE)
- End section: Polyphenylene ether (PPE)
- Cover section: Polyamide (PA 6.6)
- Centre cover: Polyamide (PA 6.6)

Colour:

- RAL 7035

Supply includes:

- Cover section, slotted, 50 mm wide
- Cover sections, slotted, 100 mm wide
- Base trays
- Trim sections

For enclosure width mm	Product-specific scope of supply	Packs of	Model No.
600	-	1 pc(s).	9677.550
800	-	1 pc(s).	9677.560
1000	Centre cover for busbar support	1 pc(s).	9677.570
1200	Centre cover for busbar support	1 pc(s).	9677.580



Accessories:

- Cover strips, see page 343

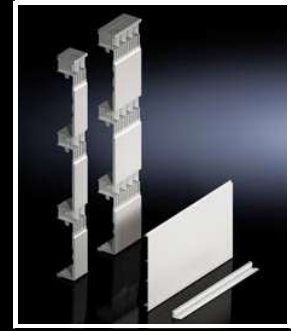

Cover strips

for contact hazard protection cover

For covering the front exposed contact slots in the cover section.

Material:

- Polyamide (PA 6)
- Fire protection corresponding to UL 94-V0

Colour:

- RAL 7035

Width mm	Height mm	To fit Model No.	Packs of	Model No.
100	67	9677.550/ 9677.560/ 9677.570/ 9677.580	3 pc(s).	9677.650

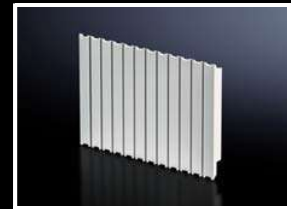

Contact hazard protection cover plate

for enclosure connection

For rear and front contact hazard protection of the connection points from enclosure to enclosure, with and without busbar connectors.

Material:

- Base tray: Polyphenylene ether (PPE)
- Cover section: Polyamide (PA 6.6)
- Centre cover: Polyamide (PA 6.6)

Colour:

- RAL 7035

Supply includes:

- 3 base trays
- 1 cover (front)
- 2 centre covers for busbar support

Packs of	Model No.
1 pc(s).	9677.640



Busbar system 185 mm

Accessories



Contact hazard protection cover plate

for connection block

To cover the connector block at the front.

Material:

- Polyamide
- Fire protection corresponding to UL 94-V0

Colour:

- RAL 7035

Width mm	Height mm	Packs of	Model No.
130	255	1 pc(s).	9677.925



Connector kit

for component adaptors

Preassembled connector kit for common brands of moulded-case circuit-breaker (MCCB). For electrical connection between the switch and the component adaptor (3-pole).

Material:

- E-Cu

Supply includes:

- Assembly parts

For switchgear make (model)	To fit Model No.	Packs of	Model No.
ABB (Tmax T7 - 800 A/1000 A) Schneider Electric (NS - 800 A/1000 A)	9677.700/9677.705	1 pc(s).	9677.730
Eaton (NZM4 - 800 A/1000 A) Siemens (VL1250/3VL7 - 1000 A)	9677.700/9677.705	1 pc(s).	9677.740
ABB (Tmax T7 - 1250 A/1600 A) Schneider Electric (NS - 1250 A/1600 A)	9677.710/9677.715	1 pc(s).	9677.750
Eaton (NZM4 - 1250 A/1600 A) Siemens (VL1250/3VL7 - 1250 A, VL1600/VL8 - 1600 A)	9677.710/9677.715	1 pc(s).	9677.760

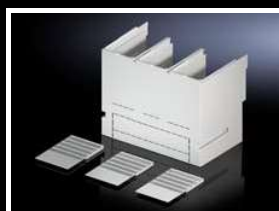

Contact hazard protection cover plate

for component adaptors

To cover the connector kit at the front. The cover may also optionally be used for the switchgear cable connection. Open cable accesses in the contact hazard protection cover may be sealed using the side panels.

Material:

- Polyamide (PA 6.6)
- Fire protection corresponding to UL 94-V0

Supply includes:

- Side panels

For switchgear make (model)	Packs of	Model No.
-	1 pc(s).	9677.790
ABB (Tmax T7)	1 pc(s).	9677.792
Eaton (NZM 4)	1 pc(s).	9677.794
Siemens (3VL7/3VL8)	1 pc(s).	9677.796
Schneider Electric (NS1600)	1 pc(s).	9677.798

Busbar system 185 mm

Accessories

Connection space cover

for NH slimline fuse-switch-disconnectors/ NH slimline switch-disconnectors

Cascadable connection space cover to guarantee contact hazard protection in the cable connection zone when using ring terminals with a long collar.

Material:

- Polycarbonate
- Fire protection corresponding to UL 94-V0

Note:

- When using NH slimline fuse-switch disconnectors with top cable outlet, use of the connection space cover is mandatory

For size	To fit Model No.	Cable outlet	Note on Model No.	Packs of	Model No.
00	9677.0X0/ 9677.0X5	Bottom	Also suitable for use with NH slimline switch-disconnectors with top cable outlet	1 pc(s).	9677.400
00	9677.000/ 9677.010/ 9677.015/ 9677.025	Top	-	1 pc(s).	9677.405
1 - 3	9677.1X0/ 9677.1X5/ 9677.2X0/ 9677.2X5/ 9677.300/ 9677.310/ 9677.3X5	Top/bottom	-	1 pc(s).	9677.410



Contact terminal

for NH slimline fuse-switch disconnectors/ connection adaptors

For mounting components on busbar systems with 185 mm centre-to-centre spacing, no drilling required.

Material:

- Sheet steel, zinc-plated
- E-Cu, tin-plated

Note:

- Only suitable for use on busbar system with contact hazard protection cover (cover section, slotted)

For size	Packs of	Model No.
00	3 pc(s).	9677.450
1 - 3 and connection adaptor	3 pc(s).	9677.460



Busbar terminal

for NH slimline fuse-switch disconnectors/ connection adaptors

For mounting components on busbar systems with 185 mm centre-to-centre spacing, no drilling required.

Material:

- Sheet steel

Surface finish:

- Zinc-plated

Note:

- Can only be used on busbar system without contact hazard protection cover (cover section, slotted)

For size	Packs of	Model No.
00	3 pc(s).	9677.470
1 - 3 and connection adaptor	3 pc(s).	9677.480



Busbar system 185 mm

Accessories



Prism terminal

for NH slimline fuse-switch disconnectors
For the direct connection of round conductors.

Material:
– Brass

Surface finish:
– Tin-plated

For size	To fit Model No.	Connection of round conductors mm ²	Packs of	Model No.
00	9677.000/ 9677.010/ 9677.015	10 - 95	3 pc(s).	9677.420



V connection terminal

for NH slimline fuse-switch disconnectors
For the direct connection of round conductors.

Material:
– Brass

Surface finish:
– Tin-plated

For size	To fit Model No.	Connection of round conductors mm ²	Packs of	Model No.
1/2	9677.100/ 9677.110/ 9677.115/ 9677.200/ 9677.210/ 9677.215	70 - 240	3 pc(s).	9677.430
3	9677.300/ 9677.310/ 9677.315	120 - 300	3 pc(s).	9677.440



Current converter

for NH slimline fuse-switch disconnectors/
NH slimline switch disconnectors

Compact design without altering the installation depth via mechanical integration into the NH slimline switch-disconnector (185 mm centre-to-centre spacing); this allows space-saving assembly.

Material:
– Polyamide (PA 6.6)

Basis of test:
– IEC 60 044-1
– EN 60 715
– DIN VDE 0414
– DIN 42 600-2



For size	00	1 - 3	1 - 3	1 - 3	1 - 3
To fit Model No.	9677.000/ 9677.010/ 9677.015/ 9677.025/ 9677.060/ 9677.065/ 9677.070/ 9677.075/ 9677.080/ 9677.085	9677.100/ 9677.110/ 9677.115/ 9677.200/ 9677.210/ 9677.215/ 9677.300/ 9677.310/ 9677.315/ 9677.340	9677.100/ 9677.110/ 9677.115/ 9677.200/ 9677.210/ 9677.215/ 9677.300/ 9677.310/ 9677.315/ 9677.340	9677.100/ 9677.110/ 9677.115/ 9677.200/ 9677.210/ 9677.215/ 9677.300/ 9677.310/ 9677.315/ 9677.340	9677.100/ 9677.110/ 9677.115/ 9677.200/ 9677.210/ 9677.215/ 9677.300/ 9677.310/ 9677.315/ 9677.340
Primary current A	150	200	250	400	600
Secondary current A	5	5	5	5	5
Accuracy class	1	1	1	1	1
Rated frequency Hz	50 - 60	50 - 60	50 - 60	50 - 60	50 - 60
Insulation voltage kV	3	3	3	3	3
Insulating material category	E	B	B	B	B
Connection of round conductors mm ²	2.5 - 4	–	–	–	–
Type of connection	Screw terminals	Round conductor 2.5 mm ² (length 1.5 m)	Round conductor 2.5 mm ² (length 1.5 m)	Round conductor 2.5 mm ² (length 1.5 m)	Round conductor 2.5 mm ² (length 1.5 m)
Rated output VA	5	1.5	2.5	2.5	2.5
Packs of	1 pc(s).	1 pc(s).	1 pc(s).	1 pc(s).	1 pc(s).
Model No.	9677.810	9677.840	9677.860	9677.870	9677.880

Busbar system 185 mm

Accessories

Cover

for NH slimline fuse-switch disconnectors

To increase rear contact hazard protection of the NH slimline fuse-switch-disconnector in the top section when mounting on a 185 mm bar system with contact hazard protection.

Material:

– Polyamide

Colour:

– RAL 7035

For size	Packs of	Model No.
1 - 3	5 pc(s).	9677.415

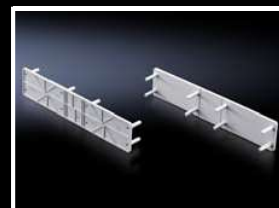

Trim strip

for NH slimline fuse-switch-disconnectors/ NH slimline switch-disconnectors

To create a contact surface for individual use of a front contact hazard protection cover plate. Mounted on the side of the NH strip enclosure.

For size	Packs of	Model No.
00 - 3	2 pc(s).	9677.407



Connection space cover, rear

for NH slimline switch-disconnectors

To guarantee contact hazard protection in the rear cable connection zone when using ring terminals with long press sleeves. In conjunction with the front connection space cover (9677.400/.410), this achieves all-round contact hazard protection of the connection space.

Material:

– Polyamide

Colour:

– RAL 7035

For size	Packs of	Model No.
00	1 pc(s).	9677.402
1 - 3	1 pc(s).	9677.412



Clamp-type terminal

for NH slimline switch-disconnectors

For the connection of round conductors.

Material:

– Sheet steel

Surface finish:

– Zinc-plated

For size	Connection of round conductors mm ²	Packs of	Model No.
00	16 - 70	3 pc(s).	9677.425



Busbar system 185 mm

Accessories



Box terminal

for NH slimline switch-disconnectors

For converting NH slimline switch-disconnectors to box terminal connection for round conductors.

Material:

- Aluminium
- E-Cu, silver-plated

Supply includes:

- Connection space cover, rear

For size	Connection of round conductors mm ²	Packs of	Model No.
1 - 3	70 - 240	3 pc(s).	9677.435
1 - 3	185 - 300	3 pc(s).	9677.445



Contact terminal

for NH slimline switch-disconnectors

For mounting NH slimline switch-disconnectors on bar systems with 185 mm centre-to-centre spacing, no drilling required.

Material:

- Sheet steel, zinc-plated
- E-Cu, tin-plated
- Polyamide

Note:

- Only suitable for use on busbar system with contact hazard protection cover (cover section, slotted)

For size	Packs of	Model No.
1 - 3	3 pc(s).	9677.485



Micro-switch

for NH slimline switch-disconnectors

To indicate the switch position of the NH unit (cover).

Supply includes:

- Bracket

For size	Packs of	Model No.
00 - 3	1 pc(s).	9677.418

Rittal – The System.

Faster – better – everywhere.

Push-in conductor connection clamps – Tool-free cable connection

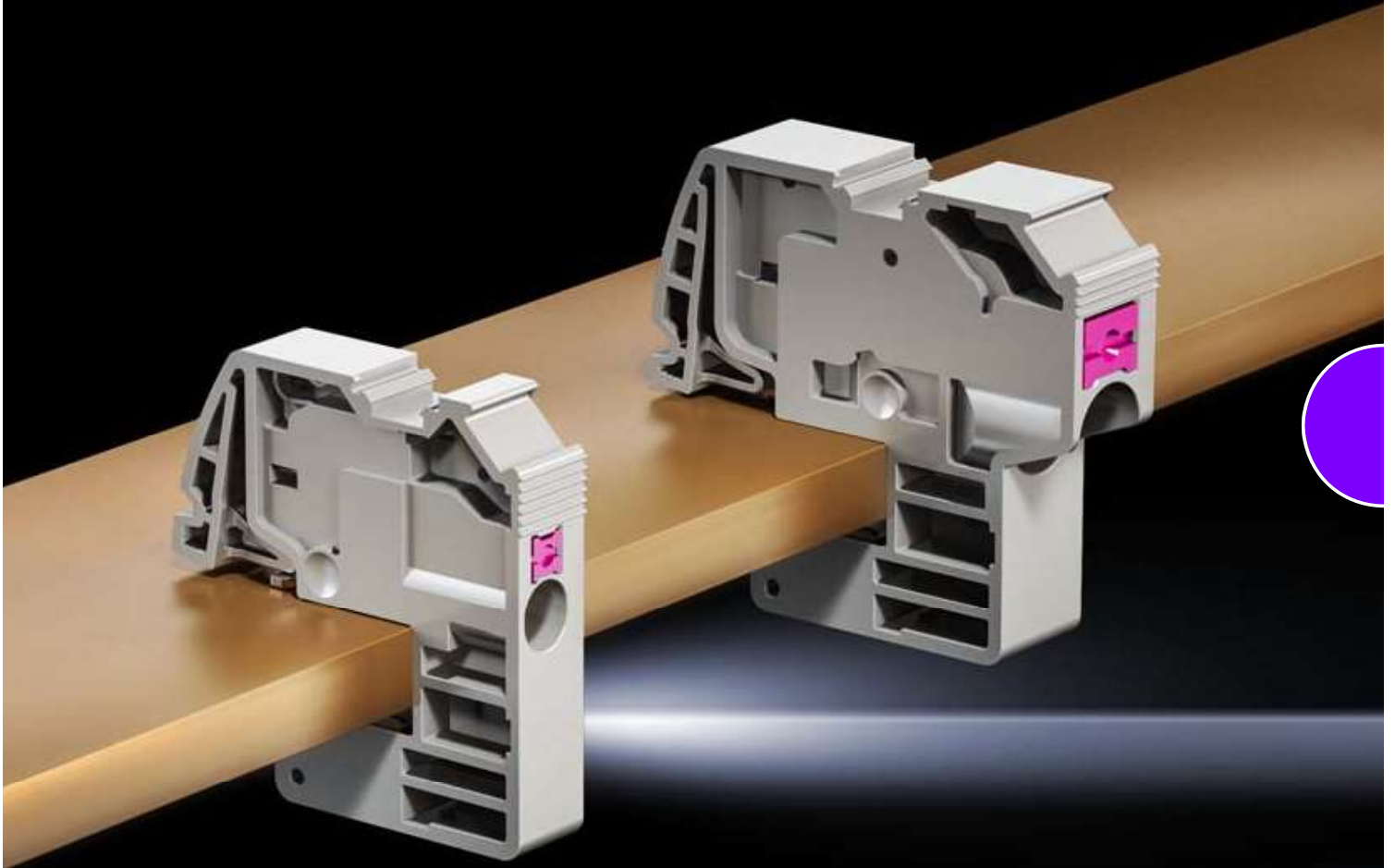

ENCLOSURES

POWER DISTRIBUTION

CLIMATE CONTROL

IT INFRASTRUCTURE

SOFTWARE & SERVICES



FRIEDHELM LOH GROUP



Ri4Power

Modular system

- For low-voltage switchgear with design verification to IEC 61 439-1/-2
- For control systems and power distributors
- Structured system solution for switchgear with Form separation 1-4b
- Simple, installation-friendly configuration of the system

Busbar systems up to 5500 A

- RiLine – The compact busbar system up to 1600 A, see page 265
- Maxi-PLS – The assembly-friendly system, see page 354
- Flat-PLS – The flat busbar system for discerning requirements, see page 357
- Tested PE conductor system, see page 766
- High short-circuit withstand current ratings of up to 100 kA for 1 sec./220 kA

Modular enclosure system

- Based on enclosure platform TS 8, see page 89
- Flexible, modular front design, see page 662
- Roof plates to suit most requirements, see page 693
- Modular compartment configuration for internal compartmentalisation up to Form 4b, see page 367
- Internal cover plates, contact hazard protection for NH fuse-switch-disconnector sections Form 2b, see page 366
- Accessories for Ri4Power, see page 374

Simple planning

- **Rittal Power Engineering with update function**
see page 377
- Configuration of low-voltage switchgear with design verification
- Simple, fast assembly with automatically generated assembly plan
- Generation of parts lists with graphical output

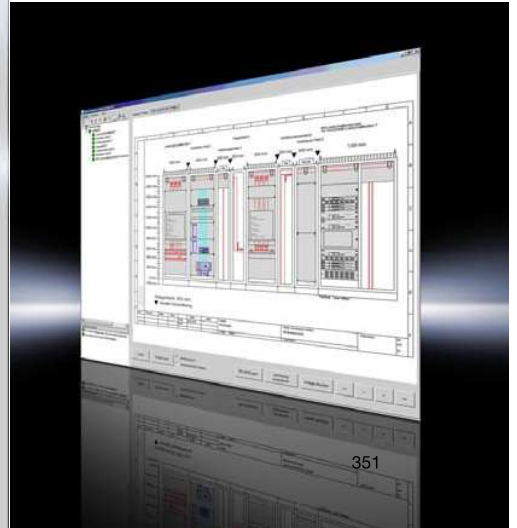

Busbar systems (100/185/150 mm)



NH slimline fuse-switch disconnectors Page 301/336 Accessories Page 374

Material:
Busbar supports, inserts
 – Fibreglass-reinforced, thermo-plastic polyester (PBT)
 – Fire protection corresponding to UL 94-V0

Colour:
 – RAL 7035

Note:
 The base component of busbar support 3052.000 may also be used as a single-pole support

Busbar systems 1250 A (100 mm), 1600 A (185 mm), 2500 A (150 mm), 3000 A (150 mm)

Busbar support, 3-pole		Packs of	Model No.				Page	
			A 1250 A	B 1600 A	C 2500 A	C 3000 A		
	Width x height x depth mm		22 x 320 x 70	24 x 515 x 51	30 x 420 x 160	30 x 420 x 170		
	Max. bar accommodation mm		60 x 10	80 x 10	2 x 80 x 10	2 x 100 x 10		
	Inserts for							
	a) Reduces the cross-section to mm		30 x 10 to 50 x 10	50/60 x 10	-	-		
	b) Reduces the bar width in 10 mm increments		-	-	■	■		
	Bar centre distance mm		100	185	150	150		
Packs of		4 pc(s)	2 pc(s)	2 pc(s)	2 pc(s)			
			3073.000	3052.000	3055.000	3057.000		
Accessories								
	Inserts to adapt the bar dimensions	30 x 10 mm	24 pc(s).	3074.000	-	-	-	
		40 x 10 mm	24 pc(s).	3075.000	-	-	-	
		50 x 10 mm	24 pc(s).	3076.000	3074.000	-	-	
		60 x 10 mm	24 pc(s).	-	3075.000	-	-	
	Spacing piece for reducing the bar width in 10 mm increments	12 pc(s).	-	-	3056.000	3056.000		
	D System attachment for rear section Material: Sheet steel Surface finish: Zinc-plated Supply includes: Assembly parts	2 pc(s).	-	9674.100	-	-		
Busbars E-Cu¹⁾ to DIN EN 13 601, length 2400 mm								
	Dimensions mm							
	30 x 10	3 pc(s).	3586.005	-	-	-		
	40 x 10	3 pc(s).	3587.000	-	-	-		
	50 x 10	2 pc(s).	3588.005	3588.005	-	-	308	
	60 x 10	2 pc(s).	3589.005	3589.005	3589.005	3589.005		
	80 x 10	1 pc(s).	-	3590.005	3590.005	3590.005		
	100 x 10	1 pc(s).	-	-	-	3590.015		
Accessories								
	Baying bracket E-Cu for	30 x 10 mm	4 pc(s).	9661.350	-	-	-	
		40 x 10 mm	4 pc(s).	9661.050	-	-	-	
		80 x 10 mm	4 pc(s).	-	9661.150	-	-	767
	Longitudinal connector for 2 x bar width x 10 mm	1 pc(s).	-	-	9676.621 ²⁾	9676.621 ²⁾	358	

¹⁾ For other busbar lengths, see page 766

²⁾ The required screw must be ordered separately according to the bar width, see page 359

Busbar systems (100/185/150 mm)

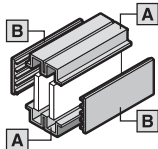
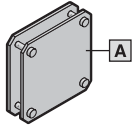
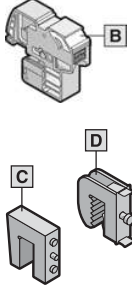
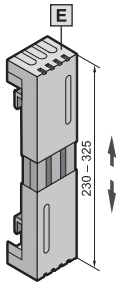
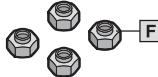
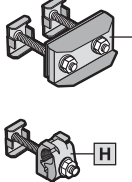
Contact hazard protection		Packs of	Model No.				Page	
			1250 A	1600 A	2500 A	3000 A		
End cover for busbar support		10 pc(s).	3083.000	–	–	–		
	Busbar cover section, length 1 m for E-Cu	30 x 10 mm	10 pc(s).	3092.000	–	–	–	308
		40 x 10 to 60 x 10 mm	10 pc(s).	3085.000	3085.000	–	–	
	Edge cover section for bar systems with 10 mm space between the strands, length 1 m	for 1 busbar per conductor	10 pc(s).	9676.041	9676.041	–	–	358
		for 2 busbars per conductor	10 pc(s).	–	–	9676.052	9676.052	
	Side cover section for busbar width	60 mm	10 pc(s).	9676.056	9676.056	9676.056	9676.056	
		80 mm	10 pc(s).	9676.058	9676.058	9676.058	9676.058	
	100 mm	10 pc(s).	9676.059	9676.059	9676.059	9676.059		
Connection system, see page 313 (system accessories)								
A Plate clamps for connecting laminated copper bars; no drilling required.								
	For busbars mm	Clamping area for laminated copper bars mm						314
	30 x 10	34 x 10	3 pc(s).	3554.000	–	–	–	
	40 x 10	34 x 10	3 pc(s).	3559.000	–	–	–	
	50 x 10	34 x 10	3 pc(s).	3560.000	3560.000	–	–	
	50 x 10	54 x 10	3 pc(s).	3562.000	3562.000	–	–	
	60 x 10	34 x 10	3 pc(s).	3561.000	3561.000	–	–	
	80 x 10	65 x 10	3 pc(s).	–	3460.500	–	–	
B Push-in conductor connection clamps for 10 mm bar thickness								
	Connection of round conductors mm ²	Clamping area for laminated copper bars mm						313
	0.5 – 6	–	10 pc(s).	3455.505	3455.505	3455.505	3455.505	
	1.5 – 16	–	10 pc(s).	3456.505	3456.505	3456.505	3456.505	
Conductor connection clamps for 10 mm bar thickness								
	Connection of round conductors mm ²	Clamping area for laminated copper bars mm						313
	C 1 – 4	–	15 pc(s).	3555.000	3555.000	3555.000	3555.000	
	1 – 4	–	15 pc(s).	3455.500	3455.500	3455.500	3455.500	
	2.5 – 16	8 x 8	15 pc(s).	3456.500	3456.500	–	–	
	D 16 – 50	10.5 x 11	15 pc(s).	3457.500	3457.500	–	–	
	35 – 70	16.5 x 15	15 pc(s).	3458.500	3458.500	–	–	
70 – 185	22.5 x 20	15 pc(s).	3459.500	3459.500	–	–		
E System covers for conductor connection clamps and plate clamps								
	Width x depth mm							314
	50 x 80	4 pc(s).	3086.000	–	–	–	–	
	100 x 80	4 pc(s).	3087.000	–	–	–	–	
	100 x 110	4 pc(s).	3090.000	–	–	–	–	
	200 x 80	4 pc(s).	3088.000	–	–	–	–	
200 x 110	4 pc(s).	3091.000	–	–	–	–		
F Inserted screw nuts M12, self-holding nuts with knurled ring for mounting NH slimline fuse-switch disconnectors								
For drilled holes in busbars Ø 14.5 mm.			30 pc(s).	3591.060	3591.060	–	–	767
G Connection plates for laminated copper bars								
	For connecting laminated copper bars up to 2 x 10 x 100 x 1.0 mm to a busbar system with 2 bars per conductor.	For laminated copper bars up to						359
		2 x 10 x 32 x 1 mm	1 pc(s).	–	–	9676.747 ¹⁾	9676.747 ¹⁾	
		2 x 10 x 63 x 1 mm	1 pc(s).	–	–	9676.748 ¹⁾	9676.748 ¹⁾	
		2 x 10 x 100 x 1 mm	1 pc(s).	–	–	9676.749 ¹⁾	9676.749 ¹⁾	
H Direct connection terminals								
For the direct connection of round conductors 95 – 300 mm ² (single-wire and multi-wire)			1 pc(s).	–	–	9676.730 ¹⁾	9676.730 ¹⁾	359

¹⁾ The required screw connection must be ordered separately according to the busbar width, see page 359

Busbar systems Maxi-PLS

System components

Note:

- Busbars for PE/PEN combinations, see page 766/767.

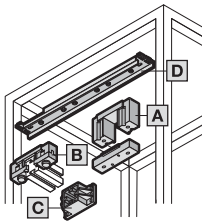
Supports and attachment in the TS enclosure				P. of		Maxi-PLS 1600/2000		Maxi-PLS 3200	
						Model No.		Model No.	
						3-pole	4-pole	3-pole	4-pole
	A Busbar support Material: Polyamide (PA 6.6)			1 pc(s).	9649.000		9659.000		
	B Busbar support, suitable for top mounting Material: Polyamide (PA 6.6)			1 pc(s).	9649.160		9659.160		
	C End support Material: Polyamide (PA 6.6)			2 pc(s).	9649.010		9659.010		
	D System attachment for installation in the busbar support. Material: Stainless steel								
For use		For enclosure depth mm	Bar centre distance mm	P. of	Model No.		Model No.		
D1 In the roof/base section directly above/below coupling switch	600	100	2 pc(s).	9640.080		-			
		150	2 pc(s).	-		9650.100			
	800	150	2 pc(s).	-		9650.080			
D2 Rear section top/bottom	-	150	2 pc(s).	9640.098		9650.098			
D3 Rear section, centre (185 mm)	-	185	2 pc(s).	3-pole	4-pole	3-pole	4-pole		
				9640.150	-	9650.150	-		

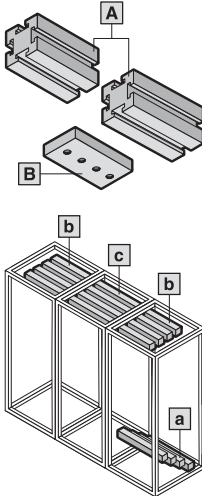

A Maxi-PLS busbars E-Cu					Maxi-PLS 1600	Maxi-PLS 2000	Maxi-PLS 3200
					Model No.		Model No.
	For enclosure width mm	For use ¹⁾	Length mm	P. of	Model No.		Model No.
	600	a	491	1 pc(s).	9640.206	9640.201	9650.201
	600	b	525	1 pc(s).	9640.216	9640.211	9650.211
	600	c	599	1 pc(s).	9640.226	9640.221	9650.221
	800	a	691	1 pc(s).	9640.236	9640.231	9650.231
	800	b	725	1 pc(s).	9640.246	9640.241	9650.241
	800	c	799	1 pc(s).	9640.256	9640.251	9650.251
	1000	a	891	1 pc(s).	9640.266	9640.261	9650.261
	1000	b	925	1 pc(s).	9640.276	9640.271	9650.271
	1000	c	999	1 pc(s).	9640.286	9640.281	9650.281
	1200	a	1091	1 pc(s).	9640.296	9640.291	9650.291
	1200	b	1125	1 pc(s).	9640.306	9640.301	9650.301
	1200	c	1199	1 pc(s).	9640.316	9640.311	9650.311
	-	-	2400	3 pc(s).	9640.365	9640.360	9650.360
-	-	2400	4 pc(s).	-	9649.360	9659.360	
B Longitudinal connector E-Cu for simple baying connection of Maxi-PLS busbars. Incl. sliding blocks, bolts, washers and nuts.				1 pc(s).	9640.191	9640.191	9650.191

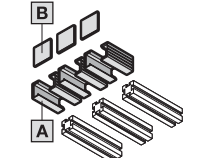
¹⁾ a = Cable connection system with end support
b = Left-hand or right-hand end enclosure in a switchgear installation
c = Bayed enclosure with sections bayed on the left and right

Contact hazard protection		P. of	Model No.	Model No.
	A Cover section for clip-on mounting onto the Maxi-PLS busbars, length 1000 mm. Material: Hard PVC	5 pc(s).	9640.050	9650.050
	B End cover for clip-on mounting onto the end surface of Maxi-PLS busbars. Material: Polyamide (PA 6.6)	2 pc(s).	9649.060	9659.060

Busbar systems Maxi-PLS

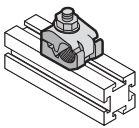
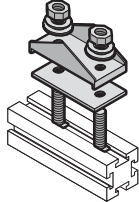
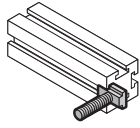
System components

Connection system			P. of	Maxi-PLS 1600/2000	Maxi-PLS 3200	
				Model No.	Model No.	
	Contact maker E-Cu for contacting the connection brackets to the Maxi-PLS busbars. Incl. sliding blocks.					
	Width mm	60	1 pc(s).	9640.171	9650.171	
100		1 pc(s).	9640.181	9650.181		
	Connection clamp for the connection of round conductors (Cu/AL) 95 to 300 mm ² (single-wire and multi-wire). Incl. assembly parts.					
			1 pc(s).	9640.325	9650.325	
	Connection plates for the connection of laminated flat copper bars. Including assembly parts.					
	Maximum clamping area	2 x 10 x 32 x 1	3 pc(s).	9640.330	9650.330	
		2 x 10 x 63 x 1	3 pc(s).	9640.340	9650.340	
2 x 10 x 100 x 1		3 pc(s).	9640.350	-		
	Terminal stud for connecting cables with ring terminals. Incl. sliding blocks.			Length 30 mm	Length 32 mm	
	Thread	M12	3 pc(s).	9640.370	9650.370	
		M16	3 pc(s).	9640.380	9650.380	
	Sliding blocks for sliding into the Maxi-PLS busbar section at the sides.					
	Thread	M8	Length 20 mm	15 pc(s).	9640.970	-
		M10	Length 25 mm	15 pc(s).	9640.980	9650.980
M12		Length 35 mm	15 pc(s).	-	9650.990	
	Sliding nuts for retrospectively inserting into the Maxi-PLS busbar section.					
	Thread	M6		15 pc(s).	9640.900	9650.900
		M8		15 pc(s).	9640.910	-
		M10		3 pc(s).	-	9650.905
M12			15 pc(s).	9640.920	9650.910	
	Threaded bolts for individual connection options. Including nuts, plain washers, spring lock washers (M6 and M8 only) or washers (M10 and M12 only). Note: Sliding blocks or sliding nuts are additionally required for attachment.					
	Thread	M6	Length 35 mm	6 pc(s).	9640.930	9640.930
		M8	Length 35 mm	6 pc(s).	9640.940	9640.940
		M10	Length 35 mm	8 pc(s).	9676.971	9676.971
		M10	Length 45 mm	8 pc(s).	9676.972	9676.972
		M10	Length 55 mm	8 pc(s).	9676.973	9676.973
		M10	Length 70 mm	8 pc(s).	9676.976	9676.976
		M10	Length 80 mm	8 pc(s).	9676.977	9676.977
		M12	Length 40 mm	8 pc(s).	-	9676.981
		M12	Length 50 mm	8 pc(s).	-	9676.982
		M12	Length 60 mm	8 pc(s).	-	9676.983
M12		Length 70 mm	8 pc(s).	-	9676.986	
M12	Length 80 mm	8 pc(s).	-	9676.987		

Busbar systems Maxi-PLS

System components

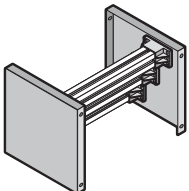
Connection system	P. of	Model No.
 <p>Compact infeed for Maxi-PLS busbar 1600/2000 For individual use as a 3-pole cable connection bar system. Direct mounting on the mounting plate or punched section without mounting flange.</p> <p>Supply includes: 6 end supports, 2 support plates for end supports, 1 PS mounting rail 23 x 23 mm (length 495 mm), mounting accessories</p>	1 pc(s).	9660.980

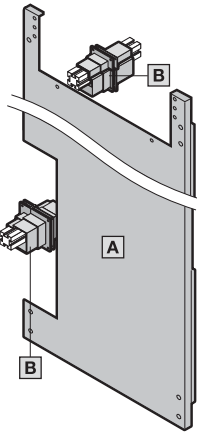
Shielding	Maxi-PLS 1600/2000		Maxi-PLS 3200																																																																																			
	Model No.		Model No.																																																																																			
 <p>A Divider panel for TS enclosures. For side shielding from neighbouring panels. Including assembly parts.</p> <p>Maxi-PLS busbars in the roof section</p> <table border="1"> <thead> <tr> <th>For enclosure depth mm</th> <th>For enclosure height mm</th> <th>P. of</th> <th>1600/2000 Model No.</th> <th>3200 Model No.</th> </tr> </thead> <tbody> <tr> <td>600</td> <td>2000</td> <td>1 pc(s).</td> <td>9660.620</td> <td>9660.620</td> </tr> </tbody> </table> <p>Maxi-PLS busbars in the rear section</p> <table border="1"> <thead> <tr> <th>For enclosure depth mm</th> <th>For enclosure height mm</th> <th>P. of</th> <th>1600/2000 Model No.</th> <th>3200 Model No.</th> </tr> </thead> <tbody> <tr> <td>600</td> <td>2000</td> <td>1 pc(s).</td> <td>9660.610</td> <td>9660.610</td> </tr> </tbody> </table> <p>B Busbar gland The busbar gland may also be used as a cover for longitudinal connectors. Including assembly parts.</p> <table border="1"> <thead> <tr> <th colspan="2">Use with longitudinal connector</th> <th rowspan="2">Packs required</th> <th rowspan="2">P. of</th> <th colspan="2">1600/2000</th> <th colspan="2">3200</th> </tr> <tr> <th>no</th> <th>yes</th> <th>3-pole</th> <th>4-pole</th> <th>3-pole</th> <th>4-pole</th> </tr> </thead> <tbody> <tr> <td>■</td> <td>-</td> <td>6</td> <td>1 pc(s).</td> <td>9640.600</td> <td>-</td> <td>9650.600</td> <td>-</td> </tr> <tr> <td>■</td> <td>-</td> <td>8</td> <td>1 pc(s).</td> <td>-</td> <td>9640.600</td> <td>-</td> <td>9650.600</td> </tr> <tr> <td>-</td> <td>■</td> <td>3</td> <td>1</td> <td>9640.610</td> <td>-</td> <td>9650.610</td> <td>-</td> </tr> <tr> <td>-</td> <td>■</td> <td>3</td> <td>1</td> <td>+ 9640.600</td> <td>-</td> <td>+ 9650.600</td> <td>-</td> </tr> <tr> <td>-</td> <td>■</td> <td>4</td> <td>1</td> <td>-</td> <td>9640.610</td> <td>-</td> <td>9650.610</td> </tr> <tr> <td>-</td> <td>■</td> <td>4</td> <td>1</td> <td>-</td> <td>+ 9640.600</td> <td>-</td> <td>+ 9650.600</td> </tr> </tbody> </table>	For enclosure depth mm	For enclosure height mm	P. of	1600/2000 Model No.	3200 Model No.	600	2000	1 pc(s).	9660.620	9660.620	For enclosure depth mm	For enclosure height mm	P. of	1600/2000 Model No.	3200 Model No.	600	2000	1 pc(s).	9660.610	9660.610	Use with longitudinal connector		Packs required	P. of	1600/2000		3200		no	yes	3-pole	4-pole	3-pole	4-pole	■	-	6	1 pc(s).	9640.600	-	9650.600	-	■	-	8	1 pc(s).	-	9640.600	-	9650.600	-	■	3	1	9640.610	-	9650.610	-	-	■	3	1	+ 9640.600	-	+ 9650.600	-	-	■	4	1	-	9640.610	-	9650.610	-	■	4	1	-	+ 9640.600	-	+ 9650.600				
	For enclosure depth mm	For enclosure height mm	P. of	1600/2000 Model No.	3200 Model No.																																																																																	
	600	2000	1 pc(s).	9660.620	9660.620																																																																																	
	For enclosure depth mm	For enclosure height mm	P. of	1600/2000 Model No.	3200 Model No.																																																																																	
	600	2000	1 pc(s).	9660.610	9660.610																																																																																	
	Use with longitudinal connector		Packs required	P. of	1600/2000		3200																																																																															
	no	yes			3-pole	4-pole	3-pole	4-pole																																																																														
	■	-	6	1 pc(s).	9640.600	-	9650.600	-																																																																														
	■	-	8	1 pc(s).	-	9640.600	-	9650.600																																																																														
	-	■	3	1	9640.610	-	9650.610	-																																																																														
-	■	3	1	+ 9640.600	-	+ 9650.600	-																																																																															
-	■	4	1	-	9640.610	-	9650.610																																																																															
-	■	4	1	-	+ 9640.600	-	+ 9650.600																																																																															

Accessories



Power Engineering

see page 377

Flat-PLS busbar systems

System components

Busbar system Flat-PLS 60/ Flat-PLS 100, for flat copper bars

For the configuration of busbar systems from flat copper bars.

For mounting on a system attachment or directly on the mounting plate.

Max. permissible tolerance of bar width (60/100 mm) ± 0.3 mm, bar thickness (10 mm) ± 0.15 mm.

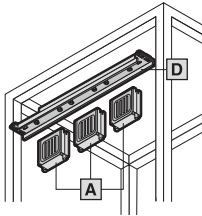
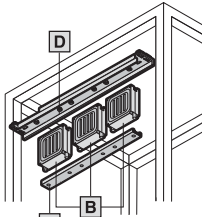
Supports and attachment in the TS enclosure				Flat-PLS 60		Flat-PLS 100			
				Model No.		Model No.			
	A Busbar support Material: Polyamide (PA 6.6)								
	System	For busbars up to mm ¹⁾		P. of					
	Flat-PLS 60	4 x 60 x 10		1 pc(s).	9676.002	-			
Flat-PLS 100	4 x 100 x 10		1 pc(s).	-	9676.004				
	B Busbar support for stabiliser bar Material: Polyamide (PA 6.6)								
	System	For busbars up to mm ¹⁾		P. of					
	Flat-PLS 60	4 x 60 x 10		1 pc(s).	9676.020	-			
Flat-PLS 100	4 x 100 x 10		1 pc(s).	-	9676.021				
D System attachment for installation in the busbar support. Material: Stainless steel									
For use	For enclosure depth mm	Bar centre distance mm			P. of	3-pole	4-pole	3-pole	4-pole
		120	165	185					
D1 In the roof/base section directly above/below coupling switch	600	■	-	-	2 pc(s).	9674.162	9674.162	-	-
		-	■	-	2 pc(s).	-	-	9674.164	-
	800	■	-	-	2 pc(s).	9674.182	9674.182	-	-
		-	■	-	2 pc(s).	-	-	9674.184	9674.184
D2 Vertical coupling set	600	■	-	-	2 pc(s).	9674.172	9674.172	-	-
		-	■	-	2 pc(s).	-	-	9674.174	-
D3 Rear section, top/bottom	800	■	-	-	2 pc(s).	9674.192	9674.192	-	-
		-	■	-	2 pc(s).	-	-	9674.194	9674.194
D4 Rear section, centre (185 mm)	-	■	-	-	2 pc(s).	9674.122	9674.122	-	-
		-	■	-	2 pc(s).	-	-	9674.124	9674.124
D5 Single-pole assembly, for mounting on the TS frame	-	-	-	■	2 pc(s).	9674.152	-	-	-
		-	-	■	2 pc(s).	-	-	9674.154	-
C Busbar stabiliser bars Material: Stainless steel									
For busbar supports	Bar centre distance mm	System layout		P. of	3-pole	4-pole	3-pole	4-pole	
9676.020	120	3-/4-pole		2 pc(s).	9676.022	9676.023	-	-	
	185	3-pole		2 pc(s).	9676.026	-	-	-	
9676.021	165	3-/4-pole		2 pc(s).	-	-	9676.024	9676.025	
	185	3-pole		2 pc(s).	-	-	9676.027	-	

¹⁾ For a bar width of < 60 mm for Flat-PLS 60 or < 100 mm for Flat-PLS 100, the empty gaps in the support should be filled with spacers. When using only 1, 2 or 3 bars, the vacant bar slots should be closed using the filler pieces.

Flat-PLS busbar systems

System components

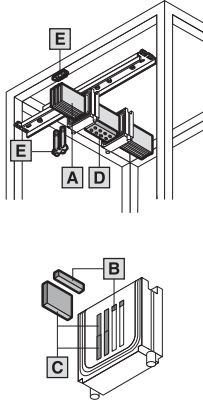
Busbars and accessories for supports				Flat-PLS 60	Flat-PLS 100
				Model No.	Model No.
	A Busbars E-Cu to DIN EN 13 601. Length: 2400 mm/bar				
	Dimensions mm		P. of		
	40 x 10		3 pc(s).	3587.000	-
	50 x 10		2 pc(s).	3588.005	-
	60 x 10		2 pc(s).	3589.005	-
	80 x 10		1 pc(s).	-	3590.005
	100 x 10		1 pc(s).	-	3590.015
	B Spacer – For a bar width of < 60/100 mm the spacer should be used. Material Polyamide (PA 6.6)				
	E-Cu dimensions mm		Required number of spacers per chamber	P. of	
	40 x 10		2 pc(s).	16 pc(s).	9676.007
50 x 10		1 pc(s).			
80 x 10		2 pc(s).			
C Filler piece – When using only 1, 2 or 3 bars, the vacant bar slots should be closed using the filler pieces. Material: Polyamide (PA 6.6)					
Flat-PLS 60		2 per free bar slot	16 pc(s).	9676.008	
Flat-PLS 100		3 per free bar slot			
D Longitudinal connector E-Cu for connecting Flat-PLS busbar systems, no drilling required.					
No. of strands per conductor	For busbar width mm	Screw	P. of		
2	40 – 100	1)	1 pc(s).	9676.621	
3 or 4	40 – 100	1)	1 pc(s).	9676.641	
1) Must be ordered separately according to the busbar width B (length = B + 40 mm, screw connections, see page 359).					
E Busbar claws for Flat-PLS					
For busbar width up to mm		Screw	P. of		
2 x B x 10		1)	1 pc(s).	9676.017	
4 x B x 10		1)	1 pc(s).	9676.019	
1) Must be ordered separately according to the busbar width B (length = B + 20 mm, screw connections, see page 359).					

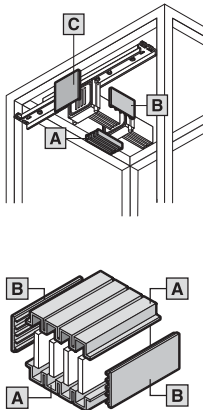
Contact hazard protection				Flat-PLS 60	Flat-PLS 100	
				Model No.	Model No.	
	Cover sections for Flat-PLS Material: Hard PVC					
	For system	No. of bars per conductor	For busbar width mm	Length mm	P. of	
	A Edge cover section for bar systems with no space between the strands	1	-	1000	10 pc(s).	9676.041
	A Edge cover section for bar systems with 10 mm space between the strands	2	-	1000	10 pc(s).	9676.052
		4	-	1000	10 pc(s).	9676.054
	B Side cover section for bar systems, to match the edge cover sections	-	60	1000	10 pc(s).	9676.056
		-	80	1000	10 pc(s).	9676.058
		-	100	1000	10 pc(s).	9676.059
	C End covers for busbar supports Flat-PLS Material: Polyamide (PA 6.6)					
	For Flat-PLS 60 and Flat-PLS 100			P. of		
			2 pc(s).	9676.006		

Flat-PLS busbar systems

System components

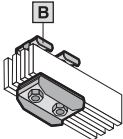
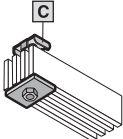
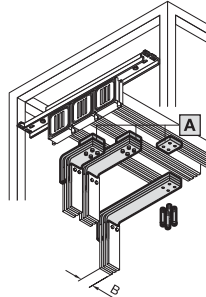
Connection system	Flat-PLS 60			Flat-PLS 100		
	Model No.			Model No.		
	A Direct connection terminal for Flat-PLS For the direct connection of round conductors.					
	For round conductors	Screw	P. of			
	95 – 300 mm ² re/m	¹⁾	1 pc(s).	9676.730		9676.730
	¹⁾ Must be ordered separately according to the busbar width B (length = B + 60 mm, screw connections, see page 359).					
	B Connection plates for laminated copper bars , including assembly parts (excluding screws)					
	For busbar width mm	Screw	P. of			
	2 x 10 x 32 x 1	¹⁾	1 pc(s).	9676.747		9676.747
	2 x 10 x 63 x 1	¹⁾	1 pc(s).	9676.748		9676.748
	C Connection plates with bolts M10 , including assembly parts (excluding screws)					
Connection bolts	Screw	P. of				
M10	¹⁾	1 pc(s).	9676.710		9676.710	
	D Connection plates with bolts M12 , including assembly parts (excluding screws)					
Connection bolts	Screw	Bolt length mm	P. of			
M12	¹⁾	30	1 pc(s).	9676.700	9676.700	
¹⁾ Must be ordered separately according to the busbar width B (length = B + 20 mm, screw connections, see page 359).						
	A Claw with threaded insert M10					
	Threaded insert			P. of		
	M10			8 pc(s).	9676.832	9676.832
	B Screw connections					
	Screw design			P. of		
	M10 x 60			8 pc(s).	9676.806	9676.806
	M10 x 70			8 pc(s).	9676.807	9676.807
	M10 x 80			8 pc(s).	9676.808	9676.808
	M10 x 90			8 pc(s).	9676.809	9676.809
	M10 x 100			8 pc(s).	9676.810	9676.810
	M10 x 110			8 pc(s).	9676.811	9676.811
	M10 x 120			8 pc(s).	9676.812	9676.812
	M10 x 130			8 pc(s).	9676.813	9676.813
	M10 x 140			8 pc(s).	9676.814	9676.814
	M10 x 150			8 pc(s).	9676.815	9676.815
M10 x 160			8 pc(s).	9676.816	9676.816	
M10 x 170			8 pc(s).	9676.817	9676.817	
M10 x 190			8 pc(s).	9676.819	9676.819	
	A Claw with threaded insert M8 for NH slimline fuse-switch disconnectors, size 00 For mounting NH slimline fuse-switch disconnectors size 00 on Flat-PLS bar systems with 185 mm centre-to-centre spacing. Note: M8 screws (zinc-plated and passivated, strength 8.8, length: busbar width + 20 mm) are additionally required. Screws are not included with the supply.					
	Threaded insert			P. of		
M8			3 pc(s).	9676.831	9676.831	
	A Contact makers E-Cu for contacting the connection brackets to the Flat-PLS busbars.					
	For busbar width B mm	Screw	No. of strands per conductor	P. of		
	60	¹⁾	2	1 pc(s).	9676.526	9676.526
	60	¹⁾	3 or 4	1 pc(s).	9676.546	9676.546
	80	¹⁾	2	1 pc(s).	9676.528	9676.528
	80	¹⁾	3 or 4	1 pc(s).	9676.548	9676.548
	100	¹⁾	2	1 pc(s).	9676.520	9676.520
100	¹⁾	3 or 4	1 pc(s).	9676.540	9676.540	

¹⁾ Must be ordered separately according to the busbar width B (screw connections, see page 359).
 Screw length = (no. of strands x 10 mm) + bar width of main busbar + 40 mm.
 No. of screws per bracket:
 – for 2 strands per conductor of the main busbar system: 2 pc(s).,
 – for 3/4 strands per conductor of the main busbar system: 4 pc(s).

Connection components for Maxi-PLS/Flat-PLS

For air circuit-breakers and busbar connections

For connecting air circuit-breakers (ACB) to Maxi-PLS/Flat-PLS busbar systems in TS enclosures. Alternatively, for connecting main and distribution busbar systems and for connecting horizontal and vertical main busbar systems.

Please include the design code of the specification given below in the order text for your connector kit.

We recommend the **Rittal Power Engineering software 3020.500 from Version 6.1** for easier configuration of the connector kits and connection brackets, see page 377.

Material:

- E-Cu

Note:

- Please quote the complete design code on all enquiries and orders.
- For configuration with the Rittal Power Engineering software, 2 check numbers are additionally output with a hyphen.



Also required:

- M10/M12 screw connections, see page 359
- Terminal studs Maxi-PLS, see page 355
- Screw connections Flat-PLS, see page 359
- Copper spacer rolls, page 374

Design code

Model No.	Enclosure	Busbar system, bottom		Air circuit-breaker							Busbar system, top		Compartment height of air circuit-breaker	Distribution busbars, type and number of poles	Distribution busbar system, in front of or behind mounting plate	Busbar configuration	Code length				
		a	b	c	d	e	f	g	h	i	j	k						l	m	n	o
9676.910	Connector kit for ACB, top																			14	
9676.912	Connector kit for ACB, bottom																				14
9676.200	Connection bracket above ACB																				14
9676.210	Connection bracket below ACB																				14
9675.100	T-connector kit																				9
9675.840	Angular connector kit																				8
9674.481	Fuse-switch-disconnector section, connection bracket																				8

Leave grey sections blank

Enclosure





							Selection		
Width mm									
	a	2 200	4 400	6 600	8 800	0 1000	1 1200	<input type="checkbox"/>	
	Height mm								
	b	0 2000	2 2200						<input type="checkbox"/>
Depth mm									
c	6 600	8 800						<input type="checkbox"/>	

Connection components for Maxi-PLS/Flat-PLS

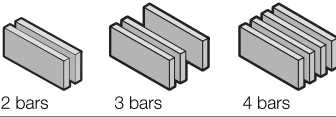
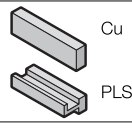
For air circuit-breakers and busbar connections

Busbar system, bottom

Busbar type				Selection	
d	 Maxi-PLS	1600	3-pole	A	<input type="checkbox"/>
			4-pole	B	
		2000	3-pole	C	
			4-pole	D	
		3200	3-pole	E	
			4-pole	F	
	 Flat-PLS	60	3-pole	I	
			4-pole	J	
		100	3-pole	M	
			4-pole	N	
	 RiLine (only for T-connector kit)	Cu 30 x 5/10 mm	3-pole	Q	
			4-pole	R	
PLS 1600		3-pole	S		
		4-pole	T		
No system available				X	

Busbar system configuration			Selection	
e		in the base section	6	<input type="checkbox"/>
		in the lower rear section	7	
		as cable connection system	8	
		directly underneath the air circuit-breaker	9	
No system available			0	

Air circuit-breaker

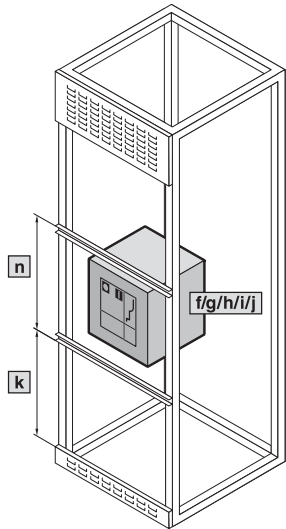
	f	Brand	ABB	A	<input type="checkbox"/>
			ABB (Emax2)	B	
			Eaton	E	
			GE	G	
			Mitsubishi	J	
			Schneider Electric	M	
			Siemens	S	
			Terasaki	T	
			Various	V	
			1/none	1	
g	Size	2	2	<input type="checkbox"/>	
		3	3		
		4	4		
		4	4		
h	Rated max.	630 A	A	<input type="checkbox"/>	
		800 A	B		
		1000 A	C		
		1250 A	D		
		1600 A	E		
		2000 A	F		
		2500 A	G		
		3200 A	H		
		4000 A ²⁾	I		
		5000 A ²⁾	J		
i	No. of poles/ version	Static installation	3-pole	3	<input type="checkbox"/>
			4-pole	4	
			3-pole with non-switched N	5	
			4-pole with non-switched N	6	
		Rack-mounted	3-pole	6	
			4-pole	8	
			3-pole with non-switched N	7	
			4-pole with non-switched N	7	
j	Position	Behind the door HT	H	<input type="checkbox"/>	
		In front of the door (in door cut-out) VT	V		
k	Compartment height underneath the circuit-breaker	0 mm	0	<input type="checkbox"/>	
		150 mm	1		
		200 mm	2		
		250 mm	3		
		300 mm	4		
		400 mm	5		
		600 mm ¹⁾	6		
		800 mm	7		
		1000 mm	8		
n	Compartment height of air circuit-breaker	600 mm ¹⁾	6	<input type="checkbox"/>	
		800 mm	7		
		1000 mm	8		

²⁾ Not available for all brands.



¹⁾ Standard height in Form 1
For Form 1 please select a **6**

Connection components for Maxi-PLS/Flat-PLS

For air circuit-breakers and busbar connections

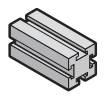
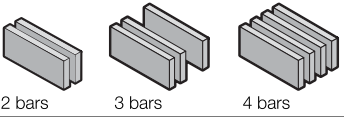
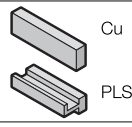
Busbar system, top

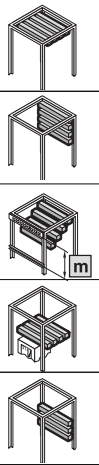
Busbar type					Selection
I	 <p>Maxi-PLS</p>	1600	3-pole	A	<input type="checkbox"/>
			4-pole	B	
		2000	3-pole	C	
			4-pole	D	
		3200	3-pole	E	
			4-pole	F	
	 <p>Flat-PLS</p>	60	3-pole	I	
			4-pole	J	
		100	3-pole	M	
			4-pole	N	
 <p>RiLine (only for T-connector kit)</p>	Cu 30 x 5/10 mm	3-pole	Q		
		4-pole	R		
	PLS 1600	3-pole	S		
		4-pole	T		
No system available					X

Busbar system configuration					Selection		
m		in the roof section		1	<input type="checkbox"/>		
		in the top rear section		2			
		as cable connection system 600 mm		3			
		as cable connection system 800 mm		8			
		as cable connection system 1000 mm		9			
		directly above the air circuit-breaker		4			
No system available					0		
o	Distribution busbar system	Distribution busbar system Type and number of poles	RiLine	Cu 30 x 5/10 mm	3-pole	Q	<input type="checkbox"/>
			RiLine	Cu 30 x 5/10 mm	4-pole	R	
			RiLine	PLS 1600	3-pole	S	
			RiLine	PLS 1600	4-pole	T	
			Distribution busbar fuse-switch disconnecter section		3-pole	E	
			Distribution busbar fuse-switch disconnecter section		4-pole	F	
p	 <p>in front of mounting plate behind mounting plate</p>	Distribution busbar system in front of or behind mounting plate	In front of mounting plate (indoor)		1	<input type="checkbox"/>	
			Behind mounting plate		2		

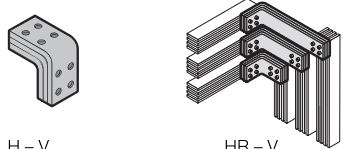
Bar configuration, busbar dimensions					Selection	
q	 <p>H - V HR - V</p> <p>H = Horizontal V = Vertical HR = Horizontal in the rear section, behind one another</p>	Maxi PLS 1600/2000		H - V	A	<input type="checkbox"/>
		Maxi PLS 1600/2000		HR - V	B	
		Maxi-PLS 3200		H - V	C	
		Maxi-PLS 3200		HR - V	D	
		up to 2 x 40 x 10		H - V	E	
		up to 2 x 60 x 10		H - V	F	
		up to 4 x 60 x 10		H - V	G	
		up to 4 x 40 x 10		H - V	H	
		up to 2 x 100 x 10		H - V	I	
		up to 4 x 80 x 10		H - V	J	
		up to 4 x 100 x 10		H - V	K	
		up to 2 x 60 x 10		HR - V	L	
		up to 4 x 60 x 10		HR - V	M	
		up to 2 x 100 x 10		HR - V	N	
		up to 4 x 100 x 10		HR - V	O	

Connection components for Maxi-PLS/Flat-PLS

For air circuit-breakers and busbar connections

Sample design code

Model No.		Enclosure			Busbar system, bottom		Air circuit-breaker						Busbar system, top		Compartment height of air circuit-breaker	Distribution busbars Type and number of poles	Distribution busbar system, in front of or behind mounting plate	Busbar configuration	Code length
		a	b	c	d	e	f	g	h	i	j	k	l	m					
9676.910	Connector kit for ACB, top	8	0	6	B	8	A	1	E	4	V	6	D	1	6				14
9676.912	Connector kit for ACB, bottom	8	0	6	B	8	A	1	E	4	V	6	D	1	6			14	
9676.200	Connection bracket above ACB	8	0	6	B	8	A	1	E	4	V	6	D	1	6			14	
9676.210	Connection bracket below ACB	8	0	6	B	8	A	1	E	4	V	6	D	1	6			14	
9675.100	T-connector kit	6	0	6	X	0										T	1	9	
9675.840	Angular connector kit	2	0	6	B	9											A	8	
9674.481	Fuse-switch-disconnector section, connection bracket	1	0	6	X	0										F		8	

Leave grey sections blank

Example of 9676.910, 9676.912, 9676.200, 9676.210
Design code: 806B8A1E4V6D16

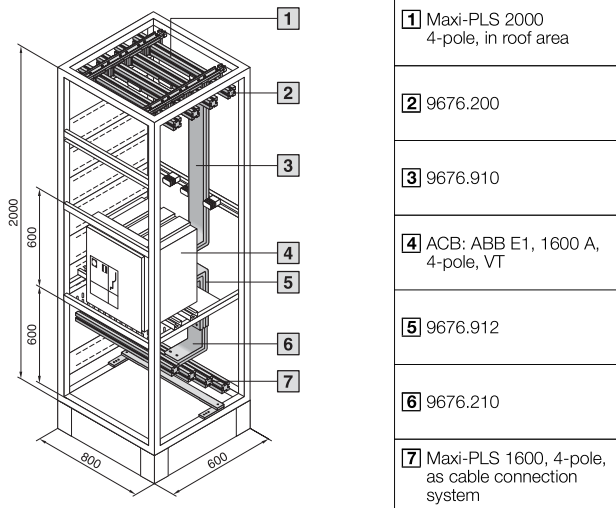

Example of 9675.100
Design code: 606X0T2T1

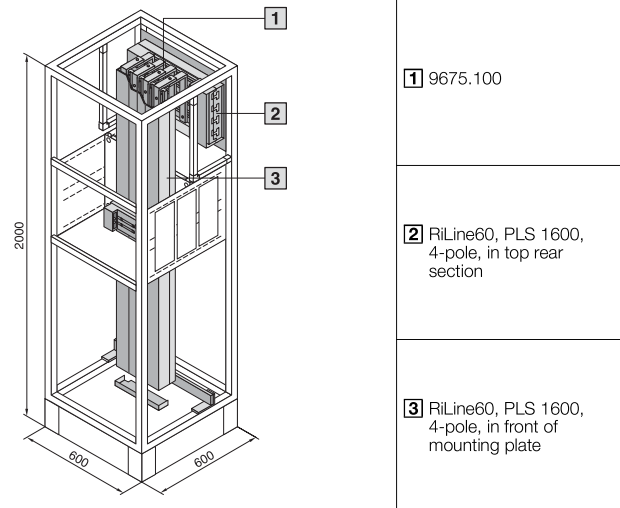

Example of 9675.840
Design code: 206B9X0A

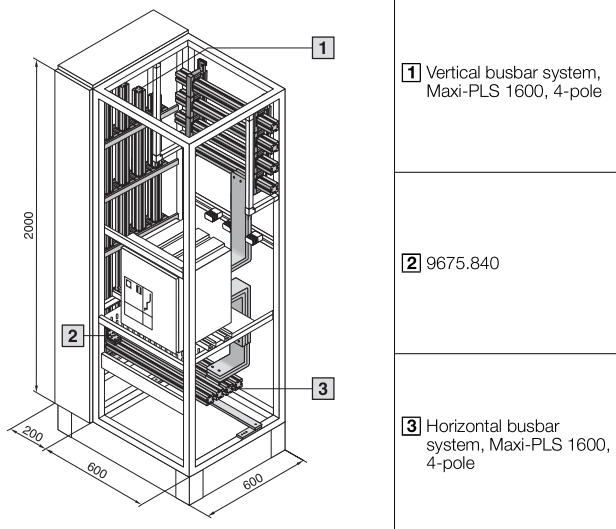

Example of 9674.481
Design code: 106X0J1F

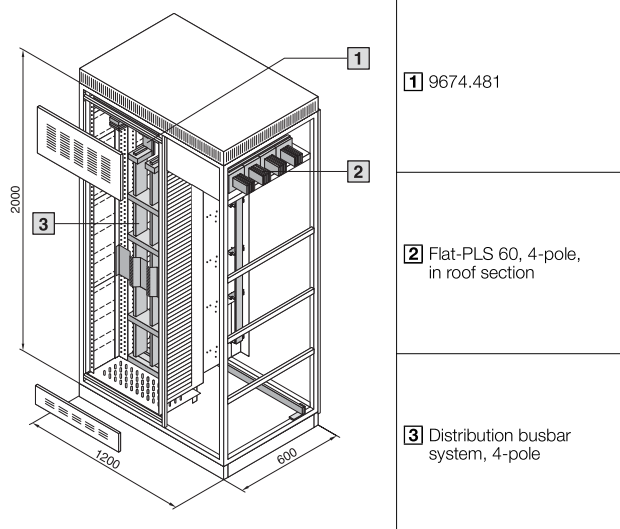

Connector kits for Maxi-PLS/Flat-PLS

System accessories



Screw connections

for connection brackets

For connecting connection brackets and a connector kit. May be used for 3- and 4-pole connector kits.

Material:

- Steel screws, zinc-plated, passivated

Supply includes:

- 8 nuts and 16 washers.

Note:

- For a bar width of 120 mm, 2 packs are required per connector kit.

For system	Screw design mm	For connection brackets width mm	No. of bars per phase	Packs of	Model No.
Maxi-PLS	M10 x 40	60 80	1	8 pc(s).	9676.966
Maxi-PLS	M10 x 60	60 80	2	8 pc(s).	9676.967
Maxi-PLS	M10 x 80	60 80	3	8 pc(s).	9676.968
Maxi-PLS Flat-PLS	M12 x 40	100 120	1	8 pc(s).	9676.961
Maxi-PLS Flat-PLS	M12 x 60	100 120	2	8 pc(s).	9676.962
Maxi-PLS Flat-PLS	M12 x 80	100 120	3	8 pc(s).	9676.963



Support rail

For attaching to the outer mounting level of the TS enclosure and for use as a cable management bar.

Material:

- Sheet steel, zinc-plated

Supply includes:

- Assembly parts

For enclosure width mm	Packs of	Model No.
600	2 pc(s).	9676.196
800	2 pc(s).	9676.198



Support set (stabiliser)

for connection kit

To support the connector kits top/bottom for air circuit-breakers (ACB).

Material:

- Stabiliser: Fibreglass-reinforced polyester
- Angle bracket: Sheet steel

Supply includes:

- 4 stabilisers
- 2 angle brackets
- Assembly parts

Packs of	Model No.
1 pc(s).	9660.205

Cover systems

Form 1

Cover plate

Slotted

To cover live parts and comply with the internal protection category IP 2X and IP XXB within low-voltage switchgear and controlgear. Integral vent holes allow convection inside a system.

Material:

- Insulating material

Width mm	Height mm	Packs of	Model No.
1200	800	1 pc(s).	9674.990



Accessories:

- Mounting bracket, see page 365

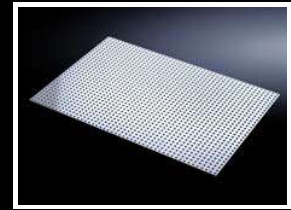

Mounting bracket

For the attachment of contact hazard protection covers. Tapped hole M6.

Material:

- Sheet steel

Surface finish:

- Zinc-plated

Supply includes:

- Assembly screws

Packs of	Model No.
24 pc(s).	9660.090

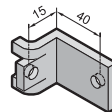

Cover systems

Form 2b



Contact hazard protection cover plate

for TS enclosures with NH slimline fuse-switch disconnectors

To cover outgoing sections with NH slimline fuse-switch disconnectors and Maxi-PLS/Flat-PLS busbar system in the rear enclosure section so that they are safe from finger contact (IP 2X).

Material:

- Sheet steel, 1.5 mm

Surface finish:

- Zinc-plated

Supply includes:

- Cover set, two-piece (top)
- Cover set, two-piece (bottom)
- Assembly parts

Note:

- The specified installation width when using Maxi-PLS only applies in conjunction with top-mountable busbar supports 9649.160/9659.160.



Blanking cover

To cover free NH slimline fuse-switch disconnector slots.

Material:

- Sheet steel, 1.5 mm

Surface finish:

- Zinc-plated

Supply includes:

- 2 cover brackets
- Assembly parts

For enclosure width mm	Free installation width when using Flat-PLS mm	Free installation width when using Maxi-PLS mm	Packs of	Model No.
600	300	500	1 pc(s).	9674.960
800	500	700	1 pc(s).	9674.980
1000	700	900	1 pc(s).	9674.900
1200	900	1100	1 pc(s).	9674.920

+ Accessories:

- Blanking cover, see page 366

Width mm	Packs of	Model No.
50	2 pc(s).	9674.905

Compartment configuration

Form 1-4

Compartment side panel module

for internal compartmentalisation

Side divider panel for compartments, for locating into the TS pitch pattern. Prepared for the location of mounting brackets for horizontal compartment dividers or mounting plates. Two TS system punchings allow the use of additional TS accessories. The side panel modules for reduced compartment depth and an auxiliary construction using TS punched rails 17 x 17 mm can be used to provide a separate enclosure space in the side panel area, e.g. for the provision of a busbar system.

Material:

- Sheet steel, 1.5 mm

Surface finish:

- Zinc-plated

Supply includes:

- Assembly parts



Accessories:

- Gland plate, see page 368
- TS punched rail 17 x 17 mm, see page 726
- Frame connector piece, see page 733
- T-connector piece, see page 734
- Corner connector, see page 734



For compartment depth mm	Height mm	With prepunched knockouts for M40 cable entries	With prepunched knockouts for gland plate, for cable entry	Packs of	Model No.
400	100	2	-	6 pc(s).	9673.041
400	150	-	2	6 pc(s).	9673.045
400	200	-	2	6 pc(s).	9673.042
400	300	-	1	2 pc(s).	9673.043
400	400	-	1	2 pc(s).	9673.044
400	600	-	3	2 pc(s).	9673.046
425	100	2	-	6 pc(s).	9673.051
425	150	-	3	6 pc(s).	9673.055
425	200	-	3	6 pc(s).	9673.052
600	100	2	-	6 pc(s).	9673.061
600	150	-	3	6 pc(s).	9673.065
600	200	-	3	6 pc(s).	9673.062
600	300	-	3	2 pc(s).	9673.063
600	400	-	3	2 pc(s).	9673.064
600	600	-	9	2 pc(s).	9673.066
800	100	2	-	6 pc(s).	9673.081
800	150	-	3	6 pc(s).	9673.085
800	200	-	3	6 pc(s).	9673.082
800	300	-	3	2 pc(s).	9673.083
800	400	-	3	2 pc(s).	9673.084
800	600	-	9	2 pc(s).	9673.086

Compartment side panel module

for cable connection space

For mounting a Maxi-PLS cable connection bar system

Material:

- Sheet steel, 2 mm

Surface finish:

- Zinc-plated

Supply includes:

- Assembly parts



Also required:

- End support for Maxi-PLS, see page 354



For enclosure depth mm	Height mm	For system	Packs of	Model No.
600	450	Maxi-PLS 1600, 3/4 pole Maxi-PLS 2000, 3/4 pole Maxi-PLS 3200, 3-pole	2 pc(s).	9673.069
800	450	Maxi-PLS 1600, 3/4 pole Maxi-PLS 2000, 3/4 pole Maxi-PLS 3200, 3/4 pole	2 pc(s).	9673.089

Compartment configuration

Form 1-4



Gland plate for compartment side panel modules (internal compartmentalisation)

For closing cable entries.

Material:

- PVC, 3 mm
- Fire protection corresponding to UL 94-V0

Colour:

- RAL 7004

Supply includes:

- Assembly parts

For side panel module height mm	Packs of	Model No.
150	10 pc(s).	9673.195
200 600	10 pc(s).	9673.192
300	4 pc(s).	9673.193
400	4 pc(s).	9673.194



Terminal box Form 4b

for modular outgoing section

For shielding the connections (terminals) of the compartment, busbar space and cable chamber in accordance with Form 4b to IEC 61 439-2. The terminal boxes are externally mounted on the compartment side panel modules (for internal compartmentalisation) in the cable chamber to match the heights of the compartments. If necessary, a clamping strip may be mounted on the cable retainer included with the supply.

Material:

- Sheet steel, 1.5 mm

Surface finish:

- Zinc-plated

Supply includes:

- Assembly parts

Note:

- For installation of the terminal boxes, the width of the cable chamber must be at least 400 mm

For enclosure width mm	For compartment height mm	Packs of	Model No.
400 600	150	1 pc(s).	9674.701
400 600	200	1 pc(s).	9674.702
400 600	300	1 pc(s).	9674.703
400 600	400	1 pc(s).	9674.704
400 600	600	1 pc(s).	9674.706



Also required:

- Compartment side panel module, see page 367

Compartment configuration

Form 1-4

Compartment divider

For the horizontal separation of compartments. In combination with the side panel modules, this creates Form separation in accordance with Form 3 or 4.

Design:

- with vents

Material:

- Sheet steel, 1.25 mm

Surface finish:

- Zinc-plated



Also required:

- Mounting bracket for compartment divider, see page 371
- Mounting bracket for compartment divider and air circuit-breaker support rail, see page 371



Assembly instruction:

- 2 mounting brackets are required to install each compartment divider.

For enclosure width mm	For compartment depth mm	Width mm	Depth mm	Packs of	Model No.
400	400	306	370	4 pc(s).	9673.443
400	425	306	445	4 pc(s).	9673.444
400	600	306	588	4 pc(s).	9673.445
400	800	306	788	4 pc(s).	9673.448
600	400	506	370	4 pc(s).	9673.463
600	425	506	445	4 pc(s).	9673.464
600	600	506	588	4 pc(s).	9673.465
600	800	506	788	4 pc(s).	9673.468
800	400	706	370	4 pc(s).	9673.483
800	425	706	445	4 pc(s).	9673.484
800	600	706	588	4 pc(s).	9673.485
800	800	706	788	4 pc(s).	9673.488

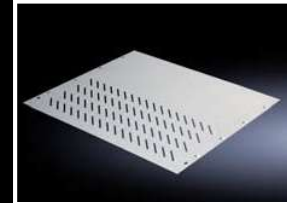

Compartment divider

for RiLine busbar systems

For the horizontal separation of compartments with integral RiLine distribution busbar system. In combination with the side panel modules, this creates Form separation in accordance with Form 3 or 4.

Design:

- with vents

Material:

- Sheet steel, 1.25 mm

Surface finish:

- Zinc-plated

For enclosure width mm	For compartment depth mm	Width mm	Depth mm	Packs of	Model No.
600	400	506	413	4 pc(s).	9673.454



Also required:

- Mounting bracket, see page 371



Assembly instruction:

- 2 mounting brackets for compartment dividers are required for each installation.

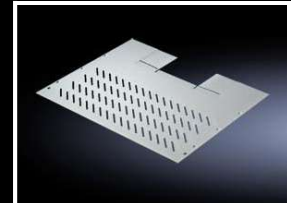

Compartment configuration

Form 1-4

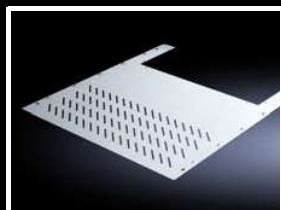

Compartment divider

with duct for vertical busbar systems

For the horizontal separation of compartments with vertical busbars. In combination with the side panel modules, this creates Form separation in accordance with Form 3 or 4.

Design:

- with vents

Material:

- Sheet steel, 1.25 mm

Surface finish:

- Zinc-plated



Also required:

- Gland plate, see page 370
- Mounting bracket for compartment divider, see page 371
- Mounting bracket for compartment divider and air circuit-breaker support rail, see page 371



Assembly instruction:

- 2 mounting brackets are required to install each compartment divider.

For enclosure width mm	For compartment depth mm	Width mm	Depth mm	Width of entry mm	Depth of entry mm	Packs of	Model No.
400	600	306	588	212	201	4 pc(s).	9673.436
400	800	306	788	212	201	4 pc(s).	9673.438
600	600	506	588	412	201	4 pc(s).	9673.456
600	800	506	788	412	201	4 pc(s).	9673.458
800	600	706	588	612	201	4 pc(s).	9673.476
800	800	706	788	612	201	4 pc(s).	9673.478



Gland plate

for compartment divider with duct

To shroud the opening for vertical busbar systems.

Material:

- ABS PMMA

For enclosure width mm	Width mm	Height mm	Packs of	Model No.
400	250	223.5	4 pc(s).	9673.504
600	450	223.5	4 pc(s).	9673.506
800	650	223.5	4 pc(s).	9673.508



Air circuit-breaker support bar

For the configuration of air circuit-breakers (ACB) in compartments.

Material:

- Sheet steel, 2.5 mm

Surface finish:

- Zinc-plated

Supply includes:

- Assembly parts

For enclosure width mm	Length mm	Packs of	Model No.
400	351	2 pc(s).	9673.004
600	551	2 pc(s).	9673.006
800	751	2 pc(s).	9673.008



Also required:

- Mounting bracket, see page 371
- Attachment set, see page 371



Compartment configuration

Form 1-4

Mounting bracket

for compartment divider

The mounting bracket may be attached to a TS frame, to a side panel module or between a frame section and an auxiliary construction. Pre-machined mounting openings allow slide-in attachment of compartment dividers.

Material:

- Sheet steel, 1.5 mm

Surface finish:

- Zinc-plated

Supply includes:

- Assembly parts

For compartment depth mm	Length mm	Packs of	Model No.
400	352	8 pc(s).	9673.404
425	427	8 pc(s).	9673.405
600	552	8 pc(s).	9673.406
800	752	8 pc(s).	9673.408



Mounting bracket

for compartment divider and air circuit-breaker support rail

The mounting bracket is secured to the side panel module. Pre-machined mounting openings allow slide-in attachment of functional space dividers. The air circuit-breaker support bar may be attached to the upper level.

Material:

- Sheet steel, 2 mm

Surface finish:

- Zinc-plated

Supply includes:

- Assembly parts

For compartment depth mm	Length mm	Packs of	Model No.
600	552	2 pc(s).	9673.426
800	752	2 pc(s).	9673.428



Attachment set

for air circuit-breaker installation

For attaching air circuit-breakers (ACB) to air circuit-breaker support bars.

Material:

- Steel

Surface finish:

- Zinc-plated

Supply includes:

- 4 threaded plates (M8/M12)

Packs of	Model No.
1 pc(s).	9660.970



Compartment configuration

Form 1-4



Partial mounting plates

for compartment side panel modules (internal compartmentalisation)

For direct attachment to the compartment side panel modules for internal compartmentalisation. Universal interior installation with switchgear and controlgear. Creation of additional mounting levels. In combination with compartment dividers and side panel modules, internal compartmentalisation in accordance with Form 2, 3 or 4 is possible.

Material:

- Sheet steel, 2 mm

Surface finish:

- Zinc-plated

Supply includes:

- Angle brackets and assembly parts



Also required:

- Compartment side panel module, see page 367

Design with gland made from insulating material

For enclosure width mm	For compartment height mm	Width mm	Height mm	Packs of	Model No.
600	150	502	143	1 pc(s).	9673.671
600	200	502	193	1 pc(s).	9673.672
600	300	502	293	1 pc(s).	9673.673
600	400	502	393	1 pc(s).	9673.674
800	200	702	193	1 pc(s).	9673.692
800	300	702	293	1 pc(s).	9673.693
800	400	702	393	1 pc(s).	9673.694

Design without duct

For enclosure width mm	For compartment height mm	Width mm	Height mm	Packs of	Model No.
400	200	302	193	1 pc(s).	9673.642
400	300	302	293	1 pc(s).	9673.643
400	400	302	393	1 pc(s).	9673.644
400	600	302	593	1 pc(s).	9673.646
400	800	302	793	1 pc(s).	9673.648
600	150	502	143	1 pc(s).	9673.661
600	200	502	193	1 pc(s).	9673.662
600	300	502	293	1 pc(s).	9673.663
600	400	502	393	1 pc(s).	9673.664
600	600	502	593	1 pc(s).	9673.666
600	800	502	793	1 pc(s).	9673.668
600	1000	502	993	1 pc(s).	9673.660
800	150	702	143	1 pc(s).	9673.681
800	200	702	193	1 pc(s).	9673.682
800	300	702	293	1 pc(s).	9673.683
800	400	702	393	1 pc(s).	9673.684
800	600	702	593	1 pc(s).	9673.686
800	800	702	793	1 pc(s).	9673.688
800	1000	702	993	1 pc(s).	9673.680

Compartment configuration

Form 1-4

Support frame

for DIN rail-mounted devices

Support frame set for accepting DIN rail-mounted devices (e.g. MCBs). The support rails are fastened with two mounting brackets to the side panel modules for internal compartmentalisation. The cover is fastened to the support frame with knurled screws. In combination with compartment dividers, partial mounting plates and side panel modules, internal compartmentalisation in accordance with Form 2, 3 or 4 is possible.

Material:

- Support frame: Sheet steel, zinc-plated, passivated, 1.5 mm
- Cover: Sheet steel, spray finished, 1.5 mm

Supply includes:

- Support rails
- 2 mounting brackets
- 1 cover with cut-out
- Assembly parts

For enclosure width mm	For compartment height mm	No. of pitch units 17.5 mm	Packs of	Model No.
600	150	1 x 24	1 pc(s).	9674.761
600	300	2 x 24	1 pc(s).	9674.762
800	300	2 x 36	1 pc(s).	9674.782



Also required:

- Compartment side panel module, see page 367



Accessories:

- Compartment divider, see page 369
- Partial mounting plates, see page 372



Coupling set mounting kit

for busbar enclosure or riser

The mounting kit is used as a base support for a vertical Maxi-PLS busbar system/Flat-PLS busbar system.

Material:

- Sheet steel

Surface finish:

- Zinc-plated

Supply includes:

- Mounting plate
- 2 punched sections with mounting flanges
- Assembly parts

Design for Flat-PLS busbar system

For enclosure width mm	For enclosure depth mm	Product-specific scope of supply	Packs of	Model No.
400	600	Gland plate	1 pc(s).	9674.046
400	800	Gland plate	1 pc(s).	9674.048

Design for Maxi-PLS busbar system

For enclosure width mm	For enclosure depth mm	Product-specific scope of supply	Packs of	Model No.
200	600	-	1 pc(s).	9674.196
200	800	-	1 pc(s).	9674.198



Also required:

- End support for Maxi-PLS, see page 354



Ri4Power accessories

Busbar system



System attachments

for RiLine main busbar system

System attachment with threaded holes M5 and M6 on a 50 mm pitch pattern for rear assembly of a RiLine main busbar system. For locating into the TS frame.

Material:

– Sheet steel

Surface finish:

– Zinc-plated

Supply includes:

– Assembly parts

Note:

– RiLine busbar systems, see page 265

For enclosure width mm	Width mm	Height mm	P. of	Model No.
400	338.5	362	1 pc(s).	9674.004
600	538.5	362	1 pc(s).	9674.006
800	738.5	362	1 pc(s).	9674.008



Distribution busbars

Prepared for the connection of T-connector kits.

Material:

– E-Cu

Flat busbar Cu 30 x 10 mm

For distribution busbar systems behind the compartment	For distribution busbar systems in the compartment (indoors)	P. of	Length mm	Model No.
For enclosure height mm				
2000	–	1 pc(s).	1410	9675.210
2200	1800 ¹⁾	1 pc(s).	1610	9675.212
–	2000 ¹⁾	1 pc(s).	1810	9675.220

¹⁾ Also suitable as a vertical busbar for PE/PEN/N

PLS 1600

For distribution busbar systems behind the compartment	For distribution busbar systems in the compartment (indoors)	P. of	Length mm	Model No.
For enclosure height mm				
2000	–	1 pc(s).	1350	9675.230
2200	1800 ¹⁾	1 pc(s).	1550	9675.232
–	2000 ¹⁾	1 pc(s).	1750	9675.240
–	2200 ¹⁾	1 pc(s).	1950	9675.242

¹⁾ Also suitable as a vertical busbar for PE/PEN/N



Copper spacer rolls

for Maxi-PLS busbars and flat copper bars

For use as a universal spacer.

Height: 20 mm

Hole diameter: 13 mm

Material:

– E-Cu

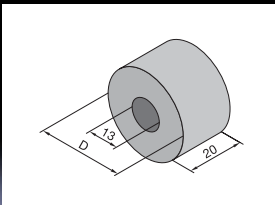

Diameter (D) mm	For connecting						P. of	Model No.
	Cu bar – Cu bar		Maxi-PLS – Cu bar		Flat-PLS – Cu bar			
	Cross-section size mm ²	Rated max. current A	Contact area mm ²	Rated max. current A	Contact area mm ²	Rated max. current A		
30	550	1100	360	800	380	850	4 pc(s).	9676.503
40	1100	2200	780	1600	670	1400	4 pc(s).	9676.504
50	1800	3400	1380	2800	990	2000	4 pc(s).	9676.505

Ri4Power accessories

Fuse-switch disconnecter section

Busbar support

for fuse-switch disconnecter section

Busbar support for the distribution busbar system of the fuse-switch disconnecter section.

Material:

- Duroplastic polyester

Supply includes:

- Mounting bracket and screws

For busbars mm	Number of poles	Packs of	Model No.
50 x 10	3-pole 4-pole	1 pc(s).	9674.415
60 x 10	3-pole 4-pole	1 pc(s).	9674.416
80 x 10	3-pole 4-pole	1 pc(s).	9674.418
100 x 10	3-pole 4-pole	1 pc(s).	9674.410



Also required:

- End support, see page 375
- Distribution busbars, see page 375



End support

for fuse-switch disconnecter section

End support for the distribution busbar system of the fuse-switch disconnecter section, for vertical support of the distribution busbar system with infeed from above.

Material:

- Duroplastic polyester

Supply includes:

- Mounting bracket and screws

For busbars mm	Number of poles	Packs of	Model No.
50 x 10	3-pole 4-pole	1 pc(s).	9674.435
60 x 10	3-pole 4-pole	1 pc(s).	9674.436
80 x 10	3-pole 4-pole	1 pc(s).	9674.438
100 x 10	3-pole 4-pole	1 pc(s).	9674.430



Also required:

- Distribution busbars, see page 375



Distribution busbars

for fuse-switch disconnecter section

Distribution busbar to fit the main busbar systems Maxi-PLS and Flat-PLS for installation in the fuse-switch disconnecter sections.

Material:

- E-Cu

For enclosure height mm	Dimensions mm	Length mm	Packs of	Model No.
2000	50 x 10	1632.5	1 pc(s).	9674.405
2000	60 x 10	1632.5	1 pc(s).	9674.406
2000	80 x 10	1632.5	1 pc(s).	9674.408
2000	100 x 10	1632.5	1 pc(s).	9674.400

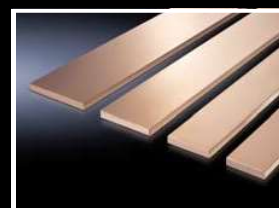

Ri4Power accessories

Fuse-switch disconnecter section



Cover

Set for distribution busbar (Jean Müller fuse-switch disconnecter section)

To cover the distribution busbar system of a fuse-switch disconnecter section, designed to accommodate Jean Müller devices. The 150 mm high busbar and cable connection space covers shield the busbar compartment from the functional space so that it is safe from finger contact, with a protection category of IP 20.

Material:

- PVC, black

Supply includes:

- Set consisting of 12 busbar covers and cable connection space covers

For enclosure height mm	Packs of	Model No.
2000 2200	1 pc(s).	9674.380



Also required:

- Punched rail, see page 376

Punched rail

Set for cover, distribution busbar (Jean Müller fuse-switch disconnecter section)

Required for mounting the distribution busbar cover.

Material:

- Sheet steel, zinc-plated

Supply includes:

- Set consisting of 2 punched rails

Note:

- For 1 fuse-switch disconnecter section, 1 pack of punched rails is required.

For enclosure height mm	Packs of	Model No.
2000 2200	1 pc(s).	9674.381

Ri4Power accessories

Fuse-switch-disconnector section/software

Cover

for distribution busbar (ABB/Siemens fuse-switch-disconnector section)

To cover the distribution busbar system of a fuse-switch-disconnector section, designed to accommodate ABB (SlimLine) or Siemens (3NJ62) devices. The 200 mm high busbar compartment covers shield the busbar compartment from the functional space so that it is safe from finger contact, with a protection category of IP 20.

Material:

- PVC, black

Note:

- The cover may be ordered from ABB under order number NHP 407062R000X.
- For enclosure height 2000 mm, a height of 1500 mm should be covered, and for enclosure height 2200 mm, a height of 1700 mm should be covered.



Rittal Power Engineering

Planning software for RiLine busbar systems and Ri4Power low-voltage switchgear with design verification

The multi-lingual software package includes the following functions:

- Project handling, from the initial enquiry through to ordering
- Configuration of RiLine busbar systems in the TS enclosure, compact enclosure AE, CM, KS and free-standing enclosure SE.
- Configuration of low-voltage switchgear with Ri4Power systems Form 1-4 and ISV
- Fully automated generation of complete bills of materials and a calculation program for quote preparation
- Input and evaluation of assembly times to calculate man hours
- Access to the entire range of Rittal products
- Output of automatically generated system documentation with rated current and heat loss calculation

P. of	Model No.
1 pc(s).	3020.500

- Generation of special fields configured by the customer with graphical processing in the CAD view
- Import/export interfaces for product and CAD data
- Export function for order lists and bills of materials in Excel format
- Interface to EPLAN Electric P8, for the export of CAD data and bills of materials
- The extra benefit for engineering and planning offices: Output of detailed tender texts based on systems that have been project-planned in Power Engineering in MS Word format
- Output of project-specific assembly plans together with field and plant definitions
- Integral configurator for the generation of drawings and bills of materials to create connector kits for connecting air circuit-breakers (ACB)
- Simple generation of the design verification to IEC 61 439

Supply includes:

- DVD-ROM
Languages: German/English/French/Dutch/
Danish/Swedish/Czech/Italian/Spanish/Polish/
Russian/Chinese

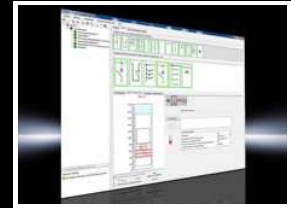

Rittal – The System.

Faster – better – everywhere.



Ri4Power ISV distribution enclosures

Distribution enclosures

- Based on baying system TS 8, see page 88
- Based on baying system SE 8, see page 94
- Mounting kits, see page 380

Wall-mounted distributors

- Based on compact enclosure AE, see page 58
- Mounting kits, see page 380

Installation modules

- Easy mounting on support frame or support plate
- Individual combination and configuration
- Pitch pattern 150 x 250 mm
- Installation modules, see page 381

Power distribution components

- Bus-mounting fuse bases, see page 289
- NH fuse-switch disconnectors, see page 291
- NH slimline fuse-switch disconnectors, see page 301



ISV distribution enclosures

Mounting kits



Installation kit

for TS

For mounting ISV installation modules in TS enclosures.

Supply includes:

- Mounting aid support
- Contact hazard protection
- Assembly parts



Accessories:

- Cross rail, see page 387
- Mounting angle, see page 387
- Depth stay, see page 387
- Equipment support connectors, see page 387

For enclosure width mm	600	600	850	1100
For enclosure height mm	1800	2000	2000	2000
For enclosure depth mm	400 500 600	400 600	400 600	400 600
To fit Model No.	8457.600/8684.500/ 8685.500/8686.500	8452.600/8604.500/ 8606.500	9666.915/9666.955	9666.925/9666.965
Width units (WU) @ 250 mm	2	2	3	4
Height units (U) @ 150 mm	11	12	12	12
Note on Model No.	Mounting angle 9666.711 additionally required	Mounting angle 9666.712 additionally required	Mounting angle 9666.712 additionally required	Mounting angle 9666.712 and depth stay 9666.731 additionally required
Packs of	1 pc(s).	1 pc(s).	1 pc(s).	1 pc(s).
Model No.	9666.931	9666.901	9666.911	9666.921



Installation kit

for AE

For mounting ISV installation modules in AE enclosures.

Supply includes:

- Assembly kit
- Support rails
- Contact hazard protection
- Assembly parts



Accessories:

- Mounting angle, see page 387

For enclosure width mm	380	500	600	600	600	1000
For enclosure height mm	600	700	760	1000	1200	1200
For enclosure depth mm	210	250	210	250	300	300
To fit Model No.	1008.600/ 1038.500	1057.500	1012.600/ 1076.500	1090.500	1260.500	1019.500/ 1019.600/ 1213.500
Width units (WU) @ 250 mm	1	1	2	2	2	3
Height units (U) @ 150 mm	3	4	4	6	7	7
Packs of	1 pc(s).	1 pc(s).	1 pc(s).	1 pc(s).	1 pc(s).	1 pc(s).
Model No.	9666.801	9666.811	9666.821	9666.831	9666.841	9666.851

ISV distribution enclosures

Installation modules

1 Contact hazard protection modules

- For covering free installation areas
- Cover is prepared for a lead seal

Material:
– Cover: Polystyrene (PS)

Colour:
– RAL 7035

2 Mounting plate modules

- With mounting plate made from 2 mm zinc-plated sheet steel
- Cover is prepared for a lead seal
- Possible installation depth 105 – 140 mm

Size				P. of	1 Contact hazard protection		2 Mounting plate	
Width unit		Height unit			Interior installation	Model No.	Dimensions of mounting plate mm	
WU	mm	U	mm				Model No.	Model No.
1	250	1	150	Empty module		9666.000	188 x 116	9666.080
1	250	2	300			9666.010	188 x 266	9666.090
1	250	3	450			9666.020	188 x 416	9666.100
1	250	4	600			9666.030	188 x 566	9666.110
2	500	1	150			9666.040	438 x 116	9666.120
2	500	2	300			9666.050	438 x 266	9666.130
2	500	3	450			9666.060	438 x 416	9666.140
2	500	4	600			9666.070	438 x 566	9666.150
3	750	2	300			9666.053	688 x 266	9666.133
3	750	3	450			9666.063	688 x 416	9666.143
3	750	4	600			9666.073	–	–

1 WU \geq 250 mm
1 U \geq 150 mm



1 Support rail modules

- For installing terminal blocks, switchgear, etc.
- Support rails 35/15 mm
- Adjustable on a 25 mm pitch pattern
- Cover is prepared for a lead seal

Material:
– Cover: Polystyrene (PS)

Colour:
– RAL 7035

+ **Accessories:**

– Cover strips for DIN rail mounted device modules, see page 386

2 DIN rail mounted device modules

- To accommodate DIN rail mounted devices
- Support rails 35/15 mm
- Cover is prepared for a lead seal

Size				P. of	1 Support rails		2 DIN rail mounted devices	
Width unit		Height unit			Number of support rails	Model No.	Mechanical interior installation ¹⁾	
WU	mm	U	mm				Model No.	Model No.
1	250	1	150	1 pc(s).	1	9666.160	12 pitch units (1 x 12 x 18 mm)	9666.240
1	250	2	300	1 pc(s).	2	9666.170	24 pitch units (2 x 12 x 18 mm)	9666.250
1	250	3	450	1 pc(s).	3	9666.180	36 pitch units (3 x 12 x 18 mm)	9666.260
1	250	4	600	1 pc(s).	4	9666.190	48 pitch units (4 x 12 x 18 mm)	9666.270
2	500	1	150	1 pc(s).	1	9666.200	24 pitch units (2 x 12 x 18 mm)	9666.280
2	500	2	300	1 pc(s).	2	9666.210	48 pitch units (4 x 12 x 18 mm)	9666.290
2	500	3	450	1 pc(s).	3	9666.220	72 pitch units (6 x 12 x 18 mm)	9666.300
2	500	4	600	1 pc(s).	4	9666.230	–	–
3	750	2	300	1 pc(s).	2	9666.213	72 pitch units (6 x 12 x 18 mm)	9666.293
3	750	3	450	1 pc(s).	3	9666.223	108 pitch units (9 x 12 x 18 mm)	9666.303

1 WU \geq 250 mm
1 U \geq 150 mm
¹⁾ No. of panels x pitch units x width



ISV distribution enclosures

Installation modules



Connection terminal blocks

- For connecting copper and aluminium conductors
- Single-wire or multi-wire conductors with crimped wire end ferrule or laminated copper bar

Material:
– Duroplastic

Colour:
– RAL 7035

Version	Connection of round conductors mm ²	Clamping area for laminated copper bars, W x H mm	P. of	Model No.	Page
1 250 A, 5-pole	1 x 16 – 150 or 2 x 16 – 70	17 x 21	1 pc(s).	9666.340	
400 A, 5-pole	1 x 50 – 240 or 2 x 25 – 120	25 x 21	1 pc(s).	9666.350	

Also required

Description	Size				P. of	Model No.	Page
	Width unit		Height unit				
	WU	mm	U	mm			
2 Mounting kit for connection terminal block	1	250	3	450	1 pc(s).	9666.310	
Contact hazard protection modules	1	250	3	450	1 pc(s).	9666.020	381

Accessories

Laminated copper bars		311
1 WU \geq 250 mm		
1 U \geq 150 mm		

NH fuse-switch-disconnector modules

- Suitable for accommodating NH fuse-switch disconnectors for mounting plate assembly
- Cover is prepared for a lead seal

Material:
– Cover: Polystyrene (PS)

Colour:
– RAL 7035

Note:
– Blanking cover 9666.665 should be used to seal unneeded cut-outs for NH fuse-switch disconnectors size 00.

To fit NH disconnector		Size				P. of	Model No.	Page
Size	Model No.	Width unit		Height unit				
		WU	mm	U	mm			
2 pc(s), size 00	9344.000/.010/	1	250	2	300	1 pc(s).	9666.380	
4 pc(s), size 00	.020/.030/.040/.050	2	500	2	300	1 pc(s).	9666.390	
1 pc(s), size 1	9344.100/.110/	1	250	3	450	1 pc(s).	9666.400	
	.130/.150							
1 pc(s), size 2	9344.200/.210/	1	250	3	450	1 pc(s).	9666.410	
	.230/.250							
1 pc(s) size 3 or	9344.300/.310/	2	500	3	450	1 pc(s).	9666.060 ¹⁾	381
2 pc(s) size 2	.330/.350					1 pc(s).	9666.420 ¹⁾	382

1 WU \geq 250 mm
1 U \geq 150 mm

¹⁾ Module unit consisting of disconnector cross-member 9666.420 and contact hazard protection module 9666.060

Disconnector cross-member

for NH fuse-switch disconnector, size 2/3

- Suitable for the accommodation of NH fuse-switch disconnectors for mounting plate assembly

To fit NH disconnector		Size				P. of	Model No.	Page
Size	Model No.	Width unit		Height unit				
		WU	mm	U	mm			
1 pc(s), size 3 or	9344.300/.310/	2	500	3	450	1 pc(s).	9666.420	
2 pc(s), size 2	.330/.350							

Also required

Contact hazard protection modules		1 pc(s).	9666.060	381
-----------------------------------	--	----------	----------	-----

ISV distribution enclosures

Installation modules

NH slimline fuse-switch disconnecter modules

For NH slimline fuse-switch disconnecters, sizes 00 to 3 (100/185 mm bar centre distance).

Material:

– Cover: Polystyrene (PS)

Colour:

– RAL 7035

Note:

- Busbars are not included with the supply
- In order to ensure problem-free cable connection, a contact hazard protection module or an N/PE busbar module must be installed above or below the NH slimline fuse-switch disconnecter modules



Version	To fit NH slimline fuse-switch disconnecters Model No.	Size				P. of	Model No.	Page
		Width unit		Height unit				
		WU	mm	U	mm			
100 mm module, 3-pole, max. 3 x size 00	9346.020 9346.030	1	250	3	450	1 pc(s).	9666.570	
100 mm module, 3-pole, max. 6 x size 00		2	500	3	450	1 pc(s).	9666.580	
100 mm module, 3-pole, max. 10 x size 00		3	750	3	450	1 pc(s).	9666.583	
185 mm module, 3-pole, max. 8 x size 00/ 4 x size 1, 2, 3	9677.XXX	2	500	5	750	1 pc(s).	9666.550	
185 mm module, 3-pole, max. 12 x size 00/ 6 x size 1, 2, 3		3	750	5	750	1 pc(s).	9666.560	

Also required

Contact hazard protection modules	381
Busbar modules N/PE	384

1 WU \triangleq 250 mm
1 U \triangleq 150 mm

Air circuit-breaker modules

- Suitable for accommodating standard circuit-breakers from ABB, Eaton, Schneider Electric and Siemens
- Cover is prepared for a lead seal

Material:

– Cover: Polystyrene (PS)

Colour:

– RAL 7035

Note:

- Attachment of the air circuit-breakers and the corresponding cut-out dimensions for the cover are shown in the enclosed assembly instructions
- Air circuit-breakers are not included with the supply



For air circuit-breakers	Size				P. of	Model No.
	Width unit		Height unit			
	WU	mm	U	mm		
up to 250 A	1	250	2	300	1 pc(s).	9666.430
up to 630 A	2	500	3	450	1 pc(s).	9666.440

1 WU \triangleq 250 mm
1 U \triangleq 150 mm

ISV distribution enclosures

Installation modules



Meter mounting board module

- Open module for internal measurements
- Clearance depth available for meter installation 170 mm

Material:

- Meter mounting board: Polystyrene (PS)

Colour:

- RAL 7035

Note:

- The meter mounting board module does not comply with meter mounting board standard DIN 43 870/VDE 0603 and does not meet the conditions for total insulation. Use in unmetred areas only by arrangement with the local electricity supply company.
- 1 contact hazard protection module / DIN rail mounted device module or support rail module with 1 WU and at least 1 U is required both above and below the module.

Size				P. of	Model No.	Page
Width unit		Height unit				
WU	mm	U	mm			
1	250	3	450	1 pc(s).	9666.640	

Also required

Contact hazard protection modules	381
Support rail modules	381
DIN rail mounted device modules	381

- 1 WU $\hat{=}$ 250 mm
- 1 U $\hat{=}$ 150 mm



Busbar modules N/PE

- For attaching the busbars for N and PE
- Cover is prepared for a lead seal

Material:

- Cover: Polystyrene (PS)

Colour:

- RAL 7035

Note:

- Copper or CUPONAL busbars should be ordered separately, see page 307/308
- Not suitable for use in mounting kit AE

For busbars mm	Size				P. of	Model No.
	Width unit		Height unit			
	WU	mm	U	mm		
12 x 5 to 30 x 10 mm	1	250	2	300	1 pc(s).	9666.590
	2	500	2	300	1 pc(s).	9666.600
	3	750	2	300	1 pc(s).	9666.603

- 1 WU $\hat{=}$ 250 mm
- 1 U $\hat{=}$ 150 mm

ISV distribution enclosures

Installation modules

Busbar modules

For assembling bus-mounting fuse bases E18, E27, E33 and D-Switch as well as NH fuse-switch disconnectors sizes 000 and 00 (3-pole, 60 mm bar centre distance).

Material:

– Cover: Polystyrene (PS)

Colour:

– RAL 7035

Note:

– Busbars are not included with the supply



Size				To fit		P. of	Model No.	Page
Width unit		Height unit		Fusible elements	NH disconnectors			
WU	mm	U	mm	Model No.	Model No.			
1	250	2	300	3418.010 3427.010 3433.010 9340.950	9343.000 ¹⁾ 9343.020 ¹⁾ 9343.040 ¹⁾ 3431.020 3431.030 3431.035	1 pc(s).	9666.520	
2	500	2	300		3431.020 3431.030 3431.035	1 pc(s).	9666.530	
3	750	2	300		3431.020 3431.030 3431.035	1 pc(s).	9666.533	

Accessories

Blanking cover						10 pc(s).	9666.660	386
----------------	--	--	--	--	--	-----------	----------	-----

1 WU $\hat{=}$ 250 mm

1 U $\hat{=}$ 150 mm

¹⁾ A depth extension frame 9666.680 should additionally be used to ensure unrestricted connection.
NH fuse-switch disconnectors size 00 cannot be combined with other equipment.

ISV distribution enclosures

Accessories

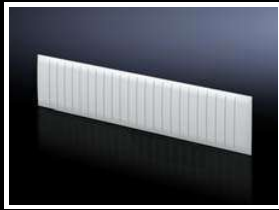

Cover strips

for DIN rail mounted device modules

For sealing unused component cut-outs in DIN rail mounted device modules, max. 12 pitch units (12 x 18 mm), divisible every 9 mm.

Material:

– ABS

Colour:

– RAL 7035

P. of	Model No.
5 pc(s).	9666.650



Blanking cover

- For sealing unused cut-outs
- To fit bus-mounting fuse base, D-Switch and NH fuse-switch disconnecter size 000 (3-pole, 60 mm busbar systems) in busbar modules (9666.520/.530/.533)
- Width: 16 – 34 mm variable

Material:

– Polypropylene (PP)

Colour:

– RAL 7035

P. of	Model No.
10 pc(s).	9666.660



Blanking cover

for disconnectors, size 00

- For sealing unused cut-outs with NH fuse-switch disconnectors size 00 in NH fuse-switch disconnecter modules (9666.380/.390)
- Width: 117 mm

Material:

– PVC

Colour:

– RAL 7035

P. of	Model No.
1 pc(s).	9666.665



Wiring brackets

For tool-free external mounting on support rails TS 35/15 for cable routing on the rear of support rail modules.

Material:

– Polyamide (PA 6.6)

P. of	Model No.
10 pc(s).	9666.670



Depth extension frame

For extending the depth of the contact hazard protection cover. Allows unrestricted connection of NH fuse-switch disconnectors, size 00 (3-pole, 60 mm busbar systems).

Material:

– Polystyrene (PS)

Colour:

– RAL 7035

Size				P. of	Model No.
Width unit		Height unit			
WU	mm	U	mm		
1	250	2	300	1 pc(s).	9666.680

1 WU \triangleq 250 mm
1 U \triangleq 150 mm

Note:

- NH fuse-switch disconnectors size 00 with covers and depth extension frame cannot be used in conjunction with other equipment.

ISV distribution enclosures

Accessories

Cross rails

for TS, SE

For horizontal sub-division of the support frame in the TS/SE enclosure.

Material:

– Sheet steel

Surface finish:

– Zinc-plated

Width unit		P. of	Model No.
WU	mm		
2	500	2 pc(s).	9666.722
3	750	2 pc(s).	9666.723
4	1000	2 pc(s).	9666.724

1 WU \pm 250 mm



Mounting angles

for TS, SE

For vertical sub-division of the support frame in the TS/SE enclosure.

Material:

– Sheet steel

Surface finish:

– Zinc-plated

Height unit		P. of	Model No.
U	mm		
2	300	2 pc(s).	9666.702
3	450	2 pc(s).	9666.703
4	600	2 pc(s).	9666.704
5	750	2 pc(s).	9666.705
6	900	2 pc(s).	9666.706
7	1050	2 pc(s).	9666.707
11	1650	2 pc(s).	9666.711
12	1800	2 pc(s).	9666.712

1 U \pm 150 mm



Accessories:

– Equipment support connector, see page 387

Mounting angles

for AE

For vertical sub-division of the support frame in the AE enclosure.

Material:

– Sheet steel

Surface finish:

– Zinc-plated

Height unit		P. of	Model No.
U	mm		
3	450	2 pc(s).	9666.753
4	600	2 pc(s).	9666.754
6	900	2 pc(s).	9666.756
7	1050	2 pc(s).	9666.757

1 U \pm 150 mm



Depth stay

For installation kits ISV

For attaching the installation kit in the TS enclosure.

Material:

– Sheet steel

Surface finish:

– Zinc-plated

For enclosure depth mm	To fit Model No.	P. of	Model No.
400 500 600	9666.901/ 9666.911/ 9666.921/ 9666.931		



Equipment support connector

- For connecting 2 mounting angles for TS/SE
- Increases the stability of the frame structure

Material:

– T-section: Aluminium

P. of	Model No.
4 pc(s).	9666.740

