

# IT INFRASTRUCTURE

## IT enclosure systems

TS IT with glazed door, with 482.6 mm (19') mounting angles.....	104
TS IT with glazed door, with 482.6 mm (19') mounting frame.....	107
TS IT with vented door, with 482.6 mm (19') mounting angles.....	110
TS IT with vented door, with 482.6 mm (19') mounting frames.....	113
TS IT with glazed door, pre-configured with 482.6 mm (19') mounting frame.....	116
TS IT with vented door, pre-configured with 482.6 mm (19') mounting frame.....	118
TS IT with glazed door, pre-configured with 482.6 mm (19') swing frame.....	119
TS IT with glazed door, IP 55, with 482.6 mm (19') mounting frame.....	120
TS IT with glazed door, IP 55, empty enclosure.....	122
Cable management enclosures.....	125
Network enclosures TE 8000.....	128
Network enclosures TE 8000, pre-configured.....	130
Network enclosures TE 8000, vented.....	131
Distributor rack TE 8000 open.....	132
Data Rack distributor rack.....	133

## IT enclosures

VerticalBox.....	134
FlatBox.....	135
Wall-mounted enclosure EL, 3-part.....	137
Wall-mounted enclosure AE with 482.6 mm (19') mounting angles.....	141
Small fibre-optic distributor with m. plate & splicing cassette holder.....	142

## IT power

Power Distribution Rack/Module.....	485
Modular PDU (PSM).....	488
MID measurement module – Inline meter.....	496
Power Distribution Unit.....	502
Power supply.....	508

## IT cooling

Liquid Cooling Unit.....	518
Liquid Cooling Package.....	522
Aisle partitioning.....	529
Roof-mounted cooling unit for cooling IT equipment.....	530
Small cooling units.....	531
Computer Room Air Conditioner.....	537
Chillers for IT cooling.....	538

## IT monitoring

CMC III – Monitoring system.....	544
CMC III door control system.....	554
Dynamic Rack Control.....	561
Management software.....	562
Monitor/keyboard unit.....	563

## IT security solutions

Micro Data Center.....	568
Fire alarm and extinguisher system DET-AC/EFD III.....	573
Security rooms.....	578

## Modular data centre solutions

Edge data centre configurator.....	583
RiMatrix S cooling station.....	587
RiMatrix S rooms/containers.....	584
Data Centre Container.....	591
Balanced Cloud Center/Lefdal Mine Datacenter.....	593



## Rittal – The System.

Faster – better – everywhere.



IT segment	IT enclosure systems/cases	IT power	
	<p>The TS IT sets global standards in network and server enclosures. There's a reason for this: its ingenious design principle means that virtually every conceivable requirement of modern server and network architecture is met to perfection.</p>	<p>Put your faith in innovative IT power concepts for energy distribution and backup to meet all your redundancy, scalability and availability requirements.</p>	
<p>Product variants</p>	<p>161 enclosures, 6 distributor frames and 38 cases provide an unrivalled range in this sector, with a suitable solution for every requirement.</p>	<p>From a simple socket strip, to interlinked power distribution units (PDU) through to a complete UPS system, choose from over 100 products for a reliable power supply to your IT.</p>	
<p>Product characteristics</p>	<p>All enclosures are available off the shelf or with a short delivery time. All this plus a high load-bearing capacity of up to 15,000 N and a protection category of up to IP 55, allowing it to be used in tough industrial environments as well.</p>	<p>Optimum integration of the rack PDUs by mounting in the zero U space and professional monitoring by linking to standard DCIM software (such as RiZone). The voltage, current, active and apparent power and power factor may be transmitted directly.</p>	
<p>From page</p>	<p>481</p>	<p>483</p>	



	IT cooling	IT monitoring	IT security solutions	Modular data centre solutions
	Climate control concepts from Rittal cover the full spectrum of applications, from cooling a single rack through to entire data centres. Security plus optimum energy and cost efficiency are paramount.	Today's IT landscape would be unthinkable without monitoring. It has become firmly established as a permanent feature of physical IT security, allowing modern IT infrastructures to be operated securely.	As well as security rooms, micro data centres provide optimum protection against potential physical threats. Modularity and extendibility offer a high level of diversity and protection of your investment.	Discover brand new opportunities in the IT world with standardised data centre modules. Just one Model Number, fully functional and available for immediate delivery.
	Demand-based cooling provides the basis for optimum energy efficiency in data centres, thanks to 45 units with cooling outputs ranging from 3 to 481 kW.	More than 80 different components ensure 360° monitoring of your complete IT infrastructure.	A flexible modular system allows you to configure a solution tailored to your requirements, for both security rooms and micro data centres.	A unique selling point: Rittal offers 10 complete data centres as standard products, including a range of option packages. There are also numerous variants that may be individually compiled using a configurator.
	Integral climate control concepts for rack, suite and room climate control help to minimise operating costs and ensure energy-efficient operation over a period of many years.	The CMC III monitoring system sets new standards in terms of configuration and reducing system complexity. It can communicate with a range of sensors and actuators via the integral CAN bus, and can be integrated into standard DCIM systems.	Protection from fire, flue gases, water and dust, as well as unauthorised access. Power supply, cooling, monitoring, fire alarm and extinguisher systems round out this security cover into a complete data centre.	The maximum possible protection from physical threats and optimum scaling options, even retrospectively, ensure a sound basis for your IT investment.
	513	543	565	581

# Rittal – The System.

Faster – better – everywhere.

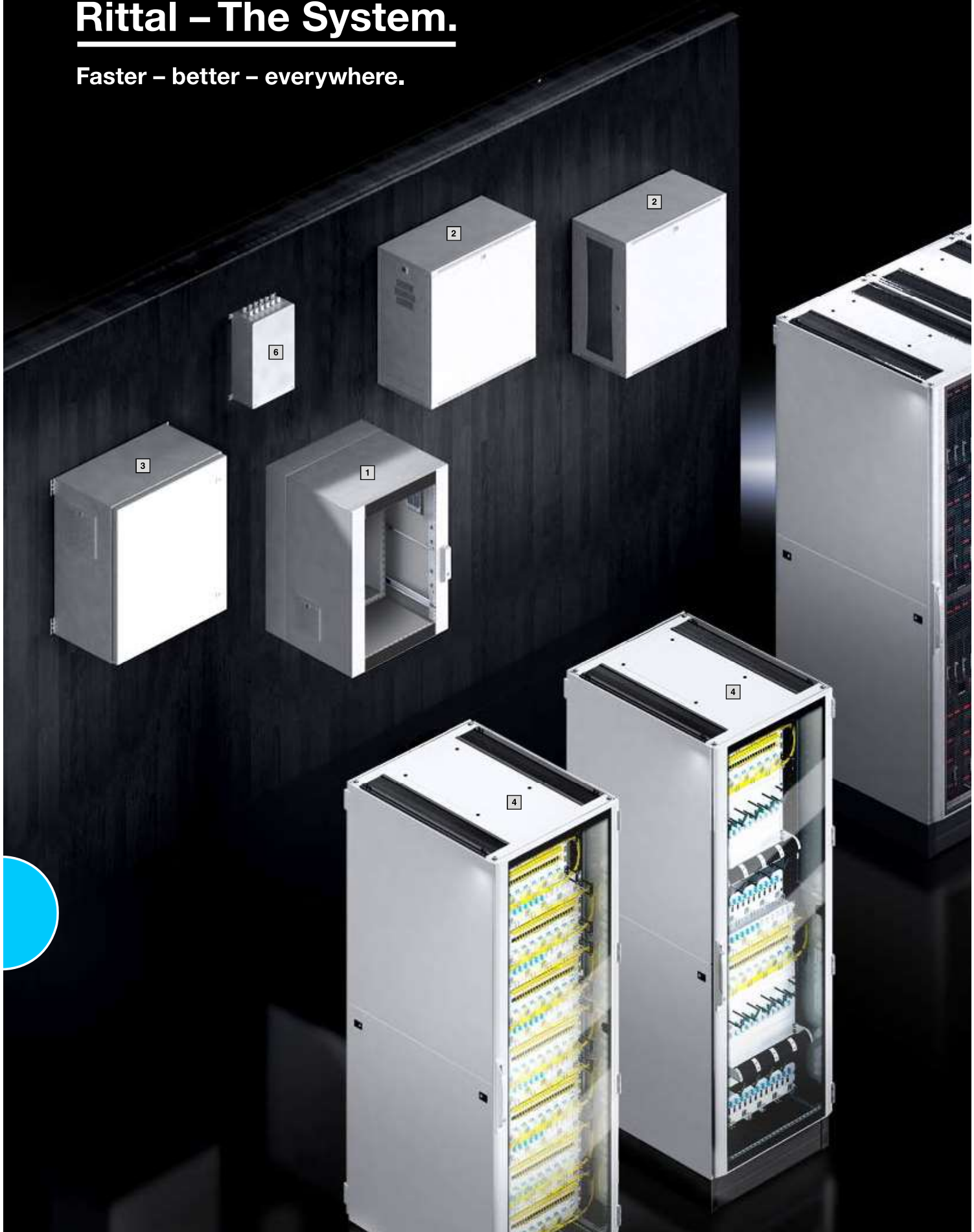

# IT enclosure systems/cases

## Network/server enclosures TS IT

with glazed door, with 482.6 mm (19") mounting angles .....	104
with glazed door, with 482.6 mm (19") mounting frame .....	107
with vented door, with 482.6 mm (19") mounting angles .....	110
with vented door, with 482.6 mm (19") mounting frame .....	113
with glazed door, pre-configured, with 482.6 mm (19") mounting frame .....	116
with vented door, pre-configured, with 482.6 mm (19") mounting frame .....	118
with glazed door, pre-configured, with 482.6 mm (19") swing frame .....	119
with glazed door, IP 55, with 482.6 mm (19") mounting frame .....	120
with glazed door, IP 55, empty enclosure .....	122

## Cable management enclosures

for TS IT .....	125
-----------------	-----

## Network enclosures TE 8000

Width 600 mm .....	128
Width 800 mm .....	129
Pre-configured .....	130
Vented .....	131

## Distributor racks

TE 8000 open .....	132
Data Rack .....	133

## IT enclosures

VerticalBox .....	134
FlatBox with 482.6 mm (19") mounting angles .....	135
FlatBox with 482.6 mm (19") mounting frame .....	136
Wall-mounted enclosure EL, 3-part, pre-configured, with mounting angles .....	137
Wall-mounted enclosure EL, 3-part, with punched rails and mounting angles .....	138
Wall-mounted enclosure EL, 3-part, with mounting plate & mounting angles .....	139
Wall-mounted enclosures AE with 482.6 mm (19") mounting angles .....	141
Small fibre-optic distributor with mounting plate & splicing cassette holder .....	142

## Your benefits

### Network/server enclosures

- Can be used individually for stand-alone installations and data centres
- Complete system solutions for small to large networks
- Maximum configuration diversity and protection for installed equipment.
- Investment protection and flexibility, thanks to simple conversions and use of our extensive modular system

### Wall-mounted enclosures

- Choose from an extensive range of products – the right enclosure to suit all applications – up to protection category IP 66
- Wide choice of sizes available from 3 U to 21 U
- Wide choice of accessories with “Rittal – The System.”
- Fast assembly, modification and simple installation based on the modular principle

## Sample applications

- 1 Wall-mounted enclosures EL, see page 137
- 2 VerticalBox, see page 134
- 3 Wall-mounted enclosures AE with 482.6 mm (19") mounting angles, see page 141
- 4 TS IT with glazed door for rack climate control, see page 100, base/plinth and installation accessories, see page 613
- 5 TS IT with vented door for room climate control, see page 100, bayed with base/plinth and installation accessories, see page 613
- 6 Small fibre-optic distributor, see page 142



# Rittal – The System.

Faster – better – everywhere.



# IT power

## Power Distribution Rack

Power Distribution Rack PDR .....	485
Power Distribution Module PDM .....	485

## Modular PDU (PSM)

PSM busbars.....	488
PSM measurement bar for CMC III .....	490
PSM socket modules.....	491
PSM measurement modules.....	492
PSM accessories.....	494

## MID measurement module

Inline meter for CMC III .....	496
Inline meter accessories.....	498

## Power Distribution Unit

PDU international.....	502
PDU UK.....	504
PDU accessories .....	504
PDU configuration .....	505
PDU sample applications.....	506
PDU technical specifications .....	506

## Voltage supply

Socket strips .....	508
---------------------	-----

## Your benefits

- Holistic, systematic energy management concepts
- Comprehensive, complete solutions for power distribution and back-up, consistently modular, and flexibly extendible at any time
- Optimum energy and cost efficiency with maximum availability of the entire system
- Reduced installation, administration and manpower costs
- High level of investment security
- All from a single source

## Sample applications

- 1 Power Distribution Rack PDR, see page 485
- 2 Power Distribution Module PDM, see page 485
- 3 Power Distribution Unit PDU, see page 502
- 4 Power distribution, see page 247
- 5 UPS (partner product)



# Rittal – The System.

Faster – better – everywhere.

## Rittal ABB UPS systems – The reliable power supply



ENCLOSURES

POWER DISTRIBUTION

CLIMATE CONTROL

IT INFRASTRUCTURE

SOFTWARE & SERVICES



FRIEDHELM LOH GROUP



# Power Distribution Rack



## Power Distribution Rack PDR

- To accommodate a maximum of 8 PDM
- Height 1.20 m for 4 PDMs and height 2 m for 8 PDMs
- PDM may be retrofitted whilst operational
- A maximum of 32 racks may be fitted to the sub-distributor
- Fully shock hazard-protected
- Master switch in various configurations:
  - Isolator switch
  - Fuse-switch disconnecter
  - Circuit-breaker
  - RC circuit-breaker
- Low-voltage distribution up to 250 A

## Material:

- Sheet steel

## Surface finish:

- Enclosure frame: Dipcoat-primed
- Doors, roof and base/plinth: Dipcoat-primed, powder-coated
- Gland plates, punched sections with mounting flanges and mounting angles: Zinc-plated, clear chromated

## Colour:

- RAL 7035

## Supply includes:

- Enclosure frame with solid sheet steel door (without tubular door frame)
- Rear panel
- Side panels and roof plate
- Levelling feet incl. base/plinth adaptor
- Earthing of all enclosure panels
- Busbars shock-hazard-protected
- Integral master switch

## Note:

- Observe the standards of the local electricity supply companies

## Approvals:

- VDE

## Power Distribution Module PDM

- Mechanically latching in the PDR
- Scalable
- RC circuit-breaker optional
- Customer-specific configuration of the PDM module and other connection cable lengths available on request

## Supply includes:

- 482.6 mm (19") module, 3 U
- Master switch
- 4 fused 3-phase outlets to the rack
- 3 x 230 V/16 A per outlet
- Connected load 400 V, 3 AC, max. 63 A

Photo shows a configuration example with equipment not included in the scope of supply

## Power Distribution Rack PDR

	Packs of	4	8
Possible number of PDM modules		4	8
<b>Width</b> mm		800	800
<b>Height</b> mm		1200	2000
<b>Depth</b> mm		500	500
<b>Model No.</b>	1 pc(s).	<b>7857.310</b>	<b>7857.300</b>
<b>Accessories</b>			
Flex-Block base/plinth system		see page 616	
TS base/plinth		see page 618	

## Power Distribution Module PDM

	Packs of	3	
U		3	
Design		4 outlets per 10 kW	
<b>Width</b> mm		482.6 (19")	
<b>Height</b> mm		133.4	
<b>Depth</b> mm		350	
<b>Model No.</b>	1 pc(s).	<b>7857.320</b>	
<b>Also required</b>			
Plug & play connection cable for PSM busbar to the server enclosures.	Length 3 m	1 pc(s).	<b>7857.130</b>
	Length 5 m	1 pc(s).	<b>7857.150</b>
	Length 9 m	1 pc(s).	<b>7857.190</b>

# Extremely flexible – The modular PDU



Modern IT equipment is constantly evolving, requiring permanent adjustments to the IT infrastructure. With a modern PDU, you can react flexibly at any time to changing requirements for the IT power supply in the server rack, even years later. You can change the slot configuration of the modular PDU (PSM) at any time, and even add completely new functions, without having to interrupt the power supply to the IT rack.

### Flexible configuration

- Vertical, contactless busbar as the basic equipment for any IT rack
- Versatile, plug-in modules with a range of socket types for any application, may be exchanged while operational
- Supports a redundant power supply in a busbar
- Patented plug & play system for changing the modules while operational

### Convincing functions

- Extensive power measurement and switching functions for each output slot, both individually and in groups
- Easily integrated into the CMC III monitoring system
- Single-phase or 3-phase infeed, up to 22 kW per busbar
- Support of all standard protocols in conjunction with CMC III

### Top quality

- High-quality aluminium enclosure
- Ambient temperature up to 60°C
- High level of measurement accuracy
- Patented system for a reliable investment



# Modular PDU (PSM)

## PSM busbars

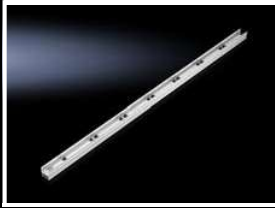

### PSM busbars and PSM socket modules

#### PSM busbars

The modular system facilitates basic configuration of the racks, thanks to a vertical support rail with single-/3-phase infeed. The various socket modules to supply the active components may be snap-fitted into the support rail. This can even be done whilst the system is operational, because the support section is shock hazard-protected.

#### PSM socket modules

The various modules, earthing pins, IEC 60 320 etc. may be inserted into the support rail in any combination. This is easily achieved, even by non-electricians, thanks to the shock hazard protected plug & play system.

#### Approvals:

Available on the Internet

#### Technical specifications/benefits:

- Each socket module picks off a phase on the support rail, either from infeed **A** or from the redundant infeed **B**, depending on the direction of connection
- Single-/3-phase construction with a maximum current of 2 x (3 x 16 A)
- 3-phase redundant infeed supported
- The redundant circuit is completely separate from the 3 phases of the support rail
- Modules may be retrofitted whilst operational
- Modules may be equipped with integral overcurrent protection, so that only the affected module is deactivated in the event of an excessively high current; the other modules remain operational
- Overvoltage protection may be integrated into the supply line
- Various modules also available with current measurement and switchable outputs



# Modular PDU (PSM)

## PSM busbars

### PSM busbars

Type	Model No.				
	7856.005	7856.006	7856.008	7856.010	7856.020
Packs of	1 pc(s).	1 pc(s).	1 pc(s).	1 pc(s).	1 pc(s).
Minimum height of rack (mm)	2000	2000	2200	1200	2000
Type of connection/length	fixed/3 m	fixed/3 m	WAGO jack	WAGO jack	WAGO jack
Connector	CEE	CEE	X-COM	X-COM	X-COM
No. of infeeds	1	2	2	2	2
No. of phases	3	3	3	3	3
Phase current (A)	16	16	16	16	16
Various connection cables, also for single-phase connection	-	-	■	■	■
No. of PSM module slots	7	7	8	4	7
Integral energy measurement of voltage, current, active power, apparent power, active energy, power factor, mains frequency	-	-	-	-	-
Measurement accuracy (U, I, f, P, S)	-	-	-	-	-
Measurement accuracy (E/kWh)	-	-	-	-	-
Graphic display to show the measurements (24 V DC required)	-	-	-	-	-
CAN bus interface for connecting to CMC III system	-	-	-	-	-
Web server (IPv4, IPv6, SNMP, SSH) via CMC III (PU 7030.000/PU Compact 7030.010)	-	-	-	-	-
E-mail forwarding for exceeded limits and alarms (CMC III required)	-	-	-	-	-
Operating temperature (°C)	5 – 45				
Ambient humidity % (non-condensing)	10 – 90				
Protection category IP (to IEC 60 529)	IP 20				
Approvals	CE	CE	CE	CE/VDE	CE/VDE

Type	Model No.			
	7856.321	7856.323	7859.050	7859.053
Packs of	1 pc(s).	1 pc(s).	1 pc(s).	1 pc(s).
Minimum height of rack (mm)	2000	2000	2000	2000
Type of connection/length	fixed/3 m	fixed/3 m	WAGO jack	fixed/3 m
Connector	CEE	CEE	X-COM	CEE
No. of infeeds	1	1	2	1
No. of phases	1	3	3	1
Phase current (A)	32	32	16	32
Various connection cables, also for single-phase connection	-	-	■	-
No. of PSM module slots	6	6	6	6
Integral energy measurement of voltage, current, active power, apparent power, active energy, power factor, mains frequency	-	-	■	■
Measurement accuracy (U, I, f, P, S)	-	-	2%	2%
Measurement accuracy (E/kWh)	-	-	1%	1%
Graphic display to show the measurements (24 V DC required)	-	-	■	■
CAN bus interface for connecting to CMC III system	-	-	■	■
Web server (IPv4, IPv6, SNMP, SSH) via CMC III (PU 7030.000/PU Compact 7030.010)	-	-	■	■
E-mail forwarding for exceeded limits and alarms (CMC III required)	-	-	■	■
Operating temperature (°C)	5 – 45			
Ambient humidity % (non-condensing)	10 – 90			
Protection category IP (to IEC 60 529)	IP 20			
Approvals	CE	CE	CE	CE

#### ! Also required:

- PSM socket modules, see page 491

#### + Accessories:

- Mounting kit for PSM busbars, see page 494
- Connection cables, see page 494
- Cable lock, see page 495
- Overvoltage protection, see page 494



# Modular PDU (PSM)

## PSM measurement bar



### PSM measurement bar for CMC III

Measurement bars for direct connection to the CMC III system. With a PSM mounting kit, the measurement bar may be vertically mounted in a 2000 mm high TS 8 or in the TS IT rack. Display and monitoring of all major output parameters is supported, separated by phase and infeed. An integral display provides a local on-site display in the rack. Remote administration and network connectivity are created via the CMC III system.

#### Benefits:

- Modular extendible system
- For 16 A and 32 A phase current
- Various PSM connection modules (pin patterns)
- PSM modules may be connected with the system operational
- VDE-tested, shock hazard-protected system
- Easy to assemble
- CAN bus for connection to CMC III system
- Extensive management and monitoring functions (via CMC III)
- High-MTBF and measurement accuracy of 1%
- Energy-efficient electric design – minimal inherent power consumption
- High-quality aluminium housing, for flexible mounting

#### Measurement functions:

- Voltage (V), current (A), frequency (Hz)
- Active power (kW), active energy (kWh), apparent power (VA), apparent energy (kVAh)
- Power factor (cos phi)
- Zero conductor current measurement/load imbalance detection
- Measurement per phase or infeed
- Measurement accuracy 1% (kWh) to IEC 50 430-1

#### Material:

- Extruded aluminium section, anodised

#### Protection category IP to IEC 60 529:

- IP 20

#### Standards:

- EN 60 950
- EN 61 000-6-1
- EN 61 000-6-2
- EN 55 022

#### Low Voltage Directive:

- 2014/35/EU

#### EMC directive:

- 2014/30/EU

#### Approvals:

Available on the Internet

Photo shows a configuration example with equipment not included in the scope of supply

Model No.	7859.050	7859.053	Page
Packs of	1 pc(s).	1 pc(s).	
Version/rated current A (per phase)	16	32	
No. of infeeds (3-phase, 16 A/single-phase, 32 A)	2	1	
Connection cable, plug-in, various configurations	■	–	
Connection cable, fixed, 3 m, with CEE connector, 32 A, single-phase (IEC 60 309)	–	■	
Electromagnetic circuit-breaker (2 x 16 A, type C)	–	■	
Input voltage 230 V/400 V (50/60 Hz)	■	■	
Power supply via CMC III system (24 V DC)	■	■	
CAN bus for direct connection to CMC III system (RJ 45, 2 x sockets)	■	■	
Maximum no. of systems that may be connected to one CMC III PU	8	8	
<b>Ambient conditions</b>			
Operating temperature	0°C...+45°C		
Storage temperature	-25°C...+70°C		
Ambient humidity % (non-condensing)	10 – 95		
<b>Accessories</b>			
PSM connection cable, 3-phase, with CEE connectors (IEC 60 309), length 3 m (2 x required when using both infeeds)	7856.025	Fixed installation	494
PSM mounting kit for mounting on the TS IT enclosure frame, height 2000 mm	7856.029	7856.029	494
PSM module 4 x earthing-pin, black	7856.100	7856.100	491
PSM module 4 x earthing-pin, red	7856.240	7856.240	491
PSM module 6 x C13	7856.080	7856.080	491
PSM module 4 x C19	7856.230	7856.230	491
Other PSM socket modules	see page 491		

# Modular PDU (PSM)

## PSM socket modules

### PSM socket modules

max. 16 A/3680 W per module

Equipment	Model No.							
	1							
	7856.080	7856.082	7856.100	7856.240	7856.230	7856.070	7856.220	7856.090
Packs of	1 pc(s).	1 pc(s).	1 pc(s).	1 pc(s).	1 pc(s).	1 pc(s).	1 pc(s).	1 pc(s).
Occupied slots in PSM busbar	1	1	1	1	1	1	1	1
Connector pattern (type)	IEC 60320 C13	IEC 60320 C13	Earthing-pin CEE7/3	Earthing-pin CEE7/3	IEC 60320 C19	IEC 60320 C13	IEC 60320 C13	Earthing-pin CEE7/3
Number of outputs	6	6	4	4	4	6	4	4
Colour of slots	black	red	black	red	black	black	black	black
Lockable connectors (optional)	■	■	-	-	-	-	-	-
Miniature fuse per output	-	-	-	-	-	-	■	-
Thermal overload protection	-	-	-	-	-	■	-	■
Optical LED display (total current)	-	-	-	-	-	-	-	-
Optical LED display (switching status/status)	-	-	-	-	-	-	-	-
Illuminated colour display (display of measurements/alarms)	-	-	-	-	-	-	-	-
Switchable outputs (via CMC III)	-	-	-	-	-	-	-	-
Energy measurement per module (total values)	-	-	-	-	-	-	-	-
Dimensions (W x H x D) mm	52 x 250 x 45							
Operating temperature	5°C – 45°C							
Ambient humidity (non-condensing)	10% – 95%							
Material	Extruded aluminium section/plastic							
Approvals	CE	CE	CE/VDE	CE	CE	CE	CE	CE

Equipment	Model No.						
	2		3		4		
	7856.120	7856.191	7859.120	7859.130	7859.410	7859.420	7859.430
Packs of	1 pc(s).	1 pc(s).	1 pc(s).	1 pc(s).	1 pc(s).	1 pc(s).	1 pc(s).
Occupied slots in PSM busbar	1	1	1	1	2	2	2
Connector pattern (type)	UTE CEE7/5	Switzerland T23	IEC 60320 C13	IEC 60320 C19	IEC 60320 C13	IEC 60320 C19 (+ 2 C13)	Earthing-pin CEE7/3 (+ 2 C13)
Number of outputs	4	4	6	4	8	6	6
Colour of slots	black	black	black	black	black	black	black
Lockable connectors (optional)	-	-	■	-	■	■	-
Miniature fuse per output	-	-	-	-	-	-	-
Thermal overload protection	-	-	-	-	-	-	-
Optical LED display (total current)	-	-	■	■	-	-	-
Optical LED display (switching status/status)	-	-	-	-	■	■	■
Illuminated colour display (display of measurements/alarms)	-	-	-	-	■	■	■
Switchable outputs (via CMC III)	-	-	-	-	■	■	■
Energy measurement per module (total values)	-	-	-	-	■	■	■
Dimensions (W x H x D) mm	52 x 250 x 45				52 x 505 x 45		
Operating temperature	5°C – 45°C				5°C – 60°C (at max 8 A per switch output)		
Ambient humidity (non-condensing)	10% – 95%						
Material	Extruded aluminium section/plastic						
Approvals	CE	CE	CE	CE	CE	CE	CE

#### Approvals:

Available on the Internet



# Modular PDU (PSM)

## PSM measurement modules



### PSM measurement modules with CAN bus

#### for PSM busbars

A power meter and switching functions for the output slots can be added to any PSM busbar with these PSM plug-in modules. The modules are also suitable for upgrading existing PSM installations if it becomes necessary to record the power data or add a switching option for the connected equipment.

There are three variants available with different socket types. In the PSM busbar, the PSM modules occupy two module slots each. Measurements are displayed locally on a backlit LC display. For quick checks, the colour of the display backlight changes to red if current and power limits are exceeded.

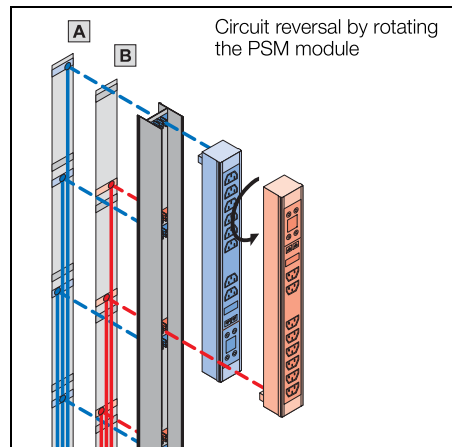

### Integration into the CMC III monitoring system

Multiple modules may be interconnected and linked directly to the CMC III enclosure monitoring system via the integral CAN bus interface. The PSM measurement module supports the configuration of an energy data management (EMS) system to ISO 50001. This may be combined with the CMC III. Using the CMC III, the individual output slots of the PSM modules may be switched individually or in groups via the network. Similarly, data logging, including diagrammatic representation, is also available via the CMC III website. Data is forwarded from the CMC III via an Ethernet interface with common protocols such as SNMPv3, Modbus/TCP and OPC-UA. The switch function is easily linked to other sensors connected to the CMC III monitoring system (e.g. CMC III temperature sensor, smoke alarm or DET-AC III extinguisher system). In larger installations, we recommend incorporating the CMC III PU with PSM modules into a DCIM software package (e.g. RiZone).

#### Additional functions:

- Alarm management via CMC III (e.g. e-mail or text message)
- Visualisation of the switching status on the CMC III website and RiZone
- Up to 16 PSM modules on one CMC III PU (per IP address)
- Rights management via CMC III (e.g. restriction of the switching function)

#### Functions:

- Simple, shock-hazard-protected, plug & play installation with the system operational
- Measurement of power consumption per module
- Output slots may be switched individually and in groups
- Blue LEDs per slot to visually indicate the switching status
- Status LEDs for CAN bus communication per module
- LC matrix display with multi-coloured backlight for local display
- Location sensor for correct display and Web view in 90° increments
- Adjustable limits for voltage, current and active power
- Configurable overload detection per module
- High level of measurement accuracy
- Alarm signalling via the display
- Facilitates the implementation of requirements to ISO 50001 and EN 50600-2-2
- Stable aluminium section with plastic socket inserts
- Supports universal connector locking of the IEC 60320, C13 and C19 slots
- Supports the closure of unneeded IEC 60320, C13 and C19 slots
- PSM module is easily fitted into and removed from the PSM busbar, allowing it to be used at changing locations
- Compatible with the European PSM busbar range
- Depending on the PSM busbar, up to four modules per bar may be fitted
- In redundant systems, the circuit may be switched over by rotating the module
- For ambient temperatures up to +60°C

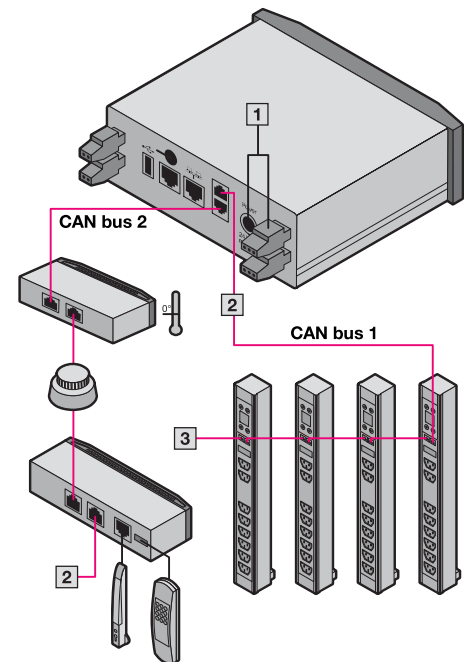

- 1 Voltage supply 24 V (DC) and redundant voltage supply 24 V (DC)
- 2 Supports up to 16 sensors per CAN bus (depending on the power supply/connection combinations)
- 3 Supports up to 8 PSM modules per CAN bus



# Modular PDU (PSM)

## PSM measurement modules

### PSM measurement modules with CAN bus

#### for PSM busbars

#### Supply includes:

- PSM measurement module, depending on type
- CAN bus connection cable, 1 m long

#### ! Also required:

- PSM busbar and accessories, see page 489
- CMC III PU, see page 548
- CMC III accessories, see page 549

#### + Accessories:

- Slot cover, see page 495
- Connector lock, see page 495
- Power pack, see page 494



Model No.	7859.410	7859.420	7859.430
Packs of	1 pc(s).	1 pc(s).	1 pc(s).
No. of IEC 60 320 C13 slots	8	2	2
No. of IEC 60 320 C19 slots	-	4	-
No. of earthing-pin slots (CEE 7/3 or type F)	-	-	4
Total no. of all switchable outputs	8	6	6
No. of slots required in the PSM busbar	2	2	2
Module dimensions (W x L x D) mm	53 x 500 x 45		
Section	Aluminium, anodised		
Plastic	PA 6		
<b>Electrical</b>			
No. of infeeds per module	1 pc(s).		
Input voltage	230 V AC		
Input voltage, tolerance	207 – 250 V AC		
Rated current	16 A		
Distribution power per module (at 230 V)	3680 W		
Power supply (via CMC III system, alternatively with power pack 7201.210)	18 – 24 V DC		
Relay type	Dual coil/bistable		
Relay switching load	4000 VA		
<b>Measurement functions</b>			
Voltage V, current A, frequency Hz	■		
Active power kW, active energy kWh	■		
Reactive power kVar, reactive energy kVarh	■		
Apparent power kVA, apparent energy kVAh	■		
Power factor cos φ, crest factor (amplitude factor)	■		
Operating hours meter d, h, min	■		
Measurement accuracy	±1%		
<b>Resettable measurement functions/reset via software/interval measurement</b>			
Active energy kWh	■		
Operating hours meter h	■		
Threshold values (warning/alarm) freely configurable	Voltage, current, active power		
<b>Connectivity/management functions (in conjunction with CMC III)</b>			
Maximum number of usable modules per CMC III Processing Unit	16 (2 x 8)		
Maximum number of usable modules per CMC III Processing Unit Compact	4		
CAN bus for direct linking to CMC III system	2 (RJ 45)		
Network functionality (only in conjunction with CMC III system)	IPv4, IPv6, SNMPv3, Modbus/TCP, OPC-UA		
<b>Ambient conditions</b>			
Operating temperature (at max. 8 A per output slot)	+5...+60°C		
Storage temperature	-20...+70°C		
Ambient humidity (non-condensing)	rel. humidity 10 – 90%		
Maximum operating altitude	2000 m		
Pollution degree	2		
Protection class (IEC 60 529)	IP 20		
<b>Approvals and standards</b>			
Approval	CE		
Standard (excerpt)	Low Voltage Directive 2014/35/EU, EMC Directive, 2014/30/EU, EN 50600-2-2, EN 60950		

# Modular PDU (PSM)



## Mounting kit for PSM busbars

### Without cable routing

For	Installation options	Packs of	Model No.
TE 8000	Static	2 pc(s).	<b>7000.684</b>
TS	Static	1 pc(s).	<b>7856.011</b>
TS IT	Plug & play	2 pc(s).	<b>7856.029</b>

### With cable routing

For	Installation options	Packs of	Model No.
TS	Static	1 pc(s).	<b>7856.022</b>
	Adjustable, for freely accessible 482.6 mm (19") level	1 pc(s).	<b>7856.023</b>

## Connection cable for PSM busbar

Connection cable (3-phase)			
	Length m	Packs of	Model No.
CEE-conforming 5-pole/16 A	3	1 pc(s).	<b>7856.025</b>
Connection cable, single-phase			
CEE-conforming 3-pole/16 A	3	1 pc(s).	<b>7856.026</b>
Connection cable, UPS, single-phase			
C14/X-COM 10 A/UPS, 1 – 2 kVA	3	1 pc(s).	<b>7856.027</b>
C20/X-COM 16 A/UPS, 3 kVA	3	1 pc(s).	<b>7856.030</b>
Connection cable C19/C20			
16 A	2	1 pc(s).	<b>7200.217</b>
Connection cable C13/C14			
10 A	0.5	2 pc(s).	<b>7856.014</b>

## Overvoltage protection PSM

Connected upstream of the busbar.

- 230/400 V, 16 A, 3-phase
- Fine fuse (type 3 arrester)
- Connection:
  - Jack Wago X-COM
  - Connector Wago X-COM

Overvoltage protection	Packs of	Model No.
With adaptor connector	1 pc(s).	<b>7856.170</b>

### Note:

- With redundant infeed to the PSM busbar, 2 x this item is required!

## Power pack for PSM

For operating the PSM measurement modules (with switch and measurement function) or PSM measurement bars if no CMC III is used. The power pack has a connection cable with RJ45 connector, suitable for use with the PSM measurement modules and measurement bars.

Packs of	Model No.
1 pc(s).	<b>7201.210</b>

### Technical specifications:

- Dimensions W x H x D: 60 x 30 x 135 mm
- Rated operating voltage: 100 V – 240 V, 1~, 50/60 Hz
- Ambient conditions:
  - Operating temperature: +5°C...+45°C
  - Operating humidity, non-condensing 10% – 90%
- Output voltage: 24 V DC
- Connections: Input: IEC/EN 60 320 C14  
Output: RJ 45  
Output cable: 1 m long

# Modular PDU (PSM)

## Cable lock PSM

**for all modules with EN 60 320 C13 connector configurations**

All terminal connection cables are therefore protected against unintentional disconnection of the power supply. Two bars are needed for two cables.

Type	Packs of	Model No.
Bar	20 pc(s).	7856.013

### + Accessories:

- Optimum locking function is only achieved with connection cable 7856.014, see page 494.



## Connector lock

**for C14 and C20 connectors**

The universal lock can be used to latch IEC 60 320 C14 or C20 connectors in place to prevent accidental removal. Latching is adjustable and adapts to standard connector forms. This creates a reliable manufacturer-independent connection for most connection cables commonly available on the market.

### Material:

- Plastic (PA 12)

### Colour:

- RAL 9005

Packs of	Model No.
20 pc(s).	7955.020



## Slot cover

**for C13 and C19 slots**

The slot cover is used to close open, unused IEC 60 320 C13 and C19 slots. This prevents accidental overloading of individual phases. The cover can be removed at any time using the enclosed release tool (or a slotted screwdriver).

### Material:

- Plastic (PA 66)

### Colour:

- RAL 9005

For slots	Packs of	Model No.
C13	10 pc(s).	7955.010
C19	10 pc(s).	7955.015



## PDU mounting adaptor

**for TE**

For installing the power distribution unit PDU in the zero U space of the TE. The divider kit included with the supply of the PDU is required for mounting.

### Material:

- Sheet steel, zinc-plated

### Supply includes:

- Assembly parts

Packs of	Model No.
2 pc(s).	7000.688



# MID measurement module – Inline meter



CMC III monitoring system Page 544

The PSM 1 U MID measurement modules may be used for upgrading existing installations or for measuring individual 16 A/32 A equipment. These are readily integrated into the 482.6 mm (19") level or into the zero-U space of the rack, and connected using suitable connection cables. These measurement modules have an MID-compliant active energy meter and are therefore suitable for energy billing purposes. MID stands for "Measurement Instruments Directive" and regulates 10 types of measurement equipment based on EU Directive 2004/22/EC. MID-approved equipment is authorised for use throughout the EU.

**Benefits:**

- For 16 A and 32 A phase current
- Easy to assemble
- Billable MID measurement units
- CAN bus for connection to CMC III system
- Extensive management and monitoring functions (via CMC III)
- High-MTBF and measurement accuracy of  $\pm 1\%$
- Energy-efficient electric design – minimal inherent power consumption
- 1 U, 482.6 mm (19") sheet steel enclosure, for flexible mounting

**Measurement functions:**

- Voltage (V), current (A), frequency (Hz)
- Active power (kW), active energy (kWh), apparent power (kVA), apparent energy (kVAh)
- Power factor (cos phi)
- Zero conductor current measurement/load imbalance detection
- Measurement per phase or infeed
- Measurement accuracy  $\pm 1\%$  (kWh) to IEC 50 430-1
- MID certification of the active energy meter, suitable for energy billing purposes

**Material:**

- Housing: Sheet steel

**Colour:**

- RAL 9005

**Protection category IP to IEC 60 529:**

- IP 51

**Standards:**

- EN 60 950
- EN 61 000-6-1
- EN 61 000-6-2
- EN 55 022

**Low Voltage Directive:**

- 2014/35/EU

**EMC directive:**

- 2014/30/EU

Photo shows a configuration example with equipment not included in the scope of supply

## for CMC III

Model No.		7859.312	7859.332
	Packs of	1 pc(s).	1 pc(s).
Rated current A (per phase)		16	32
Sheet steel enclosure 1 U for 482.6 mm (19") mounting, approx. 200 mm deep		■	■
Assembly parts		■	■
Input voltage 230 V/400 V (50/60 Hz)		■	■
No. of infeeds (each 3-phase)		2	2
Power supply across all 3 phases (internal power pack)		■	■
Maximum no. of systems that may be connected to one CMC III PU		8	8
<b>Ambient conditions</b>			
Operating temperature		-25°C...+55°C	-25°C...+55°C
Storage temperature		-25°C...+70°C	-25°C...+70°C
Ambient humidity % (non-condensing)		20 – 90	20 – 90
<b>Also required</b>			
Connection cables, set: 1 x input 2 m/1 x output 2 m CEE (IEC 60 309 jack) (2 x required when using both infeeds)	1 pc(s).	7859.315	7859.335
Connection cables for PSM busbars: Input cable 3 m (with CEE connector)/output cable 1.2 m (with Wago X-COM connector) (2 x required when using both infeeds)	1 pc(s).	7859.316	–

# MID measurement module – Inline meter

## for CMC III

MID approval for energy billing purposes is valid for 8 years and can be extended for a further 8 years by recalibrating the MID measurement module. This measurement device is connected into the connection cable (infeed) of the equipment or the power distributor.

For connecting to PSM busbars with Wago X-COM connectors, a special preassembled connection cable set with CEE connector and/or coupling is required. The Rittal CMC III is required for network functionality and data communication via SNMP.

Technical specifications		7859.312	7859.332
Input current		16 A	32 A
Number of phases per circuit		3	3
Number of circuits		2	2
Connection type		Industry plug connector	
Connectors, inputs / outputs		HARTING HAN Q4/2/Ilme CQ 08V EN 60 309 – CEE 3L+N+PE 6h, IP 44	
Connection cable type		H07 RN-F (optional cable kits)	
Number of wires		5	
Cable cross-section		4 mm <sup>2</sup>	
MID module, enclosure width		450 mm (19")	
MID module, enclosure depth		200 mm	
MID module, enclosure height		44.45 mm (1 U)	
PDU material		Sheet steel, spray finished in RAL 9005 (black)	
Measurement functions (input/phase or output slot)	Voltage measurement range	180 – 260 V	
	Voltage resolution	0.1 V	
	Voltage accuracy	2%	
	Current measurement range	0 – 35 A	
	Current resolution	0.1 A	
	Current accuracy	2%	
	Frequency accuracy	2%	
	Active power (kW) accuracy	2%	
	Apparent power (VA) accuracy	2%	
	Active energy (kWh) accuracy	1%	
	Apparent energy (kVAh) accuracy	2%	
	Power factor accuracy	2%	
	Freely settable limit values for warning/alarm	Yes	
Zero conductor current measurement/load imbalance detection	Yes		
Display		OLED monochrome / 2 lines	
Interface		RJ 45, CAN bus (CAN-Open)	
Protocols supported via optional CMC III		HTTP, HTTPS, SSL, SSH, NTP, Telnet, TCP/IP v4 and v6, DHCP, DNS, NTP, Syslog, SNMP v1, v2c and v3, XML, FTP/SFTP (update/file transfer), e-mail forwarding (SMTP), OPC-UA, Modbus/TCP	
Max. number of MID modules per CMC III PU Compact		4	
Max. number of MID modules per CMC III PU		8	
Installation position		Horizontally screw fastened in the 482.6 mm (19") level	
Assembly parts included with the supply		Cage nuts M5 (4 x), screws M5x14 (4 x)	
Conformity		CE	
MTBF (at 40°C)		200,000 hours	
Standards		EN 50 470-1, EN 50 470-3, MID Directive 2004/22/EG	
Safety		EN 60 950-1	
EMC		EN 61 000-6-2, EN 61 000-6-3, EN 55 022/B	
Protection category		3	
Contamination level		2	
Protection category		IP 51 (IEC 60 529)	
Storage temperature		-25°C...+70°C	
Ambient temperatures (operation)		-25°C...+55°C	
Ambient humidity		20% – 90%, non-condensing	

# MID measurement module – Inline meter



## Connection cable

### for MID measurement module/inline meter

#### What is MID?

MID stands for "Measurement Instruments Directive" and regulates 10 types of measurement equipment based on EU Directive 2004/22/EC.

The aim is to harmonise the approval of measurement equipment in the Member States. However, country-specific regulations (such as the Calibration Act in Germany) continue to apply.

MID regulates the entire manufacturing process, from development, to production, through to final testing of the measurement equipment. General and device-specific performance requirements are defined in the MID, which the manufacturer must comply with. Following successful testing, the MID-approved devices are labelled and may be sold throughout the EU.

#### Benefits:

- Easy to install active energy meter based on the plug & play system
- Variants for 16 A and 32 A phase current
- Two independent circuits in each case (3-phase)
- Pre-assembled connection cable with CEE connector/coupling
- Simple, flexible assembly
- Billable MID measurement units
- CAN bus for connection to CMC III system
- Extensive monitoring functions (via CMC III)
- High-MTBF and measurement accuracy of 1%
- Energy-efficient electric design – minimal inherent power consumption
- High quality sheet steel enclosure

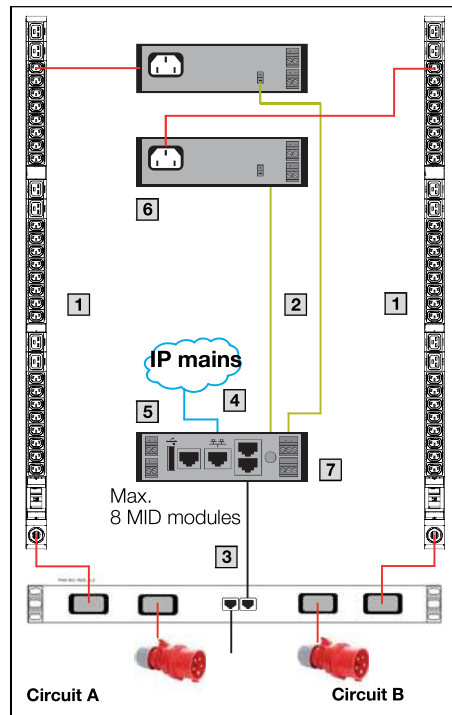

#### Type of cabling:

- 1 230 V/400 V mains
- 2 24 V DC, buffered
- 3 CMC III CAN bus
- 4 Network/IP/SNMP
- 5 Serial connection
- 6 CMC III power pack (optional redundant design with 2 power packs supported)
- 7 CMC III PU/PU compact

	A	B	A
<b>Model No.</b>	<b>7859.315</b>	<b>7859.316</b>	<b>7859.335</b>
Packs of	1 pc(s).	1 pc(s).	1 pc(s).
<b>Product-specific scope of supply</b>			
Input & output cables for one circuit of the PSM MID module <sup>1)</sup>	■	■	■
Connector (type) input	CEE	CEE	CEE
Connector (type) output	CEE	Wago X-COM	CEE
<b>Technical specifications</b>			
Connector (type)	CEE 3L+N+PE 6h	CEE 3L+N+PE 6h	CEE 3L+N+PE 6h
Socket/jack (type)	CEE 3L+N+PE 6h	Wago X-COM	CEE 3L+N+PE 6h
Rated current (max.) A	16	16	32
Connection cable type	H07RN-F	H07RN-F	H07RN-F
Length of connection cable (input) m	2	3	2
Length of connection cable (output) m	2	1.2	2
No. of wires	5	5	5
Cross-section of connection cables mm <sup>2</sup>	2.5	2.5	4
Operating temperature range	-25°C...+55°C	-25°C...+55°C	-25°C...+55°C

<sup>1)</sup> If both circuits of the MID module are used, this item must be ordered twice.

# Rittal – The System.

Faster – better – everywhere.

## CMC III – Monitoring system

Computer Multi Control (CMC) is an alarm system for network and server enclosures, standard enclosures, containers and rooms.

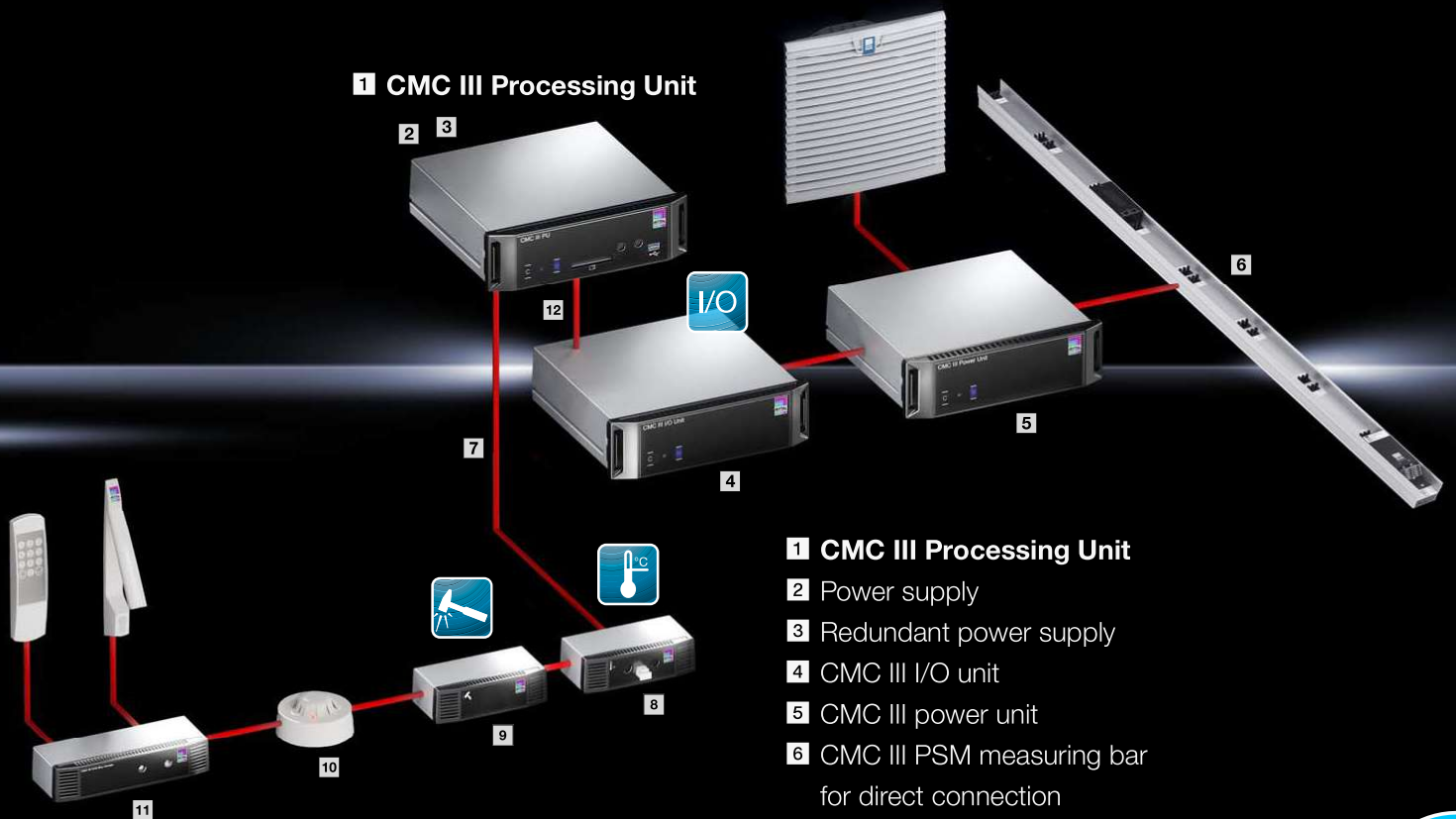

1 CMC III Processing Unit

1 CMC III Processing Unit

- 2 Power supply
- 3 Redundant power supply
- 4 CMC III I/O unit
- 5 CMC III power unit
- 6 CMC III PSM measuring bar for direct connection
- 7 Up to 16 CAN bus systems may be connected
- 8 CMC III temperature sensor
- 9 CMC III vandalism sensor
- 10 CMC III smoke alarm
- 11 CMC III CAN bus access
- 12 Up to 16 CAN bus systems may be connected

ENCLOSURES

POWER DISTRIBUTION

CLIMATE CONTROL

IT INFRASTRUCTURE

SOFTWARE & SERVICES



# Power Distribution Unit





## Simple assembly

- Compact design
- Tool-free clip attachment in the TS IT
- Flexible mounting at the required height in the zero-U space
- Also suitable for individual installation on the enclosure frame
- Reliable protection against unauthorised access by covering any outputs that are not required
- Securely fitted connectors, thanks to connector lock

## Versatile function

- Measurement of power, current, active and apparent power and power factor
- Measurement of energy consumption and neutral conductor current (with 3-phase PDUs)
- Measurement for any output is supported, depending on the PDU version
- Bistable relays ensure minimum inherent power consumption by the PDU
- Connection options for CMC III sensors (temperature, humidity, access)

## Professional monitoring

- Powerful CPU and Linux Web server
- TCP/IP v4 and v6 plus SNMP
- Configuration of limits
- User administration, e-mail sent in case of alarm
- Easily connected to DCIM software (e.g. RiZone)



# Power Distribution Unit



**Configuration** Page 505

**Benefits:**

- With the compact PDU, any IT rack is easily equipped with a professional power distribution system
- With the TS IT rack, assembly is tool-free
- Compact design
- Easy to assemble
- Power-saving design, minimal inherent consumption by the PDU itself, thanks to the use of bistable relays and OLED display with power-saving function
- Integral web server for direct network connection with extensive user administration (not PDU basic/slave PDU)

- Redundant power supply from all 3 phases and additionally via an existing PoE (Power over Ethernet) network
- Extensive range of management and monitoring functions
- High-MTBF and measurement accuracy of 1%
- CAN bus for connecting slave PDUs (not with PDU basic)
- Ambient monitoring with up to 4 CMC III sensors (temperature, humidity, access, vandalism)

**PDU design variants:**

**PDU basic**  
Robust, compact basic power distributor for the IT environment

**PDU metered**  
Energy measurement per phase, i.e. output requirement of an entire IT rack

**PDU switched**  
Measurement function per phase and individually switchable output slots

**PDU managed**  
High-end IT rack, power distribution with energy measurement and monitoring functions for each individual output slot

**Material:**

- Extruded aluminium section, anodised

**Protection category IP to IEC 60 529:**

- IP 20

**Standards:**

- EN 60 950
- EN 61 000-4
- EN 61 000-6
- EN 55 022

**Low Voltage Directive:**

- 2014/35/EU

**EMC directive:**

- 2014/30/EU

Photo shows a configuration example with equipment not included in the scope of supply

## PDU international, basic version

No. of phases	Power		Pin patterns			Dimensions PDU length mm	PDU installed in rack/min. enclosure height mm				Model No.
	Phase current A	Output kW	Input	Outputs C13	Outputs C19		TS IT enclosure frame	TS IT 482.6 mm (19") mounting frame	TS IT 482.6 mm (19") mounting angles	TE 8000 482.6 mm (19") mounting frame	
1	16	3.6	CEE	24	4	970	1200	1200	1800	2000	<b>7955.110</b>
1	32	7.2	CEE	24	4	1115	1800	1800	1800	2000	<b>7955.111</b>
3	16	11	CEE	18	3	845	1200	1200	1200	1200	<b>7955.131</b>
3	16	11	CEE	24	6	1145	1800	1800	1800	2000	<b>7955.132</b>
3	32	22	CEE	24	6	1365	1800	1800	1800	2000	<b>7955.133</b>
3	32	22	CEE	36	6	1710	2000	2000	2000	-	<b>7955.134</b>
3	16	11	CEE	42	-	1405	1800	1800	1800	2000	<b>7955.135</b>

# Power Distribution Unit

## PDU international, metered version

Power			Pin patterns			Dimensions	PDU installed in rack/min. enclosure height mm				Model No.
No. of phases	Phase current A	Output kW	Input	Outputs C13	Outputs C19	PDU length mm	TS IT enclosure frame	TS IT 482.6 mm (19") mounting frame	TS IT 482.6 mm (19") mounting angles	TE 8000 482.6 mm (19") mounting frame	
1	16	3.6	C20	12	–	710	1200	1200	1200	1200	<b>7955.201</b>
1	16	3.6	CEE	24	4	1225	1800	1800	1800	2000	<b>7955.210</b>
1	32	7.2	CEE	24	4	1370	1800	1800	1800	2000	<b>7955.211</b>
3	16	11	CEE	18	3	1100	1200	1800	1800	1200	<b>7955.231</b>
3	16	11	CEE	24	6	1395	1800	1800	1800	2000	<b>7955.232</b>
3	32	22	CEE	24	6	1620	1800	2000	2000	2000	<b>7955.233</b>
3	32	22	CEE	36	6	1965	2200	2200	2200	–	<b>7955.234</b>
3	16	11	CEE	42	–	1660	1800	2000	2000	2000	<b>7955.235</b>
3	32	22	CEE	48	–	2050	2200	2200	–	–	<b>7955.236</b>
3	63	44	CEE	12	12	482.6 mm (19") / 3 U	–	–	–	–	<b>7955.238</b>

## PDU international, switched version

Power			Pin patterns			Dimensions	PDU installed in rack/min. enclosure height mm				Model No.
No. of phases	Phase current A	Output kW	Input	Outputs C13	Outputs C19	PDU length mm	TS IT enclosure frame	TS IT 482.6 mm (19") mounting frame	TS IT 482.6 mm (19") mounting angles	TE 8000 482.6 mm (19") mounting frame	
1	16	3.6	C20	12	–	775	1200	1200	1200	1200	<b>7955.301</b>
1	16	3.6	CEE	24	4	1360	1800	1800	1800	2000	<b>7955.310</b>
1	32	7.2	CEE	24	4	1400	1800	1800	1800	2000	<b>7955.311</b>
3	16	11	CEE	18	3	1180	1800	1800	1800	2000	<b>7955.331</b>
3	16	11	CEE	24	6	1480	1800	1800	1800	2000	<b>7955.332</b>
3	32	22	CEE	24	6	1685	1800	2000	2000	2000	<b>7955.333</b>
3	32	22	CEE	36	6	2065	2200	2200	–	–	<b>7955.334</b>
3	16	11	CEE	42	–	1755	2000	2000	2200	–	<b>7955.335</b>
3	32	22	CEE	48	–	2110	2200	–	–	–	<b>7955.336</b>

## PDU international, managed version

Power			Pin patterns			Dimensions	PDU installed in rack/min. enclosure height mm				Model No.
No. of phases	Phase current A	Output kW	Input	Outputs C13	Outputs C19	PDU length mm	TS IT enclosure frame	TS IT 482.6 mm (19") mounting frame	TS IT 482.6 mm (19") mounting angles	TE 8000 482.6 mm (19") mounting frame	
1	16	3.6	C20	12	–	775	1200	1200	1200	1200	<b>7955.401</b>
1	16	3.6	CEE	24	4	1360	1800	1800	1800	2000	<b>7955.410</b>
1	32	7.2	CEE	24	4	1400	1800	1800	1800	2000	<b>7955.411</b>
3	16	11	CEE	18	3	1180	1800	1800	1800	2000	<b>7955.431</b>
3	16	11	CEE	24	6	1480	1800	1800	1800	2000	<b>7955.432</b>
3	32	22	CEE	24	6	1685	1800	2000	2000	2000	<b>7955.433</b>
3	32	22	CEE	36	6	2065	2200	2200	2200	–	<b>7955.434</b>
3	16	11	CEE	42	–	1755	2000	2200	2000	–	<b>7955.435</b>
3	32	22	CEE	48	–	2110	2200	–	–	–	<b>7955.436</b>

## Slave PDU international, managed version

Power			Pin patterns			Dimensions	PDU installed in rack/min. enclosure height mm				Model No.
No. of phases	Phase current A	Output kW	Input	Outputs C13	Outputs C19	PDU length mm	TS IT enclosure frame	TS IT 482.6 mm (19") mounting frame	TS IT 482.6 mm (19") mounting angles	TE 8000 482.6 mm (19") mounting frame	
1	16	3.6	C20	12	–	775	1200	1200	1200	1200	<b>7955.901</b>
1	16	3.6	CEE	24	4	1320	1800	1800	1800	2000	<b>7955.910</b>
1	32	7.2	CEE	24	4	1360	1800	1800	1800	2000	<b>7955.911</b>
3	16	11	CEE	18	3	1150	1800	1800	1800	2000	<b>7955.931</b>
3	16	11	CEE	24	6	1450	1800	1800	1800	2000	<b>7955.932</b>
3	32	22	CEE	24	6	1655	1800	2000	2000	2000	<b>7955.933</b>

# Power Distribution Unit

## PDU UK, basic version

Power			Pin patterns			Dimensions	PDU installed in rack/min. enclosure height mm				Model No.
No. of phases	Phase current A	Output kW	Input	Outputs C13	Outputs C19	PDU length mm	TS IT enclosure frame	TS IT 482.6 mm (19") mounting frame	TS IT 482.6 mm (19") mounting angles	TE 8000 482.6 mm (19") mounting frame	
1	13	3	UK	6	–	440	1200	1200	1200	1200	<b>7955.510</b>
1	13	3	UK	8	–	535	1200	1200	1200	1200	<b>7955.511</b>
1	13	3	UK	10	–	640	1200	1200	1200	1200	<b>7955.512</b>
1	13	3	UK	12	–	745	1200	1200	1200	1200	<b>7955.513</b>

## PDU UK, metered version

Power			Pin patterns			Dimensions	PDU installed in rack/min. enclosure height mm				Model No.
No. of phases	Phase current A	Output kW	Input	Outputs C13	Outputs C19	PDU length mm	TS IT enclosure frame	TS IT 482.6 mm (19") mounting frame	TS IT 482.6 mm (19") mounting angles	TE 8000 482.6 mm (19") mounting frame	
1	13	3	UK	16	–	1210	1800	1800	1800	2000	<b>7955.520</b>
1	16	3.6	CEE	20	4	1590	1800	1800	2000	2000	<b>7955.521</b>
1	32	7.2	CEE	20	4	1730	2000	2000	2000	–	<b>7955.522</b>

## PDU UK, switched version

Power			Pin patterns			Dimensions	PDU installed in rack/min. enclosure height mm				Model No.
No. of phases	Phase current A	Output kW	Input	Outputs C13	Outputs C19	PDU length mm	TS IT enclosure frame	TS IT 482.6 mm (19") mounting frame	TS IT 482.6 mm (19") mounting angles	TE 8000 482.6 mm (19") mounting frame	
1	13	3	UK	16	–	1280	1800	1800	1800	2000	<b>7955.530</b>
1	16	3.6	CEE	16	4	1515	1800	1800	1800	2000	<b>7955.531</b>
1	32	7.2	CEE	16	4	1540	1800	1800	1800	2000	<b>7955.532</b>

## PDU UK, managed version

Power			Pin patterns			Dimensions	PDU installed in rack/min. enclosure height mm				Model No.
No. of phases	Phase current A	Output kW	Input	Outputs C13	Outputs C19	PDU length mm	TS IT enclosure frame	TS IT 482.6 mm (19") mounting frame	TS IT 482.6 mm (19") mounting angles	TE 8000 482.6 mm (19") mounting frame	
1	13	3	UK	16	–	1280	1800	1800	1800	2000	<b>7955.540</b>
1	16	3.6	CEE	16	4	1515	1800	1800	1800	2000	<b>7955.541</b>
1	32	7.2	CEE	16	4	1540	1800	1800	1800	2000	<b>7955.542</b>

## Slave PDU UK, managed version

Power			Pin patterns			Dimensions	PDU installed in rack/min. enclosure height mm				Model No.
No. of phases	Phase current A	Output kW	Input	Outputs C13	Outputs C19	PDU length mm	TS IT enclosure frame	TS IT 482.6 mm (19") mounting frame	TS IT 482.6 mm (19") mounting angles	TE 8000 482.6 mm (19") mounting frame	
1	13	3	UK	16	–	1240	1800	1800	1800	2000	<b>7955.940</b>
1	16	3.6	CEE	16	4	1430	1800	1800	1800	2000	<b>7955.941</b>
1	32	7.2	CEE	16	4	1500	1800	1800	1800	2000	<b>7955.942</b>

## PDU accessories

	Packs of	Model No.	Page
Slot cover for C13 jack, lockable	10 pc(s).	<b>7955.010</b>	495
Slot cover for C19 jack, lockable	10 pc(s).	<b>7955.015</b>	495
Connector lock for C14/C20 connector	20 pc(s).	<b>7955.020</b>	495
TE 7000/TE 8000 PDU mounting adaptor	2 pc(s).	<b>7000.688</b>	495

## CMC III sensors

CMC III/PDU sensor type	Packs of	Model No.	Page
Temperature sensor	1 pc(s).	<b>7030.110</b>	550
Temperature/humidity sensor (combi-sensor)	1 pc(s).	<b>7030.111</b>	550
Infrared access sensor	1 pc(s).	<b>7030.120</b>	550
Vandalism sensor	1 pc(s).	<b>7030.130</b>	550
CMC III CAN bus connection cable RJ 45 (length: 1 m)	1 pc(s).	<b>7030.091<sup>1)</sup></b>	557

<sup>1)</sup> Other cable lengths may be found under CMC III accessories on page 557

# Power Distribution Unit

## Configuration

PDU version	managed/ managed slave <sup>1)</sup>	switched	metered	basic
<b>Mechanical</b>				
<b>May be fitted in the zero-U space in the 600 mm wide TS IT, tool-free</b>	■	■	■	■
Colour coding of phases and fuse circuits (depending on PDU version)	■	■	■	■
Connection cable, static, 3 m, with CEE connector (IEC 60 309) or C20	■	■	■	■
<b>Connector lock for C13 and C19 pin patterns (optional)</b>	■	■	■	■
<b>Lockable cover for unneeded slots (for C13/C19)</b>	■	■	■	■
PDU slave version without display and Ethernet connection for use with PDU master and CMC III	■	–	–	–
<b>Electrical</b>				
<b>Power supply 110 V – 230 V/400 V, inherent power consumption approx. 6 – 14 W depending on product variant</b>	■	■	■	–
Rated current 16/32 A, single-phase/3-phase	■	■	■	■
Version additionally 63 A/3-phase (blade PDU, no Zero-U)	–	–	■	–
Electromagnetic circuit-breaker, 16 A, type C (only with 32/63 A PDU versions)	■	■	■	■
PDU with own power supply, no external power supply required	■	■	■	–
PDU power supply redundant across all phases (with 3-phase PDUs)	■	■	■	–
Emergency power supply to PDU web server via PoE (Power over Ethernet), remains accessible even in the event of a mains failure	■	■	–	–
Switching function per output slot	■	■	–	–
Sequential activation of the outputs once the power is resumed (avoids overload peaks)	■	■	–	–
Switching states are saved even in the event of a power failure	■	■	–	–
<b>Bistable relays/minimal power consumption</b>	■	■	–	–
Grouping (joint switching of several outputs)	■	■	–	–
<b>Measurement functions</b>				
Voltage (V), current (A), frequency (Hz)	■	■	■	–
Active power (kW), active energy (kWh), apparent power (kVA), apparent energy (kVAh)	■	■	■	–
<b>Power factor</b>	■	■	■	–
<b>Zero conductor current measurement/load imbalance detection</b>	■	■	■	–
Fuse monitoring (with 32/63 A versions)	■	■	■	–
Measurement per phase or infeed	–	■	■	–
Measurement per output slot	■	–	–	–
<b>Measurement accuracy 1% (kWh) to IEC 50 430-1</b>	■	■	■	–
<b>Connectivity/management functions</b>				
Powerful 400 MHz CPU and Linux operating system (not with slave versions)	■	■	■	–
Graphic OLED display 128 x 128 pixels (RGB) with back-lighting and energy-saving mode (display of output data and basic IP configuration)	■	■	■	–
Position sensor for display rotation (and correct visualisation in the RiZone DCIM software)	■	■	■	–
Multi-colour LEDs (green/red) to indicate switching states per individual output slot	–	■	–	–
Multi-colour LEDs (green/red) to indicate switching states and limits per individual output slot	■	–	–	–
Settable limits (warning/alarm)	■	■	■	–
Operating hours meter, total and cyclical (resettable)	■	■	■	–
Ethernet connection (RJ 45)	■	■	■	–
USB A-port for firmware update and data logging functions	■	■	■	–
CAN bus interface (RJ 45)	■	■	■	–
Web server (HTTP, HTTPS, SSL, SSH) NTP, Telnet	■	■	■	–
TCP/IP v4 and v6, DHCP	■	■	■	–
SNMP v1, v2c and v3, OPC-UA server, Modbus/TCP	■	■	■	–
FTP/SFTP (update/file transfer)	■	■	■	–
E-mail forwarding in case of alarm (SMTP)	■	■	■	–
<b>User administration including rights management</b>	■	■	■	–
<b>LDAP(S)/Radius/Active Directory connection</b>	■	■	■	–
Syslog server connection (max. 4 servers)	■	■	■	–
Plug & play drivers in the Rittal RiZone DCIM software	■	■	■	–
MB for linking into 3rd party software	■	■	■	–
Suitable for connection to Rittal CMC III system (Slave PDU)	■	–	–	–
<b>CMC III CAN bus sensors may be connected for ambient monitoring (max. 4 sensors)</b>	■	■	■	–
CMC III sensors that may be used: Temperature sensor, temperature/humidity sensor, infrared access sensor, vandalism sensor	■	■	■	–
<b>Ambient conditions</b>				
<b>Operating temperature</b>	0°C...+45°C	0°C...+45°C	0°C...+45°C	0°C...+45°C
Storage temperature	-25°C...+70°C	-25°C...+70°C	-25°C...+70°C	-25°C...+70°C
Ambient humidity % (non-condensing)	10 – 95	10 – 95	10 – 95	10 – 95
Protection category IP to IEC 60 529	IP 20	IP 20	IP 20	IP 20

<sup>1)</sup> managed slave without display/network

# Power Distribution Unit

## Power Distribution Unit, sample applications

### Master/slave principle

Up to 3 slave PDUs may be connected to one PDU.

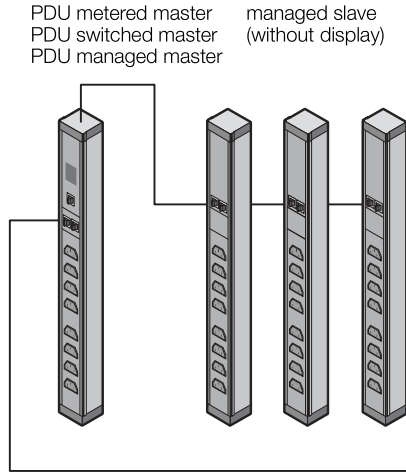

### Connection of CAN bus sensors

Up to 4 additional CMC III CAN bus sensors may be connected to the PDU master for ambient monitoring (temperature, humidity, access, vandalism).

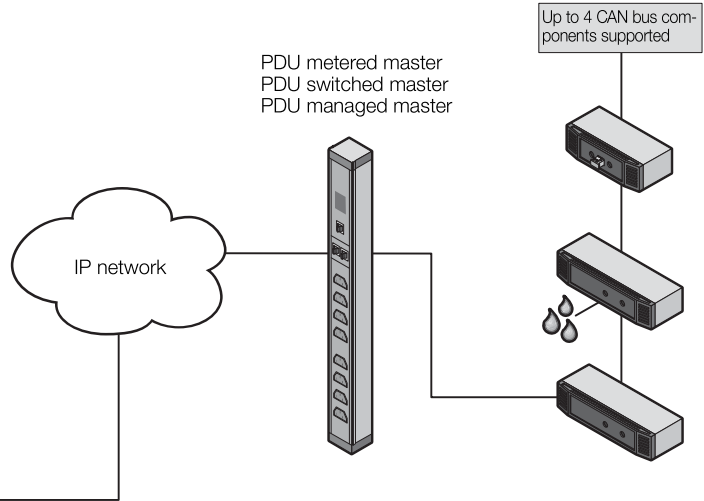

## Power Distribution Unit, allocation of fuses, phases, slots

Model No.	Infeed PDU	Fuse (type C16 A)	Phase 1		Phase 2		Phase 3	
			String 1 (F1)	String 1 (F2)	String 2 (F1)	String 2 (F2)	String 3 (F1)	String 3 (F2)
7955.X01	230 V/1~/16 A	-	12 x C13	-	-	-	-	-
7955.X10	230 V/1~/16 A	-	24 x C13 + 4 x C19	-	-	-	-	-
7955.X11	230 V/1~/32 A	2 x	12 x C13 + 2 x C19	12 x C13 + 2 x C19	-	-	-	-
7955.X31	400 V/3~/16 A	-	6 x C13 + 1 x C19	-	6 x C13 + 1 x C19	-	6 x C13 + 1 x C19	-
7955.X32	400 V/3~/16 A	-	8 x C13 + 2 x C19	-	8 x C13 + 2 x C19	-	8 x C13 + 2 x C19	-
7955.X33	400 V/3~/32 A	6 x	8 x C13	2 x C19	8 x C13	2 x C19	8 x C13	2 x C19
7955.X34	400 V/3~/32 A	6 x	6 x C13 + 1 x C19	6 x C13 + 1 x C19	6 x C13 + 1 x C19	6 x C13 + 1 x C19	6 x C13 + 1 x C19	6 x C13 + 1 x C19
7955.X35	400 V/3~/16 A	-	14 x C13	-	14 x C13	-	14 x C13	-
7955.X36	400 V/3~/32 A	6 x	8 x C13	8 x C13	8 x C13	8 x C13	8 x C13	8 x C13

## Power Distribution Unit international

Technical specifications		
Standards	Safety	EN 60 950-1
	EMC	EN 55 022/B, EN 61 000-4-2, EN 61 000-4-3, EN 61 000-6-2, EN 61 000-6-3
Low Voltage Directive		2014/35/EU
EMC Directive		2014/30/EU
MTBF (at 40°C)		70,000 hours
Protection category		IP 20 (IEC 60 529)
Protection category		3
Contamination level		2
Overvoltage category		II
Environmental properties		RoHS
Storage temperature		-25°C to +70°C
Ambient temperatures		0°C to +45°C
Ambient humidity		10 - 95% rel. humidity (non-condensing)
Connector latch C13 and C19		1 x (further optional DK 7955.020)
C13 covers included with supply		8 x (further optional DK 7955.010)
C19 covers included with supply		2 x (further optional DK 7955.015)
Warranty		24 months (from the date of manufacture)

## Power Distribution Unit international

Compact power distributor for use in IT servers and network enclosures. Please observe the relevant product dimensions and check whether the PDU can be installed in your preferred rack. The PDU dimensions and the minimum rack height required may be found in the ordering table in the Rittal Catalogue. The technical specifications listed below apply wholly or partially to the following PDU products:

- PDU metered (power measurement at the infeed or per phase. Without switching function)
- PDU switched (power measurement at the infeed or per phase. With switching function)
- PDU managed (power measurement per individual outgoing slot. With switching function)
- Slave PDU managed (like PDU managed, but without display and network interface, with CAN bus for connecting to CMC III or PDU metered/switched/managed)

Technical specifications apply to the following product variants:  
 PDU metered 7955.2XX, PDU switched 7955.3XX, PDU managed 7955.4XX

Technical specifications		
Input voltage range (L – N)	90 V – 260 (400) V AC, 50 – 60 Hz	
Input current	16 A/32 A/63 A (depending on variant)	
No. of phases	1 or 3 depending on PDU variant	
PDU inherent supply	Integral long-range SMPS, error-tolerant from all phases	
PDU power consumption	approx. 15 W	
Redundant power supply via PoE	Yes (with PDU switched, PDU managed)	
Marking of phases (3-phase PDUs only: L1, L2, L3)	Brown, black, grey	
Slots type EN 60 320/C13	Quantity depends on version, see Catalogue	
Slots type EN 60 320/C19	Quantity depends on version, see Catalogue	
No. of circuit-breakers	2 (single-phase) or 6 (3-phase) with 32 A version, 12 (3-phase) with 63 A version	
Electromagnetic circuit-breaker	16 A type C	
Slots individually switchable	Yes, only for PDU switched, PDU managed (bistable relay, minimal inherent consumption)	
Connector, PDU input	EN 60 309/CEE (depending on PDU version), EN 60 320-C20 for DK 7955.201/.301/.401	
Length of connection cable	3 m	
Connection cable type	H05-VV	
No. of wires	3/5 (single-phase/3-phase PDU)	
Cable cross-section	2.5 mm <sup>2</sup> /4.0 mm <sup>2</sup> (for 16 A/32 A versions)	
PDU enclosure width	44 mm (1 U) not for DK 7955.238	
PDU enclosure depth	62 mm/85 mm depending on product variant	
PDU enclosure height (length)	Depends on product variant	
PDU material	Aluminium, anodised in RAL 9005 (black)	
PDU mounting adaptor	Plastic, black	
Measurement functions (input/phase or output slot)	Values recorded	Voltage (V), current (A), frequency (Hz), active power (kW), active energy (kWh), apparent power (VA), power factor, neutral-conductor measurement/load imbalance detection, fuse monitoring (with 32 A/63 A versions)
	Voltage measurement range	90 V – 260 V
	Voltage resolution	0.1 V
	Voltage accuracy	2%
	Current measurement range	0 – 16/32/63 A (depending on PDU variant)
	Current resolution	0.1 A
	Current accuracy	2%
	Frequency accuracy	2%
	Active power (kW) accuracy	2%
	Apparent power (VA) accuracy	2%
	Active energy (kWh) accuracy	1%
	Power factor accuracy	2%
	Freely settable limit values for warning/alarm	Yes
	Operating hours meter	Yes
Display	OLED, RGB 128 x 128 pixels, LED per slot (for PDU switched, PDU managed)	
Network interface	RJ 45, integral Web server	
Supported protocols	HTTP, HTTPS, SSL, SSH, NTP, Telnet, TCP/IP v4 and v6, DHCP, DNS, NTP, Syslog, SNMP v1, v2c and v3, XML, FTP/SFTP (update/file transfer), e-mail forwarding (SMTP), OPC-UA server, Modbus/TCP	
User administration including rights management	Yes	
LDAP(S)/Radius/Active Directory connection	Yes	
USB port for firmware update and data logging functions	Yes	
CAN bus interface	RJ 45, for connecting sensors	
CAN sensor types	Temperature, temperature/humidity (combined), infrared access sensor, vandalism sensor	
Max. number of sensors per PDU	4, sensor configuration freely selectable, including 4 of the same type	
Plug & play drivers in the Rittal RiZone DCIM software	Yes	
Conformity	CE, UL, FCC Part 15	

We reserve the right to make technical modifications

# Power supply

## Socket strips

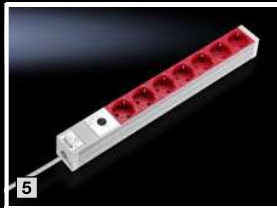

### Socket strips

#### in an aluminium duct

The socket strips in the aluminium duct are available in various lengths with different functional elements. Special attention has been devoted to practical, universal fastening:

Variable attachment facilities have been created with an angle bracket which may be inserted in four positions. Hence, for example, the 482 mm long socket strip may optionally be mounted on 482.6 mm (19") mounting angles, the 482.6 mm (19") mounting frame, on the enclosure frame, or in the rear section of the wall-mounted distributor. Without additional mounting accessories, the socket strip may be inserted into all sections with a 25 mm hole pattern. This makes selection much easier, as well as providing additional flexibility and saving on warehousing. Provision has also been made for cable routing of the infeed, and when mounting in the 482.6 mm (19") section there is adequate space to route the infeed between the socket strip and the profile rail without kinks.

The arrangement of the IEC 320 sockets at a 45° angle allows unrestricted use of angular connectors.

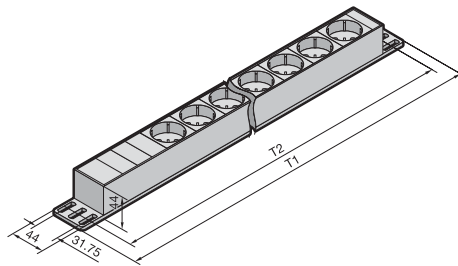

### Technical specifications:

#### Earthing-pin socket strips:

- Connector type F (CEE 7/3)
- Rated operating voltage: 250 V
- Connection cable: 2 m long H05VV-F3G1.5 without connector, [5] with connector

#### Belgium/France (UTE) socket strips:

- Connector type E (CEE 7/5)
- Rated operating voltage: 250 V
- Connection cable: 2 m long H05VV-F3G1.5 with wire end ferrules

#### Equipment connector strips (IEC 60 320-1/C13) socket strips:

- Rated operating voltage: 250 V
- Input: With C14 connector (H05VV-F3G1.0) or without connector (H05VV-F3G1.5), depending on the variant

#### Material:

- Aluminium section: Natural anodised
- Socket inserts: Polycarbonate

#### Supply includes:

- Socket strip
- Two mounting brackets
- Assembly parts

#### Standards:

- Earthing-pin socket: DIN 49 440
- IEC 320 socket: EN 60 320-2-2
- Overvoltage protection: DIN EN 61 643-11 (VDE 0675 Part 6-11)

#### Approvals:

- CE
- RoHS

#### Note:

- Depending on the application, we recommend use of a charging current reserve to prevent incorrect activation due to starting-current spikes

### Earthing-pin connector type

Version	Rated current A	Con-nection	No. of sockets	Attachment			Length (T1) mm	Mount- ing dimension (T2) mm <sup>1)</sup>	Packs of	Model No.
				Frame	Wall- mounted distribu- tor, hori- zontal	482.6 mm (19") level				
[1] Without rocker switch	16	Cable	3	■	-	-	262.6	232.5	1 pc(s)	<b>7240.110</b>
			7	■	■	■	482.6	452.5	1 pc(s)	<b>7240.210</b>
			12	■	-	-	658.6	628.5	1 pc(s)	<b>7240.310</b>
[2] With rocker switch	16	Cable	3	■	-	-	306.6	276.5	1 pc(s)	<b>7240.120</b>
			7	■	■	■	482.6	452.5	1 pc(s)	<b>7240.220</b>
[3] Overvoltage protection, type 3 and interference suppressor filter	16	Cable	5	■	■	■	482.6	452.5	1 pc(s)	<b>7240.230</b>
			9	■	-	-	658.6	628.5	1 pc(s)	<b>7240.330</b>
[4] Circuit-breaker, type B, 16 A, 2-pole	16	Cable	5	■	■	■	482.6	452.5	1 pc(s)	<b>7240.240</b>
[5] UPS strip, connection cable with 10 A IEC 320 connector, type E, with G fuse, 10 A	10	C14	7	■	■	■	482.6	452.5	1 pc(s)	<b>7240.260</b>
[6] RC circuit-breaker, 0.03 A, 2-pole, type A	16	Cable	5	■	■	■	482.6	452.5	1 pc(s)	<b>7240.280</b>
UTE sockets, type E with earthing pin (Belgium/France)	16	Cable	7	■	■	■	482.6	452.5	1 pc(s)	<b>7240.510</b>

<sup>1)</sup> Variable attachment distance within a range of 25 mm, the distance given is hole centre – hole centre of mounting bracket

### C13 connector type

Version	Rated current A	Con-nection	No. of sockets	Attachment			Length (T1) mm	Mount- ing dimension (T2) mm <sup>1)</sup>	Packs of	Model No.
				Frame	Wall- mounted distribu- tor, hori- zontal	482.6 mm (19") level				
For IEC 320 connectors	16	Cable	12	■	■	■	482.6	452.5	1 pc(s)	<b>7240.200</b>
For IEC 320 connectors with IEC 320 input	10	C14	9	■	■	■	482.6	452.5	1 pc(s)	<b>7240.201</b>

<sup>1)</sup> Variable attachment distance within a range of 25 mm, the distance given is hole centre – hole centre of mounting bracket



# Power supply

## Socket strips

### Socket strip

#### Earthing-pin, with plastic housing

Robust 8-way earthing-pin socket strip in a plastic housing. The strip may be mounted vertically on the enclosure frame or in the 482.6 mm (19") section. 2.5 U are required for 482.6 mm (19") installation. The earthing-pin inserts are arranged at an angle of 45° so that angular connectors are also easily used. The connection cable is attached to a terminal connection (behind a removable cover) in the socket strip. The socket strip has a terminal for an external earthing connection.

#### Technical specifications:

- Connector type F (CEE 7/3)
- Rated operating voltage: 230 V
- Rated current: 16 A
- Connection cable: Type H05VV-F3G1.5 (black) with wire end ferrules
- Length: 2 m
- Dimensions: W x H x D: 483 x 74 x 45 mm

Socket strip	Packs of	Model No.
8-way, earthing-pin	1 pc(s).	7000.630

#### Supply includes:

- 1 socket strip
- Assembly parts

#### Material:

- Plastic (grey/black)

#### Approvals:

- CE
- RoHS



### Socket strip

#### with power measurement

The socket strip 7x CEE 7/3 (type F - earthing-pin socket) with integrated display measures the power consumed by all connected equipment. The 482.6 mm (19") long socket strip may optionally be mounted on the 482.6 mm (19") mounting frame, on the enclosure frame or in the rear section of wall-mounted distributors. The installation bracket may be mounted in four different positions for variable mounting. Without additional mounting accessories, the socket strip may be inserted into all sections with a 25 mm hole pattern.

#### Installation options:

- Components with a 25 mm pitch pattern
- 482.6 mm (19") level
- Enclosure frame
- IT wall-mounted distributor, at the rear, horizontal (adequate width provided)

#### Benefits:

- Measurement accuracy of ± 5%

#### Functions:

- Measurement of current, voltage, frequency, active power, active energy and phase shift

#### Material:

- Aluminium section: Natural anodised
- Socket inserts: Polycarbonate

#### Colour:

- Socket RAL 7035

#### Supply includes:

- 1 socket strip
- 2 mounting brackets
- Assembly parts
- Operating instructions
- 3 m connection cable with wire end ferrules



Version	No. of sockets	Socket/jack (type)	Height mm	Length mm	Depth mm	Mounting dimension mm	Rated voltage	Phase current A	Packs of	Model No.
With display	7	D, earthing-pin (type F, CEE 7/3)	45	482.6	50	464.1	230 V AC	16	1 pc(s).	7240.301

# Power supply

## Socket strips



### Junction box

#### with multi-functional bracket

The angle bracket can be installed in all network enclosures in a system-compatible design. The junction box serves as a transfer point for the power supply to all equipment (fans, lights and socket strips). As well as being used as a junction box or interchange point, the bracket can also accommodate the enclosure internal thermostat 3110.000 or the hygrostat 3118.000, thanks to its integral holes.

**Material:**

- Sheet steel

**Colour:**

- RAL 7035

**Supply includes:**

- 1 junction box
- 1 bracket
- 6 m connection cable 3 x 1.5 mm<sup>2</sup> (flexible)

Packs of	Model No.
1 pc(s).	7280.035



### Socket

- For mounting on support rails TS 35/7.5 and TS35/15 to EN 60 715
- Uniform screw terminals from one side
- Enclosure width 45 mm

**Technical specifications:**

- Rated voltage: 250 V
- Rated current: 16 A

**Material:**

- Polyamide

**Colour:**

- Grey

**Standards:**

- DIN VDE 0620-1
- DIN 49 440-1

Version	Packs of	Model No.
Earthing-pin/CEE 7/3	2 pc(s).	2506.100



### Service socket

#### for enclosure frame attachment/16 A

Integration of a service socket within a separate supply circuit, independently of the IT network and UPS.

Simple installation via an angle bracket for attaching to the enclosure frame.

Type: Earthing contact/CEE 7/3

**Material:**

- Angle bracket: Sheet steel
- Socket: Plastic

**Surface finish:**

- Angle bracket: Zinc-plated

**Supply includes:**

- 1 angle bracket
- 1 damp-proof socket (IP 44)
- Assembly parts

Packs of	Model No.
1 pc(s).	7280.100



# Power supply

## Socket strips

### Energy-Box, 3 U, 482.6 mm (19")

#### Technical specifications:

- Depth-adjustable top hat rail for installed equipment to DIN 43 880, sizes 1 – 3 (e.g. to accommodate built-in sockets, circuit-breakers etc.)
- Cable clamping at the rear, one N and one PE rail on an insulated plinth
- Plastic hood including extension cover (UL94-V0)
- Maximum accommodation capacity of 22 HP (22 x 18 mm = 396 mm)
- Enclosure height: 3 U
- Enclosure depth: 155 mm
- Overall installation depth with C rail: 155 mm
- Dimensions:  
W x H x D: 483 x 132.5 x 155 mm

#### Colour:

- RAL 7035

#### Supply includes:

- 1 Energy-Box with fitted N and PE rails and brush strip
- 4 connection clamps, 35 mm<sup>2</sup>
- 18 connection clamps, 16 mm<sup>2</sup>
- 2 blanking covers
- 12 clips for cable strain relief
- Identification strips, self-adhesive

U	Packs of	Model No.
3	1 pc(s).	7480.035

Photo shows a configuration example with equipment not included in the scope of supply



### Energy-Box, 3 U, 482.6 mm (19")

#### Pull-out

#### Technical specifications:

- Depth-adjustable top hat rail for snap-in attachment of installed equipment to DIN 43 880 in sizes 1 – 3 (e.g. to accommodate built-in sockets, circuit-breakers etc.) or entire installation assemblies.
- Cable clamping at rear
- Two power distribution rails with connection clamps on insulated base/plinth
- Plastic hood including extension cover
- Maximum accommodation capacity of 22 HP (22 x 18 mm = 396 mm).
- Enclosure height: 3 U
- Enclosure depth: 223 mm
- Maximum extension: 220 mm
- Dimensions: W x H x D: 483.5 x 132 x 223 mm

#### Colour:

- RAL 7035

#### Supply includes:

- 1 Energy-Box with fitted N and PE rails and brush strip
- 4 connection clamps, 35 mm<sup>2</sup>
- 18 connection clamps, 16 mm<sup>2</sup>
- 2 blanking covers
- 12 clips for cable strain relief
- Identification strips, self-adhesive

U	Packs of	Model No.
3	1 pc(s).	7480.300

Photo shows a configuration example with equipment not included in the scope of supply



# Rittal – The System.

Faster – better – everywhere.

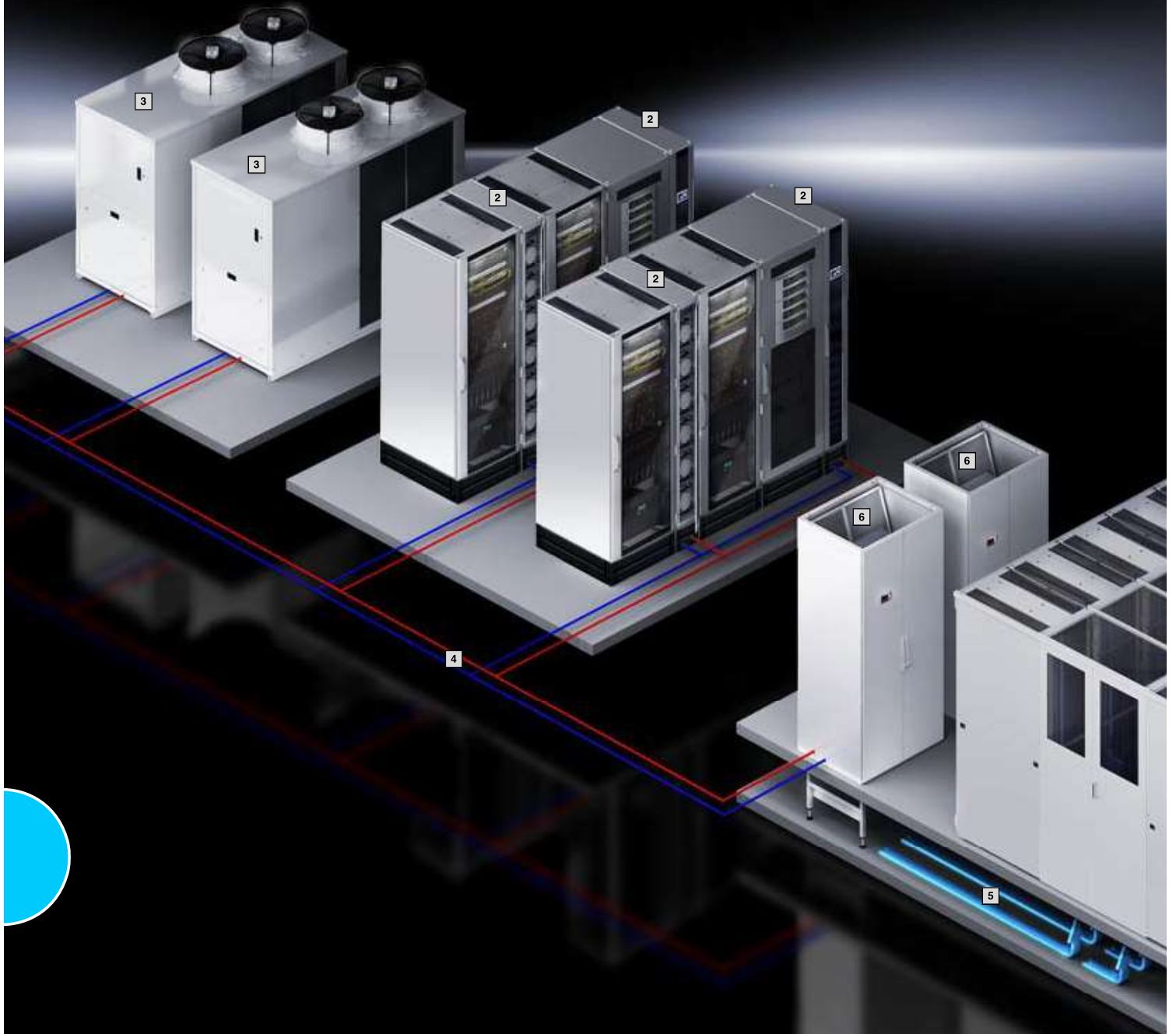

# IT cooling

## Liquid Cooling Unit/Package

LCU DX, single .....	518
LCU DX, redundant .....	520
LCP Rack DX .....	522
LCP Inline DX .....	523
LCP Rack CW .....	524
LCP Inline CW .....	525
Accessories for LCP/LCU .....	526

## Aisle containment

Aisle containment .....	529
-------------------------	-----

## Roof-mounted cooling units

For cooling IT equipment .....	530
--------------------------------	-----

## Small cooling units

Roof-mounted fan for the office sector .....	531
Fan mounting plate for TS IT, TE .....	532
Fan mounting plate .....	533
Fan expansion kit .....	533
Fan cross member .....	534
Fan expansion kit for fan cross member .....	534
Cover plates for fan panels .....	535
Vent cover .....	535

## Precision climate control equipment

Computer Room Air Conditioner CRAC DX/CW .....	537
--	-----

## Chillers for IT cooling

Overall cooling output 15 – 67 kW .....	538
Overall cooling output 77 – 261 kW .....	539
Overall cooling output 291 – 481 kW .....	540

## Your benefits

- State-of-the-art climate control technology, from cooling a single rack through to entire data centres
- Individual climate control concepts for rack, suite and room cooling
- Enhanced security plus superior energy and cost efficiency
- Optimisation with aisle containment and cross-system control concepts
- Energy-efficient cooling using IT chillers
- Minimisation of operating costs with free cooling
- Environmentally friendly, thanks to resource savings and reduced CO<sub>2</sub> emissions
- Planning, assembly, commissioning and servicing – all from a single source!

## Sample applications

- 1 Aisle containment, see page 529
- 2 Liquid Cooling Package LCP, see page 514
- 3 IT chiller with integral free cooling, see page 538
- 4 Pipework
- 5 Raised floor for cold air supply
- 6 CRAC (partner product)



# Overview of LCP/LCU

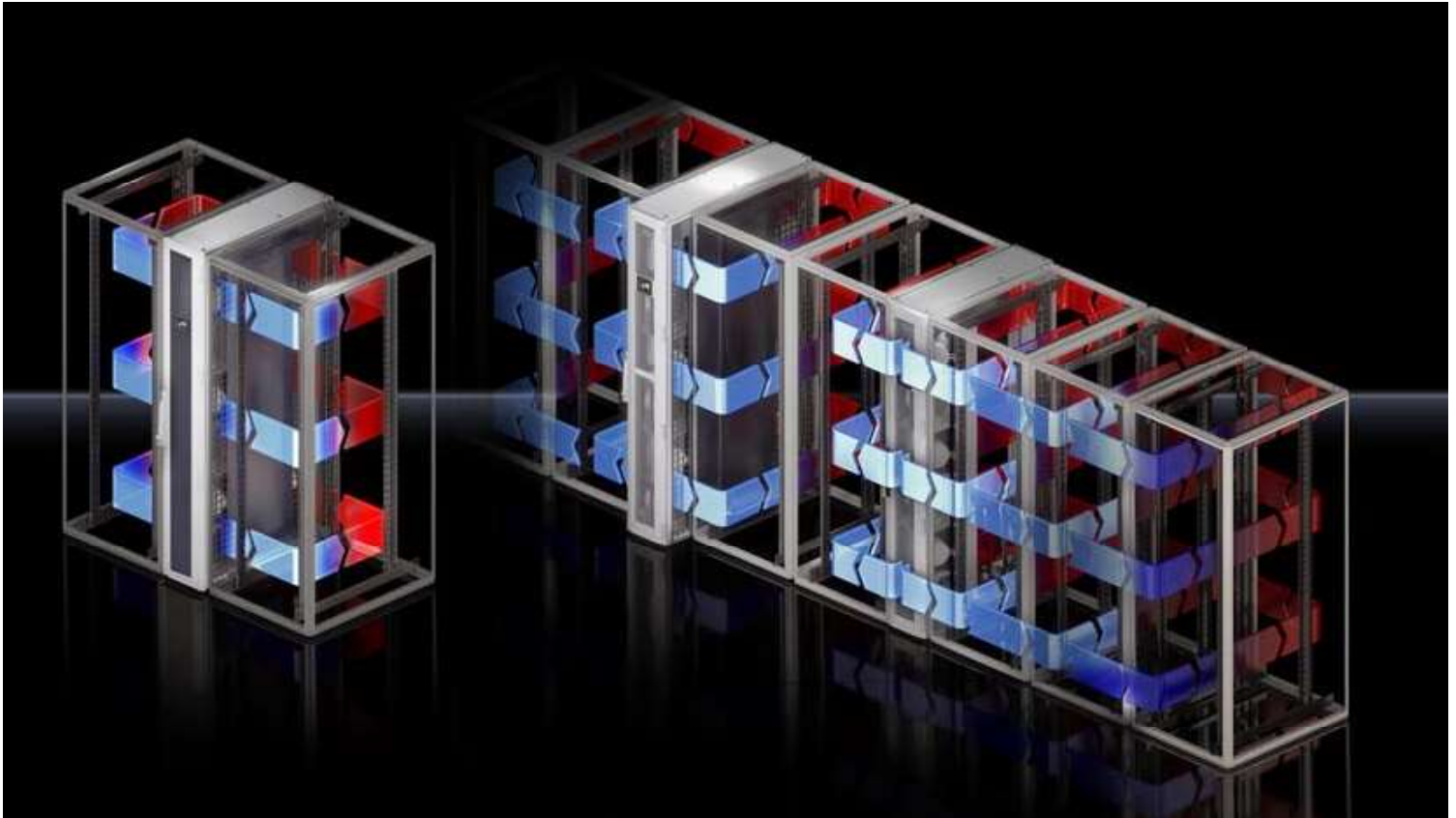

<b>Rack cooling</b> Water-based	<b>Bayed suite cooling</b> Water-based	
<p>Data centres support corporate processes at ever-higher outputs. The packing density in computer systems is increasing, and processor capacity is growing. This leads to a continuous rise in heat development. Keep temperatures at a constant level with the highly efficient Rittal Liquid Cooling Packages (LCP). With optimised operating costs, our LCPs precisely and effortlessly dissipate heat losses of up to 55 kW per enclosure.</p>	<p>Rittal bayed suite cooling with the LCP Inline CW is extremely powerful, and the ideal climate control solution for exceptionally high cooling demands, particularly when server racks cannot be cooled via the room air-conditioning. Alternatively, bayed suite cooling can be used to support the existing air-conditioning system in the room or for transforming existing structures into server rooms. A raised floor is not necessary for the operation of bayed suite cooling.</p>	
<p><b>LCP Rack CW</b></p> <ul style="list-style-type: none"> <li>■ Cooling output from 10 kW to 55 kW</li> <li>■ Energy saving with high water inlet temperatures (more free cooling)</li> <li>■ Minimised operating costs with efficient EC fan technology</li> <li>■ Spatial separation of cooling and server rack</li> <li>■ Integral condensate and leak management</li> <li>■ Sophisticated control concept including online connection</li> <li>■ Optional cooling of one or two server racks</li> <li>■ Simple representation of redundancies</li> <li>■ Assembly- and service-friendly</li> <li>■ Integration into RiZone (data centre management software)</li> </ul>	<p><b>LCP Inline CW</b></p> <ul style="list-style-type: none"> <li>■ Cooling output from 10 kW to 55 kW</li> <li>■ Cooling of several server racks</li> <li>■ Energy saving with high water inlet temperatures (more free cooling)</li> <li>■ Minimised operating costs with efficient EC fan technology</li> <li>■ Spatial separation of cooling and server rack</li> <li>■ Integral condensate and leak management</li> <li>■ Sophisticated control concept including online connection</li> <li>■ Assembly- and service-friendly</li> <li>■ Increased performance and efficiency in conjunction with Rittal aisle containment</li> <li>■ Integration into RiZone (data centre management software)</li> <li>■ Set-forward variant for ideal air distribution (cold air curtain)</li> <li>■ Flush variant for confined spaces (narrow cold aisle)</li> </ul>	

# Overview of LCP/LCU

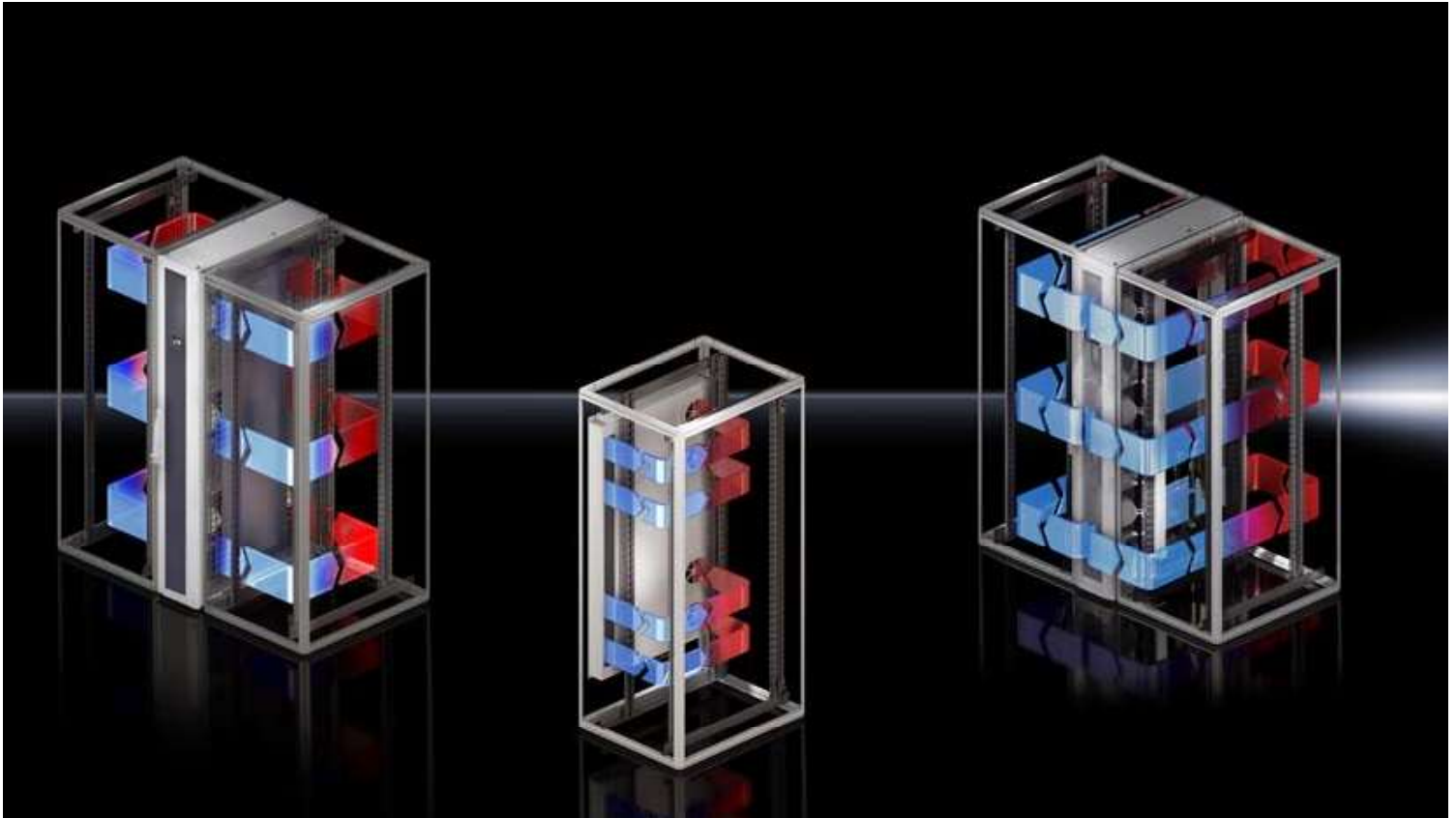

Rack cooling Refrigerant-based		Bayed suite cooling Refrigerant-based	
<p>The ideal cooling solution for small to medium IT installations. Up to 6.5 kW heat load can be dissipated with the inverter-controlled LCU DX split cooling unit. The LCP rack DX has a cooling output of 12 kW and is capable of cooling up to 2 server racks. Both units allow IT-compatible cooling and regulate the server inlet air temperature. The external unit dissipates thermal energy directly to the exterior air, thereby preventing the server rack installation location from heating up.</p>		<p>Both the LCP Inline DX and the LCP Inline CW support the cooling of bayed enclosure suites. A raised floor is not required for the LCP Inline DX. The cooling output is 12 kW. The Inline units are generally used in combination with aisle containment.</p>	
<p><b>LCP Rack DX</b></p> <ul style="list-style-type: none"> <li>■ Cooling output 12 kW</li> <li>■ Refrigerant R410a</li> <li>■ Minimised operating costs with efficient EC fan technology</li> <li>■ Spatial separation of cooling and server rack</li> <li>■ Integral condensate and leak management</li> <li>■ Sophisticated control concept including online connection</li> <li>■ Optional cooling of one or two server racks</li> <li>■ Simple representation of redundancies</li> <li>■ Assembly- and service-friendly</li> <li>■ Integration into RiZone (data centre management software)</li> <li>■ Cost-effective installation by laying small-diameter refrigerant lines</li> </ul>	<p><b>LCU DX</b></p> <ul style="list-style-type: none"> <li>■ Cooling output 3 kW and 6.5 kW</li> <li>■ Single and redundant version</li> <li>■ Refrigerant R410a</li> <li>■ Maximum energy efficiency due to EC fan technology and output-regulated compressor</li> <li>■ Space-saving installation of the internal unit (evaporator coil) in the server rack</li> </ul>	<p><b>LCP Inline DX</b></p> <ul style="list-style-type: none"> <li>■ Cooling output 12 kW</li> <li>■ Cooling of several server racks</li> <li>■ Refrigerant R410a</li> <li>■ Minimised operating costs with efficient EC fan technology</li> <li>■ Spatial separation of cooling and server rack</li> <li>■ Integral condensate and leak management</li> <li>■ Sophisticated control concept including online connection</li> <li>■ Assembly- and service-friendly</li> <li>■ Increased performance and efficiency in conjunction with Rittal aisle containment</li> <li>■ Integration into RiZone (data centre management software)</li> </ul>	

# Efficient cooling with no loss of space





## The benefits

- Cooling of TS IT racks and Micro Data Centers
- Space-saving installation of the internal unit between the 482.6 mm (19") level and side panel
- External unit is sited outside the building
- Maximum energy efficiency by cooling the individual rack, rather than the whole room
- Efficient operation thanks to EC fan technology
- High availability designed for continuous, 24/7 operation

## Technology

- Refrigerant-based split cooling unit comprised of an internal unit (evaporator coil) and an external unit with integral compressor (inverter-controlled)
- Optimum support of IT-compatible, "front-to-back" air routing
- Optimum adaptation of the compressor output to the current heat load of the IT rack with inverter control
- The internal and external unit are connected with refrigerant, data and supply lines
- Absorbed thermal energy is emitted via the external unit directly to the ambient air
- Control of the server air inlet temperature
- High level of fail-safeness thanks to availability of single and redundant variant
- Ultimate security with optional alarm forwarding via CMC III

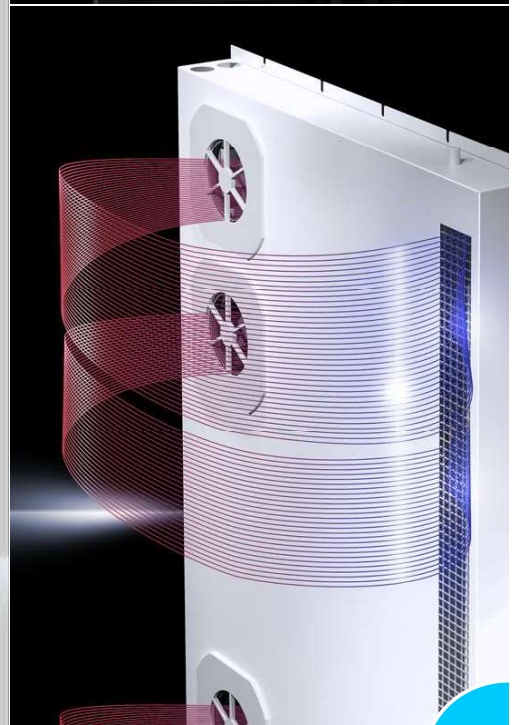

# Liquid Cooling Unit

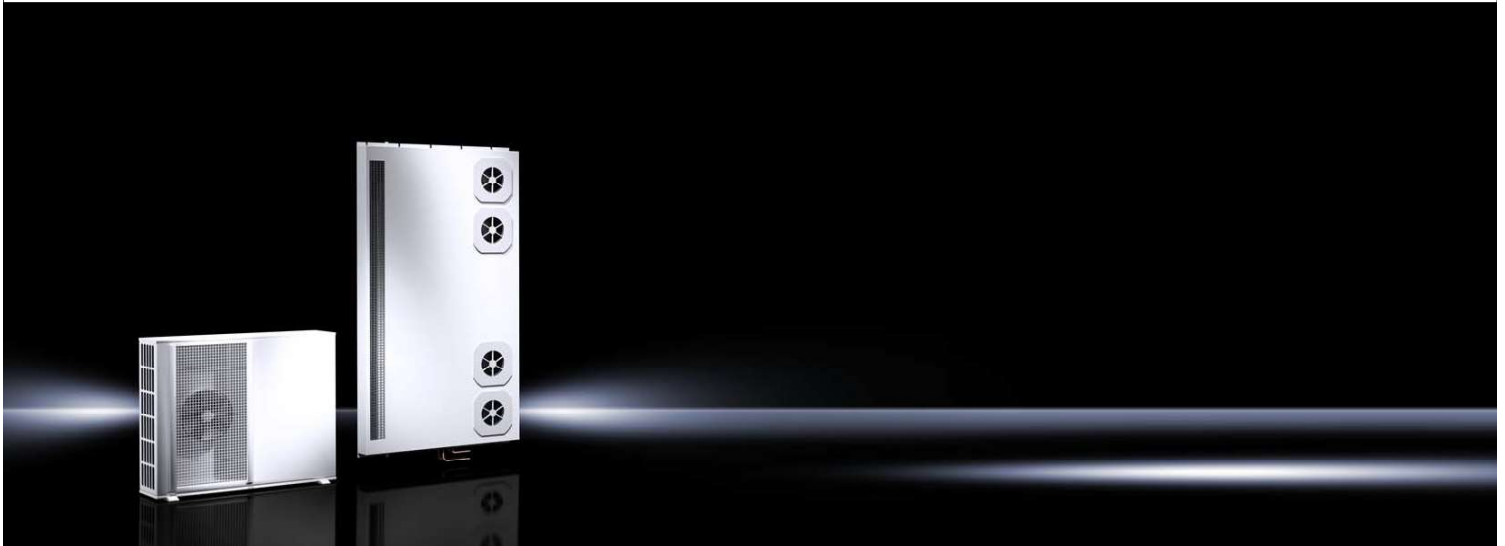

Network/server enclosures TS IT Page 100 Micro Data Center Page 566

## Applications:

- Cooling unit for TS IT server enclosures and for Micro Data Center

## Benefits:

- Space-saving solution by installing the internal unit in the TS IT server enclosure or the Micro Data Center
- Maximum energy efficiency due to EC fan technology and IT-based control
- Control of the server inlet temperature
- The inverter-controlled compressor adapts the cooling output to the current heat loss inside the enclosure
- Absorbed thermal energy is emitted directly to the ambient air at the (inverter-controlled) external unit's location, without heating up the installation room

## Functions:

- The device supports front-to-back air routing typical of IT applications, and regulates the server inlet temperature to the set value

## Colour:

- Internal unit: RAL 7035
- External unit: white

## Protection category IP to IEC 60 529:

- Internal unit IP 20
- External unit IP X4

## Supply includes:

- Internal unit (evaporator coil)
- External unit (inverter-controlled)
- 482.6 mm (19") mounting trim panel with display and control components
- Condensate hose

## Note:

- Below the operating limit, fluctuations in the air inlet temperature are possible
- The electrical connection is made on the external unit. The internal unit is supplied by the external unit.

## Installation in TS IT:

- 482.6 mm (19") levels must be designed as mounting angles and offset in the width by 50 mm off-centre
- The front distance between the 482.6 mm (19") mounting angles and the front edge of the TS frame must be at least 100 mm
- Not suitable for combination with 482.6 mm (19") mounting frame
- Two punched sections with mounting flanges are required for attachment on the inner mounting level
- To separate the hot/cold zones within an enclosure, an air baffle plate for TS IT is required
- A Flex-Block base/plinth is required to route the cable downwards

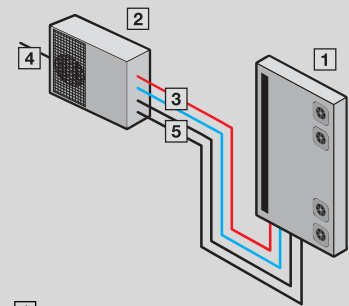

- 1 Internal unit
- 2 External unit
- 3 Refrigerant lines
- 4 Power supply
- 5 Data cable

## LCU DX, single

Model No.	Packs of	3311.490	3311.492	Page
<b>Useful cooling output L22 L35 kW</b>		<b>3</b>	<b>6.5</b>	
Modulation range kW		1 - 3	3 - 6.5	
For enclosure width mm		800	800	
For enclosure height mm		≥ 1800	≥ 1800	
For enclosure depth mm		≥ 1000	≥ 1000	
External unit, W x H x D mm		810 x 558 x 310	845 x 700 x 320	
Internal unit, W x H x D mm		105 x 1550 x 820	105 x 1550 x 820	
Type of electrical connection		Connection clamp	Connection clamp	
Rated operating voltage V, ~, Hz		230, 1~, 50	230, 1~, 50	
Rated current (max.) A		7	15.9	
Pre-fuse A		16	20	
Duty cycle %		100	100	
Cooling medium		R410a	R410a	
Sound pressure level at a distance of 10 m (external unit) dB(A)		40	40	
Operating temperature range (external unit)		-20°C...+45°C	-20°C...+45°C	
Weight as delivered kg		116.0	126.0	
<b>Accessories</b>				
Refrigerant lines	1 pc(s).	3311.495	3311.496	526

## Any questions about our services or maintenance agreements?

Do you need an individual, personal consultation or a service quote? Our service specialists will be happy to assist you. Please direct enquiries to the local Rittal Service organisation, either by e-mail or phone. [www.rittal.com/contact](http://www.rittal.com/contact)

**Rittal Service**



- Manufacturers' warranty
- Configuration and assembly
- Inspection
- Climate control pipework
- Commissioning
- Leak test
- Modernisation
- Maintenance
- Service agreements
- Spare parts
- Response time
- Wearing parts

# Liquid Cooling Unit



Network/server enclosures TS IT Page 100 Micro Data Center Page 566

### Applications:

- Cooling unit for TS IT server enclosures and for Micro Data Center in a redundant design

### Benefits:

- Space-saving solution by installing the redundantly designed internal unit in the TS IT server enclosure or the Micro Data Center
- Maximum energy efficiency due to EC fan technology and IT-based control
- Control of the server inlet temperature
- The inverter-controlled compressor adapts the cooling output to the current heat loss inside the enclosure
- Absorbed thermal energy is emitted directly to the ambient air at the (inverter-controlled) external unit's location, without heating up the installation room

### Functions:

- The redundant variants have two cooling circuits and controllers inside the internal unit, plus two inverter-regulated external units. The fault and operating hours changeover allows regular switching between the two external units, and ensures automatic changeover in the event of a malfunction or failure.
- The device supports front-to-back air routing typical of IT applications, and regulates the server inlet temperature to the set value

### Colour:

- Internal unit: RAL 7035
- External unit: white

### Protection category IP to IEC 60 529:

- Internal unit IP 20
- External unit IP X4

### Supply includes:

- Internal unit (evaporator coil)
- 2 external units (inverter-controlled)
- 482.6 mm (19") mounting trim panel with display and control components
- Condensate hose

### Note:

- Below the operating limit, fluctuations in the air inlet temperature are possible
- The electrical connection is made on the external unit. The internal unit is supplied by the external unit.
- A separate power supply may be needed, depending on the external unit

### Installation in TS IT:

- 482.6 mm (19") levels must be designed as mounting angles and offset in the width by 50 mm off-centre
- The front distance between the 482.6 mm (19") mounting angles and the front edge of the TS frame must be at least 100 mm
- Not suitable for combination with 482.6 mm (19") mounting frame
- Two punched sections with mounting flanges are required for attachment on the inner mounting level
- To separate the hot/cold zones within an enclosure, an air baffle plate for TS IT is required
- A Flex-Block base/plinth is required to route the cable downwards

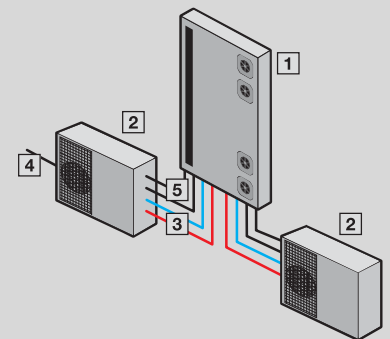

- 1 Internal unit
- 2 External unit
- 3 Refrigerant lines
- 4 Power supply
- 5 Data cable

## LCU DX, redundant

Model No.	Packs of	3311.491	3311.493	Page
<b>Useful cooling output L22 L35 kW</b>		<b>3</b>	<b>6.5</b>	
Modulation range kW		1 - 3	3 - 6.5	
For enclosure width mm		800	800	
For enclosure height mm		≥ 1800	≥ 1800	
For enclosure depth mm		≥ 1000	≥ 1000	
External unit, W x H x D mm		810 x 558 x 310	845 x 700 x 320	
Internal unit, W x H x D mm		105 x 1550 x 820	105 x 1550 x 820	
Type of electrical connection		Connection clamp	Connection clamp	
Rated operating voltage V, ~, Hz		230, 1~, 50	230, 1~, 50	
Rated current (max.) A		7	15.9	
Pre-fuse A		16	20	
Duty cycle %		100	100	
Cooling medium		R410a	R410a	
Sound pressure level at a distance of 10 m (external unit) dB(A)		40	40	
Operating temperature range (external unit)		-20°C...+45°C	-20°C...+45°C	
Weight as delivered kg		154.0	174.0	
<b>Accessories</b>				
Refrigerant lines	1 pc(s).	3311.495	3311.496	526



## Rittal data centre quick check – know what's going on!

On request, as part of a maintenance order or service agreement, we will carry out the following quick check on your data centre, free of charge:

- Perform an evaluation
- Assess the obsolescence risk
- Analyse energy efficiency
- Allow for current legislation and regulations
- Offer solutions

Please direct enquiries to the local Rittal Service organisation, either by e-mail or phone. [www.rittal.com/contact](http://www.rittal.com/contact)

Rittal Service

# Liquid Cooling Package



Accessories for LCP Page 526 Network/server enclosures TS IT Page 100 System accessories Page 613

## Benefits:

- Maximum energy efficiency due to EC fan technology and IT-based control
- Minimal pressure loss at the air end, which in turn minimises the power consumption of the fans
- Control of the server inlet temperature
- Thanks to the speed-regulated compressor, the cooling output is ideally adapted to actual requirements
- With redundant temperature sensor integrated at the air end as standard

- Specific maintenance of the LCP DX due to separation of cooling and server racks
- Absorbed thermal energy is emitted to the ambient air at the external condenser location, without heating up the installation room
- Ideal for IT cooling of small and medium-sized locations
- One or two racks can be cooled separately
- Direct connection of the unit via SNMP over Ethernet

## Functions:

- The LCP draws in the air at the sides at the rear of the server enclosures, cools it using high-performance compact impellers, and blows the cooled air back into the front part of the server enclosure at the sides

## Temperature control:

- Linear fan control
- Inverter-controlled compressor

## Colour:

- RAL 7035

## Protection category IP to IEC 60 529:

- IP 20

## Cooling medium:

- R410a

## Optional:

- Humidifier
- Reheater
- Condensate drain pump
- Higher cooling output
- Low-temperature/high-temperature condenser (-40°C / +55°C)

## Note:

- Variant with UL approval available on request

Photo shows a configuration example with equipment not included in the scope of supply

## LCP Rack DX

Model No.	Packs of	3311.410	3311.420	Page
<b>Total cooling output/Number of fan modules required kW</b>		<b>12 / 4</b>	<b>12 / 4</b>	
Width mm		300	300	
Height mm		2000	2000	
Depth mm		1000	1200	
Type of electrical connection		Connection clamp	Connection clamp	
Installation in bayed enclosure suite		Flush	Flush	
Rated operating voltage V, ~, Hz		400, 3~, 50 380 - 480, 3~, 60	400, 3~, 50 380 - 480, 3~, 60	
Pre-fuse (I) A		20	20	
Air throughput at max. cooling output m³/h		4800	4800	
Fans may be exchanged with the system operational		■	■	
EC fan		■	■	
Rated current max. A		7.5	7.5	
Duty cycle %		100	100	
Operating temperature range		+15°C...+35°C	+15°C...+35°C	
Weight as delivered kg		207.0	227.0	
<b>Also required</b>				
Condenser unit	1 pc(s).	3311.360	3311.360	526

# Liquid Cooling Package



Accessories for LCP Page 526 Network/server enclosures TS IT Page 100 Aisle containment Page 529

## Benefits:

- Maximum energy efficiency due to EC fan technology and IT-based control
- Minimal pressure loss at the air end, which in turn minimises the power consumption of the fans
- Temperature monitoring and control
- With redundant temperature sensor integrated at the air end as standard
- Minimal area load due to low weight

- Absorbed thermal energy is emitted to the ambient air at the external condenser location, without heating up the installation room
- Ideal for IT cooling of small and medium-sized locations
- One or two racks can be cooled separately
- Thanks to the speed-regulated compressor, the cooling output is ideally adapted to actual requirements
- Specific maintenance of the LCP DX due to separation of cooling and server racks
- Direct connection of the unit via SNMP over Ethernet

## Functions:

- The LCP is designed for siting within a bayed enclosure suite. Hot air is drawn in from the aisle at the rear of the device, cooled by the high-capacity compact impellers, and blown back into the room or cold aisle after cooling

## Temperature control:

- Linear fan control
- Inverter-controlled compressor

## Colour:

- RAL 7035

## Protection category IP to IEC 60 529:

- IP 20

## Cooling medium:

- R410a

## Optional:

- Humidifier
- Reheater
- Condensate drain pump
- Higher cooling output
- Air filter
- Low-temperature/high-temperature condenser (-40°C / +55°C)

## Note:

- Variant with UL approval available on request

Photo shows a configuration example with equipment not included in the scope of supply

## LCP Inline DX

Model No.	Packs of	3311.430	3311.440	Page
<b>Total cooling output/Number of fan modules required kW</b>		<b>12 / 4</b>	<b>12 / 4</b>	
Width mm		300	300	
Height mm		2000	2000	
Depth mm		1000	1200	
Type of electrical connection		Connection clamp	Connection clamp	
Installation in bayed enclosure suite		Flush	Flush	
Rated operating voltage V, ~, Hz		400, 3~, 50 380 - 480, 3~, 60	400, 3~, 50 380 - 480, 3~, 60	
Pre-fuse (T) A		20	20	
Air throughput at max. cooling output m <sup>3</sup> /h		4800	4800	
Fans may be exchanged with the system operational		■	■	
EC fan		■	■	
Rated current max. A		7.5	7.5	
Duty cycle %		100	100	
Operating temperature range		+15°C...+35°C	+15°C...+35°C	
Weight as delivered kg		208.0	233.5	
<b>Also required</b>				
Condenser unit	1 pc(s).	3311.360	3311.360	526

# Liquid Cooling Package



Accessories for LCP Page 526 Chillers for IT cooling Page 538 Network/server enclosures TS IT Page 100

## Benefits:

- Maximum energy efficiency due to EC fan technology and IT-based control
- Minimal pressure loss at the air end, which in turn minimises the power consumption of the fans
- Control of the server inlet temperature
- With redundant temperature sensor integrated at the air end as standard
- Optimum adaptability due to dynamic, continuous control of the cold water volume flow
- By using high water inlet temperatures, the proportion of indirect free cooling is increased, which in turn reduces operating costs

- Targeted cooling output due to modular fan units
- Fan modules configurable as n+1 redundancy
- Standard 3-phase connection for electrical redundancy
- The separation of cooling and enclosure prevents the ingress of water into the server enclosure
- Up to 55 kW cooling output on a footprint of just 0.36 m<sup>2</sup>
- Minimal area load due to low weight

## Functions:

- The LCP draws in the air at the sides at the rear of the server enclosures, cools it using high-performance compact impellers, and blows the cooled air back into the front part of the server enclosure at the sides

## IT monitoring:

- Monitoring of all system-relevant parameters such as server air intake temperature, server waste air temperature, water inlet/return temperature, water flow, cooling output, fan speed, leakage
- Direct connection of the unit via SNMP over Ethernet

## Temperature control:

- Linear fan control
- Two-way control valve

## Colour:

- RAL 7035

## Protection category IP to IEC 60 529:

- IP 20

## Cooling medium:

- Water

## Optional:

- Fully integrated fire detection and extinguisher system
- Automatic server enclosure door opening
- Various sensors
- Racks 2200 mm high

Photo shows a configuration example with equipment not included in the scope of supply

## LCP Rack CW

Model No.	Packs of	3311.130	3311.230	3311.260	Page
<b>Total cooling output/Number of fan modules required kW</b>		<b>10 / 1 20 / 2 30 / 3</b>	<b>10 / 1 20 / 2 30 / 3</b>	<b>40 / 4 45 / 5 55 / 6</b>	
Number of fan modules in supplied state		1	1	4	
Width mm		300	300	300	
Height mm		2000	2000	2000	
Depth mm		1000	1200	1200	
Type of electrical connection		Connector	Connector	Connector	
Installation in bayed enclosure suite		Flush	Flush	Flush	
Rated operating voltage V, ~, Hz		230, 1~, 50/60 400, 3~, 50/60	230, 1~, 50/60 400, 3~, 50/60	230, 1~, 50/60 400, 3~, 50/60	
Air throughput at max. cooling output m <sup>3</sup> /h		4800	4800	8000	
Fans may be exchanged with the system operational		■	■	■	
EC fan		■	■	■	
Water inlet temperature °C		15	15	15	
Permissible operating pressure (p. max.) bar		6	6	6	
Duty cycle %		100	100	100	
Water connection		DN 40 (G 1½" external thread)	DN 40 (G 1½" external thread)	DN 40 (G 1½" external thread)	
Weight as delivered kg		194.0	210.0	235.0	
<b>Accessories</b>					
Fan module	1 pc(s).	3311.011	3311.011	3311.011	528
Touchscreen display, colour	1 pc(s).	3311.030	3311.030	3311.030	526
Connection hose	2 pc(s).	3311.040	3311.040	3311.040	527



# Liquid Cooling Package



Accessories for LCP Page 526 Chillers for IT cooling Page 538 Network/server enclosures TS IT Page 100

## Benefits:

- Maximum energy efficiency due to EC fan technology and IT-based control
- Minimal pressure loss at the air end, which in turn minimises the power consumption of the fans
- Optimum adaptability due to dynamic, continuous control of the cold water volume flow
- By using high water inlet temperatures, the proportion of indirect free cooling is increased, which in turn reduces operating costs
- Targeted cooling output due to modular fan units
- Fan modules configurable as n+1 redundancy

- Standard 3-phase connection for electrical redundancy
- With redundant temperature sensor integrated at the air end as standard
- The separation of cooling and enclosure prevents the ingress of water into the server enclosure
- Minimal area load due to low weight

## Functions:

- The hot air is drawn in from the room or hot aisle at the rear of the device and expelled at the front into the cold aisle after cooling. With this product, a raised floor is not necessary

## IT monitoring:

- Monitoring of all system-relevant parameters such as server air intake temperature, server waste air temperature, water inlet/return temperature, water flow, cooling output, fan speed, leakage
- Direct connection of the unit via SNMP over Ethernet
- Integration into RiZone

## Temperature control:

- Linear fan control
- Two-way control valve

## Colour:

- RAL 7035

## Protection category IP to IEC 60 529:

- IP 20

## Cooling medium:

- Water

## Optional:

- Various sensors
- Racks 2200 mm high

Photo shows a configuration example with equipment not included in the scope of supply

## LCP Inline CW

Model No.	Packs of	3311.530	3311.540	3311.560	Page
<b>Total cooling output/Number of fan modules required kW</b>		<b>10 / 1 20 / 2 30 / 3</b>	<b>18 / 2 27 / 3 30 / 4</b>	<b>40 / 4 45 / 5 55 / 6</b>	
Number of fan modules in supplied state		1	2	4	
Width mm		300	300	300	
Height mm		2000	2000	2000	
Depth mm		1200	1200	1200	
Type of electrical connection		Connector	Connector	Connector	
Installation in bayed enclosure suite		Set forward	Flush	Set forward	
Rated operating voltage V, ~, Hz		230, 1~, 50/60 400, 3~, 50/60	230, 1~, 50/60 400, 3~, 50/60	230, 1~, 50/60 400, 3~, 50/60	
Air throughput at max. cooling output m <sup>3</sup> /h		4800	4800	8000	
Fans may be exchanged with the system operational		■	■	■	
EC fan		■	■	■	
Permissible operating pressure (p. max.) bar		6	6	6	
Duty cycle %		100	100	100	
Water connection		DN 40 (G 1½" external thread)	DN 40 (G 1½" external thread)	DN 40 (G 1½" external thread)	
Water inlet temperature °C		15	15	15	
Weight as delivered kg		216.0	235.0	236.0	
<b>Accessories</b>					
Fan module	1 pc(s).	3311.011	3311.011	3311.011	528
Touchscreen display, colour	1 pc(s).	3311.030	3311.030	3311.030	526
Connection hose	2 pc(s).	3311.040	3311.040	3311.040	527
Rear adaptor	1 pc(s).	3311.080	–	3311.080	527

# Liquid Cooling Unit/Package

## Accessories



### Refrigerant lines

#### for LCU DX

For connecting the internal and external unit of the LCU DX. Consisting of intake gas line and liquid line. The refrigerant lines are insulated.

Design	Length m	Product-specific scope of supply	Packs of	Model No.
LCU DX 3 kW	20	Intake gas line 1/2" Liquid line 1/4"	1 pc(s).	<b>3311.495</b>
LCU DX 6.5 kW	20	Intake gas line 5/8" Liquid line 3/8"	1 pc(s).	<b>3311.496</b>



### Touchscreen display, colour

#### for LCP Rack/Inline CW

The display offers the opportunity of directly monitoring key functions of the LCP, and implementing settings.

Packs of	Model No.
1 pc(s).	<b>3311.030</b>



### Condenser unit

#### for LCP DX

The condenser unit is needed to operate the refrigerant-based LCPs, and comprises the external condenser and fan. The unit is designed for two separate door systems.

#### Supply includes:

- Assembly parts

W x H x D mm	Temperature control	Number of fans	Rated operating voltage V, ~, Hz	Refrigerant	Weight kg	Packs of	Model No.
1303 x 578 x 510	Speed-controlled fan	2	230, 1~, 50/60	R410a	34.0	1 pc(s).	<b>3311.360</b>



### Vertical shielding

#### for TS IT

To block the airflow on the left and right of the 482.6 mm (19") level, for enclosure height 2000 mm.

#### Design:

- Self-adhesive on one side

#### Material:

- Cellular PU foam
- Flame-inhibiting to UL 94 (HF1)

Sealing between	W x H x D mm	For enclosure width mm	Packs of	Model No.
LCP and 482.6 mm (19") level	210 x 1915 x 110	800	1 pc(s).	<b>3301.320</b>
LCP and 482.6 mm (19") level	110 x 1915 x 110	600	1 pc(s).	<b>3301.370</b>
Side panel and 482.6 mm (19") level	84 x 1910 x 84	600	1 pc(s).	<b>3301.380</b>
Side panel and 482.6 mm (19") level	184 x 1910 x 84	800	1 pc(s).	<b>3301.390</b>

# Liquid Cooling Unit/Package

## Accessories

### Connection hose

#### for LCP Rack/Inline CW

Flexible connection hose at the bottom or top, may be cut to required length, including union nuts on both ends for connecting the LCP to existing pipe-work.

Length m	Water connections	Packs of	Model No.
1.8	1½"	2 pc(s).	<b>3311.040</b>



### Rear adaptor

#### for LCP Inline CW

May be positioned to the rear of the set forward LCP Inline CW to close the existing gap to the rear section.

Packs of	Model No.
1 pc(s).	<b>3311.080</b>



### Filter mat holder

#### for LCP Inline CW

The filter mat holder is comprised of a metal frame, into which the open-pore filter mat is inserted. The filter mat is fixed in the frame with additional metal brackets. The filter mat holder itself is secured in the perforated rear door of the LCP Inline CW using magnets.

#### Supply includes:

- Filter mat holder
- Filter mat
- Assembly parts

Filter class to DIN EN 779	Packs of	Model No.
G1	1 pc(s).	<b>3311.042</b>

#### Accessories:

- Filter mat, see page 527



### Filter mat

#### for LCP Inline CW

Matching, open-pore spare filter mat for the filter mat holder in the LCP Inline CW.

#### Colour:

- Dark grey

Filter class to DIN EN 779	Packs of	Model No.
G1	3 pc(s).	<b>3311.043</b>

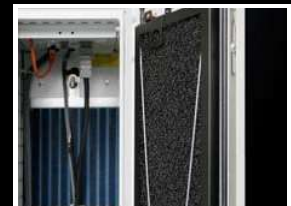

# Liquid Cooling Unit/Package

## Accessories



### Fan module

#### for LCP Rack/Inline CW

To increase the cooling output, individual fan modules may be retro-fitted into the LCPs. Additional integration can also achieve redundancy or reduce the electric power consumption of the LCP.

Packs of	Model No.
1 pc(s).	<b>3311.011</b>

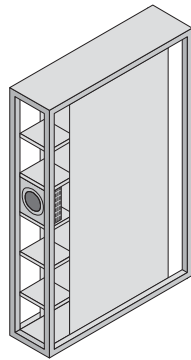

The LCP 3311.130/.230/.530 (max. 30 kW) is supplied with one fan module as standard.

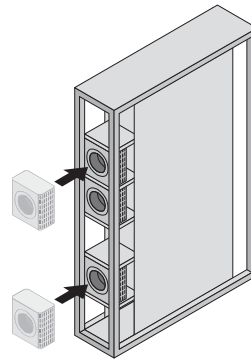

To achieve the max. cooling output of 30 kW, the customer/service should install two additional fan modules.

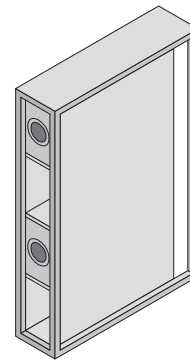

The LCP 3311.540 (max. 30 kW) is supplied with two fan modules as standard.

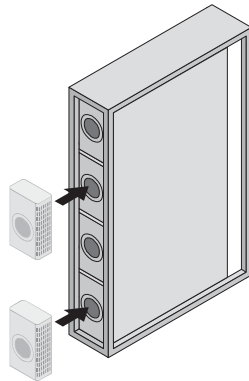

To achieve the max. cooling output of 30 kW, the customer/service should install two additional fan modules.

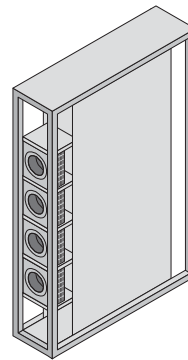

The LCP 3311.260/.560 (max. 55 kW) is supplied with four fan modules as standard.

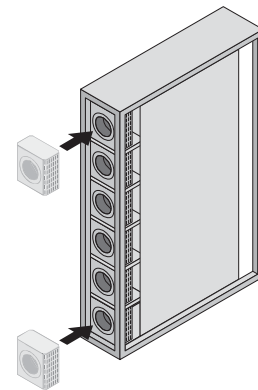

To achieve the max. cooling output of 55 kW, the customer/service should install two additional fan modules.

# Aisle containment



**Liquid Cooling Package** Page 523 **Network/server enclosures TS IT** Page 100

Slimline door element with viewing window and sliding door. Stable roof elements in a composite material with a high level of light permeability. Where required, safety glass may also be used. The aisle width is 1,200 mm.

**Applications:**

- Depending on the application, aisle containment may be used with CRAC systems or LCP Inline as hot or cold aisle containment.

**Benefits:**

- Increased energy efficiency and performance capability of climate control.
- Easily installed and retrofitted, as it is fully compatible with the TS IT enclosure system.
- An inexpensive way to boost the performance of your existing installation, lengthening the investment cycle until a replacement needs to be purchased.

**Functions:**

- Aisle containment is a combination of door and roof components which facilitate consistent separation of the hot and cold air in the data centre. Such separation is pivotal to saving energy and increasing the efficiency of the available climate control technology.

**Colour:**

- RAL 7035

Photo shows a configuration example with equipment not included in the scope of supply

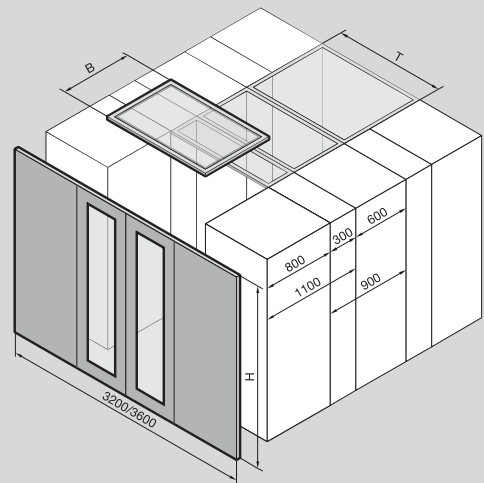

Design	Packs of	Door element	Door element	Roof element centre	Roof element centre	Roof element centre	Roof element centre	Roof element centre	Roof element start/end	Roof element start/end	Page
<b>Model No.</b>	1 pc(s).	<b>3311.161</b>	<b>3311.163</b>	<b>3311.170</b>	<b>3311.180</b>	<b>3311.190</b>	<b>3311.200</b>	<b>3311.210</b>	<b>3311.270</b>	<b>3311.280</b>	
For enclosure depth mm		1000	1200	-	-	-	-	-	-	-	
Width (B) mm		3200	3600	600	800	300	900	1100	600	800	
Height (H) mm		2000	2000	-	-	-	-	-	-	-	
Depth (T) mm		-	-	1200	1200	1200	1200	1200	1200	1200	
Weight as delivered kg		120.0	150.0	30.0	35.0	20.0	30.0	33.0	30.0	28.0	

# Roof-mounted cooling units



Accessories for climate control Page 454

### Applications:

- Cooling of IT equipment in IT enclosures sited as stand-alone units in secondary rooms

### Benefits:

- Even air distribution in front of the 482.6 mm (19") level

### Functions:

- The device supports front-to-back air routing typical of IT applications, and regulates the server inlet temperature to the set value
- The hot waste air from the IT equipment is drawn into the device at the rear of the IT enclosure, cooled, and the cooled air blown back in front of the 482.6 mm (19") level
- It is mounted on the roof of the IT enclosure, and cools the air volume inside the enclosure

### IT monitoring:

- Monitoring of incoming air temperature

### Temperature control:

- Control of the server inlet temperature

### Material:

- Sheet steel

### Colour:

- RAL 7035

### Protection category IP to IEC 60 529:

- External circuit IP 20
- Internal circuit IP 20

### Supply includes:

- Nano-coated condenser
- Integral electric condensate evaporation
- Fully wired ready for connection
- Drilling template
- Air baffle plate
- Assembly parts

### Note:

- A roof plate with cut-out to match the enclosure dimensions is required

## For cooling IT equipment

Model No.	Packs of	3301.800	Page
<b>Total cooling output L25 L35 W</b>		<b>3000</b>	
<b>Total cooling output L35 L45 W</b>		<b>3200</b>	
Width mm		597	
Height mm		417	
Depth mm		895	
Type of electrical connection		Plug-in terminal strip	
Rated operating voltage V, ~, Hz		230, 1~, 50	
Start-up current max. A		36	
Pre-fuse (T) A		16	
Rated current max. A		9.2	
Refrigerant g		R134a, 700	
Permissible operating pressure (p. max.) bar		25	
Duty cycle %		100	
Operating temperature range		+10°C...+45°C	
Setting range		+20°C...+22°C	
Weight as delivered kg		97.0	
<b>Accessories</b>			
Condensate hose	1 pc(s).	3301.612	464
Door-operated switch	1 pc(s).	4127.010	755
Air baffle plates for TS IT 482.6 mm (19") mounting angles		see page	812
Filter mats	3 pc(s).	3286.500	454

# Small cooling units

## Roof-mounted fans

### for TS, TS IT, for the office sector

This roof ventilation concept offers a wealth of performance, assembly and cost benefits associated with the use of integrated ventilation systems. This roof-mounted fan may be ordered with and without a roof plate. For the version with roof plate, the roof-mounted fan is pre-installed. Another outstanding feature is the enormous volumetric flow in proportion to exceptionally low noise levels, making it ideal for use in sensitive office areas.

#### Benefits:

- Easy assembly, the roof plate variant eliminates the need to create mounting cut-outs
- Fully wired ready for connection

#### Colour:

- RAL 7035

#### Supply includes:

- Roof-mounted fans
- Assembly parts

#### Note:

- Reduction in the specified air throughput to 800 m<sup>3</sup>/h at 40 Pa counterpressure using two vented base/plinth trim panels 8100.802 in the Flex-Block base/plinth system

Model No.	3164.230	3164.620
Packs of	1 pc(s).	1 pc(s).
Rated operating voltage V, ~, Hz	230, 1~, 50/60	230, 1~, 50/60
<b>Air throughput, unimpeded air flow m<sup>3</sup>/h</b>	<b>1500</b>	<b>1500</b>
Design	without roof plate	with roof plate
Rated current A	0.3 / 0.35	0.3 / 0.35
Power consumption W	68 / 81	68 / 81
Width mm	511	800
Height mm	227	240
Depth mm	511	800
Required mounting cut-out mm	410 x 410	-
Fan	Radial	Radial
Operating temperature range	+20°C...+55°C	+20°C...+55°C
Noise level dB(A)	40	40
Weight kg	19.5	30.0

#### ⊕ Accessories:

- Digital enclosure internal temperature display and thermostat integrated into a patch panel 1 U, see page 466
- Digital enclosure internal temperature display and thermostat, see page 466
- Thermostat, see page 467
- Thermostat with strain relief, see page 467
- Speed control, see page 470

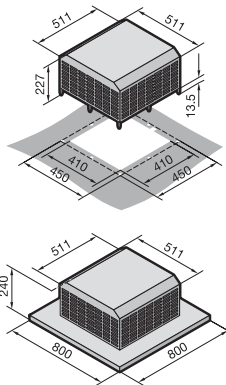

# Small cooling units

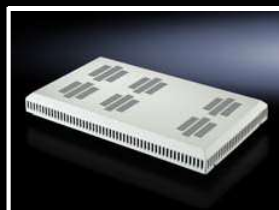

## Fan mounting plate

### for TS IT, TE

For active ventilation. The unit may optionally be extended with additional fans.

#### Applications:

- For use in the cut-out integrated into the roof plate

#### Colour:

- RAL 7035

#### Supply includes:

- 1 fan unit
- 2 fans
- 1 thermostat
- Connection cable, open-ended
- Assembly parts

#### Note:

- The noise level given refers to the first fan
- Connection via distributor box or country-specific connector

### + Accessories:

- Fan expansion kit, see page 533

To fit enclosure width/depth mm	W x H x D mm	Number of fans	Number of fans (max.)	Air through-put per fan m <sup>3</sup> /h	Output per fan W	Rated operating voltage V, ~, Hz	Operating temperature range	Noise level per fan dB(A)	Packs of	Model No.
800 x 600 600 x 1000 600 x 1200 600 x 600 600 x 800	200 x 59 x 550	2	3	160 / 180	15 / 14	230, 1~, 50/60	+5°C... +55°C	37	1 pc(s).	<b>5502.010</b>
800 x 800 800 x 1000 800 x 1200	340 x 54 x 550	2	6	160 / 180	15 / 14	230, 1~, 50/60	+5°C... +55°C	37	1 pc(s).	<b>5502.020</b>



# Small cooling units

## Fan mounting plate

For upgrading existing DK-TS applications. The plate is mounted at the front of the enclosure, whilst the rear section is left free for cable entry. A rubber cable clamp strip is supplied loose for optional sealing at the rear.

### Installation options:

- In a solid roof plate raised with 20 or 50 mm roof spacers
- In a roof plate for cable entry raised with 20 or 50 mm roof spacers
- In a vented roof plate for cable entry

### Colour:

- RAL 7035

### Supply includes:

- 2 fans
- Additional cut-outs to install further fans
- 1 thermostat
- Foam rubber cable clamp strip
- Thermostat and fan fully wired to connection cable (3.5 m)

### Note:

- Not suitable for crane transportation
- In combination with the swing frame, large, or roof plate for cable entry at the rear, the fan mounting plate should be selected as follows:  
Fan mounting plate = enclosure depth - 200 mm
- Not suitable in combination with 482.6 mm (19") mounting frame
- The air throughput can be increased with fan expansion kit 7980.000
- The noise level given refers to the first fan

### Assembly instruction:

- Rubber cable clamp strip 2573.000 is required for sealing the sides and for targeted air routing when bayed

### Accessories:

- Fan expansion kit, see page 533

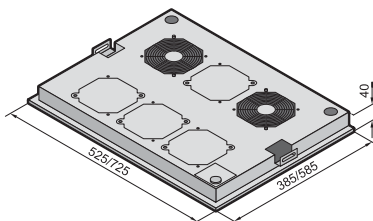

To fit enclosure width/depth mm	Number of fans	Number of fans (max.)	Air throughput per fan m³/h	Output per fan W	Rated operating voltage V, ~, Hz	Operating temperature range	Noise level per fan dB(A)	Packs of	Model No.
600 x 600	2	4	160 / 180	15 / 14	230, 1~, 50/60	+5°C...+55°C	37	1 pc(s).	<b>7966.035</b>
600 x 800 600 x 1000 600 x 1200	2	6	160 / 180	15 / 14	230, 1~, 50/60	+5°C...+55°C	37	1 pc(s).	<b>7968.035</b>
800 x 600	2	6	160 / 180	15 / 14	230, 1~, 50/60	+5°C...+55°C	37	1 pc(s).	<b>7986.035</b>
800 x 800 800 x 1000 800 x 1200	2	6	160 / 180	15 / 14	230, 1~, 50/60	+5°C...+55°C	37	1 pc(s).	<b>7988.035</b>

## Fan expansion kit

For use as a stand-alone fan, and for upgrading various fan units or to supplement the fan mounting plate.

### Supply includes:

- Fan
- Connection cable (0.61 m)
- Assembly parts

W x H x D mm	Air throughput (unimpeded air flow) m³/h	Rated operating voltage V, ~, Hz	Power consumption W	Operating temperature range	Noise level dB(A)	Packs of	Model No.
119 x 119 x 38	160 / 180	230, 1~, 50/60	15 / 14	-10°C...+55°C	37 / 37	1 pc(s).	<b>7980.000</b>
119 x 119 x 25	108 / 120	230, 1~, 50/60	14 / 12	-20°C...+70°C	34 / 34	1 pc(s).	<b>7980.100</b>
119 x 119 x 38	184	48 (DC)	7.7	-20°C...+70°C	43	1 pc(s).	<b>7980.148</b>



# Small cooling units



## Door-mounted fan

For upgrading existing DK-TS applications. Designed especially for installing in one-piece perforated sheet steel doors. The growing packaging density in server and network enclosures makes active, direct ventilation of the enclosure essential. The fan cross member, which is attached to the tubular door frame of the rear or front door, supports horizontal air routing via the servers to enable faster heat dissipation from active components.

### Benefits:

- By adding two fan expansion kits, the air throughput is increased to 1200 m<sup>3</sup>/h
- The direction of air flow is easily reversed by rotating the fan
- Several units may be positioned in a cascade arrangement
- Simple mounting on the tubular door frame
- Fully wired ready for connection

### Colour:

- RAL 7035

### Supply includes:

- 2 fans
- Connection cable (2.5 m)
- Assembly parts

### Note:

- Only for mounting on the tubular door frame!

Model No.	3165.630	3165.830
Packs of	1 pc(s).	1 pc(s).
Rated operating voltage V, ~, Hz	230, 1~, 50/60	230, 1~, 50/60
<b>Air throughput, unimpeded air flow m<sup>3</sup>/h</b>	<b>600</b>	<b>600</b>
Rated current A	0.38 / 0.36	0.38 / 0.36
Power consumption W	70 / 70	70 / 70
Width mm	493	693
Height mm	606	606
Depth mm	64.5	64.5
To fit width mm	600	800
Operating temperature range	+20°C...+55°C	+20°C...+55°C
Noise level dB(A)	55	55
Weight kg	9.3	12.7



### Accessories:

- Fan expansion kit, see page 534
- Digital enclosure internal temperature display and thermostat, see page 466
- Thermostat, see page 467
- Thermostat with strain relief, see page 467

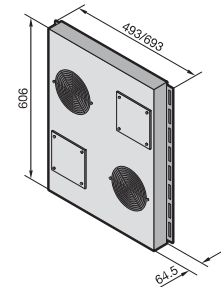

## Fan expansion kit

### for door-mounted fan

To increase the air throughput of the door-mounted fan.

To fit Model No.	Packs of	Model No.
3165.630/3165.830	1 pc(s).	<b>3165.230</b>

# Small cooling units

## Cover plates for fan panels

### for FlatBox

To cover unused fan panels when using fans in the FlatBox.

#### Material:

- Sheet steel

#### Surface finish:

- Powder-coated

#### Colour:

- RAL 7035

#### Supply includes:

- Assembly parts

Packs of	<b>Model No.</b>
6 pc(s).	<b>7507.760</b>



## Vent cover

The ideal addition for incorporating sealed racks into an existing central climate control system. The stepped connection is suitable for standard pipe diameters, thereby ensuring effective cooling thanks to targeted air exchange inside the rack.

#### Material:

- PET-G, transparent

#### Supply includes:

- Assembly parts

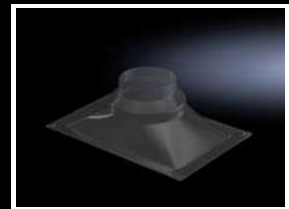

W x H x D mm	Required cut-out in the roof plate (WxD) mm	Diameter of hose connection mm	Weight kg	Packs of	<b>Model No.</b>
450 x 144 x 300	380 x 230	150/200	0.96	1 pc(s).	<b>7826.750</b>

# Precision climate control units for data centres



## The technology – Simply efficient

Precision climate control units from Rittal ensure optimum climatic conditions in data centres that are exposed to high thermal loads. By precisely regulating the temperature and humidity, these climate control units guarantee optimum ambient conditions for your valuable IT equipment. Waste heat is dissipated according to requirements. Redundant solutions offer a high degree of fail-safeness and energy-efficient use.

### CRAC DX precision climate control units for direct evaporation with external air-cooled condenser unit

- Upflow, downflow, displacement
- AC fan or optionally EC fan
- Available with electronic expansion valve, electric heater, steam humidifier, additional heat exchanger for cooling with cold water instead of direct evaporation or internal water-cooled condenser unit
- Complete set of optional accessories: Network protocol cards, filter, plenum space, base frame

### CRAC DX precision climate control units for direct evaporation with inverter-controlled compressor and external air-cooled condenser unit

- Upflow, downflow, displacement
- EC fan
- Available with electric heater, steam humidifier, additional heat exchanger for cooling with cold water instead of direct evaporation or internal water-cooled condenser unit
- Complete set of optional accessories: Network protocol cards, filter, plenum space, base frame

### CRAC CW precision climate control units for cold water operation

- Upflow, downflow, displacement
- Fans positioned in the device or in the raised floor (downflow only)
- EC fan
- Available with electric heater, steam humidifier
- Complete set of optional accessories: Network protocol cards, filter, plenum space, base frame



# Chillers for IT cooling



## Applications:

- Especially for cooling IT applications, such as LCP or air/water heat exchangers. Safety-relevant features such as redundant speed-controlled pumps, compressors or buffer stores are the distinguishing features of these atmospherically sealed systems

## Technical specifications:

- Compact design with control components in the front and air intake via both side panels, air outlet upwards
- Pressure-sealed system
- Digital thermostat for temperature control with setpoint and actual value display
- Controller with networking capability, compatible with the SNMP protocol
- Integral bypass

## Temperature control:

- Electronic control with digital display (factory setting +15°C)

## Protection category IP to IEC 60 529:

- IP 54

## Supply includes:

- Chiller wired ready for connection
- Multi-lingual documentation
- Functional diagram and wiring plans

## Optional:

- Free cooling may be integrated from 15 kW. Please follow the instructions
- Buffer store for separate siting
- Emergency cooling with mains water infeed
- Special voltages

## Note:

- Technical deviations in terms of cooling output, dimensions or weight are possible for unit types with free cooling
- The performance data varies according to the option package chosen, and should be taken from the IT chiller configurator. We reserve the right to make technical modifications
- Pump and tank are available as options with IT chillers. If these configuration options are required, their technical data applies

## Total cooling output 15 – 67 kW

Model No.	Packs of	3232.701	3232.711	3232.721	3232.731	3232.741	Page
<b>Total cooling output kW</b>		<b>15</b>	<b>24</b>	<b>36</b>	<b>48</b>	<b>67</b>	
Width mm		810	810	810	1000	1100	
Height mm		1542	1542	1542	1780	1606	
Depth mm		1800	1800	1800	2300	3240	
Rated operating voltage V, -, Hz		400, 3~, 50	400, 3~, 50	400, 3~, 50	400, 3~, 50	400, 3~, 50	
Air throughput at max. cooling output m³/h		10880	10880	14000	18000	22000	
Power consumption kW		6.9	9.7	14.6	21	21	
Rated current max. A		23	25	37	46.5	52.2	
Refrigerant		R407c	R407c	R407c	R407c	R410a	
Permissible operating pressure (p. max.) bar		28	28	28	28	45	
Operating temperature range		-20°C...+43°C	-20°C...+43°C	-20°C...+43°C	-20°C...+43°C	-20°C...+43°C	
Temperature of liquid		+5°C...+15°C	+5°C...+15°C	+5°C...+15°C	+5°C...+15°C	+5°C...+15°C	
Pump capacity l/min		60	60	120	120	240	
Pump pressure bar		2.5	2.5	2.5	2.5	2.5	
Number of cooling circuits		1	1	1	1	2	
Steel tank, with 10 mm condensate insulation		■	■	■	■	■	
Tank capacity l		48	48	48	100	200	
Water connection		G 1½" internal thread	G 1½" internal thread	G 1½" internal thread	G 1½" internal thread	G 2½" internal thread	
Weight as delivered kg		400.0	415.0	505.0	710.0	896.0	
Operating weight kg		448.0	463.0	553.0	810.0	1096.0	
Colour		RAL 7035	RAL 7035	RAL 7035	RAL 7035	RAL 9002	

# Chillers for IT cooling

## Total cooling output 77 – 124 kW

Model No.	Packs of	3232.751	3232.761	3232.771	3232.781	3232.791	Page
<b>Total cooling output kW</b>		<b>77</b>	<b>88</b>	<b>99</b>	<b>117</b>	<b>124</b>	
Width mm		1100	1100	1100	1100	1100	
Height mm		1606	1606	1606	1875	1875	
Depth mm		3240	3240	3240	3240	3240	
Rated operating voltage V, ~, Hz		400, 3~, 50	400, 3~, 50	400, 3~, 50	400, 3~, 50	400, 3~, 50	
Air throughput at max. cooling output m <sup>3</sup> /h		22000	27000	27000	34100	34100	
Power consumption kW		24	26	29	36	41	
Rated current max. A		59.2	64.2	69.2	84.1	89.1	
Refrigerant		R410a	R410a	R410a	R410a	R410a	
Permissible operating pressure (p. max.) bar		45	45	45	45	45	
Operating temperature range		-20°C...+43°C	-20°C...+43°C	-20°C...+43°C	-20°C...+43°C	-20°C...+43°C	
Temperature of liquid		+5°C...+15°C	+5°C...+15°C	+5°C...+15°C	+5°C...+15°C	+5°C...+15°C	
Pump capacity l/min		240	240	240	470	470	
Pump pressure bar		2.5	2.5	2.5	2.5	2.5	
Number of cooling circuits		2	2	2	2	2	
Steel tank, with 10 mm condensate insulation		■	■	■	■	■	
Tank capacity l		200	200	200	300	300	
Water connection		G 2½" internal thread	G 2½" internal thread	G 2½" internal thread	G 2½" internal thread	G 2½" internal thread	
Weight as delivered kg		896.0	906.0	912.0	1000.0	1000.0	
Operating weight kg		1096.0	1106.0	1112.0	1300.0	1300.0	
Colour		RAL 9002	RAL 9002	RAL 9002	RAL 9005	RAL 9005	

## Total cooling output 155 – 261 kW

Model No.	Packs of	3232.801	3232.811	3232.821	3232.891	3232.831	Page
<b>Total cooling output kW</b>		<b>155</b>	<b>172</b>	<b>196</b>	<b>235</b>	<b>261</b>	
Width mm		1100	1100	1100	1500	2200	
Height mm		1875	1875	1875	1975	2450	
Depth mm		3240	3240	4240	4350	3400	
Rated operating voltage V, ~, Hz		400, 3~, 50	400, 3~, 50	400, 3~, 50	400, 3~, 50	400, 3~, 50	
Air throughput at max. cooling output m <sup>3</sup> /h		32600	32600	50000	49000	72800	
Power consumption kW		47	52	60	70	80	
Rated current max. A		108	120	127	149	181	
Refrigerant		R410a	R410a	R410a	R410a	R410a	
Permissible operating pressure (p. max.) bar		45	45	45	45	45	
Operating temperature range		-20°C...+43°C	-20°C...+43°C	-20°C...+43°C	-20°C...+43°C	-20°C...+43°C	
Temperature of liquid		+5°C...+15°C	+5°C...+15°C	+5°C...+15°C	+5°C...+15°C	+5°C...+15°C	
Pump capacity l/min		500	500	500	500	810	
Pump pressure bar		2.5	2.5	2.5	2.5	2.5	
Number of cooling circuits		2	2	2	2	2	
Steel tank, with 10 mm condensate insulation		■	■	■	■	■	
Tank capacity l		300	300	300	300	700	
Water connection		G 2½" internal thread	G 2½" internal thread	G 2½" internal thread	G 2½" internal thread	G 3" internal thread	
Weight as delivered kg		1000.0	1000.0	1000.0	1900.0	2500.0	
Operating weight kg		1300.0	1300.0	1300.0	2200.0	3200.0	
Colour		RAL 9002	RAL 9002	RAL 9002	RAL 9002	RAL 9002	



# Chillers for IT cooling

Total cooling output 291 – 481 kW

Model No.	Packs of	3232.841	3232.851	3232.861	3232.871	3232.881	Page
<b>Total cooling output kW</b>		<b>291</b>	<b>326</b>	<b>387</b>	<b>430</b>	<b>481</b>	
Width mm		2200	2200	2200	2200	2200	
Height mm		2450	2450	2450	2450	2450	
Depth mm		3400	3400	4250	4250	4250	
Rated operating voltage V, ~, Hz		400, 3~, 50	400, 3~, 50	400, 3~, 50	400, 3~, 50	400, 3~, 50	
Air throughput at max. cooling output m³/h		71500	70200	106200	104100	102000	
Power consumption kW		93	106	121	141	159	
Rated current max. A		203	225	293	307	336	
Refrigerant		R410a	R410a	R410a	R410a	R410a	
Permissible operating pressure (p. max.) bar		45	45	45	45	45	
Operating temperature range		-20°C...+43°C	-20°C...+43°C	-20°C...+43°C	-20°C...+43°C	-20°C...+43°C	
Temperature of liquid		+5°C...+15°C	+5°C...+15°C	+5°C...+15°C	+5°C...+15°C	+5°C...+15°C	
Pump capacity l/min		810	810	1200	1200	1200	
Pump pressure bar		2.5	2.5	2.5	2.5	2.5	
Number of cooling circuits		2	2	2	2	2	
Steel tank, with 10 mm condensate insulation		■	■	■	■	■	
Tank capacity l		700	700	700	700	700	
Water connection		G 3" internal thread	G 3" internal thread	G 4" internal thread	G 4" internal thread	G 4" internal thread	
Weight as delivered kg		2700.0	2800.0	3100.0	3000.0	3600.0	
Operating weight kg		3400.0	3500.0	3800.0	3700.0	4300.0	
Colour		RAL 9002	RAL 9002	RAL 9002	RAL 9002	RAL 9002	





# Rittal – The System.

Faster – better – everywhere.

## Chiller Configurator – Simple calculation of output

The screenshot shows the Rittal TopTherm Chiller Configurator interface. At the top left, it says "Rittal – The System. Faster – better – everywhere." with a "Contact" and "Print / Terms and Conditions" link. The main heading is "Welcome to the TopTherm Chiller Configurator". Below this, a paragraph states: "This Configurator is a cost-effective way of designing your required machine and process cooling. Cooling output, volumetric flow and coolant temperatures are precisely tailored to the required level of your application. The choice is yours!". To the right is an image of a white chiller unit. The interface features two calculation paths: 1) "Would you like to calculate the heat loss?" with input fields for "Medium outlet temperature in °C", "Medium inlet temperature in °C", and "Volumetric flow in l/min", and a "Calculate heat loss" button. 2) "Do you already know the heat loss?" with a "Heat loss in kW (T1-T2)" input field and a "To design selected" button. At the bottom, a navigation bar includes "ENCLOSURES", "POWER DISTRIBUTION", "CLIMATE CONTROL", "IT INFRASTRUCTURE", and "SOFTWARE & SERVICES". The Rittal logo and "FRIEDHELM LOH GROUP" are also visible.

ENCLOSURES

POWER DISTRIBUTION

CLIMATE CONTROL

IT INFRASTRUCTURE

SOFTWARE & SERVICES



FRIEDHELM LOH GROUP

# Rittal – The System.

Faster – better – everywhere.



# IT monitoring

## CMC III – Monitoring system

CMC III system representation .....	544
CMC III Processing Unit / Compact system overview .....	546
CMC III Processing Unit / Compact .....	548

## CMC III sensors/accessories

Control units for CMC III Processing Unit .....	549
Sensors for direct connection .....	550
Interface for CMC-TC sensors .....	551
Products with CAN bus interface for direct connection .....	552
Access system .....	553

## CMC III door control system

Door control system DCS .....	554
Door control module .....	555
Door kit .....	555
Door kit extension .....	556
Door comfort handle .....	556
Door switch .....	556

## CMC III accessories

Power supply unit .....	557
Programming cable .....	557
CAN bus connection cable .....	557
Connection cable/extension .....	558
Extension cable RJ 12 .....	558
Mounting unit, 1 U .....	558
Cable clamp strap .....	558
Mounting unit .....	559
CMC III GSM unit .....	559
Interference suppressor for fans .....	559

## Dynamic Rack Control

RFID aerial .....	561
RFID tags .....	561
RFID controller .....	561
CMC III CAN bus DRC .....	561

## Management software

RiZone .....	562
Server shutdown software .....	562

## Monitor/keyboard unit

Monitor/keyboard unit, 1 U .....	563
KVM switch .....	563

## Your benefits

- A better overview of your IT infrastructure
- Enhanced security
- Automated processes
- Exceptional cost efficiency
- Huge energy savings
- Simple project management
- Fast installation
- Flexible, individual solutions using standard products from Rittal
- High standard of quality with coordinated standard products

## Sample applications

- 1 CMC III, see page 547
- 2 Liquid Cooling Package LCP, see page 522
- 3 Monitor/keyboard unit, see page 563
- 4 Electric comfort handle TS 8, see page 553

# CMC III – Monitoring system

Computer Multi Control (CMC) is an alarm system for network and server enclosures, standard enclosures, containers and rooms.

- It monitors temperatures, humidity, access, fumes, energy and many other physical ambient parameters.
- The system is modular and can be flexibly adapted to meet specific monitoring requirements.
- User benefits plus exceptional savings are achieved thanks to monitoring via the network and the automation of security processes.

More information can be found on the Rittal website.

**1 CMC III Processing Unit**

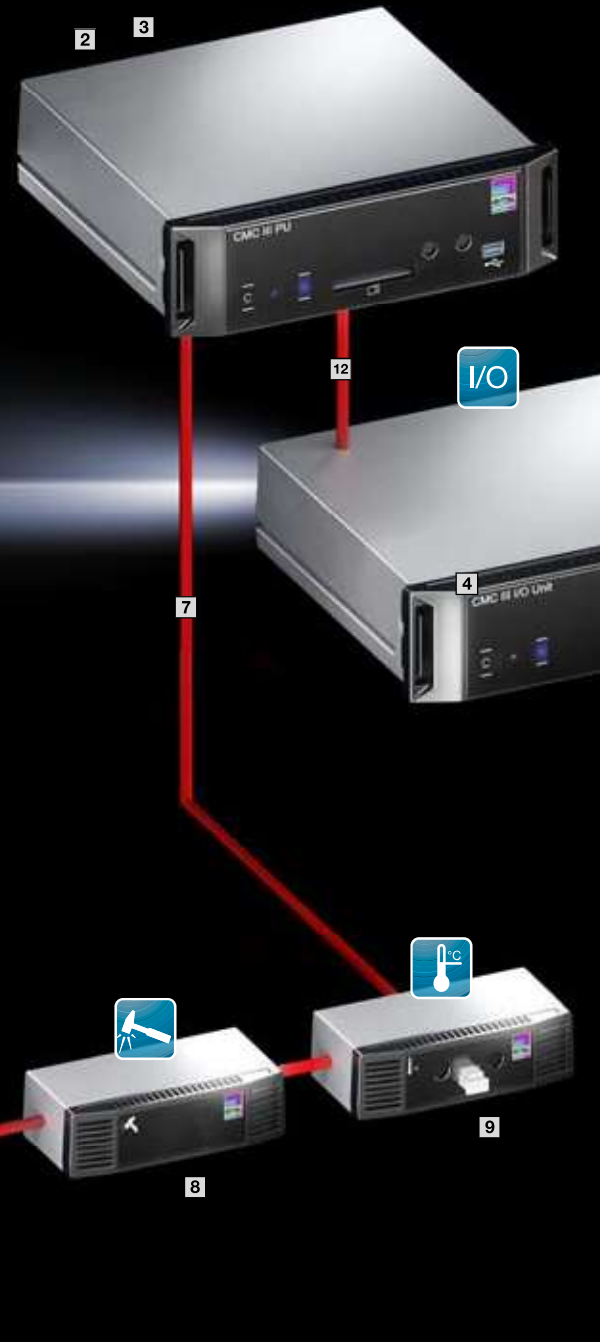

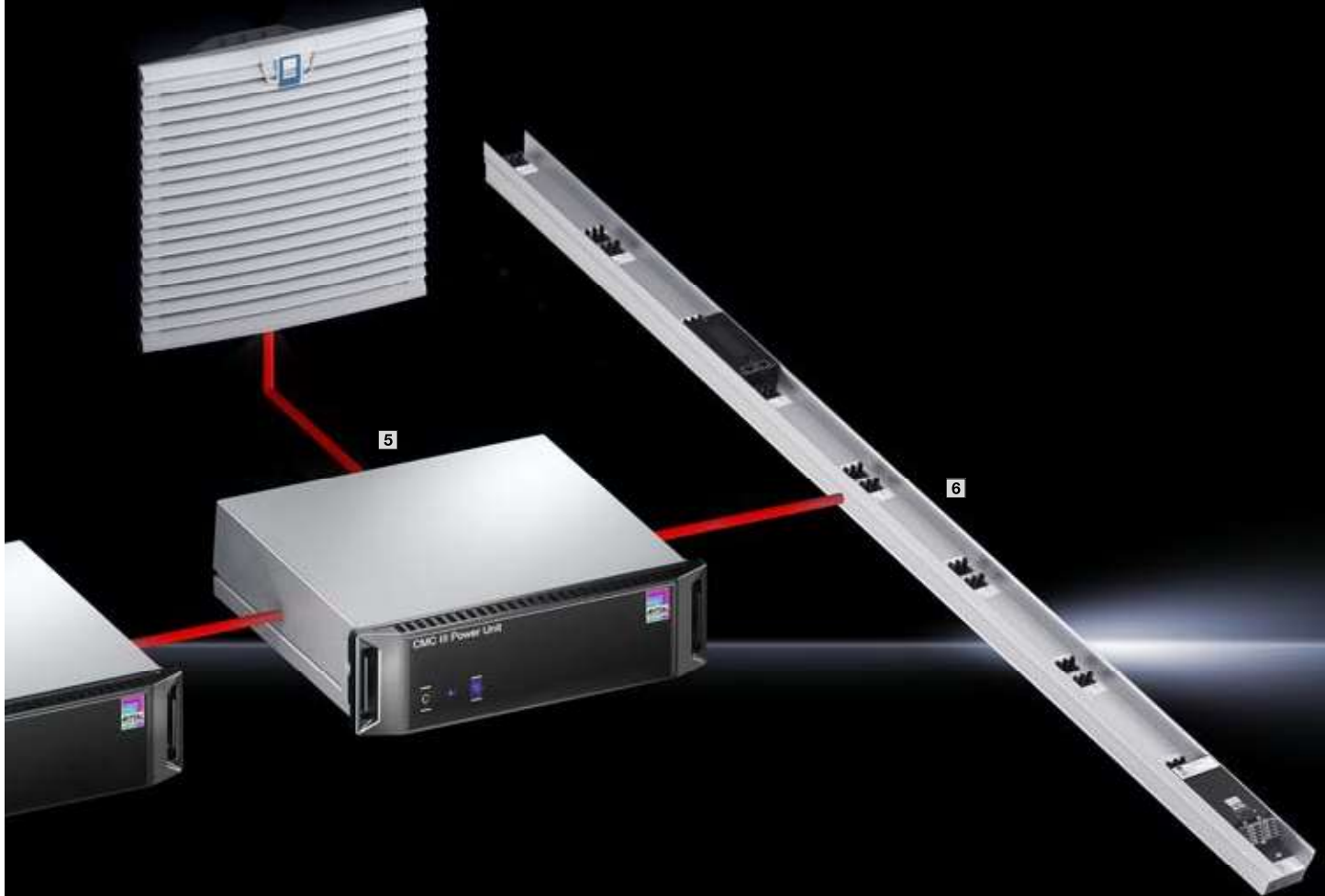

- 1 CMC III Processing Unit, see page
- 2 Power supply
- 3 Redundant power supply
- 4 CMC III I/O unit
- 5 CMC III power unit
- 6 CMC III PSM measuring bar for direct connection
- 7 Up to 16 CAN bus systems may be connected
- 8 CMC III vandalism sensor
- 9 CMC III temperature sensor
- 10 CMC III smoke alarm
- 11 CMC III CAN bus access
- 12 Up to 16 CAN bus systems may be connected

# CMC III Processing Unit Compact

## System overview



Up to 4 CAN bus components are supported<sup>1)</sup>

**CMC III sensors**  
for direct connection

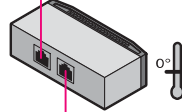

**CMC III CAN bus sensor**  
as adaptor for CMC II sensors

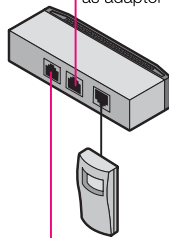

**CMC III CAN bus access**  
with integral infrared access sensor

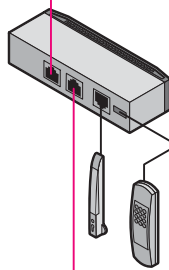

**PSM measurement module with CAN bus**

**CAN bus 1**

**Mini USB:**  
Programming cable 7030.080 is required for programming

**Integral infrared access sensor**

**CMC III Processing Unit Compact**

**Voltage supply 24 V (DC) and redundant voltage supply 24 V (DC)**

**Alarm relay output:**  
Changeover contact for safety extra-low voltage

**Ethernet RJ 45 with PoE**  
Ethernet interface to IEEE 802.3 via 10/100 BaseT full duplex 10/100 Mbit/s

**RJ 12/RS 232 accessory module:**  
GSM unit

**External temperature sensor**  
(included in scope of supply for PU Compact)

**Two integral digital inputs**

**Note:**  
Server shutdown software for CMC III is required to shut down the server

<sup>1)</sup> Depending on power supply/ connection combinations, see page 549 – 553

# CMC III Processing Unit

## System overview

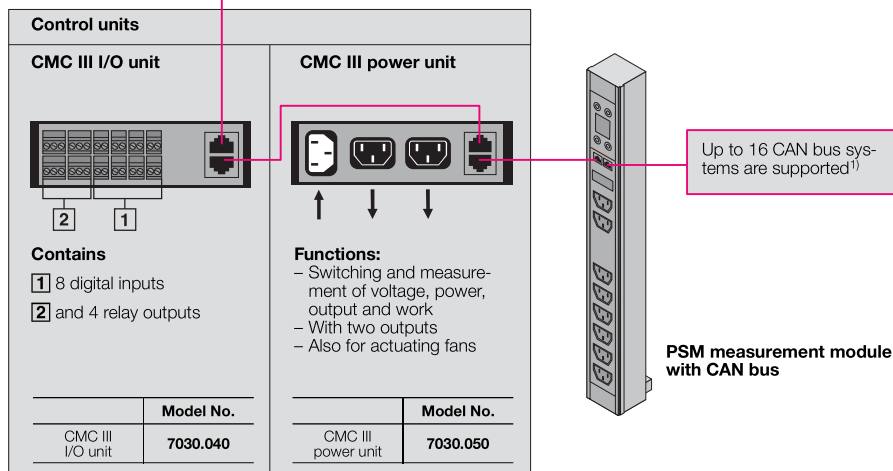
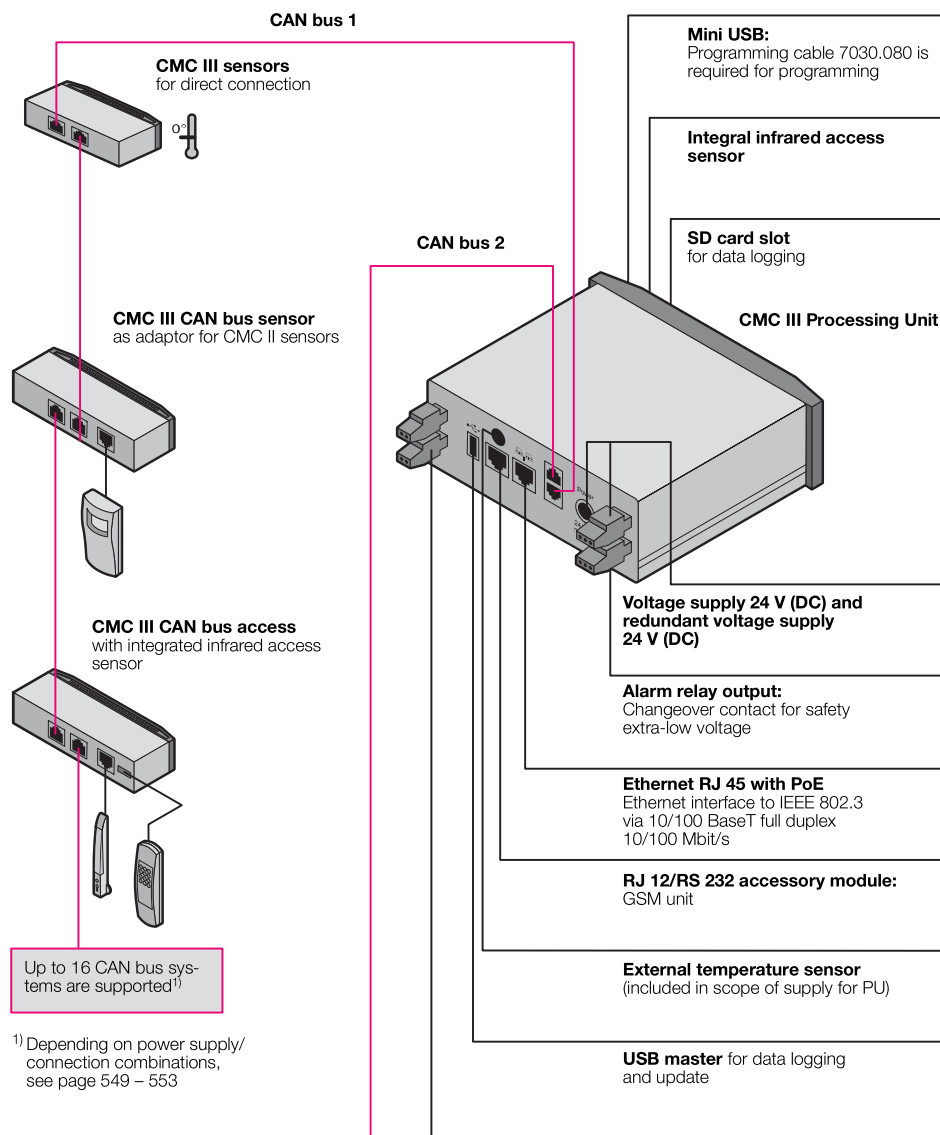

# CMC III Processing Unit / Compact



**System overview** Page 546/547 **Basic modules and connection accessories** from page 549

- Redundant voltage supply, plus Power over Ethernet (PoE)
- Simple wiring with CAN bus connection system (RJ 45)
- Connection to control room systems via OPC-UA

**Material:**  
– Plastic

**Surface finish:**  
– Front: Smooth  
– Enclosure: Textured

**Colour:**  
– Front: RAL 9005  
– Enclosure: RAL 7035

**Protection category IP to IEC 60 529:**  
– IP 30

**Supply includes:**  
– Basic system  
– Quick-start instructions  
– 4 mounting feet

**Note:**  
– Unencrypted protocols may be deactivated for enhanced network security

**Approvals:**  
– cULus

Photo shows a configuration example with equipment not included in the scope of supply

	<b>CMC III Processing Unit</b>		<b>CMC III Processing Unit Compact</b>	
W x H x D mm	138 x 40 (1 U) x 120 + 12 (front assembly)		138 x 40 (1 U) x 120 + 12 (front assembly)	
Operating temperature range	0°C...+45°C		0°C...+45°C	
Operating humidity range	5 – 95% relative humidity, non-condensing		5 – 95% relative humidity, non-condensing	
Sensors/CAN bus connection units	max. 32		max. 4	
Max. overall cable length for CAN bus	2 x 50 m		1 x 50 m	
<b>Model No.</b>	<b>7030.000</b>		<b>7030.010</b>	
	Packs of 1			
<b>Interfaces</b>	Network interface (RJ 45)	Ethernet to IEEE 802.3 via 10/100BaseT with PoE	Ethernet to IEEE 802.3 via 10/100BaseT with PoE	
	Front USB interface	Mini USB for system setting	Mini USB for system setting	
	Front USB interface	for USB stick for data recording up to 32 GB	–	
	Front SD-HC slot	1 x up to 32 GB for data recording	–	
	Rear serial RS232 (RJ 12)	1 x for connecting GSM unit	1 x for connecting GSM unit	
	CAN bus (RJ 45)	2 x for max. 16 sensors each = 32 sensors in total (quantity restriction, see page 549 – 553)	1 x for max. 4 sensors (quantity restriction, see page 549 – 553)	
<b>Inputs and outputs</b>	Digital inputs (terminal)	2	2	
	Relay output (terminal)	Changeover contact max. 24 V (DC), 1 A	Changeover contact max. 24 V (DC), 1 A	
	Switch/concealed reset button	1 x acknowledgement button/1 x service button	1 x acknowledgement button/1 x service button	
<b>Operation/signals</b>	Piezo signal generator	1	1	
	LED display	1 x multi-colour OK/warning/alarm	1 x multi-colour OK/warning/alarm	
	Rear LED	1 x for the network status	1 x for the network status	
<b>Protocols</b>	Ethernet	TCP/IPv4, TCP/IPv6, SNMPv1, SNMPv2c, SNMPv3, Telnet, SSH, (S)FTP, HTTP(S), NTP, DHCP, DNS, SMTP(S), Syslog	TCP/IPv4, TCP/IPv6, SNMPv1, SNMPv2c, SNMPv3, Telnet, SSH, (S)FTP, HTTP(S), NTP, DHCP, DNS, SMTP(S), Syslog	
<b>Redundant power supply</b>	Input 24 V DC (jack)	1 x for connecting CMC III power pack	1 x for connecting CMC III power pack	
	Input 24 V DC (terminals)	1 x for direct connection or for connecting CMC III power pack	1 x for direct connection or for connecting CMC III power pack	
	Power over Ethernet PoE	1 x 15.4 W	1 x 15.4 W	
<b>Functions</b>	Time function	Real-time clock, energy-buffered (24 h) without battery/accumulator, with NTP	Real-time clock, energy-buffered (24 h) without battery/accumulator, with NTP	
	User administration	Local, LDAP(S), Radius	Local, LDAP(S), Radius	
	User interface	Integral Web server with flexible dashboard and mobile view	Integral Web server with flexible dashboard and mobile view	
	Control room connection	Integral OPC-UA server, Modbus/TCP	Integral OPC-UA server, Modbus/TCP	
	Video monitoring	Incorporation of 1 x network camera	–	
<b>Integral sensors</b>	Temperature sensor	NTC sensor with cable, supplied loose	NTC sensor with cable, supplied loose	
	Access sensor	Infrared technology in the enclosure front	Infrared technology in the enclosure front	





### Control units for CMC III Processing Unit

**Dimensions:**  
 – W x H x D:  
 138 x 40 x 120 + 12 mm front frame

**Material:**  
 – Plastic

**Surface finish:**  
 – Front: Smooth  
 – Enclosure: Textured

**Colour:**  
 – Front: RAL 9005  
 – Enclosure: RAL 7035

**Protection category IP to IEC 60 529:**  
 – IP 30

**Supply includes:**  
 – Basic system  
 – Quick-start instructions  
 – 4 mounting feet



**Also required:**

– CAN bus connection cable 7030.090/.095, see page 557  
 – Mounting unit, 1 U, 7030.070, see page 558

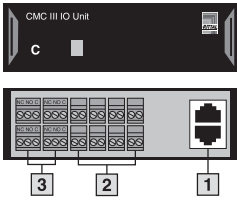
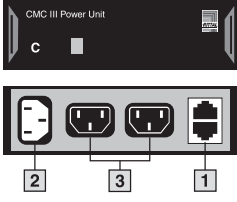
	1	2	3	Model No.	PU Compact	PU
	Connection RJ 45 2 x CAN bus	Inputs	Outputs	Packs of 1	Maximum quantity	
 <p><b>CMC III I/O unit</b>                      The relays can be linked to measured values in the software so that they are actuated under certain circumstances. This system can be used to monitor devices and forward messages.                      Cannot be operated with the Processing Unit Compact.                      – Inputs for potential-free signals                      – Relay output (changeover contact) can handle loads of up to max. 24 V (DC)/1 A</p>	■	8 x digital	4 x relays	<b>7030.040</b>	–	16
 <p><b>CMC III Power Unit</b>                      The input is switched to the outputs via two relays. In this way, the outputs can be linked to measured values and therefore can be switched automatically. Examples of potential applications include fan regulation. Manual switching via the CMC III operating interface is likewise supported. Each output is monitored individually, and various values are measured.                      Cannot be operated with the Processing Unit Compact.                      – Switches 2 outputs                      – Measures voltage, current, power, work                      – Application: Controlling and switching fans, heaters, equipment</p>	■	1 x C14 110 – 230 V 50/60 Hz	2 x C13 Aggregate current max. 10 A	<b>7030.050</b>	–	16



# CMC III

## Accessories



### CMC III sensors for direct connection

CMC III sensors are used for monitoring the physical environment and can be connected directly to the PU via a CAN bus connection cable RJ 45. The sensors may also be linked together to form a bus.

- Dimensions:**
- 7030.110/.111/.120/.130  
W x H x D: 80 x 28 x 40 mm
  - 7030.140/.150/.190/.430/.440  
W x H x D: 110 x 30 x 40 mm
  - 7030.400  
Ø x H: 100 x 60 mm

- Material:**
- Plastic

- Surface finish:**
- Front: Smooth
  - Enclosure: Textured

- Colour:**
- Front: RAL 9005
  - Enclosure: RAL 7035
  - Smoke detector: White











- Protection category IP to IEC 60 529:**
- IP 30

- Supply includes:**
- Sensor
  - Mounting bracket
  - Assembly parts
  - Instructions

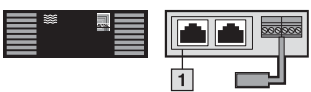

**Also required:**

- CAN bus connection cable 7030.090/.095, see page 557

	[1] Connection RJ 45 2 x CAN bus	[2] Inputs	Model No.	PU Compact	PU
			Packs of 1	Maximum quantity	
	■	–	<b>7030.110</b>	4	32
	■	–	<b>7030.111</b>	4	32
	■	–	<b>7030.120</b>	4	32
	■	–	<b>7030.130</b>	4	32
	■	–	<b>7030.140</b>	4	10 <sup>1)</sup>
	■	–	<b>7030.150</b>	4	32
	■	2 x digital may be switched over to pulse input S <sub>0</sub> or a Wiegand interface  1 x analog 4 – 20 mA	<b>7030.190</b>	4	32
	■	–	<b>7030.400</b>	4	32
	■	–	<b>7030.430</b>	4	32
	■	–	<b>7030.440</b>	4	32

<sup>1)</sup> Max. 5 pieces for power supply with PoE



### Interface for CMC-TC sensors

The CMC III CAN bus sensor supports the connection of selected sensors from the CMC-TC system to the new CMC III, allowing old applications to be upgraded with the CMC III Processing Unit / Compact. As well as the two CAN bus connections, the unit also has another connection for one of the CMC-TC sensors. In this way, the unit functions as an interface between the CMC-TC sensor and the new processing unit, and adapts the sensor data to the CAN bus protocol.

#### Dimensions:

- W x H x D:  
110 x 30 x 40 mm

#### Material:

- Plastic

#### Surface finish:

- Front: Smooth
- Enclosure: Textured

#### Colour:

- Front: RAL 9005
- Enclosure: RAL 7035

#### Protection category IP to IEC 60 529:

- IP 30

#### Supply includes:

- Sensor
- Mounting bracket
- Assembly parts
- Instructions

#### The following CMC-TC access sensors may be connected to the CMC III CAN bus sensor:

- 1 x temperature sensor
- 1 x analog input 4 – 20 mA
- 5 x access sensors in series
- 1 x airflow sensor
- 1 x smoke detector
- 1 x motion detector
- 1 x digital input
- 1 x digital relay output
- 1 x voltage monitor
- 1 x 48 V voltage sensor
- 1 x leak sensor
- 1 x leak sensor, 15 m sensors
- 1 x door control unit (two connections)
- 1 x DET-AC Plus extinguisher system (three connections)
- 1 x DET-AC Plus early fire detection system (three connections)





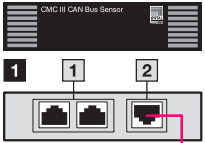
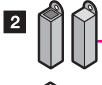
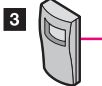

#### Also required:

- CAN bus connection cable 7030.090/.095, see page 557

	[1]	[2]	[3]	Model No.	PU Compact	PU
	Connection RJ 45 2 x CAN bus	Input RJ 12	Output RJ 12	Packs of	Maximum quantity	
 <p><b>1 CMC III CAN bus sensor</b> For connecting one CMC-TC sensor</p>	■	1 x	-	<b>7030.100</b>	4	32
				1 pc(s).		
<b>Connectable sensors (max. 1 sensor per CAN bus sensor)</b>						
 <p><b>2 CMC-TC access sensor</b> - Sensor: Reed contact/magnet - Max. 5 reed contacts in series - 2 m cable included with the supply</p>	-	-	1 x	<b>7320.530</b>	-	-
				2 pc(s).		
 <p><b>3 CMC-TC motion detector</b> - Sensor: Infrared - 2 m cable included with the supply</p>	-	-	1 x	<b>7320.570</b>	-	-
				1 pc(s).		

## Accessories

### Products with CAN bus interface for direct connection

	Model No.	PU Compact	PU	Page	
		Maximum quantity			
	PSM measurement bars 16 A, with 2 infeeds	7859.050	4	8	489
	PSM measurement bars 32 A, with 1 infeed	7859.053	4	8	489
	PSM measurement module with CAN bus, 8 x C13	7859.410	4	16	493
	PSM measurement module with CAN bus, 2 x C13, 4 x C19	7859.420	4	16	493
	PSM measurement module with CAN bus, 2 x C13, 4 x earthing-pin	7859.430	4	16	493
	PSM MID measuring module 16 A, with 2 infeeds	7859.312	4	8	496
	PSM MID measuring module 32 A, with 2 infeeds	7859.332	4	8	496
	Slave PDU international, managed, 16 A, 12 x C13	7955.901	3	6	503
	Slave PDU international, managed, 16 A, 24 x C13, 4 x C19	7955.910	3	6	503
	Slave PDU international, managed, 32 A, 24 x C13, 4 x C19	7955.911	3	6	503
	Slave PDU international, managed, 16 A, 18 x C13, 3 x C19	7955.931	3	6	503
	Slave PDU international, managed, 16 A, 24 x C13, 6 x C19	7955.932	3	6	503
	Slave PDU international, managed, 32 A, 24 x C13, 6 x C19	7955.933	3	6	503
	Slave PDU UK, managed, 13 A, 16 x UK	7955.940	3	6	504
	Slave PDU UK, managed, 16 A, 16 x UK, 4 x C19	7955.941	3	6	504
	Slave PDU UK, managed, 32 A, 16 x UK, 4 x C19	7955.942	3	6	504
	DET-AC III Master	7338.121	4	16	573
	DET-AC III Slave	7338.321	4	16	575
	EFD III	7338.221	4	16	574
	NH measurement module for NH fuse-switch disconnectors, size 00	9343.070	4	8	299
	NH measurement module for NH fuse-switch disconnectors, size 1	9343.170	4	8	299
	NH measurement module for NH fuse-switch disconnectors, size 2	9343.270	4	8	299
	NH measurement module for NH fuse-switch disconnectors, size 3	9343.370	4	8	299

#### Accessories:

- CAN bus connection cable 7030.090/.095, see page 557



### Access System

CMC III unit for controlling and monitoring access to enclosures. One handle and one reader unit may be connected to one CMC III CAN bus access. The handles can be linked to various numerical codes or RFID card numbers via the CMC III Processing Unit/ Compact website, which means that all the handles connected to a CMC III Processing Unit/Compact can be controlled with just one reader unit. The integral infrared sensor also ensures that the status of the controlled door (open/closed) is monitored.

#### Dimensions:

- W x H x D: 110 x 30 x 40 mm

#### Sample applications:

- Record of every access and each time the door is opened, with user information and time stamp
- One central reader unit per CMC III system is supported
- Fixed allocation between handles and reader units
- 4-eyes principle
- Central administration of access rights across systems and locations with RiZone

#### Material:

- Plastic

#### Surface finish:

- Front: Smooth
- Enclosure: Textured

#### Colour:

- Front: RAL 9005
- Enclosure: RAL 7035

#### Protection category IP to IEC 60 529:

- IP 30

#### Supply includes:

- CAN bus access
- Mounting bracket
- Assembly parts
- Instructions



#### Also required:

- CAN bus connection cable 7030.090/.095, see page 557

	Connection	Inputs		Outputs		Model No.	PU Compact	PU
	[1]	[2]	[3]	[4]	[5]			
	RJ 45 2 x CAN bus	RJ 12	Flat-pin connector	RJ 12	Flat-pin connector	Packs of 1	Maximum quantity	
<p><b>1 CMC III CAN bus access</b></p> <ul style="list-style-type: none"> <li>- For connecting one handle and one reader unit to monitor a door</li> <li>- Integral IR access sensor</li> </ul>	■	1 x	1 x	-	-	<b>7030.200</b>	2	16 <sup>1)</sup>
<b>Connectable handles and reader units (max. 1 handle and max. 1 reader unit per CMC III CAN bus access)</b>								
<p><b>2 Handles</b></p> <ul style="list-style-type: none"> <li>- <b>TS 8 handle with master key function</b> <ul style="list-style-type: none"> <li>- Handle monitoring</li> <li>- Rated voltage: 24 V (DC)</li> <li>- Connection cable: 0.5 m (fixed), 2.5 m (supplied loose)</li> </ul> </li> <li>- <b>Ergoform-S handle (electromagnetic, for TE 8000)</b> <ul style="list-style-type: none"> <li>- Handle monitoring</li> <li>- Rated voltage: 24 V (DC)</li> <li>- Connection cable: 3 m (fixed)</li> </ul> </li> </ul>	-	-	-	1 x	-	<b>7320.721</b>	-	-
	-	-	-	1 x	-	<b>7320.700</b>	-	-
<p><b>3 CMC III reader units</b></p> <ul style="list-style-type: none"> <li>- <b>Coded lock</b> <ul style="list-style-type: none"> <li>- Coded lock with up to 8 digits, freely selectable</li> <li>- 3 m cable included with the supply</li> </ul> </li> <li>- <b>Transponder reader</b> <ul style="list-style-type: none"> <li>- By contactlessly holding a transponder card in front of it, authorisation (UID of the card) is checked in the CMC III processing unit/compact, and the corresponding door(s) is/are released</li> <li>- Technology: Transponder 13.56 MHz</li> <li>- Tags: ISO 14443A, ISO 14443B, ISO 15693, ISO 18000-3</li> <li>- 3 m cable included with the supply</li> </ul> </li> </ul>	-	-	-	-	1 x	<b>7030.220</b>	-	-
	-	-	-	-	1 x	<b>7030.230</b>	-	-

<sup>1)</sup> Max. 5 pieces for power supply with PoE

# CMC III door control system



## Door Control System DCS

Consisting of:

- Door control module
- Door kit

For automatic opening of TS IT rack doors.

Sample applications:

- Overtemperature in the closed TS IT rack
- Extinguisher gas should be able to enter the rack from the room

Activated via the Door Control Module (DCM) control unit. One DCM activates one rack with 2 doors (front/rear door). We recommend the use of CMC III and access sensors.

### Note:

The following door kits may be connected:

- 2 door kits (magnetic systems with dampers) 7030.240/.241/.250 (required for all applications, Model No. depending on door version)
- 2 door kits (spindle motor) 7030.261 (for applications with underpressure in the rack, e.g. LCP, powerful server fan motors etc.).
- All the power packs used must be connected to the same power supply as the servers, extinguisher systems or LCPs

Activation in case of alarm:

- CMC III task
- DCM, integral temperature sensor
- DCM, digital input

Activation for user access:

- One door switch/comfort handle 7320.793/.794 per door, see page 556
- Coded lock/transponder reader 7030.220/230, see page 553



### Also required:

- Door control module DCM, see page 555
- Door kits, see page 555
- Power supply unit, see page 557
- Connection cable, see page 558
- Mounting unit, 1 U, see page 558



### Accessories:

- CMC III Processing Unit/Compact with connection, power supply and mounting accessories, see from page 548
- Door switch/comfort handle, see page 556
- Coded lock/transponder reader, see page 553
- Access sensor, see from page 550

## System diagram – Door Control System:

- A maximum of 16 door control modules per Processing Unit
- A maximum of 4 door control modules may be connected per Processing Unit Compact

CMC III

- Processing Unit
- Processing Unit Compact

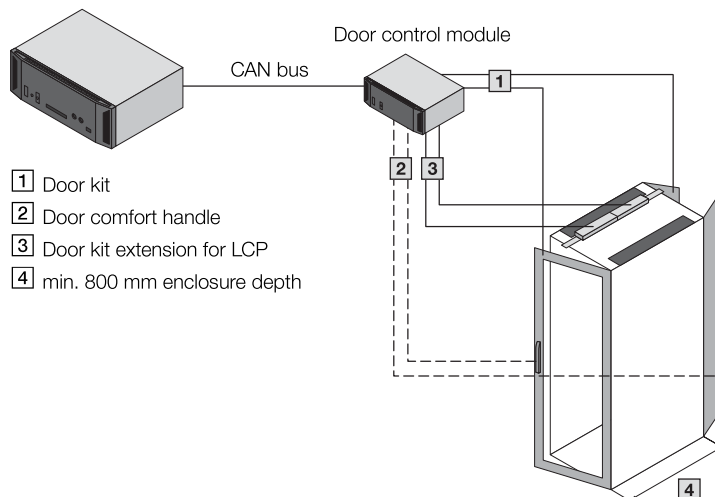

# CMC III door control system

## Door control module

Control unit for automatic opening of TS IT rack doors. Designed for a rack with front and rear door. To fit CMC III system with CAN bus.

### Material:

- Plastic

### Colour:

- Front: RAL 9005
- Enclosure: RAL 7035

### Supply includes:

- Basic system
- 4 mounting feet
- Quick-start instructions



### Also required:

- Door kits, see page 555
- Power supply unit, see page 557
- Connection cable, see page 558
- Mounting unit, 1 U, see page 558



### Accessories:

- CAN bus cable, see page 557
- Door switch/comfort handle, see page 556
- Coded lock/transponder reader, see page 553



Model No.	7030.500
Packs of	1 pc(s).
Maximum no. of PU/PU Compact	16/4
1st rated voltage	24 V (DC) Door Control Module via CMC III CAN bus, redundant to 2nd rated voltage
2nd rated voltage	24 V (DC) 7030.060 for door control module and magnet systems
3rd rated voltage	24 V (DC) 7030.060 for spindle motors only (protected by a UPS)
1 x temperature sensor input	NTC sensor (included with the supply)
3 x digital inputs	Alarm/front door/rear door
1 x input for reader units	Coded lock/transponder reader
2 x outputs for door kits	Magnetic system with damper
2 x outputs for door kits extension	Spindle motors
2 x CAN bus CMC III	RJ 45 for CAN bus cable

## Door kit

### for TS IT (magnetic system with damper)

To open the door in an emergency situation.

Connection and activation via door control module, for standard TS IT doors. The doors are kept closed by a magnetic system. If the power supply to the magnets is interrupted, the gas pressure damper system pushes the door open.

### Technical specifications:

- Rated voltage: 24 V DC
- Rated current 7030.240/241: 390 mA
- Rated current 7030.250: 520 mA

### Material:

- Sheet steel

### Surface finish:

- Zinc-plated

TS IT design	Packs of	Model No.
1-piece aluminium glazed door	1 pc(s).	<b>7030.240</b>
1-piece sheet steel door	1 pc(s).	<b>7030.241</b>
2-piece door	1 pc(s).	<b>7030.250</b>

### Supply includes:

- Gas pressure damper
- Cable harness
- Magnetic system with damper
- Instructions
- Assembly parts



### Also required:

- Door control module DCM, see page 555
- For 7030.250: Tubular door frame, see page 659



# CMC III door control system



## Door kit extension

### for TS IT, LCP (spindle motor)

To open the door in an emergency situation. For applications with underpressure in the rack, e.g. LCP, powerful server fan motors etc., this kit is required in addition to the magnetic lock. The motor pushes the door open until the underpressure is released. It is mounted on the roof.

#### Technical specifications:

- Rated current: 900 mA
- Push force: 1000 N
- Stroke length: max. 200 mm

#### Material:

- Sheet steel
- Aluminium
- Plastic

Packs of	Model No.
2 pc(s).	7030.261

#### Supply includes:

- 2 spindle motors
- 2 push frames
- Instructions
- Assembly parts



#### Also required:

- Door control module DCM, see page 555
- Door kits, see page 555
- Power supply unit (with UPS protection), see page 557



## Door comfort handle

### with door opener function

By actuating the lock mechanism, the door is released via the automatic door opening system. Prepared for the installation of standard commercially available semi-cylinders, 40 mm, and lock and push-button inserts. Length: 302 mm.

#### Technical specifications:

- Rated voltage: 24 V (DC)
- Rated current: max. 3 A
- Connection cable: Length 3 m
- Temperature application range: +5°C...+40°C

#### Colour:

- RAL 7035

Packs of	Model No.
1 pc(s).	7320.794



#### Also required:

- Handle adaptor for mounting on glazed door 8611.080, see page 659



#### Accessories:

- Lock and push-button inserts, see page 674



## Door switch

Switch with normally-closed contact for door control module 7320.790, for manual door opening. It is mounted on the 25 mm pitch pattern of the TS IT frame section.

#### Technical specifications:

- Installation: Ø 16.2 mm
- 250 V/2 A

Packs of	Model No.
1 pc(s).	7320.793

#### Supply includes:

- 3 m connection cable
- Mounting bracket
- Assembly parts



## Power supply unit

for PU, PU Compact, CAN bus unit, CAN bus DRC, Door Control System.

The power pack is specifically tailored to the CMC III design and may be positioned in a CMC III mounting unit. As well as a special connector for the CMC III Processing Unit/Compact, there are also two further terminals available as 24 V outputs.

### Technical specifications:

- Input voltage: 100 – 240 V / 50/60 Hz
- Output voltage: 24 V (DC)/2,5 A
- Length of 24 V DC connection cable: 0.6 m

### Dimensions:

- W x H x D: 138 x 40 x 120 + 12 mm front frame

### Material:

- Plastic

### Surface finish:

- Front: Smooth
- Enclosure: Textured

### Colour:

- Front: RAL 9005
- Enclosure: RAL 7035

### Supply includes:

- Assembly parts
- Instructions

Packs of	Model No.
1 pc(s).	<b>7030.060</b>



### Also required:

- Connection cable, see page 558



### Accessories:

- Mounting unit, see page 559



## Programming cable

For first-time commissioning of the Processing Unit (PU) or PU Compact. During initial start-up, the programming cable connects the CMC III Processing Unit/Compact to the USB interface of a PC.

A driver for Windows systems is also included with the supply and must be installed on the PC.

### Supply includes:

- CD with driver and system description

Packs of	Model No.
1 pc(s).	<b>7030.080</b>



## CAN bus connection cable

This can be used to connect the PU to the CAN bus sensors III, units III and control units III as a bus.

Also for cabling the CAN bus sensors III, units III and control units III together.

Because it is available in different lengths, the CMC III system can be adapted to various applications and built to a custom design.

CMC III CAN bus connection cable	Length m	Packs of	Model No.
RJ 45	0.5	1 pc(s).	<b>7030.090</b>
RJ 45	1	1 pc(s).	<b>7030.091</b>
RJ 45	1.5	1 pc(s).	<b>7030.092</b>
RJ 45	2	1 pc(s).	<b>7030.093</b>
RJ 45	3	1 pc(s).	<b>7030.480</b>
RJ 45	4	1 pc(s).	<b>7030.490</b>
RJ 45	5	1 pc(s).	<b>7030.094</b>
RJ 45	10	1 pc(s).	<b>7030.095</b>



# CMC III



## Connection cable/extension

For connecting to:

- CMC III power pack C13
- CMC III power unit C13
- PDU C19

### Technical specifications:

- PVC cable, 3-pole, with IEC 60 320 cable coupling (non-heating appliances) with contact protection CEE22
- Length: Minimum 1.8 m

Country version	Voltage (V)	Packs of	Model No.
D/F/B/C13	230	1 pc(s).	<b>7200.210</b>
IEC 320 device extension C13/C14	230/115	1 pc(s).	<b>7200.215</b>
Connection cable D/C19	230/115	1 pc(s).	<b>7200.216</b>
Connection cable C19/C20	230/115	1 pc(s).	<b>7200.217</b>



## Extension cable RJ 12

### with RJ 12 connector/jack

To extend the cable connections to CMC-TC sensors.

Length m	Packs of	Model No.
1	2 pc(s).	<b>7320.814</b>



## Mounting unit, 1 U

Makes it easier to install CMC III units in network and server enclosures.

The mounting unit can accommodate up to 3 units and is secured in the 482.6 mm (19") frame.

To accommodate

- PU
- PU Compact
- Control units
- CMC III CAN bus unit
- CMC III CAN bus DRC
- CMC III power pack
- CMC III GSM/ISDN unit
- CMC III door control module

### Benefits:

- Fire protection: Self-extinguishing to UL 94-HB

Packs of	Model No.
1 pc(s).	<b>7030.088</b>

### Material:

- Plastic

### Colour:

- RAL 9005

### Supply includes:

- 2 blanking covers
- Assembly parts



### Accessories:

- Cable clamp strap 7030.087, see page 558



## Cable clamp strap

For tool-free attachment to the rear of the CMC III 482.6 mm (19") mounting unit 7030.088. Enables tidy cable routing behind the built-in CMC III devices and can be used to attach cables for strain relief purposes. Cables are easily laid in a loop to allow the built-in CMC III devices to be removed from the mounting unit without the need for tools.

### Applications:

- Cable management

### Benefits:

- Cable support
- Fire protection: Self-extinguishing to UL 94-HB

### Operating temperature range:

- +0°C...+55°C

### Operating humidity range

- 5% - 95%

Packs of	Model No.
1 pc(s).	<b>7030.087</b>

### Material:

- Plastic

### Colour:

- RAL 9005

### Supply includes:

- Assembly parts

## Mounting unit

To accommodate one CMC III unit and for mounting on the enclosure frame

To accommodate

- PU
- PU Compact
- Control units
- CMC III CAN bus unit
- CMC III CAN bus DRC
- CMC III power pack
- CMC III GSM/ISDN unit
- CMC III door control module

**Material:**

Sheet steel

**Surface finish:**

– Zinc-plated

Packs of	Model No.
1 pc(s).	7030.071



## CMC III GSM unit

For configuring a redundant transmission channel or, if there is no network infrastructure available, for alarm forwarding. The alarm signal is designed in text message format. Covering 4 GSM frequencies (quad-band): 850 MHz, 900 MHz, 1800 MHz and 1900 MHz. A standard, commercially available SIM card must be provided by the customer.

**Material:**

– Plastic

**Colour:**

- Front: RAL 9005
- Enclosure: RAL 7035

**Supply includes:**

- RJ 12 cable
- GSM aerial
- Assembly parts
- Instructions

Packs of	Model No.
1 pc(s).	7030.570



## Interference suppressor for fans

**for CMC III**

For connecting fans via the CMC III Power Unit 7030.050. The interference suppressor prevents excessive startup currents. One interference suppressor is required for each fan.

**Material:**

– Plastic

**Colour:**

– RAL 9005

**Supply includes:**

– Assembly parts

Packs of	Model No.
1 pc(s).	7030.051

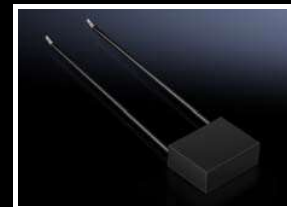

# Dynamic Rack Control DRC

Dynamic Rack Control is an inventory system for data centres, allowing all 482.6 mm (19") components in the rack to be managed easily and clearly.

## Your benefits

- Capacity management and visualisation of all built-in components
- Position logging of components to 1/3 U accuracy
- Storage of key information about the built-in device directly on the tag (zero current)
- Data retrievable via Web browser, with integration and automatic detection via SNMP
- RFID technology to ISO 15693

# Dynamic Rack Control

## RFID aerial

### for TS IT

For insertion into the 482.6 mm (19") section of the TS IT.

Position detection of the components is accurate to within 1/3 U, therefore there are 3 aerial elements and signalling LEDs integrated into each U.

Reading and writing of the RFID tags is likewise signalled by one LED in each case.

### Supply includes:

- Assembly parts

U	Packs of	Model No.
42	1 pc(s).	<b>7890.242</b>
47	1 pc(s).	<b>7890.247</b>



### Also required:

- RFID controller 7890.500, see page 561
- RFID tags 7890.020, see page 561



## RFID tags

1 RFID tag is required for each component. Each tag has a "Unique ID" (UID, not sequential), which cannot be altered; all other data is stored on the tag in conformity with ISO 15693. The tag is stuck to the inside right of the 482.6 mm (19") mounting bracket using its adhesive surface. The component is later screw-fastened to the 482.6 mm (19") level, including the tag.

### Technical specifications:

- Type: passive, writable
- Frequency: 13.56 MHz

Packs of	Model No.
20 pc(s).	<b>7890.020</b>



## RFID controller

Connects the RFID aerial to the CAN bus DRC. In this way, the CMC is able to notify automatic changes, graphically depict the enclosure with the built-in components, and list capacity management. One RFID controller is required for each rack/aerial.

### Connections:

- RJ 45 jack for a maximum of one CAN bus DRC
- Mini-DIN for a maximum of one RFID aerial

### Supply includes:

- Nylon tapes for attachment

Packs of	Model No.
1 pc(s).	<b>7890.500</b>



### Also required:

- CAN bus connection cable, see page 557
- CMC III CAN bus DRC, see page 561
- Attachment



## CMC III CAN bus DRC

For connecting an RFID controller 7890.500 to the PU/PU Compact.

4 CAN bus DRCs may be connected to the Processing Unit, or 2 to the Processing Unit Compact.

Packs of	Model No.
1 pc(s).	<b>7030.550</b>



### Also required:

- CAN bus connection cable, see page 557
- Mounting unit, 1 U, see page 558
- Power supply unit 7030.060, see page 557



# IT management software



## Rizone Appliance Standard

RiZone is supplied as a hardware or software appliance.

As a hardware appliance, RiZone is supplied with global support, installed on a powerful 1 U server. The software appliance is available as a virtual server in Open Virtualization Format (OVF) which is easily used on existing hardware in the data centre.

### Note:

- Both appliances support communication with Rittal devices and devices from third-party manufacturers via an integral MIB browser



### Also required:

- RiZone Appliance IP node licence according to the number of IP nodes available

Standard version	Model No.		
	Hardware appliance <sup>1)</sup>	Server with Windows <b>7990.101</b>	RiZone software <b>7990.201</b>
Software appliance <sup>1)</sup>	Hard drive + Windows <b>7990.103</b>	RiZone software <b>7990.203</b>	RiZone graphics tool <b>7990.303</b>

<sup>1)</sup> All Model Nos. on the same line belong together, and must always be ordered together.



## RiZone Appliance IP node licence

The flexible RiZone licence model allows optimum adaptation to any project size, while at the same time being capable of growing with the data centre.

The volume licences for the IP nodes are graduated with 25 and 100 nodes and may be adapted precisely to the size of the data centre. One node licence is required for each active component or other SNMP-compatible component to be covered.

For no. of IP nodes <sup>1)</sup>	Console licences included	Model No.	
		RiZone software	RiZone graphics tool
25	4	<b>7990.206</b>	<b>7990.306</b>
100	8	<b>7990.208</b>	<b>7990.308</b>

<sup>1)</sup> All Model Nos. on the same line belong together, and must always be ordered together.



## DCIM – Data Centre Infrastructure Management

RiZone – Perfect support of IT infrastructure components.

A comprehensive description of RiZone functions may be found from page 604



## Server shutdown software for CMC III

Client software to control the server shutdown via CMC III. The software supports all common operating systems and versions (e.g. Windows 7, VISTA, XP, Server 2003/2008, UNIX/LINUX and VMWARE Sphere/ESX Server, CITRIX XEN etc). One licence is required for each server to be shut down on an event-controlled basis.

Licences	Model No.
Single licence	<b>7857.421</b>

### Note:

- Software updates and a complete list of currently supported operating systems may be found on the Internet

# Monitor/keyboard unit

## Monitor/keyboard unit, 1 U

With 17" TFT display and VGA/DVI connection

### Main components:

- TFT monitor 17"
- Keyboard, German or English
- Touchpad

The unit is housed in a pull-out drawer. The monitor can be flipped up and the drawer latches into the end position. This means that the unit only requires 1 U in the 482.6 mm (19") rack.

### Benefits:

- With digital and analog interfaces, VGA, DVI-D, PS/2, USB
- Simple one-person assembly
- Optionally with integrated KVM switch for up to 8 servers

### Technical design:

- 432 mm / 17" TFT display
- Physical resolution: 1280 x 1024
- Format: 4 : 3
- Colours: 16.7 million
- Brightness approx. 350 cd/m<sup>2</sup> (typ.)
- Contrast ratio: approx. 1000 : 1
- Mains voltage: 100 – 240 V/50 – 60 Hz
- Ambient temperature: +5°C...+45°C (operation)
- Max. power consumption in operation, without optional KVM system: 32 W
- Max. power consumption with closed monitor unit, without optional KVM system: < 1 W
- Rear connections: Mains voltage, VGA, DVI, PS/2, USB, power supply for KVM
- Lockable at the front
- Cables are safely routed in the energy chain



### Accessories:

- For connecting multiple servers: KVM switch, see page 563

Width	Height U	Depth mm	Installation depth mm	Colour	Keyboard	Packs of	Model No.
482.6 mm / 19"	1	680	680 – 850	RAL 7035	German	1 pc(s).	<b>9055.310</b>
					English	1 pc(s).	<b>9055.312</b>
				RAL 9005	German	1 pc(s).	<b>9055.410</b>
					English	1 pc(s).	<b>9055.412</b>



## KVM switch

### SSC view 8 USB

For rear attachment on the monitor/keyboard unit. The SSC view 8 USB may be operated with up to 8 servers. It is operated via the monitor/keyboard unit with an OSD menu or hotkeys.

### Technical specifications:

- Server/console connections
- Video: VGA/HD15
- Keyboard/mouse: PS/2 or USB
- Max. video resolution: 1280 x 1024 at 85 Hz
- Bandwidth: 200 MHz
- Power consumption: 10 W
- W x H x D: 482.6 x 44 x 140 mm
- Voltage supply: 12 V (DC) via monitor/keyboard unit

### Protection category IP to IEC 60 529:

- IP 20

### Colour:

- RAL 9006

	Packs of	Model No.
SSC view 8 USB	1 pc(s).	<b>7552.002</b>

Connection cable for server/VGA	Length m	Packs of	Model No.
PS/2	2	1 pc(s).	<b>7552.120</b>
PS/2	4	1 pc(s).	<b>7552.140</b>
USB	2	1 pc(s).	<b>7552.122</b>
USB	5	1 pc(s).	<b>7552.142</b>



### Also required:

- Monitor/keyboard unit, see page 563



# Rittal – The System.

Faster – better – everywhere.

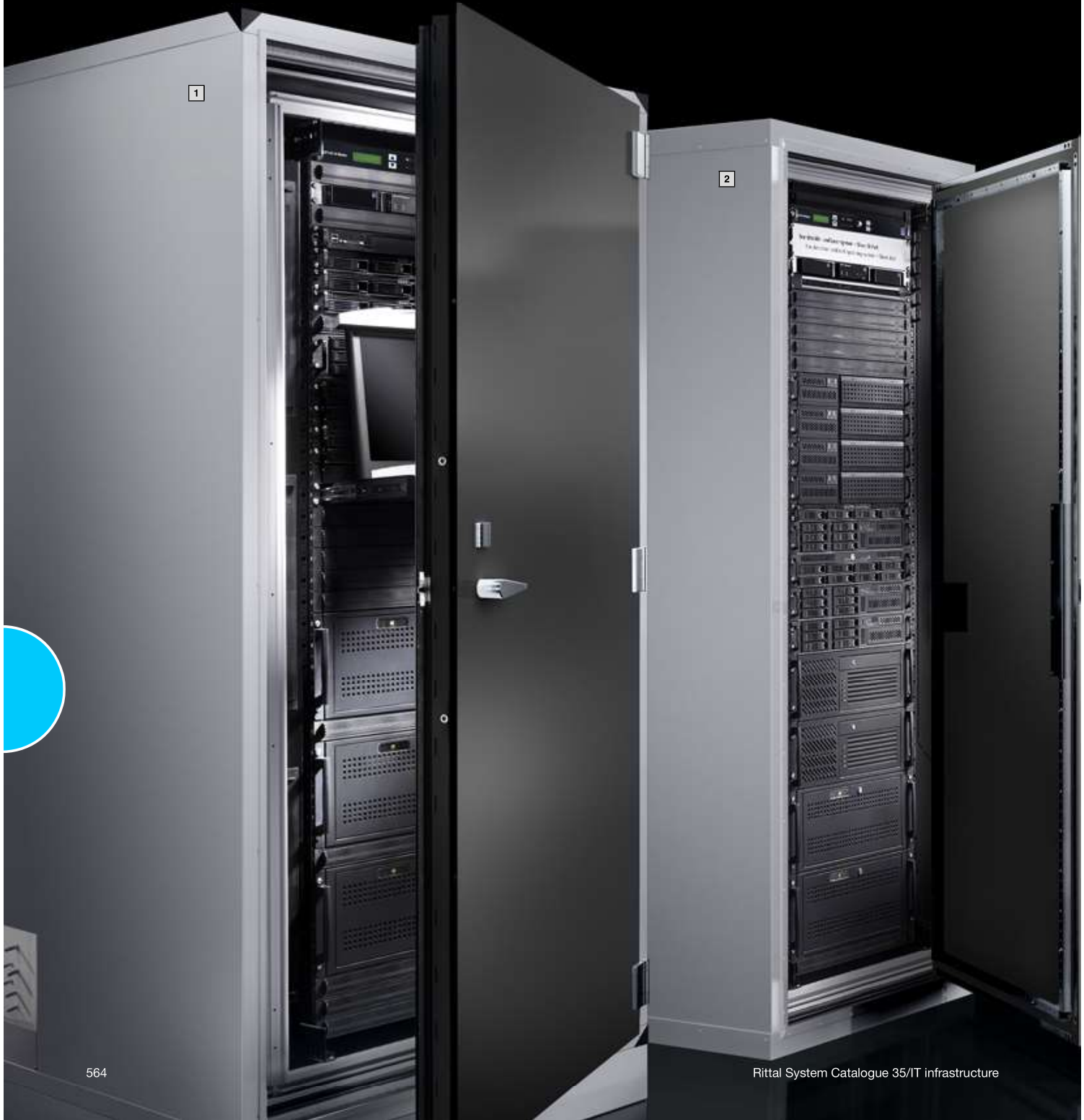



# IT security solutions

---

## Micro Data Center

Level E .....	568
Level B .....	570
Compact cooling .....	572

## Fire alarm and extinguisher system

Fire alarm and extinguisher system DET-AC III master .....	573
Early fire detection system EFD III .....	574
Additional unit DET-AC III slave .....	575
Accessories for DET-AC III/EFD III .....	576

## Security rooms

Security rooms .....	578
----------------------	-----

## Your benefits

- Simple, flexible integration into existing building structures
- Extendible for long-lasting cost-effectiveness and future-proof investments
- Optimum space utilisation, thanks to the flexible modular system
- System-tested protection from potential physical threats
- Compatible with cross-plant IT infrastructures

## Sample applications

- 1 Micro Data Center, Level E with climate control, see page 568
- 2 Micro Data Center, Level B as compact data centre, see page 570

# Micro Data Center



- Complete solution in a minimal space
- No need for expensive upgrades to existing premises

### Level E – High level of protection for your IT

- Maximum security in the Micro Data Center product range
- Optimum protection concept for one or more server rack solutions for small and medium-sized enterprises
- Modular layout for installation in hard-to-access locations and for retrospective enclosure of existing IT structures
- Future-proof investment, thanks to the options of extendibility, dismantling and re-assembly
- System-tested security and a high level of protection; testing has been carried out by accredited institutes and confirmed with test reports
- Modified air baffle plates for optimum air routing, for efficient cooling of the Micro Data Centers

Usable U	42/47	
Usable interior depth mm	1000/1200	
Fire protection	Fire resistance class F 90 to DIN 4102 Part 2, compliance with limits $\Delta T < 50$ K, rel. humidity $< 85\%$ over 30 minutes <sup>1)</sup>	
Burglar resistance	RC 2 tool attack analogous to DIN EN 1630/2011-09/RC 2 <sup>4)</sup> RC 3 tool attack analogous to DIN EN 1630/2011-09/RC 3 <sup>3)</sup> WK 4 tool attack analogous to DIN V ENV 1630/1999-04/WK 4 <sup>3)</sup>	
Protection category	IP 56 to IEC 60 529 <sup>4)</sup>	
Smoke protection	Based on DIN 18 095-2: 1991-03 <sup>4)</sup>	
Modularity	■	
May be enclosed with the system operational	■	
Extendibility	■	

<sup>1)</sup> The Micro Data Centre was tested as a system

<sup>2)</sup> All critical connection points were tested as a system



## Level B – Solid protection for your IT

- Optimum protection concept for a server rack
- Modular layout for installation in hard-to-access locations
- Form-fit connection with the stable TS 8 framework structure
- Front and rear 482.6 mm (19") level of the TS IT rack already included with the supply
- Lower weight than the Level E Micro Data Center
- Tested security – testing has been carried out by accredited institutes and confirmed with test reports

42/47

1000/1200

Fire resistance class EI 90/F 90 to DIN EN 1363-1: 1999 / based on DIN 4102-2:1997<sup>2)</sup>

RC 2 tool attack analogous to DIN EN 1630/2011-09/RC 2<sup>3)</sup>

IP 56 to IEC 60 529<sup>3)</sup>

Based on DIN EN 1634-3: 2005-01<sup>3)</sup>

■

-

-

<sup>3)</sup> The safe for individual siting was tested as a system with single-leaf doors and mechanical lock

<sup>4)</sup> The safe for individual siting was tested as a system with one single-leaf door and one bifold door and mechanical lock

# Micro Data Center



**System accessories** Page 613

**Applications:**

- A high level of protection against potential physical threats for IT components
- Targeted configuration components transform the safe into a complete Micro Data Center

**Benefits:**

- As well as facilitating installation in poorly accessible sites, the modular design also makes it possible to retrospectively enclose existing IT structures.
- Extensibility, dismantling and re-assembly mean targeted, future-safe investments
- Tested security – testing has been carried out by accredited institutes and confirmed with test reports

**Protection standards:**

- Fire protection category F 90 to DIN 4102 Part 2
- Compliance with limit values  $\Delta T < 50$  K, rel. humidity  $< 85\%$  over 30 minutes
- Burglary resistance RC 2, optionally RC 3, tool attack analogous to DIN EN 1630/2011-09 and optionally WK 4, tool attack analogous to DIN V ENV 1630/1999-04/WK 2
- Smoke protection based on DIN 18 095-2: 1991-03

**Material:**

- Sheet steel, coated

**Colour:**

- Enclosure and service door: RAL 7035
- Operator door: RAL 9005

**Protection category IP to IEC 60 529:**

- IP 56

**Supply includes:**

- Micro data center with operator door and service door
- Cable entry in both side elements
- Both doors with key lock

**Optional:**

- Choice of door hinges
- Bifold doors
- Different cable entry systems
- Cable entry additionally in the top or base unit
- Different lock variants
- Supporting structure

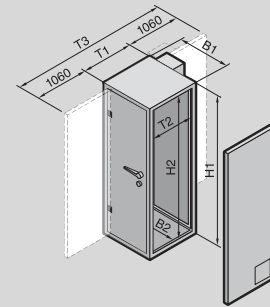

**Note:**

- The Micro Data Center is configured on a project-specific basis

## Level E

U		42	47	42	47	Page
<b>External dimensions mm</b>	Width (B1)	1100	1100	1100	1100	
	Height (H1)	2210	2410	2210	2410	
	Depth (T1)	1200	1200	1400	1400	
	Depth (T3)	3320	3320	3520	3520	
<b>Internal dimensions mm</b>	Width (B2)	920	920	920	920	
	Height (H2)	2030	2230	2030	2230	
	Depth (T2)	1000	1000	1200	1200	
<b>Model No.</b>		<b>7999.009</b>	<b>7999.009</b>	<b>7999.009</b>	<b>7999.009</b>	
<b>Empty weight excluding cooling unit and excluding rack approx. kg</b>		660	700	730	800	
<b>Accessories</b>						
Fire alarm and extinguisher system DET-AC/EFD III		see page	see page	see page	see page	573
CMC III monitoring system		see page	see page	see page	see page	544
PSM – Power System Module busbar		see page	see page	see page	see page	488
PDU – Power Distribution Unit		see page	see page	see page	see page	502
Compact split cooling unit		see page	see page	see page	see page	572
LCU – Liquid Cooling Unit		see page	see page	see page	see page	518

**Standard protection from:**



Fire



Extinguishing water



Corrosive gases



Vandalism



Unauthorised access



Dust



Theft/burglary

## Level E, options

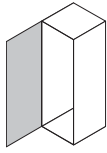
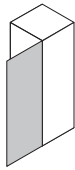
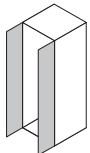
<b>Operator door</b>	L/h DIN door hinge	R/h DIN door hinge	Bifold door
			
	<input checked="" type="checkbox"/>	<input type="checkbox"/>	<input type="checkbox"/>

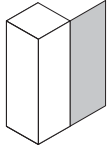
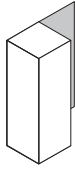
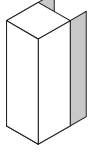

<b>Service door</b>	L/h DIN door hinge	R/h DIN door hinge	Bifold door
			
	<input checked="" type="checkbox"/>	<input type="checkbox"/>	<input type="checkbox"/>

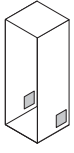
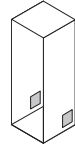
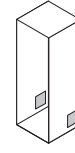
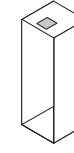
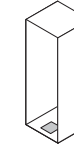
<b>Cable entry</b>	Soft duct <sup>1)</sup> in both side elements	Hard duct <sup>2)</sup> in both side elements	Cable box <sup>3)</sup> in both side elements	Hard duct <sup>2)</sup> in top element	Hard duct <sup>2)</sup> in base element
					
	<input checked="" type="checkbox"/>	<input type="checkbox"/>	<input type="checkbox"/>	<input type="checkbox"/>	<input type="checkbox"/>



- <sup>1)</sup> Size of soft duct: approx. 267 x 165 mm.  
For fire protection reasons, the duct may be configured up to a max. of 60% with a maximum cable diameter of 15 mm and a maximum conduit diameter of 18 mm.
- <sup>2)</sup> Size of hard duct: 2 panels each 120 x 120 mm.  
Cables up to a diameter of 15 mm may be routed through the hard duct.
- <sup>3)</sup> Size of cable box: Field 1 approx. 210 x 44, field 2 approx. 210 x 25 mm.  
Cables up to a diameter of 15 mm and hoses up to a diameter of 44 mm may be routed through the cable box.  
No conduits may be routed through the cable box.

<b>Locks</b>	Key lock with 2 keys	Electronic combination lock <sup>1)</sup>	Electronic combination lock for activation via an access control system supplied by the customer
	<input checked="" type="checkbox"/>	<input type="checkbox"/>	<input type="checkbox"/>

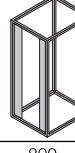

<sup>1)</sup> First code, second code and double code allocation possible. Key-based opening for inspection purposes supported.

<b>TS IT rack with air baffle plates</b>								
	600				800			
Width mm								
Height mm	2000	2200	2000	2200	2000	2200	2000	2200
Depth mm	1000	1000	1200	1200	1000	1000	1200	1200
	<input type="checkbox"/>	<input type="checkbox"/>	<input type="checkbox"/>	<input type="checkbox"/>	<input type="checkbox"/>	<input type="checkbox"/>	<input type="checkbox"/>	<input type="checkbox"/>



<b>Supporting structure</b>	Steel supporting structure to compensate for the raised floor height when siting the modular safe on the bare floor. The height of the supporting structure is selectable between 100 mm and 1000 mm.	Steel supporting structure to compensate for the raised floor height when siting the modular safe on the bare floor. The supporting structure has a fire-proof covering. The height of the supporting structure is selectable between 100 mm and 1000 mm.
	<input type="checkbox"/>	<input type="checkbox"/>

■ Included with the supply □ Optional

# Micro Data Center



**System accessories** Page 613

**Applications:**

- Basic protection against potential physical threats for IT components
- Targeted configuration components transform the safe into a complete Micro Data Center

**Benefits:**

- Modular layout for installation in hard-to-access locations
- Lower weight than the Level E Micro Data Center
- Tested security – testing has been carried out by accredited institutes and confirmed with test reports

**Protection standards:**

- Fire protection – fire resistance class EI 90/F 90 to DIN EN 1363-1: 1999 based on DIN EN 4102-2: 1997
- Burglar resistance RC 2 Tool attack analogous to DIN EN 1630/2011-09/RC 2
- Smoke protection based on DIN EN 18 1634-3: 2005-01

**Material:**

- Sheet steel, coated

**Colour:**

- Enclosure and service door: RAL 7035
- Operator door: RAL 9005

**Protection category IP to IEC 60 529:**

- IP 56

**Supply includes:**

- Security safe with integral TS 8 frame
- Front and rear 482.6 mm (19") level
- Adjusted air baffle plates
- Every side element is prepared for one cable entry at the bottom and one cable entry at the top
- Operator and service door with swing-lever handle and semi-cylinder

**Optional:**

- Choice of door hinges
- Bifold doors
- Different cable entry systems
- Cable entry additionally in the top and base element
- Different lock variants
- Supporting structure with fire protection

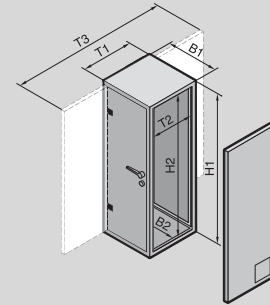

**Note:**

- The Micro Data Center is configured on a project-specific basis

## Level B

U		42	47	42	47	Page
<b>External dimensions</b> mm	Width (B1)	1115	1115	1115	1115	
	Height (H1)	2205	2405	2205	2405	
	Depth (T1)	1377	1377	1577	1577	
	Depth (T3)	3274	3274	3474	3474	
<b>Internal dimensions</b> mm	Width (B2)	905	905	905	905	
	Height (H2)	2000	2200	2000	2200	
	Depth (T2)	1060	1060	1260	1260	
<b>Model No.</b>		<b>7999.709</b>	<b>7999.709</b>	<b>7999.709</b>	<b>7999.709</b>	
<b>Empty weight excluding cooling unit</b> approx. kg		595	630	660	700	

**Accessories**

Fire alarm and extinguisher system DET-AC/EFD III	see page	see page	see page	see page	573
CMC III monitoring system	see page	see page	see page	see page	544
PSM – Power System Module busbar	see page	see page	see page	see page	488
PDU – Power Distribution Unit	see page	see page	see page	see page	502
Compact split cooling unit	see page	see page	see page	see page	572
LCU – Liquid Cooling Unit	see page	see page	see page	see page	518

**Standard protection from:**



Fire



Extinguishing water



Corrosive gases



Vandalism



Unauthorised access



Dust



Theft/burglary

## Level B, options

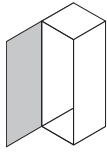
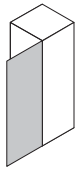
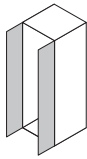
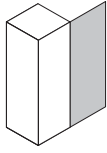
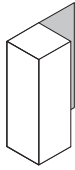
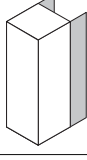
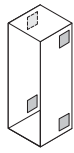
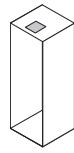
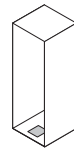
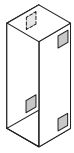
<b>Operator door</b>	L/h DIN door hinge	R/h DIN door hinge	Bifold door	
				
	■	□	□	
<b>Service door</b>	L/h DIN door hinge	R/h DIN door hinge	Bifold door	
				
	■	□	□	
<b>Cable entry</b>	Soft duct <sup>1)</sup> in both side elements	Cable box <sup>2)</sup> in top element	Cable box <sup>2)</sup> in base element	Cable box <sup>2)</sup> in both side elements
				
	■	□	□	□
<b>Locks</b>	Swing lever handle with interchangeable semi-cylinder	Swing lever handle with electronic lock for external activation	Swing lever handle with electronic lock with combination code	
	■	□	□	
<b>Supporting structure</b>	Steel supporting structure to compensate for the raised floor height when siting the modular safe on the bare floor. The supporting structure has a fire-proof covering. The height of the supporting structure is selectable between 100 mm and 1000 mm.			
	□	□	□	

■ Included with the supply □ Optional



# Micro Data Center



**System accessories** Page 613

For cooling the Micro Data Center Level B and Level E. The split cooling unit is comprised of an internal unit (evaporator coil) and an external unit, whereby the internal unit is secured to the side panel on the inside of the Micro Data Center, and the external unit to the service door.

**Benefits:**

- Separate, hermetically sealed internal and external circuits
- Dust and flue gas are unable to ingress
- The internal and external unit are connected to one another via refrigerant lines and control cables, and shielded for fire protection
- Air routing in the Micro Data Center is horizontal. Modified air baffle plates ensure targeted air routing. By separating the "cold side" from the "hot side", air short-circuits are avoided, and the efficiency of cooling is enhanced.

**Temperature control:**

- Comfort controller (factory setting +25°C)

**Colour:**

- RAL 7035

**Protection category IP to IEC 60 529:**

- IP 24

**Supply includes:**

- Internal unit (evaporator coil)
- External unit
- Refrigerant lines
- Data and supply cables

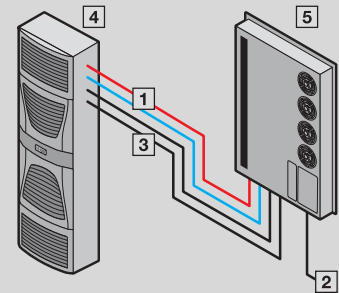

- 1 Flexible refrigerant lines inlet/return
- 2 Power supply
- 3 Data cable
- 4 External unit
- 5 Internal unit

## Compact cooling for Micro Data Center

<b>Model No.</b>	<b>3126.230</b>
Weight kg	160.0
Dimensions W x H x D, external unit mm	500 x 1580 x 231
Dimensions W x H x D, internal unit mm	804 x 1544 x 100
Total cooling output 50/60 Hz L35 L35 W	2500/3090
Total cooling output 50/60 Hz L35 L50 W	2070/2300
Power consumption P <sub>el</sub> 50/60 Hz L35 L35 W	1275/1615
Power consumption P <sub>el</sub> 50/60 Hz L35 L50 W	1525/1920
Rated operating voltage V, ~, Hz	400, 3~, 50/460, 3~, 60
Rated max. current A	3.3/3.5
Start-up current A	14.2/14.7
Pre-fuse A	6.3/10.0
Motor circuit-breaker	■
Refrigeration factor $\epsilon = \dot{Q}_k/P_{el}$ L35 L35	2
Refrigerant g	R134a,1500
Permissible operating pressure (p. max.) bar	28
Operating temperature range	+20°C...+35°C
Noise level max. dB(A)	70



# Fire alarm and extinguisher system



System accessories Page 613 Network/server enclosures TS IT Page 100 Micro Data Center Page 566

The active extinguisher system includes the smoke extraction system and the extinguisher unit. The smoke extraction system is identical to the smoke extraction system in the EFD III. The extinguishing process begins automatically when a main alarm is activated. For the extinguishing process, the tank is pressurised via a propellant cartridge. The extinguisher gas Novec™ 1230 evaporates at the extinguisher nozzle and is distributed in the server enclosure.

#### Benefits:

- Early fire detection
- Automatic extinguishing
- Innovative extinguisher Novec™ 1230: eco-friendly, non-critical for IT components, non-conductive
- 482.6 mm (19") rack mount with just 1 U
- Tested by VdS Schadenverhütung GmbH
- CAN bus interface to the CMC III monitoring system
- Floating relay outputs (pre-alarm/main alarm/collective fault)

#### Material:

- Sheet steel

#### Colour:

- Enclosure: RAL 7035
- Front: RAL 9005

#### Protection category IP to IEC 60 529:

- IP 30

#### Note:

- This system is designed solely for use in closed, non-accessible enclosure systems with a maximum volume of 2.8 m<sup>3</sup>.

## DET-AC III master

Width mm	Packs of	482.6	Page
Height mm		44	
Depth mm		660	
Weight kg		21.5	
<b>Model No.</b>	1 pc(s).	<b>7338.121</b>	
Operating temperature range		+10°C...+40°C	
Storage temperature range without batteries		-20°C...+65°C	
Storage temperature range of batteries		-15°C...+40°C	
Ambient humidity (non-condensing) %		96	
Rated operating voltage V, -, Hz		100 - 240, 1~, 50/60	
Emergency power supply		approx. 4 h	
Airflow monitoring		approx. ±10% of total airflow	
Interfaces		4x/3x relay outputs for alarms and faults (terminals/RJ12 jacks) 1x/1x input for door contact switch (terminal/RJ12 jack) 2 x CAN connections for master-slave networking 2 x connection (external alarm/manual triggering device) 1 x voltage output for DET-AC slave III (24 V DC max. 500 mA) 1 x USB 2 x CAN bus interfaces to CMC III (max. 16 on PU/4 on PU Compact)	
Sensors		Optical smoke detector (sensitivity: approx. 3.5%/m light obscuration) Optical smoke detector HS (sensitivity: approx. 0.25%/m light obscuration)	
Display		Plain-language display with 6 LEDs	
Technical specifications		Extinguisher is emitted via a propellant cartridge, with integral electrical activation unit Integral extinguisher monitoring (indication of >15% loss)	
Tank: Material/volume l		Aluminium / 2	
Extinguisher: Type/fill volume l		Novec™ 1230 / 1.8	
<b>Also required</b>			
CMC III sensors	2 pc(s).	7320.530	551
CMC III CAN bus connection cable	1 pc(s).	7030.091	504
Sealing kit for TS IT and LCP	1 pc(s).	7338.135	576
Pipe kit	1 pc(s).	7338.130	576
Slide rails, depth-variable	2 pc(s).	5501.480	807

# Early fire detection system



**System accessories** Page 613 **Network/server enclosures TS IT** Page 100 **Micro Data Center** Page 566

The EFD III early fire detection system includes the smoke extraction system in a 482.6 mm (19") subrack with just 1 U. An integral fan continuously extracts air from the area being protected via a system of pipes. The air drawn in passes two fire detectors. If smoke is detected, the highly sensitive detector will emit a pre-alarm, while the second detector will activate the main alarm. The fire detectors are permanently monitored for correct functioning by the evaluation and control electronics on the control card.

**Benefits:**

- Early fire detection
- 482.6 mm (19") rack mount with just 1 U
- Tested by VdS Schadenverhütung GmbH
- CAN bus interface to the CMC III monitoring system
- Floating relay outputs (pre-alarm/main alarm/collective fault)

**Material:**

- Sheet steel

**Colour:**

- Enclosure: RAL 7035
- Front: RAL 9005

**Protection category IP to IEC 60 529:**

- IP 30

**Note:**

- This system is designed solely for use in closed, non-accessible enclosure systems.

## EFD III

Width mm	Packs of	482.6	Page
Height mm		44	
Depth mm		490	
Weight kg		15.0	
<b>Model No.</b>	1 pc(s).	<b>7338.221</b>	
Operating temperature range		+10°C...+40°C	
Storage temperature range without batteries		-20°C...+65°C	
Storage temperature range of batteries		-15°C...+40°C	
Ambient humidity (non-condensing) %		96	
Rated operating voltage V, ~, Hz		100 - 240, 1~, 50/60	
Emergency power supply		approx. 4 h	
Airflow monitoring		approx. ±10% of total airflow	
Interfaces		4x/3x relay outputs for alarms and faults (terminals/RJ12 jacks) 1x/1x input for door contact switch (terminal/RJ12 jack) 2 x CAN connections for master-slave networking 3 x connection (external alarm/manual call point/tank and fill level) 1 x voltage output for DET-AC slave III (24 V DC max. 500 mA) 1 x USB 2 x CAN bus interfaces to CMC III (max. 16 on PU/4 on PU Compact)	
Sensors		Optical smoke detector (sensitivity: approx. 3.5%/m light obscuration) Optical smoke detector HS (sensitivity: approx. 0.25%/m light obscuration)	
Display		Plain-language display with 6 LEDs	
<b>Also required</b>			
CMC III CAN bus connection cable	1 pc(s).	7030.091	504
Pipe kit	1 pc(s).	7338.130	576
Slide rails, depth-variable	2 pc(s).	5501.480	807



**System accessories** Page 613 **Network/server enclosures TS IT** Page 100 **Micro Data Center** Page 566

This add-on unit to the DET AC III Master includes an additional extinguisher unit. In addition to the DET-AC III unit, a DET-AC III slave unit is used for each additional bayed enclosure and supplies the extinguishing agent for that enclosure. Detection occurs via the DET-AC III master system, even when multiple enclosures are bayed together. If a main alarm is reported, the DET-AC III Master will activate extinguishing in all systems simultaneously.

**Benefits:**

- Innovative extinguisher Novec™ 1230: eco-friendly, non-critical for IT components, non-conductive
- 482.6 mm (19") rack mount with just 1 U
- Tested by VdS Schadenverhütung GmbH
- CAN bus interface to the CMC III monitoring system
- In conjunction with the DET-AC III Master, extinguishes up to five racks in an enclosure suite
- May be used in combination with EFD III
- Floating relay outputs (pre-alarm/main alarm/collective fault)

**Material:**

- Sheet steel

**Colour:**

- Enclosure: RAL 7035
- Front: RAL 9005

**Protection category IP to IEC 60 529:**

- IP 30

**Note:**

- This system is designed solely for use in closed, non-accessible enclosure systems with a maximum volume of 2.8 m<sup>3</sup>.

## DET-AC III slave

Width mm	Packs of	482.6	Page
Height mm		44	
Depth mm		660	
Weight kg		19.1	
<b>Model No.</b>	1 pc(s).	<b>7338.321</b>	
Operating temperature range		+10°C...+40°C	
Storage temperature range without batteries		-20°C...+65°C	
Storage temperature range of batteries		-15°C...+40°C	
Ambient humidity (non-condensing) %		96	
Rated operating voltage V		24 (DC)	
Emergency power supply		approx. 4 h	
Interfaces		4x/3x relay outputs for alarms and faults (terminals/RJ12 jacks) 1x/1x input for door contact switch (terminal/RJ12 jack) 2 x CAN connections for master-slave networking 2 x connection (external alarm/manual triggering device) 1 x voltage output for DET-AC slave III (24 V DC max. 500 mA) 1 x USB 2 x CAN bus interfaces to CMC III (max. 16 on PU/4 on PU Compact)	
Technical specifications		Extinguisher is emitted via a propellant cartridge, with integral electrical activation unit Integral extinguisher monitoring (indication of > 15% loss)	
Tank: Material/volume l		Aluminium / 2	
Extinguisher: Type/fill volume l		Novec™ 1230 / 1.8	
<b>Also required</b>			
CMC III sensors	2 pc(s).	7320.530	551
Sealing kit for TS IT and LCP	1 pc(s).	7338.135	576
Pipe kit	1 pc(s).	7338.130	576
Slide rails, depth-variable	2 pc(s).	5501.480	807

# Fire alarm and extinguisher system

## Accessories



### Pipe kit

#### for DET-AC III/EFD III

Non-adhesive plug-in system for connecting to the DET-AC III fire alarm and extinguisher system and the EFD III early fire detection system.

#### Functions:

- The system fans continuously draw air out of the protected area via this pipe system.

#### Technical specifications:

- Diameter of plastic pipe: 18 mm internal, 22 mm external

#### Colour:

- Black

#### Supply includes:

- 3 plastic pipes @ 1 m
- T-piece
- 2 connector pieces, straight
- 4 connection brackets, 90°
- 2 end caps
- Assembly parts

Packs of	Model No.
1 pc(s).	7338.130

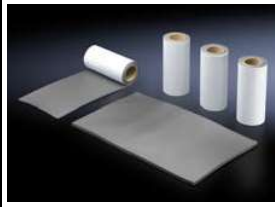

### Sealing kit for TS IT and LCP

#### In conjunction with DET-AC III master/slave

For closing openings in TS IT network/server enclosures and Liquid Cooling Packages when using a DET-AC III fire alarm and extinguisher system.

#### Applications:

- Closes 4 brush strips in the roof plate of the TS IT rack
- Closes 1 brush strip in the roof plate of the LCP
- Closes the opening in the base of the LCP CW/LCP DX in the vicinity of the refrigerant/water lines

#### Benefits:

- Sealing of cable, hose and pipe glands in the roof and base section without impairing their function

#### Material:

- Polythene foam, self-adhesive on one side

#### Colour:

- Anthracite

#### Supply includes:

- 4 blanks to fit two TS IT roof plates
- 1 blank for an LCP

Packs of	Model No.
1 pc(s).	7338.135

# Rittal – The System.

Faster – better – everywhere.

## Micro Data Center configurator – For individual configuration of your security safe



ENCLOSURES

POWER DISTRIBUTION

CLIMATE CONTROL

IT INFRASTRUCTURE

SOFTWARE & SERVICES

FRIEDHELM LOH GROUP



# Security rooms



**IT power** Page 483 **IT cooling** Page 513 **IT monitoring** Page 543

## The basic protection room



The basic protection room provides a high-quality, system-tested solution. It is an optimum, modular room-within-a-room solution for protecting IT/infrastructure components such as extinguisher systems, uninterruptible power supplies and climate control. The flexible modular system means that it can be extended whilst the IT systems are operational.

## The basic protection plus room

Alongside the features of the basic protection room, the basic protection plus room has a higher standard of fire protection and, optionally, a higher level of burglary resistance. This means solid basic protection for your IT.

## Benefits:

- System-tested protection levels
- Multi-functional risk coverage
- Dust- and noise-reduced installation
- Dismantling and reassembly plus extendibility = investment security
- May be bayed to other room systems, such as the High Availability room

Criterion	Standards	
<b>System testing</b>	 Testing to the following standards as a complete system or construction	
<b>Fire protection</b>	 ECB-S certification to EN 1047-2, 50 K temperature increase and 85% rel. humidity up to 24 hours (reheat period), 60 minutes flame impingement time	
	50 K temperature increase and 85% rel. humidity without reheat period, flame impingement time 30 minutes	
	F 120 to DIN 4102; EI 120 (wall) to EN 1363	
	F 90 to DIN 4102 EI 90 to EN 1363	
<b>Corrosive fire gases</b>	Acrid gas-tightness based on EN 18 095	
<b>Falling debris</b>	Impact test 200 kg from a drop height of 1.5 m with impact energy of 3,000 Nm	
<b>Water</b>	Protection category IP X6 to IEC 60 529 Protection from standing water	
<b>Dust</b>	Protection category IP 5X to IEC 60 529	
<b>Unauthorised access</b>	Resistance class RC IV, tool attack analogous to DIN/EN 1630, door system only	
	Resistance class RC III, tool attack analogous to DIN/EN 1630	
	Resistance class RC II, tool attack analogous to DIN/EN 1630	
<b>Explosion</b>	Detonation test	
<b>EMC</b>	Protection from high-frequency irradiation and radiation	

System-tested structures are tested as a complete construction, comprising the cell structure and built-in modules such as doors, cable shields or ventilation units. By contrast, generic component testing only refers to individual parts.

Conventional construction methods refer to room structures made of plasterboard, concrete and other standard construction materials which do not offer sufficient protection for data centre applications. Conventional construction methods are generally unsuitable for use as a fire wall and are therefore only subjected to component testing.



**System accessories** Page 613 **Network/server enclosures** Page 100

### The High Availability room

The High Availability room offers maximum physical protection for data centres and IT system locations. The system was certified by ECB (European Certification Body GmbH) to ECB-S regulations. This certification confirms that the High Availability room meets the requirements of EN 1047-2 without restriction. Moreover, the construction of the security room is subject to continuous quality monitoring by an independent agent.

### Benefits:

- System-tested high availability protection
- Multi-functional risk coverage
- Dust- and noise-reduced installation
- Dismantling and reassembly plus extendibility = investment security
- ECB-S certification
- Independent quality monitoring
- May be bayed to other room systems, such as the basic protection room

	Basic protection room	Basic protection plus room	High availability room
	■	■	■
	-	-	■
	-	■	-
	-	-	■
	■	■	■
	■	■	-
	■	■	■
	■	■	■
	■	■	■
	-	-	■
	■	■	■
	-	-	■
	-	□	■
	■	■	■
	-	-	■
	□	□	□

■ Standard □ Optional

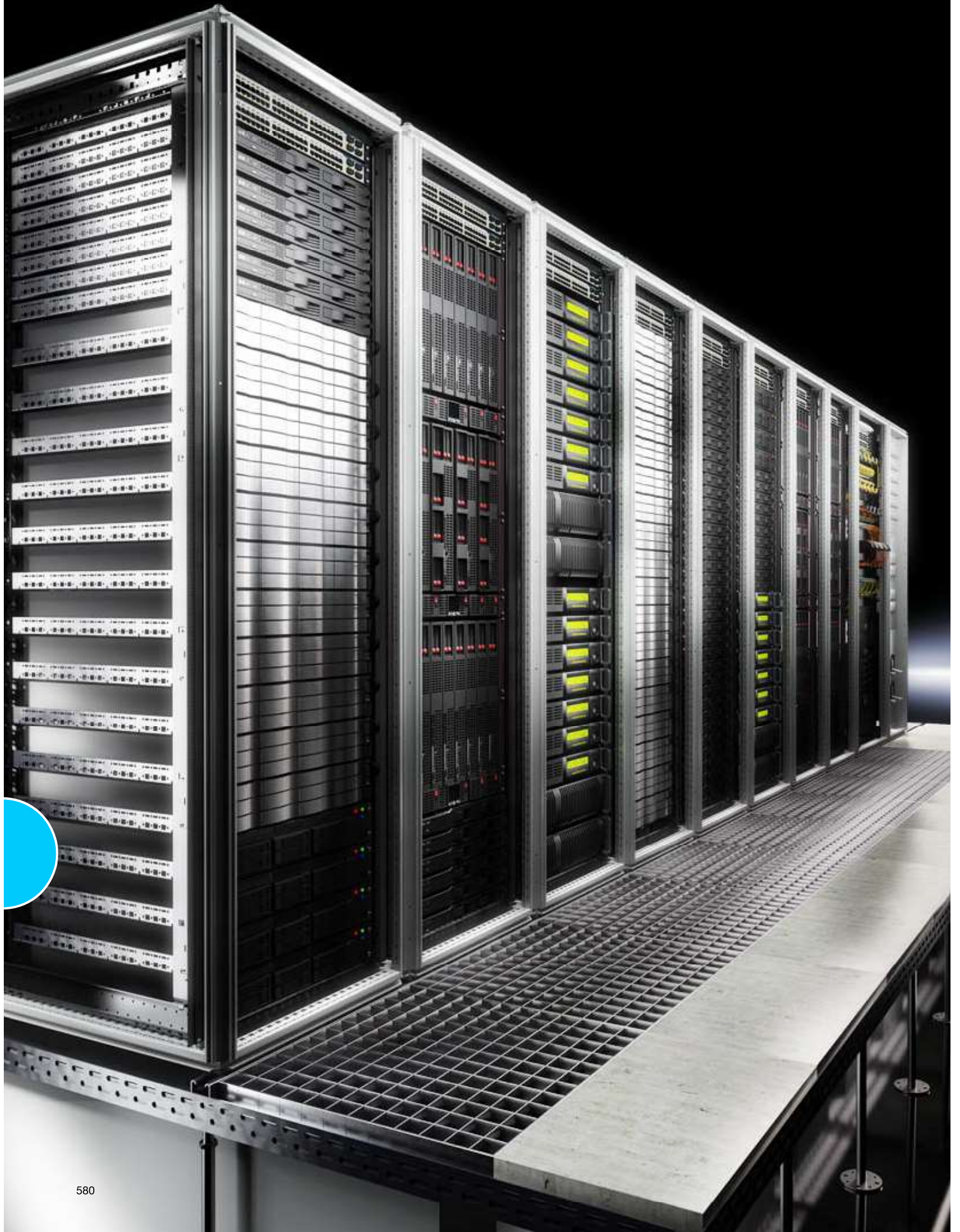



# Modular data centre solutions

## Edge Data Center

Configurator .....583

## RiMatrix S

RiMatrix S at a glance .....584  
Cooling station .....587  
Standard room .....588  
Standard security room .....589  
Standard container .....590

## Container solutions

Data Centre Container DCC .....591  
Balanced Cloud Center BCC .....593  
Lefdal Mine Datacenter .....595

## Your benefits

- Standardised data centre infrastructures based on data centre modules
- Tested, documented modules with outstanding efficiency
- Simplified planning with pre-configuration
- Available off the shelf
- Guaranteed efficiency ratings (PuE)
- Simplified service and administration processes
- Standard Container in ISO and non-ISO version from 20 ft – 40 ft



## RiMatrix S app

Your selector for standardised data centres for SMEs, branch concepts and flexible cloud applications.

An intuitive user interface will guide you to your complete data centre in five easy steps.



Android app



iPhone app

# Edge Data Center configurator



Rittal has developed a data centre for small and medium businesses which allows them to configure complete, turnkey "private cloud" solutions very easily.

The configurator is designed for IT solutions from 2 to 6 racks and an IT load of 3 to 30 kW, and includes both the analysis and configuration of rack, climate control, power supply and security components.

## Analysis

- Your data centre configuration in just a few steps
- Standardised solution
- CFD analyses for all configurations and load ranges
- Tested redundancy response

## Climate control

- Output range from 3 to 30 kW
- Cooling: LCU DX or LCP DX

## Power supply

- Power distribution: PDU, basic version 3 x 16 A (optional metered version)
- UPS: N+1 redundant ABB Upscale (optional)

## Security

- Monitoring: CMC III Processing Unit with temperature measurement and access control (optional)
- Automatic door opening (optional)
- Rack-based extinguisher system (optional)

The configurator is available at:  
[www.rittal.com/edgedatacenter](http://www.rittal.com/edgedatacenter)

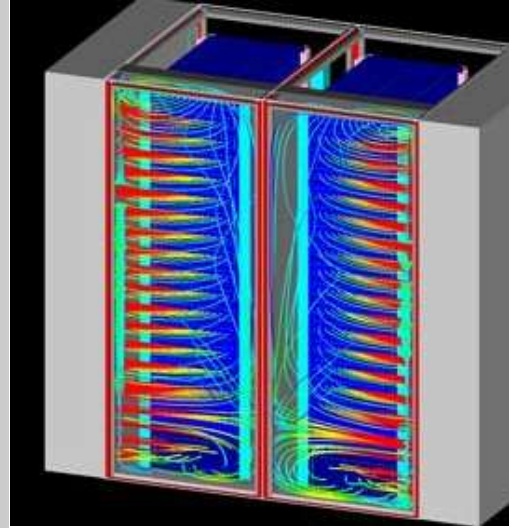

# RiMatrix S at a glance



## Standard room

Integration of RiMatrix S modules into an existing property.  
In order to achieve optimum air routing, precise-fit aisle containment is included with the supply.

Aisle containment is a combination of door and roof components which allow consistent separation of the hot and cold air.

- Enhanced energy efficiency
- Superior output density, due to guaranteed cold air supply
- Contact hazard protection and protection against the ingress of solid foreign bodies in the protected area above the raised floor IP 20 to IEC 60 529

	Single 6	Double 6	Single 9	Double 9	
<b>Model No.</b>	<b>7998.106</b>	<b>7998.107</b>	<b>7998.406</b>	<b>7998.407</b>	
Fire protection	-	-	-	-	
Burglar resistance	-	-	-	-	
Acrid gas-tightness	-	-	-	-	
Dust- and water-tightness	-	-	-	-	
Early fire detection	■	■	■	■	
Room extinguisher system	optional	optional	optional	optional	
Humidification and dehumidification system	optional	optional	optional	optional	
Efficiency package	<b>7998.905</b>	<b>7998.906</b>	<b>7998.907</b>	<b>7998.908</b>	
<b>External dimensions</b>					
<b>Width</b> mm	2807	4839	2807	4839	
<b>Height</b> mm	2750	2750	2750	2750	
<b>Depth</b> mm	7067	7070	7067	7070	
<b>Rack configuration</b>					
<b>Server enclosure (600 x 2000 x 1200 mm)</b>	6 pc(s).	12 pc(s).	8 pc(s).	16 pc(s).	
<b>Combined network-server enclosure (800 x 2000 x 1200 mm)</b>	1 pc(s).	2 pc(s).	1 pc(s).	2 pc(s).	
<b>Uninterruptible power supply (partner product)</b>	60 kW + 20 kW	2 x (60 kW + 20 kW)	-	-	

# RiMatrix S at a glance



## Security rooms

## Container

### Standard security room

- Fire protection category EI 90 to EN 1363/F90 to DIN 4102
- Protection against external access – Resistance class II to DIN V ENV 1630
- Basic EMC protection
- Acid gas-tightness based on DIN 18 095
- Shock test with 3,000 Nm energy after 30 minutes flame impingement over standard temperature curve
- Dust- and water-tight to IP 56 to IEC 60 529

### Construction of the standard security room

- Element core made from thermally effective insulating material
- Robust, encapsulated sheet steel cassette panels
- Innovative connection system using patented profile technology
- Use of temperature- and humidity-resistant seals
- Use of climate control valves with electro-magnetic drive
- Dismantling and reassembly are possible at any time

### Standard container

Robust sheet steel container specifically designed for IT applications. The reinforced frame structure allows optimum weight distribution. Encapsulated interior wall structure with thermal insulating materials.

- Vandal-proof interior to Resistance Class II to DIN EN 1630
- Basic EMC protection
- Dust- and water-tight IP 55 to IEC 60 529

	Security rooms		Container			
	Single 6	Double 6	Single 9	Double 9	Single 6	Single 9
	<b>7998.306</b>	<b>7998.307</b>	<b>7998.606</b>	<b>7998.607</b>	<b>7998.206</b>	<b>7998.506</b>
	EI 90/F90	EI 90/F90	EI 90/F90	EI 90/F90	–	–
	WK II	WK II	WK II	WK II	RC II	RC II
	■	■	■	■	–	–
	IP 56	IP 56	IP 56	IP 56	IP 55	IP 55
	■	■	■	■	■	■
	optional	optional	optional	optional	optional	optional
	optional	optional	optional	optional	optional	optional
	<b>7998.905</b>	<b>7998.906</b>	<b>7998.907</b>	<b>7998.908</b>	<b>7998.905</b>	<b>7998.907</b>
	2950	4976	2950	4976	3000	3000
	2800	2800	2800	2800	3000	3000
	7420	7420	7420	7420	7250	7250
	6 pc(s).	12 pc(s).	8 pc(s).	16 pc(s).	6 pc(s).	8 pc(s).
	1 pc(s).	2 pc(s).	1 pc(s).	2 pc(s).	1 pc(s).	1 pc(s).
	60 kW + 20 kW	2 x (60 kW + 20 kW)	–	–	60 kW + 20 kW	–

# Rittal – The System.

Faster – better – everywhere.

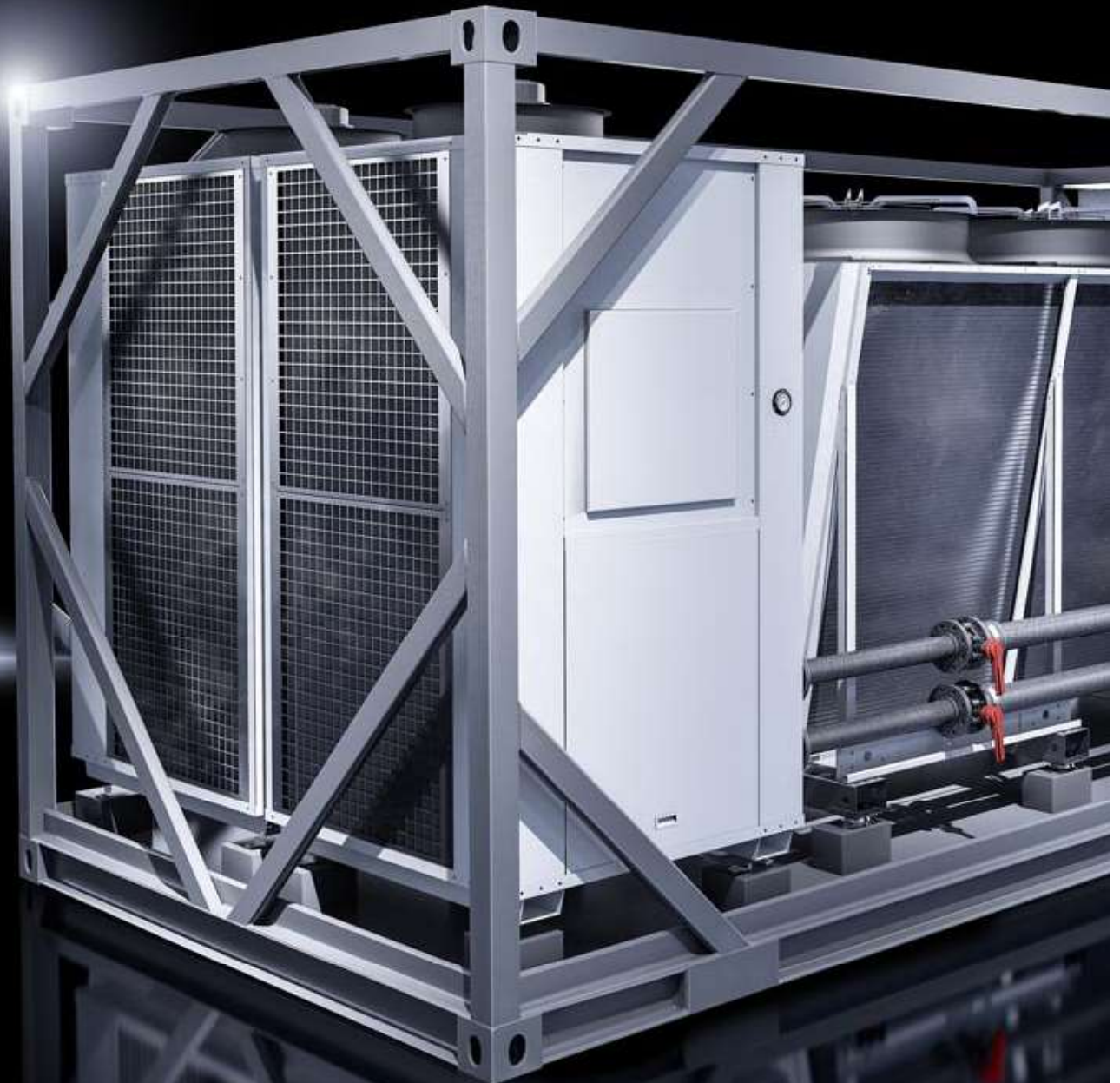

ENCLOSURES

POWER DISTRIBUTION

CLIMATE CONTROL

FRIEDHELM LOH GROUP

# Turn the right cooling solution into a complete system

The RiMatrix S cooling station allows a data centre module to be connected to a cold water supply using the plug & play compatibility system. The cooling station is installed in a 20 ft high Cube container frame, and comprises the following components:

- Free cooler with EC fans
- Chiller, 1+1 redundant
- Hydraulic station with pumps and controller
- Pipework

#### **Benefits of the plug & play solution:**

- Co-ordinated system for fast commissioning
- System-tested software to control all components, including emergency mechanisms
- Integral control with TCP/IP interface
- Power-saving cooling with a high inlet temperature and extensive use of free cooling
- Overarching control system with maximum efficiency class and low PUE



IT INFRASTRUCTURE

SOFTWARE & SERVICES



# RiMatrix S



The standardised data centre is assembled at your premises within the context of hot aisle / cold aisle containment.

#### Benefits:

- Enhanced energy efficiency
- Aisle containment is a combination of door and roof components which allow consistent separation of the hot and cold air

#### Protection category IP to IEC 60 529:

- IP 20 in the protected area above the raised floor

#### Supply includes:

- Advice and ROI calculation
- Delivery and integration into the customer infrastructure
- Commissioning and handover
- Documentation, training and instruction
- Hotline and service/service agreements
- Precise-fit aisle containment

Photo shows a configuration example with equipment not included in the scope of supply

## Standard room

Design	Packs of	Single 6	Double 6	Single 9	Double 9	Page
External dimensions, width mm		2807	4839	2807	4839	
External dimensions, height mm		2750	2750	2750	2750	
External dimensions, depth mm		7067	7070	7067	7070	
Interior dimensions, width mm		2750	4774	2750	4774	
Interior dimensions, height mm		2722	2722	2722	2722	
Interior dimensions, depth mm		7000	7000	7000	7000	
<b>Model No.</b>	1 pc(s).	<b>7998.106</b>	<b>7998.107</b>	<b>7998.406</b>	<b>7998.407</b>	
Early fire detection		■	■	■	■	
Room extinguisher system		optional	optional	optional	optional	
Humidification and dehumidification system		optional	optional	optional	optional	
Server rack (600 x 2000 x 1200 mm)		6	12	8	16	
Combined network/server rack (800 x 2000 x 1200 mm)		1	2	1	2	
Uninterruptible power supply		60 kW + 20 kW n+1 redundant	2 x (60 kW + 20 kW) n+1 redundant	–	–	
Low-voltage main distributor		1	2	1	2	
PDU Basic		14	28	18	36	
Climate control (ZUCS)		60 kW + 10 kW n+1 redundant	120 kW + 20 kW n+2 redundant	90 kW + 10 kW n+1 redundant	180 kW + 20 kW n+2 redundant	





The standardised data centre at your premises is equipped with an additional security room (room-within-a-room) to provide additional protection from fire, water and smoke.

**Protection standards:**

- Fire resistance EI 90 to EN 1363/F 90 to DIN 4102
- Dust- and watertight IP 56 to IEC 60 529
- Protection from unauthorised access – Resistance class II
- EMC basic protection
- Acid gas-tightness, based on EN 1634-3 (DIN 18095)
- Shock test with 3000 Nm energy after 30 minutes flame impingement over standard temperature curve

**Material:**

- Element core made of thermally effective insulation substance
- Robust, encapsulated sheet steel cassette panels
- Innovative connection technology using patented profile technology
- Use of temperature- and humidity-resistant seals
- Use of fire protection valves
- Dismantling and reassembly is possible at any time

**Supply includes:**

- Advice and ROI calculation
- Delivery and integration into the customer infrastructure
- Commissioning and handover
- Documentation, training and instruction
- Hotline and service/service agreements

Photo shows a configuration example with equipment not included in the scope of supply

## Standard security room

Design	Packs of	Single 6	Double 6	Single 9	Double 9	Page
External dimensions, width mm		2950	4976	2950	4976	
External dimensions, height mm		2800	2800	2800	2800	
External dimensions, depth mm		7420	7420	7420	7420	
Interior dimensions, width mm		2750	4776	2750	4776	
Interior dimensions, height mm		2700	2700	2700	2700	
Interior dimensions, depth mm		7220	7220	7220	7220	
<b>Model No.</b>	1 pc(s).	<b>7998.306</b>	<b>7998.307</b>	<b>7998.606</b>	<b>7998.607</b>	
Fire protection		EI 90 to EN 1363 / F 90 to DIN 4102	EI 90 to EN 1363 / F 90 to DIN 4102	EI 90 to EN 1363 / F 90 to DIN 4102	EI 90 to EN 1363 / F 90 to DIN 4102	
Burglar resistance		WK II	WK II	WK II	WK II	
Early fire detection		■	■	■	■	
Room extinguisher system		optional	optional	optional	optional	
Humidification and dehumidification system		optional	optional	optional	optional	
Server rack (600 x 2000 x 1200 mm)		6	12	8	16	
Combined network/server rack (800 x 2000 x 1200 mm)		1	2	1	2	
Uninterruptible power supply		60 kW + 20 kW n+1 redundant	2 x (60 kW + 20 kW) n+1 redundant	-	-	
Low-voltage main distributor		1	2	1	2	
PDU Basic		14	28	18	36	
Climate control (ZUCS)		60 kW + 10 kW n+1 redundant	120 kW + 20 kW n+2 redundant	90 kW + 10 kW n+1 redundant	180 kW + 20 kW n+2 redundant	

# RiMatrix S



The standardised data centre is implemented in a container solution and can therefore be sited outdoors if required.

#### Protection standards:

- Vandal-proof interior in accordance with Resistance Class II to DIN EN 1631
- EMC basic protection
- Dust- and watertight to IP 55 to IEC 60 529

#### Supply includes:

- Robust sheet steel container with reinforced frame structure for optimum weight distribution
- Housed interior wall structure with thermal insulating materials
- Advice and ROI calculation
- Delivery and integration into the customer infrastructure
- Documentation, training and instruction
- Hotline and service/service agreements

Photo shows a configuration example with equipment not included in the scope of supply

## Standard container

Design	Packs of	Single 6	Single 9	Page
External dimensions, width mm		3000	3000	
External dimensions, height mm		3000	3000	
External dimensions, depth mm		7250	7250	
Interior dimensions, width mm		2750	2750	
Interior dimensions, height mm		2700	2700	
Interior dimensions, depth mm		7000	7000	
<b>Model No.</b>	1 pc(s).	<b>7998.206</b>	<b>7998.506</b>	
Early fire detection		■	■	
Room extinguisher system		optional	optional	
Humidification and dehumidification system		optional	optional	
Server rack (600 x 2000 x 1200 mm)		6	8	
Combined network/server rack (800 x 2000 x 1200 mm)		1	1	
Uninterruptible power supply		60 kW + 20 kW n+1 redundant	-	
Low-voltage main distributor		1	1	
PDU Basic		14	18	
Climate control (ZUCS)		60 kW + 10 kW n+1 redundant	90 kW + 10 kW n+1 redundant	

# Data Centre Container



## System accessories Page 613

### Fire protection:

- Fire protection, internal panels: F30, optionally F90 based on DIN 4102/EN1363, component-tested

### Duct system:

- Type: Hard duct DN200
- Dimensions of packing space: 120 x 120 mm
- Protected cable/tube entries

### Raised floor:

- Optimised load distribution
- Equipped with cable/tube routing
- Variable ventilation panels with DFC

### Climate control:

- Customised climate control variants
- Targeted cooling via aisle containment
- Energy-efficient DFC cooling (direct free cooling), with no additional external units
- Powerful LCP cooling (liquid cooling package), with minimal space requirements

### Power distribution:

- Infeed: CEE connector 125 A, 3-phase/N/PE, 400 V/50 Hz
- Busbar system for rack-based power distribution

### Customised solutions:

- Interlinked containers, other climate control variants

### Optional:

- Fire alarm/extinguisher system (Novec 1230)
- Access systems, access door (keyboard, code card)
- Monitoring and management (CMC, RiZone) for monitoring alarm, maintenance messages and customer-specific parameters

### Note:

- Standard range of models with pre-configured data centre types
- The data centre container is configured on a project-specific basis

Photo shows a configuration example with equipment not included in the scope of supply

Type	1	2	3	4	5	6	7	8	9
<b>Width</b> mm	3000								
<b>Height</b> mm	3250								
<b>Depth</b> mm	6058	8000	10000	11500	6058	8000	10000	11500	9500
Useful area m <sup>2</sup>	15.2	20.4	25.7	29.7	15.2	20.4	25.7	29.7	20.4
<b>Model No.</b>	<b>7857.998</b>								
Climate control, Direct Free Cooling/Liquid Cooling Packages	DFC	DFC	DFC	DFC	LCP	LCP	LCP	LCP	LCP
<b>Max. cooling output</b> kW	<b>20</b>	<b>20</b>	<b>50</b>	<b>50</b>	<b>20</b>	<b>40</b>	<b>80</b>	<b>100</b>	<b>40</b>
Redundancy cooling	n+1	n+1	n+1	n+1	n+1	n+1	n+1	n+1	n+1
Heavy-duty raised floor	■	■	■	■	■	■	■	■	■
Plug-and-play power distribution	■	■	■	■	■	■	■	■	■
Hard ducts DN200	3	3	4	4	4	5	5	5	5
Security door, resistance class 2	■	■	■	■	■	■	■	■	■
<b>Optional fittings</b>									
DET-AC XL fire alarm/extinguisher system	■	■	■	■	□	□	□	□	□
UPS (uninterruptible power supply)	□	□	□	□	□	□	□	□	□
Max. no. of racks 42 U (600 mm wide) without UPS	6	9	10	12	6	8	11	13	8
Max. no. of racks 42 U (800 mm wide) without UPS	4	6	7	9	4	6	8	9	6
Higher racks (47 U)	□	□	□	□	□	□	□	□	□
Rack power supply	□	□	□	□	□	□	□	□	□
Monitoring package (CMC III)	□	□	□	□	□	□	□	□	□
RiZone package	□	□	□	□	□	□	□	□	□
Security door, resistance class 3	□	□	□	□	□	□	□	□	□
Additional hard ducts for cable/pipe entry	□	□	□	□	□	□	□	□	□
Metal sun protection	□	□	□	□	□	□	□	□	□

■ Standard □ Option

# Rittal – The System.

Faster – better – everywhere.



ENCLOSURES

POWER DISTRIBUTION

CLIMATE CONTROL

FRIEDHELM LOH GROUP

# IT as a service – Simplify your IT

Rittal and iNNOVO Cloud GmbH have joined forces in a strategic partnership to market new infrastructure and cloud solutions. These are marketed flexibly based on the “IT as a service” model (ITaaS). The services are based on the jointly developed RiMatrix BCC (Balanced Cloud Center) platform, using Rittal containers or in-house solutions.

Customers get a turnkey cloud data centre in which components such as racks, climate control and power supply are available as predefined modules. The scope of supply optionally includes the server, network and storage. In addition, the established open source “OpenStack” framework is used as cloud management software. The result is a standardised, “virtual private” cloud data centre, suitable for standard applications in the ITaaS, as well as for highly demanding ones, such as high-performance computing (HPC), SAP Hana or “big data” applications.

Customers can choose to either buy a modular cloud data centre in its entirety, or to rent it (data centre as a service). Application areas include, in particular, the Industry 4.0 segment and the Internet of Things (IoT) requiring a certain degree of latency between computing systems and production, known as “edge data centres”. Container-based data centres are also used for applications requiring a high level of scaling, as well as those with a high power density and efficiency.

For example, the BCC concept is being used in the Lefdal Mine Datacenter project. Both partners are still working on the development of a cloud park in Frankfurt, where Rittal BCC containers with an output of 200 kW each, equipped with hardware, are being installed. This offer is relevant for companies requiring powerful IT systems and who must source their cloud performance from a data centre located in Germany, for whatever reason.



IT INFRASTRUCTURE

SOFTWARE & SERVICES



# Rittal – The System.

Faster – better – everywhere.



“In today’s world, data is the new raw material, and I can’t imagine a better place to store it than at Lefdal.”

**Arne Norheim, Country General Manager, IBM**



ENCLOSURES

POWER DISTRIBUTION

CLIMATE CONTROL

FRIEDHELM LOH GROUP

# The future of IT is underground

On the west coast of Norway, one of the world's largest data centres is being built in a decommissioned mine at the Lefdal Mine Datacenter (LMD). The five-storey tunnel system with 75 chambers provides 120,000 square metres of space for an infrastructure with a potential total capacity of 200 MW. The ambitious target is to make the LMD the number one in Europe, with unsurpassed levels of cost-efficiency, security, flexibility and sustainability.

“The Lefdal Mine Datacenter will put everything else in the shade”, claims Andreas Keiger, Senior Vice President, European Sales at Rittal. Rittal is on board as a strategic technology partner. This project is setting new standards, not only in terms of efficiency, but also in the area of sustainability. Lefdal uses 100 percent renewable energies. Even the server cooling is “green”, by drawing on the water in the neighbouring fjord.

And when you consider the Total Costs of Ownership (TCO), the LMD is 40 percent cheaper than other data centres in Europe. This is partly due to standardised RiMatrix S data centre modules from Rittal, which score highly in terms of flexibility and cost efficiency. The preconfigured, space-saving modules are supplied in containers and comprise ten or twelve server racks. These are ready to use, complete with power distribution, climate control, and monitoring and IT infrastructure management software. The cooling solution is a Liquid Cooling Package. An LCP draws in waste air from the server, and cools it via the high-performance heat exchangers linked to the cold seawater circuit. EC fans blast the cool air in front of the IT equipment again. The entire system is connected to the 565 metre deep fjord, guaranteeing an unlimited supply of cold water, and reducing energy consumption to a minimum.

The underground data centre also has another inestimable benefit: Security! The system can only be accessed via one, well-protected entry point. The rock formation provides natural protection from electromagnetic pulses. Specially trained security staff patrol the entire installation around the clock, 365 days a year. A three-stage authentication process and intelligent camera systems provide additional security.

IT INFRASTRUCTURE

SOFTWARE & SERVICES

