



MICS3-CCAZ55PZ1P01

microScan3

SAFETY LASER SCANNERS

SICK
Sensor Intelligence.



Illustration may differ



Ordering information

Type	Part no.
MICS3-CCAZ55PZ1P01	1100392

The system plug is pre-assembled on the underside. It can either be mounted on the rear side or the underside.

Other models and accessories → www.sick.com/microScan3

Detailed technical data

Features

Protective field range	5.5 m
Warning field range	40 m
Number of simultaneously monitored fields	≤ 8 ¹⁾
Number of fields	128
Number of monitoring cases	128
Scanning angle	275°
Resolution (can be configured)	30 mm 40 mm 50 mm 70 mm 150 mm 200 mm
Angular resolution	0.39°
Response time	≥ 95 ms
Protective field supplement	65 mm

¹⁾ Protection, warning or contour detection fields.

Safety-related parameters

Type	Type 3 (IEC 61496)
Safety integrity level	SIL2 (IEC 61508) SILCL2 (EN 62061)
Category	Category 3 (EN ISO 13849)
Performance level	PL d (EN ISO 13849)
PFH_D (mean probability of a dangerous failure per hour)	8.0 x 10 ⁻⁸ (EN ISO 13849)

T_M (mission time)	20 years (EN ISO 13849)
Safe state in the event of a fault	The safety outputs via the network are logic 0.

Functions

Restart interlock	✓
Multiple sampling	✓
Monitoring case switching	✓
Simultaneous monitoring	✓
Static protective field switching	✓
Safe contour detection	✓
Contour as a reference	✓
Integrated configuration memory	✓
Measured data output	Via Ethernet

Interfaces

Connection type	
Voltage supply	1 x male connector, M12, 5-pin, L-coded
Fieldbus, industrial network	2 x female connector, RJ45 for push-pull male connector (copper)
Outputs	
OSSD pairs	0
Safety outputs via network	8
Configuration method	PC with Safety Designer (Configuration and Diagnostic Software)
Configuration and diagnostics interface	USB 2.0, Mini-USB, Ethernet
Fieldbus, industrial network	PROFINET
Protocol	PROFIsafe
Supported protocol versions	PROFINET specification V2.3 PROFIsafe profile in accordance with specification V2.6.1 PROFIsafe profile in accordance with specification V2.4
GSDML	According to GSDML specification V2.33
Cycle time	1 ms, 2 ms, 4 ms, 8 ms, 16 ms ...
Conformance	Conformance Class C
Network management	SNMP MIB-2 LLDP in accordance with IEEE 802.1AB MRP client support
Net load	Net load class III in accordance with security level 1 test
Switch properties	2 port real-time switch compliant with IEEE 802
Port properties	100Base-TX Auto-negotiation Auto-crossover (MDIX) Auto-polarity
Diagnostics	I&M data sets 0 ... 5 PROFINET alarms
Additional services	PROFInergy F_iPar_CRC Acyclic read-/write services for communication via TCI
Additional interfaces	TCP/IP communication via port 9000
Display elements	Graphic color display, LEDs

Electrical data

Protection class	III (EN 61140)
Supply voltage V_s	24 V DC (16.8 V DC ... 30 V DC)
Power consumption	7 W (without output load)

Mechanical data

Dimensions (W x H x D)	112 mm x 163.1 mm x 111.1 mm (without system plug)
Weight	1.65 kg
Housing material	Aluminum
Housing color	RAL 1021 (yellow), RAL 9005 (black)
Optics cover material	Polycarbonate
Optics cover surface finish	Outside with scratch-resistant coating

Ambient data

Enclosure rating	IP65 (IEC 60529)
Ambient light immunity	$\leq 3,000$ lx (IEC 61496-3)
Ambient operating temperature	-10 °C ... +50 °C
Storage temperature	-25 °C ... +70 °C
Vibration resistance	0.35 mm, 10 Hz ... 60 Hz (IEC 60068-2-6, IEC 61496-1, IEC 61496-3) 5 g, 60 Hz ... 150 Hz (IEC 60068-2-6, IEC 61496-1, IEC 61496-3)
Shock resistance	
Continuous shock	10 g, 16 ms (IEC 60068-2-27, IEC 61496-3)
EMC	IEC 61496-1 IEC 61000-6-2 IEC 61000-6-4

Other information

Type of light	Pulsed laser diode
Wave length	845 nm
Detectable remission	1.8% to several 1000%
Laser class	1M (21 CFR 1040.10 and 1040.11, IEC 60825-1)

Classifications

ECl@ss 5.0	27272705
ECl@ss 5.1.4	27272705
ECl@ss 6.0	27272705
ECl@ss 6.2	27272705
ECl@ss 7.0	27272705
ECl@ss 8.0	27272705
ECl@ss 8.1	27272705
ECl@ss 9.0	27272705
ECl@ss 10.0	27272705
ECl@ss 11.0	27272705
ETIM 5.0	EC002550
ETIM 6.0	EC002550
ETIM 7.0	EC002550

UNSPSC 16.0901

39121528

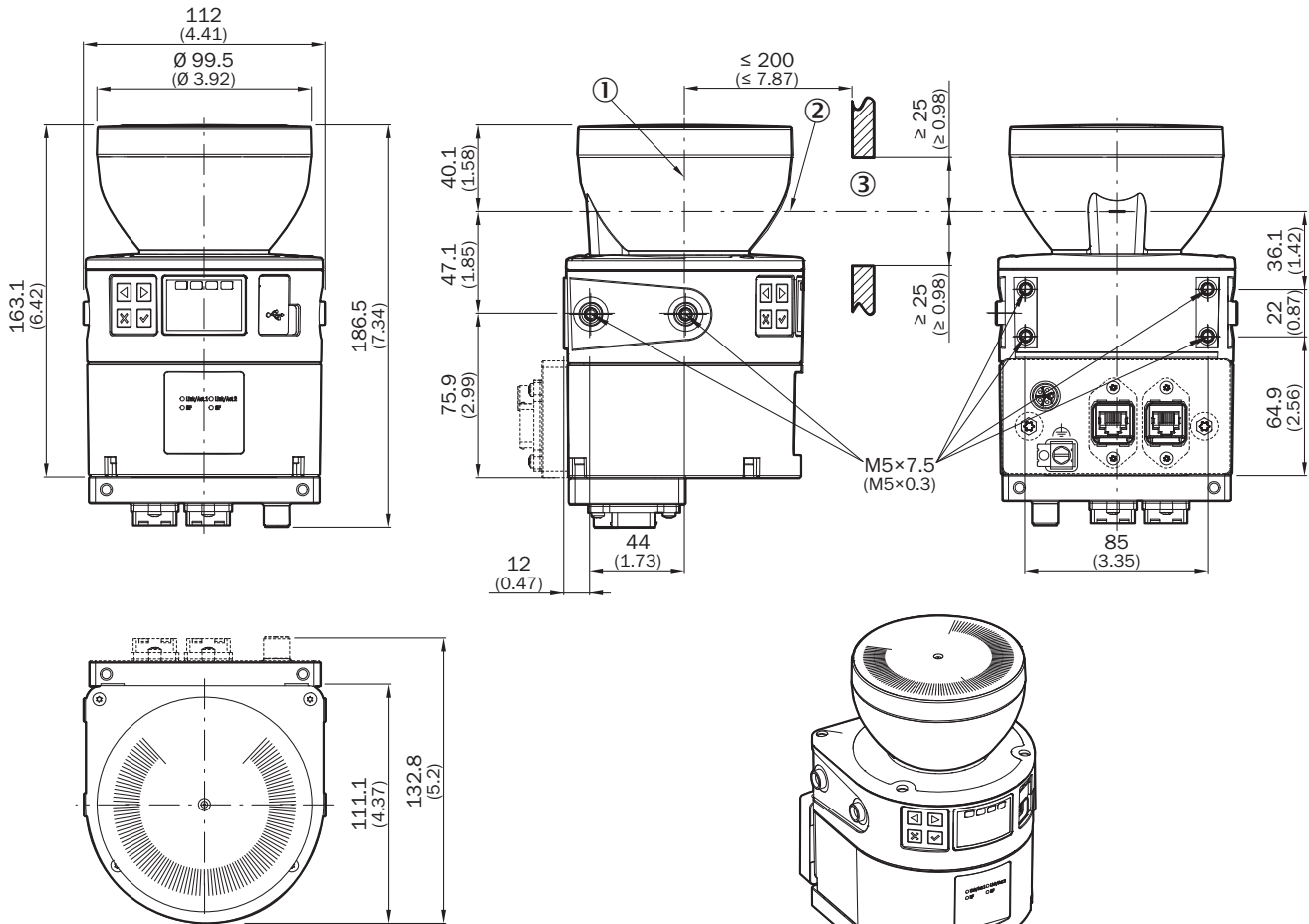

Dimensional drawing (Dimensions in mm (inch))









- ① Mirror axis of rotation
- ② Scan plane
- ③ Required viewing slit

Recommended accessories

Other models and accessories → www.sick.com/microScan3

	Brief description	Type	Part no.
Mounting brackets and plates			
	1 piece, mounting bracket, heavy-duty version, with protection cover, for floor mounting, height adjustment possible from 90 ... 310 mm, scanner tilt angle: ± 5°. Additional mounting brackets are not required., steel, painted (RAL 1021)	Heavy-duty mounting kit for floor mounting	2102289
	1 piece, mounting bracket 150 mm for floor mounting of microScan3, stainless steel, Bracket and 4 x M5 screws for attaching the microScan3	Mounting bracket 150 mm for floor mounting of microScan3	2112950

	Brief description	Type	Part no.
	1 piece, mounting bracket 300 mm for floor mounting of microScan3, stainless steel, Bracket and 4 x M5 screws for attaching the microScan3	Mounting bracket 300 mm for floor mounting of microScan3	2112951
	1 piece, mounting bracket	Mounting kit 1a	2073851
	1 piece, mounting bracket with protection of optics hood	Mounting kit 1b	2074242
	1 piece, alignment bracket, alignment with cross-wise axis and depth axis possible, distance between mounting surface and device: 22.3 mm, only in conjunction with mounting kit 1a (2073851) or 1b (2074242)	Mounting kit 2a	2073852
	1 piece, Alignment bracket, alignment with cross-wise axis and depth axis possible, distance between mounting surface and device: 52.3 mm, only in conjunction with mounting kit 1a (2073851) or 1b (2074242)	Mounting kit 2b	2074184
Plug connectors and cables			
	Head A: female connector, M12, 5-pin, straight, L-coded Head B: Flying leads Cable: Sensor/actuator cable, PUR, halogen-free, unshielded, 2 m	YF2L15-020UH1XLEAX	2099599
	Head A: female connector, M12, 5-pin, straight, L-coded Head B: Flying leads Cable: Sensor/actuator cable, PUR, halogen-free, unshielded, 5 m	YF2L15-050UH1XLEAX	2099626
	Head A: female connector, M12, 5-pin, straight, L-coded Head B: Flying leads Cable: Sensor/actuator cable, PUR, halogen-free, unshielded, 10 m	YF2L15-100UH1XLEAX	2099627
	Head A: female connector, M12, 5-pin, straight, L-coded Head B: Flying leads Cable: Sensor/actuator cable, PUR, halogen-free, unshielded, 20 m	YF2L15-200UH1XLEAX	2099628
	Head A: Push-pull male connector, M12, L-coded	Push-pull adapter	2098095
			

SICK AT A GLANCE

SICK is one of the leading manufacturers of intelligent sensors and sensor solutions for industrial applications. A unique range of products and services creates the perfect basis for controlling processes securely and efficiently, protecting individuals from accidents and preventing damage to the environment.

We have extensive experience in a wide range of industries and understand their processes and requirements. With intelligent sensors, we can deliver exactly what our customers need. In application centers in Europe, Asia and North America, system solutions are tested and optimized in accordance with customer specifications. All this makes us a reliable supplier and development partner.

Comprehensive services complete our offering: SICK LifeTime Services provide support throughout the machine life cycle and ensure safety and productivity.

For us, that is “Sensor Intelligence.”

WORLDWIDE PRESENCE:

Contacts and other locations –www.sick.com