

Contents

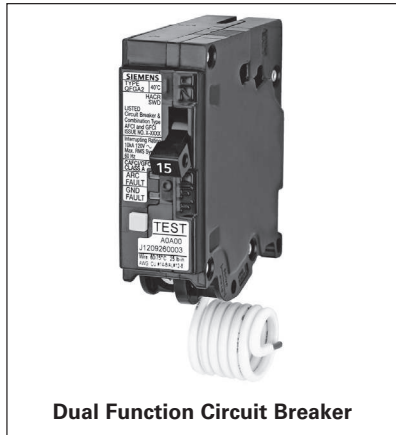

Dual Function Circuit Breaker

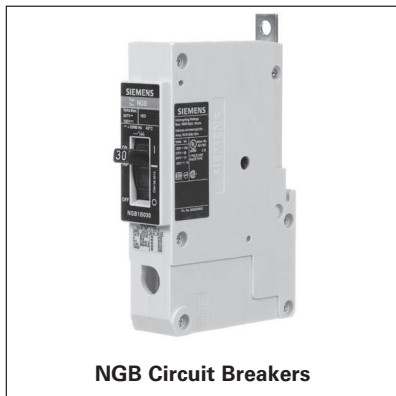

NGB Circuit Breakers

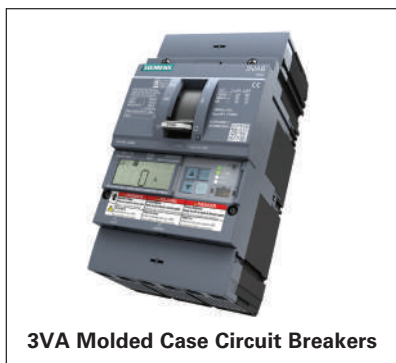

3VA Molded Case Circuit Breakers

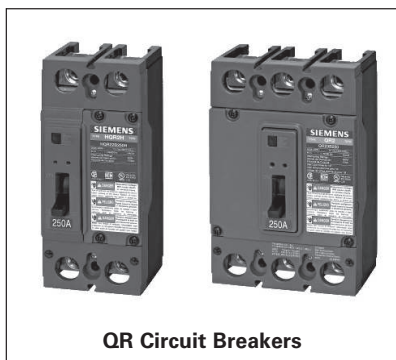

QR Circuit Breakers

What's New in Circuit Breakers	5-3
Introduction	5-4
Catalogue Numbering System	5-5 – 5-7
Reference Guides	5-8 – 5-19
Panelboard Mounted Circuit Breakers	
BL 240V Arc Fault and Ground Fault Breakers	5-20
BL 240V Breakers	5-21
BQD 100A Frame 480/277V Breakers	5-22
GB2 125A Frame 600/347V Breakers	5-23
GB 125A Frame 600/347V Breakers	5-24
Internal Accessories for BQD and NGB Breakers	5-25
3VA41 125A Frame 600/347V Breakers	5-26 – 5-27
General Application Circuit Breakers	
BQ 240V Breakers	5-28
BQXD 240V DIN Rail Mounting Breakers	5-29
QR250 Frame 240V Breakers	5-30
CQD 100A Frame 480/277V Breakers	5-31
GG 125A Frame 600/347V Breakers	5-32
Internal Accessories for CQD and NGG Breakers	5-33
3VA Molded Case Circuit Breakers	
Catalog Numbering System	5-34 – 5-35
3VA51 125A Thermal-magnetic Trip Circuit Breakers	5-36 – 5-39
3VA61 150A Electronic Trip Circuit Breakers	5-40 – 5-43
3VA52 250A Thermal-magnetic Trip Circuit Breakers	5-44 – 5-47
3VA62 250A Electronic Trip Circuit Breakers	5-48 – 5-51
3VA53 400A Thermal-magnetic Trip Circuit Breakers	5-52 – 5-53
3VA63 400A Electronic Trip Circuit Breakers	5-54 – 5-57
3VA54 600A Thermal-magnetic Trip Circuit Breakers	5-58 – 5-59
3VA64 600A Electronic Trip Circuit Breakers	5-60 – 5-63
3VA55 800A Thermal-magnetic Trip Circuit Breakers	5-64
3VA65 800A Electronic Trip Circuit Breakers	5-65 – 5-67
3VA66 1000A Electronic Trip Circuit Breakers	5-68 – 5-69
3VA Molded Case Switch and Motor Circuit Protector	5-70 – 5-71
3VA Internal Accessories	5-72
3VA Breaker Operators	5-73 – 5-78
3VA Connection Technology	5-79 – 5-87
3VA Plug-in and Draw-out Technology	5-88 – 5-90
3VA Communication and Testing/Commissioning Devices	5-91 – 5-94
3VA Accessories and Electrical Requirements	5-95 – 5-100
Sentron Thermal Magnetic and Electronic Circuit Breakers	
ED 125A Frame 600V Breakers and Internal Accessories	5-101 – 5-103
FD 250A Frame 600V Breakers and Internal Accessories	5-104 – 5-106
JD/SJD 400A Frame Breakers and Internal Accessories	5-107 – 5-110
LD/SLD 600A Frame Breakers and Internal Accessories	5-111 – 5-114
LMD 800A Frame Breakers and Internal Accessories	5-115 – 5-117
MD/SMD 800A Frame Breakers and Internal Accessories	5-118 – 5-121
ND/SND 1200A Frame Breakers and Internal Accessories	5-122 – 5-125
PD/SPD 1600A Frame Breakers and Internal Accessories	5-126 – 5-128
RD 2000A Frame Breakers and Internal Accessories	5-129
Magnetic Trip Only – ETI Motor Circuit Protectors	5-130 – 5-132
Adjustable Instantaneous Magnetic Trip Settings	5-133 – 5-135
Molded Case Switch – Circuit Disconnect	5-136
Digital Solid State Sentron Sensitrip IV Series Trip Units	5-137 – 5-138
Enclosed Circuit Breakers	5-139 – 5-146

(continued on next page)

Contents

Lug Information	5-147 – 5-149
Breaker Modifications	5-150
Internal Accessories – Feature Combinations	5-151 – 5-153
External Accessories	5-154 – 5-159
Unusual Operating Conditions	5-160 – 5-161
VL Thermal Magnetic and Electronic Circuit Breakers	
Technical Overview	5-162 – 5-163
Trip Unit Overview	5-164 – 5-165
DG 150A Frame and Internal Accessories	5-166 – 5-169
FG 250A Frame and Internal Accessories	5-170 – 5-173
JG 400A Frame and Internal Accessories	5-174 – 5-177
LG 600A Frame and Internal Accessories	5-178 – 5-181
MG 800A Frame and Internal Accessories	5-182 – 5-185
NG 1200A Frame and Internal Accessories	5-186 – 5-189
PG 1600A Frame and Internal Accessories	5-190 – 5-192
Molded Case Switch	5-193
Motor Circuit Protector	5-194
External Accessories	5-195 – 5-209
Accessory Locations	5-211
Suffix for Factory Mounted Internal Accessories	5-212
Technical Data	5-213 – 5-214
Unusual Operating Conditions	5-215 – 5-216
General Technical	
Series Short Circuit Ratings	5-217 – 5-247
Sentron IEC 947-2 AC Interrupting Ratings	5-248
Typical Specifications	5-249
Superseded Circuit Breakers	5-250 – 5-252

Molded Case Circuit Breakers

Introduction

What's **NEW** in molded case circuit breakers:

New Sentron Sensitrip

Sentron Sensitrip IV ETU Circuit Breakers with Integrated DAS / Maintenance Mode

Design enhancements include:

- Upgraded ETU
- Frame ratings from 400A to 1600A
- Identical footprint, kAIC ratings and accessory offering as legacy Sensitrip III ETU breakers to ease integration / retrofit
- Maintenance mode versions require customer-supplied 24V external power supply, maintenance switch and light



The Siemens GG, and xGB2 circuit breaker is a compact, industrial design thermal magnetic breaker with valuable features for the global markets. These features include a design that meets multi-national standards, is suitable for DIN rail or base mounting without the need for adapters, and includes CSA Certified / UL Listed field installable accessories. The GG, and xGB2 also has an over center toggle mechanism that is trip free and uses repulsion contact arm construction. Therefore, should a short circuit or tripping condition occur, the contacts are forced apart and the breaker cannot be held closed by means of the handle.

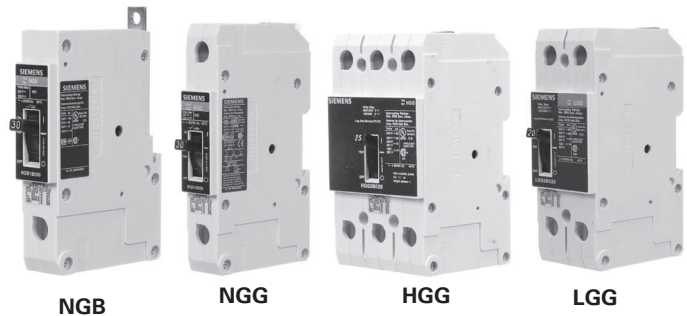

NGB

NGG

HGG

LGG

The New Siemens QR Circuit Breaker

Implemented in loadcentres, panelboards, switchboards, meter centres, and modular metering, the new QR breaker is the same form-factor/mounting as QJ breaker for easy retrofit.

Design enhancements include:

- Trip unit ratings from 100A to 250A.
- Field installable internal accessories – shunt trip, aux switch or shunt/aux combo.
- Two accessory pockets in 3-pole breakers. One accessory pocket in 2-pole breakers.
- High in-rush current capability (450%).
- Push-to-trip button.



The new Siemens 3VA Molded Case Circuit Breakers



- 125A - 800A Thermal-Magnetic Circuit Breakers
- 150A - 1000A Electronic Circuit Breakers
- Extensive and flexible accessories
- Common internal accessories for the entire breaker family
- Power metering with the series-8 LCD electronic trip
- Illuminated rotary handles show switch position
- Smaller footprint than Sentron or VL breakers
- Enhanced Tools and Resources

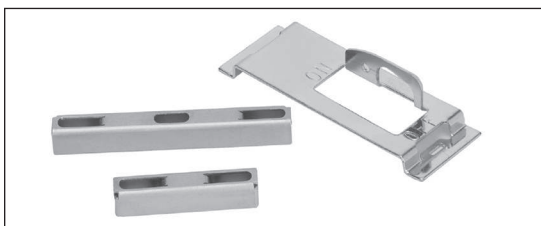

BOD and NGB, HGB, LGB handle ties are now released for use where single pole breakers are using shared neutrals and must be locked out simultaneously.

Molded Case Circuit Breakers

Introduction

Ordering

In the FD through RD frames, you may order molded case circuit breakers three basic ways:

1. As separately ordered frames, trip units and lugs
2. As frame, trip unit and lugs ordered as one catalog number and shipped unassembled or assembled
3. As Frame and Trip Unit shipped assembled and with the trip unit made non-removable, in compliance with UL 489 / CSA C22.2 No. 5 requirements that to be reverse fed the circuit breaker must not have an interchangeable trip unit.

These two options are described in the following:

Components Ordered Separately

To get the components for a 3-pole, 400 Amp standard interrupting circuit breaker, you would order the frame (JD63F400), the trip unit (JD63T400) and six lugs (TA2J6500). This option is normally useful only if you stock and use large volumes of product and wish to reduce your inventory cost. You may stock, for example, a smaller number of frames (JD63F400) and a variety of trip units (JD63T300, JD63T350, etc.) and assemble breakers as you need them.

Frame, Trip Unit and Lugs Ordered Together

If you order the catalog number JD63B400, you will receive a frame, a trip unit and 6 lugs in separate packages. By suffixing this number with "L" (e.g. JD63B400L), you will receive frame, trip unit and lugs assembled in one container. Pursuant to CSA C22.2 No. 5-13 / UL 489, a product ordered thus will have the markings "LINE" and "LOAD", and may not be "reverse fed" (with power flowing from the "OFF" end of the breaker toward the "ON" end).

Non-Interchangeable Trip Breakers

If you place an "X" after the frame size designator (e.g. JXD63B400), you will receive a frame and trip unit assembled, with the trip unit made non-removable. If you suffix an "L" to this catalog number (e.g. JXD63B400L), you will receive the breaker, non-removable trip unit and lugs assembled. Unless you anticipate a specific need to change the breaker's ampere rating in the future, this is the preferred ordering method, as the products are assembled to Siemens' specifications in our factories. These breakers are suitable for use reverse fed according to CSA C22.2 No. 5-13 / UL 489, since the trip unit is not removable.

The smaller frames (QJ, ED and below) do not have removable trip units, and consequently are shipped only as assembled products. To add lugs, see the ordering instructions on each product's catalog page.

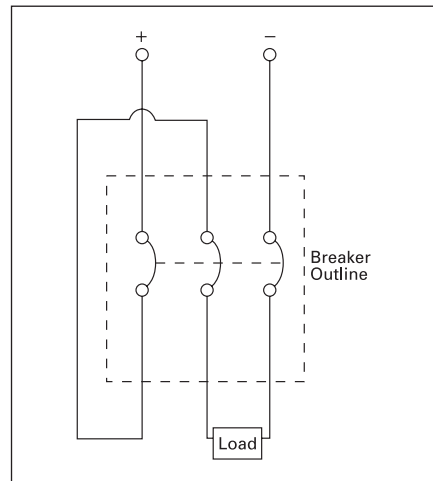

500V DC Wiring Configuration

Connecting Breakers for DC Application

Most Siemens thermal magnetic trip MCCBs are applicable on direct current (dc) systems. Generally, for 250 V dc systems a two pole breaker is used, with one pole on each leg of the supply circuit. For three pole breakers applied on 500 V undergrounded DC systems, it is important to connect the power supply "zig-zag" through the breaker as shown in the figure below. This assures that the Voltage between phases on the breaker terminals is uniformly distributed.

See below for an alternative connection diagram. For a list of Sentron breakers with the DC ratings, please refer to pages 5-8 - 5-19.

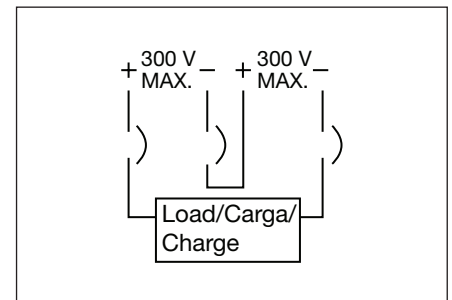

Molded Case Circuit Breakers

Catalogue Numbering System

Selection/Application

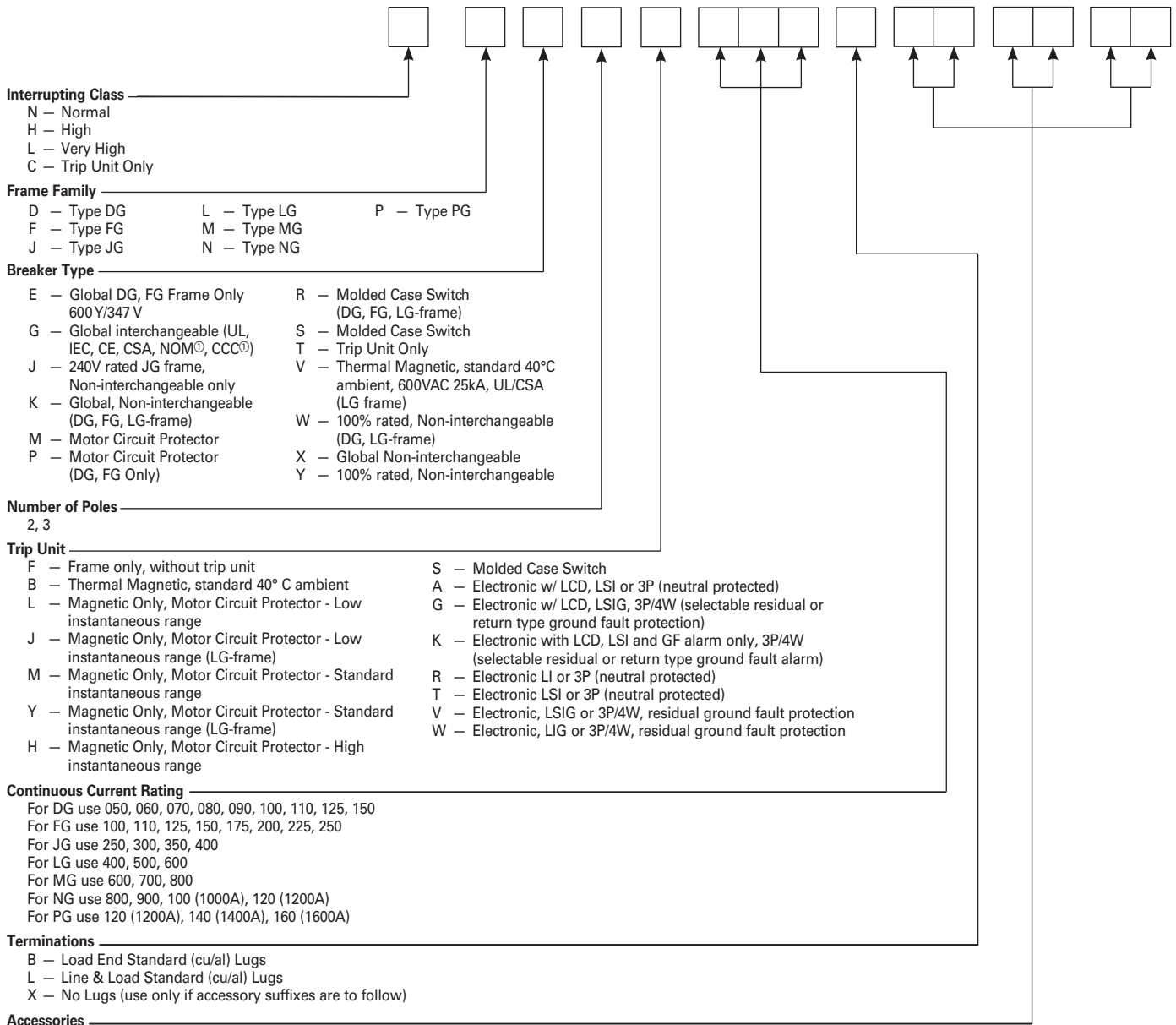

Accessories

Auxiliary and Alarm Switch Combinations

Suffix	Description
A1	1 Alarm (includes 1NO & 1NC switch with a 2 Aux./1 Alarm Base, for frames DG to LG)
A2	2 Aux (1NO & 1NC switch with a 3 Aux. Base, for frames DG to LG)
A3	2 Aux + 1 Alarm (2NO & 2NC switches with a 2 Aux./1 Alarm Base, for frames DG to LG)
A3	2 Aux + 2 Alarm (2NO & 2NC switches with a 2 Aux./2 Alarm Base, for frames MG to PG)
A4	4 Aux (2NO & 2NC switches with a 4 Aux. Base, for frames MG to PG)

Note: A1 and A3 include 1NO and 1NC switch for alarm purposes, only one of these switches may be used as there is only one space for an alarm.

Shunt Trips

RB – 24 VDC	RM – 48-60 VAC
RC – 48-60 VDC	RN – 110-127 VAC
RD – 110-127 VDC	RS – 208-277 VAC
RE – 250 VDC	RV – 380-600 VAC

Under Voltage Releases

UA – 12 VDC	UN – 110-127 VAC
UB – 24 VDC	UP – 208 VAC
UC – 48 VDC	UR – 220-250 VAC
UD – 110-127 VDC	US – 277 VAC
UE – 220-250 VDC	UT – 380-415 VAC
UG – 60 VDC	UU – 440-480 VAC
UK – 24 VAC	

LCD = Liquid Crystal Display
 LI = Long Delay & Instantaneous trip functions
 LSI = Long Delay, Short Delay, & Instantaneous trip functions
 LSIG = Long Delay, Short Delay, Instantaneous, & Ground Fault trip functions
 GF = Ground Fault
 3P = 3-pole
 4W = 4-wire

© Select Frames

VL Circuit Breakers

Catalogue Numbering System

Selection

If ordering factory-installed accessories or special modifications, you must order a 15-digit catalog number. See the examples below for a detailed explanation. The 15 digit number is achieved by placing X's in positions not being occupied by an accessory/modification. Contact Siemens for circuit breakers configured with accessories.

Auxiliary Switch Example:

H F G 3 B 2 0 0 L A 2 X X X X

Standard 9-digit Aux. Switch Completes Cat #

Shunt Trip / UVR Example:

H F G 3 B 2 0 0 L X X U N X X

Standard 9-digit UVR Completes Cat #

Shunt Trip / Auxiliary Switch Example:

H F G 3 B 2 0 0 L A 2 R N X X

Standard 9-digit Aux. Switch Shunt Trip Completes Cat #

Non-Interchangeable Trip Breakers Example:

H F X 3 B 2 0 0 L

Standard 9-digit

5

MOLDED CASE
CIRCUIT BREAKERS

Molded Case Circuit Breakers

Reference Guide

Selection/Application

Thermal-Magnetic Trip Breakers

Page	Plug-In Breakers							Panelboard Breakers								
	QT	QP	QPH	HQP	HQPPH	QPJ	BL [®]	BLH	HBL	BQD, BQD6	NGB, NGB2	HGB2	LGB2			
	Refer to Loadcentres Section							5-20	5-20	5-20	5-22	5-23 - 5-24	5-23	5-23		
	Poles	1, 2	1, 2, 3	1, 2, 3	1, 2, 3 ^②	2	2, 3	1,2,3	1,2,3	1,2,3	1,2,3	1,2,3	1,2,3	1,2,3		
	Amperes	15-50	10-125 ^{③④}	10-125 ^{③④}	10-125 ^{③②}	100-225	150-200	10-125	15-125	15-100	15-100	15-125	15-125	15-125		
Ratings	AC	Poles	1 Pole	120/240	120/240	120/240	120/240	120/240	120/240	120/240	120/240	277	347	347	347	
			2 Pole	—	240	240	240	240	240	240	240	240	480/277	600/347	600/347	600/347
			3 Pole	—	240	240	240	240	240	240	240	240	480/277	600/347	600/347	600/347
	Interrupt Ratings	CSA/UL	120V	10,000	10,000	22,000	65,000	—	—	10000	22000	65000	65000	—	—	—
			240V	10,000	10,000	22,000	65,000	100,000	10,000	10000	22000	65000	65000	100000	100000	100000
			277V	—	—	—	—	—	—	—	—	—	14000	—	—	—
			347V	—	—	—	—	—	—	—	—	—	10000	—	—	—
			480/277V	—	—	—	—	—	—	—	—	—	14000	25000	35000	65000
			480V	—	—	—	—	—	—	—	—	—	—	—	—	—
		600/347V	—	—	—	—	—	—	—	—	—	10000	14000	22000	25000	
		600V	—	—	—	—	—	—	—	—	—	—	—	—	—	
		IEC 947-2 50/60 Hz	220/240V	I _{cu}	—	—	—	—	—	—	—	—	—	—	—	—
				I _{cs}	—	—	—	—	—	—	—	—	—	—	—	—
			380/415V	I _{cu}	—	—	—	—	—	—	—	—	—	—	—	—
				I _{cs}	—	—	—	—	—	—	—	—	—	—	—	—
500V	I _{cu}		—	—	—	—	—	—	—	—	—	—	—	—		
	I _{cs}		—	—	—	—	—	—	—	—	—	—	—	—		
DC	125/250 V DC Interrupting Rating	2-Pole	—	—	—	—	—	—	—	—	14000	14000	14000	14000		
		3-Pole	—	—	—	—	—	—	—	—	—	—	—	—		
Dimensions in Inches	Height	10-50A	—	2.87	2.87	—	—	—	3.56	3.56	3.75	4.50	5.00	5.00	5.00	
		10-60A	3.12	—	—	—	—	—	—	—	—	—	—	—	—	
		55-125A	—	3.12	3.12	3.12	3.12	3 ^⑤	3.75	3.75	3.75	4.50	5.00	5.50	5.50	
	Width	1-Pole	1.00	1.00	1.00	1.00	—	—	1.00	1.00	1.00	1.00	1.00	1.00	1.00	
		2-Pole	2.00 ^①	2.00	2.00	2.00	4.00	⑥	2.00	2.00	2.00	2.00	2.00	2.00	2.00	
3-Pole		2.00 ^①	3.00	3.00	3.00	—	3.00 ^⑦	3.00	3.00	3.00	3.00	3.00	3.00	3.00		
Depth	2.06	2.37	2.37	2.37	2.37	2.34	2.37	2.37	2.37	2.69	2.71	2.71	2.71			
Overcurrent Devices	Thermal and Fixed magnetic Trip		√	√	√	√	√	√	√	√	√	√	√	√		
	Thermal and Adjustable Magnetic trip		—	—	—	—	—	—	—	—	—	—	—	—		
	Adjustable Magnetic trip only		—	—	—	—	—	—	—	—	—	—	—	—		
	Motor Circuit Protector		—	—	—	—	—	—	—	—	—	—	—	—		
	Molded Case Switch		—	√ ^⑧	—	—	—	—	—	—	—	—	—	—		
Accessories & Modifications	Undervoltage Trip		—	—	—	—	—	—	—	—	√	—	√	√		
	Shunt Trip		—	√ ^⑧	√ ^⑧	√	√ ^⑧	—	√	√	√	√	√	√		
	Auxiliary Switch		—	—	—	—	√ ^⑧	—	√	√	√	√	√	√		
	Alarm Switch		—	—	—	—	—	—	—	—	—	√	√	√		
	Mechanical Interlock		—	—	—	—	—	—	—	—	—	—	—	—		
Fungus Proofing (ref. page 5-160)		—	—	—	—	—	—	√	√	√	√	√	√			

5 MOLDED CASE CIRCUIT BREAKERS



For inches / millimeters conversion, see Technical section.
For Plug-in Breakers, see Loadcentres section.

① BQD6 CSA certified 10,000A @ 600Y/347V 15-70A only.
② Single pole circuit breakers available in ratings 15-70A only, 125A available as a 2-pole only.
③ 10A, 1-pole & 2-pole 120/240V AC only.
④ 125A, 2-pole 120/240V AC only.
⑤ Single pole circuit breakers available in ratings 15-70A only, 125A available as a 2-pole only.
⑥ 10A, 1-pole & 2-pole 120/240V AC only.

Molded Case Circuit Breakers

Reference Guide

Selection/Application

Thermal-Magnetic Trip Breakers

			General Purpose Breakers									
			BQ	BQH	HBQ	QR2	QRH2	HQR2	HQR2H	CQD	NGG	
Page			5-28	5-28	5-28	5-30	5-30	5-30	5-30	5-31	5-32	
Ratings	AC	Poles	1, 2, 3	1, 2, 3	1, 2, 3	2, 3	2, 3	2, 3	2, 3	1, 2, 3	1, 2, 3	
		Amperes, Continuous	1-Pole	15-70	15-70	15-50	—	—	—	—	15-100	15-125
			2-Pole	15-125	15-100	15-70	100-250	100-250	100-250	100-250	15-100	15-125
			3-Pole	15-100	15-100	15-100					15-100	15-125
		Volts (50/60 Hertz)	1-Pole	120/240	120/240	120/240	—	—	—	—	277	347
			2-Pole				240	240	240	240	480/277	600/347
			3-Pole	240	240	240	240	240	240	240	480/277	600/347
		CSA/UL Interrupting Rating – Symmetrical RMS Amperes	120V	10,000	22,000	65,000	—	—	—	—	65,000	65,000
			240V	10,000	22,000	65,000	10,000	25,000	65,000	100,000	65,000	65,000
	480V		—	—	—	—	—	—	—	14,000 ^①	25,000	
600/347V	—		—	—	—	—	—	—	10,000	14,000		
DC	Volts – 2-Pole	—	—	—	—	—	—	—	125/250	125/250		
	Interrupting Rating – DC Amperes	—	—	—	—	—	—	—	14,000	14,000		
Dimensions in Inches	Height	15-50A	3.75	3.75	4.00	—	—	—	—	4.50	5.40	
		55-125A	4.00	4.00	4.00	—	—	—	—	4.50	5.40	
		60-225A	—	—	—	7.00	7.00	7.00	7.00	—	—	
	Width	1-Pole	1.00	1.00	1.00	—	—	—	—	1.00	1.00	
		2-Pole	2.00	2.00	2.00	3.00	3.00	3.00	3.00	2.00	2.00	
3-Pole		3.00	3.00	3.00	4.50	4.50	4.50	4.50	3.00	3.00		
Depth		2.37	2.37	2.37	2.53	2.53	2.53	2.53	2.87	2.90		
Overcurrent Devices	Thermal and Fixed Magnetic Trip	✓	✓	✓	✓	✓	✓	✓	✓	✓		
	Molded Case Switch	✓	—	—	✓	—	—	✓ ^③	—	—		
Accessories & Modifications	Undervoltage Trip	—	—	—	—	—	—	—	—	—		
	Shunt Trip	✓	✓	✓	✓	✓	✓	✓	✓	✓		
	Auxiliary Switch	✓	✓	✓	✓	✓	✓	✓	✓	✓		
	Alarm Switch	—	—	—	—	—	—	—	✓	✓		
	Mechanical Interlock	—	—	—	✓	✓	✓	✓	—	—		
Fungus Proofing (ref. page 5-160)	✓	✓	✓	✓	✓	✓	✓	✓	✓			
Individual Enclosures	Type 1 – Indoor Surface	✓	✓	✓	—	—	—	—	—	—		
	Type 1 – Indoor, Flush	✓	✓	✓	—	—	—	—	—	—		
	Type 3R – Outdoor-Rainproof	✓	✓	✓	—	—	—	—	—	—		

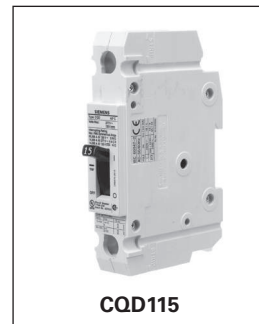
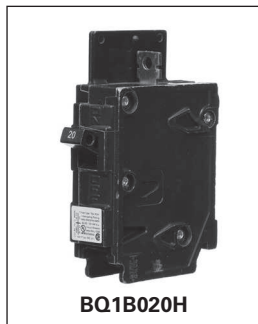

For inches / millimeters conversion, see Technical section.

① CQD breakers are rated 14,000 KAIC at 480/277V.

③ 3-pole only.

Molded Case Circuit Breakers

3VA CSA / UL Breakers

Reference Guide



Type	3VA51	3VA51	3VA52	3VA53	3VA54	3VA55													
Page	5-36	5-37	5-44	5-52	5-58	5-64													
Number of Poles	1	2, 3, 4	2 in 3-pole, 3, 4	2 in 3-pole, 3, 4	2 in 3-pole, 3, 4	3, 4													
3VA5 molded case circuit breakers																			
Size	125 A	125 A	250 A	400 A	600 A	800 A													
Rated current I_n	A 15 ... 125	15 ... 125	100 ... 250	200 ... 400	400 ... 600	600 ... 800													
Frequency	Hz 0 ... 400	0 ... 400	0 ... 400	0 ... 400	0 ... 400	0 ... 400													
Electrical characteristics according to CSA C22.2 No. 5 / UL 489																			
Rated operational voltage 50/60 Hz AC	V 347	600	600	600	600	600													
Electrical characteristics according to IEC 60947-2																			
Rated operational voltage U_n 50/60 Hz AC	V 415	690	690	690	690	690													
Rated insulation voltage U_i	V 500	800	800	800	800	800													
Rated impulse withstand voltage U_{imp}	kV 8	8	8	8	8	8													
Short-circuit breaking capacity according to CSA C22.2 No. 5 / UL 489 UL Breaker Type		(S) SEAS	(M) MEAS	(H) HEAS	(S) SEAS	(M) MEAS	(H) HEAS	(M) MFAS	(H) HFAS	(C) CFAS	(M) MJAS	(H) HJAS	(C) CJAS	(M) MLAS	(H) HLAS	(C) CLAS	(M) MMAS	(H) HMAS	(C) CMAS
	120 V AC / 50/60 Hz	kA 65	85	150	—	—	—	—	—	—	—	—	—	—	—	—	—	—	—
240 V AC / 50/60 Hz	kA —	—	—	65	85	100	85	100	200	85	100	200	85	100	200	85	100	200	200
277 V AC / 50/60 Hz	kA 25	35	50	—	—	—	—	—	—	—	—	—	—	—	—	—	—	—	—
347 V AC / 50/60 Hz	kA 14	18	18	—	—	—	—	—	—	—	—	—	—	—	—	—	—	—	—
480 Y/277 V AC / 50/60 Hz	kA —	—	—	25	35	65	35	65	100	35	65	100	35	65	100	35	65	100	100
480 V AC / 50/60 Hz	kA —	—	—	25	35	65	35	65	100	35	65	100	35	65	100	35	65	100	100
600 Y/347 V AC / 50/60 Hz	kA —	—	—	14	18	25	18	25	35	18	25	35	18	25	35	18	25	50	50
600 V AC / 50/60 Hz	kA —	—	—	—	—	—	18	25	35	18	25	35	18	25	35	18	25	50	50
125 V DC	kA 14	25	30	—	—	—	—	—	—	—	—	—	—	—	—	—	—	—	—
250 V DC	kA —	—	—	50	85	100	50	85	100	50	85	100	50	85	100	50	85	100	100
500 V DC	kA —	—	—	50	85	100	50	85	100	50	85	100	50	85	100	50	85	100	100
600 V DC (3-pole only)	kA —	—	—	—	—	—	50	85	100	50	85	100	50	85	100	50	85	100	100
750 V DC (4-pole only)	kA —	—	—	—	—	—	50	85	100	50	85	100	50	85	100	50	85	100	100
1000 V DC (4-pole only)	kA —	—	—	—	—	—	50	85	100	6	6	10	6	6	10	18	25	50	50
Short-circuit breaking capacity according to IEC 60947-2	(S)	(M)	(H)	(S)	(M)	(H)	(M)	(H)	(C)	(M)	(H)	(C)	(M)	(H)	(C)	(M)	(H)	(C)	(C)
Rated ultimate short-circuit breaking capacity I_{cu}	kA																		
Rated service short-circuit breaking capacity I_{cs} rms value, according to IEC 60947-2	kA																		
240 V AC / 50/60 Hz	kA 25/25	36/36	55/55	55/55	85/85	150/150	85/85	100/100	200/200	85/85	100/100	200/200	85/85	100/100	200/200	85	100	200	200
415 V AC / 50/60 Hz	kA 5/5	5/5	5/5	36/36	55/55	70/70	55/55	70/70	110/110	55/55	70/70	110/110	55/55	70/70	110/110	55	70	110	110
690 V AC / 50/60 Hz	kA —	—	—	5/5	7/5	10/5	7/7	10/10	10/10	7/7	10/10	10/10	7/7	10/10	10/10	25	35	35	35
125 V DC	kA 14	25	30	—	—	—	—	—	—	—	—	—	—	—	—	—	—	—	—
250 V DC	kA —	—	—	50	85	100	50	85	100	50	85	100	50	85	100	50	85	100	100
500 V DC	kA —	—	—	50	85	100	50	85	100	50	85	100	50	85	100	50	85	100	100
750 V DC (3-pole only)	kA —	—	—	—	—	—	50	85	100	50	85	100	50	85	100	50	85	100	100

– Not available

Applicable Standards:

- CSA C22.2 No. 5 / UL 489 - Molded Case Circuit Breakers
- UL486A - Wire connectors and solderless lugs for use with copper
- UL486B - Wire connectors and solderless lugs for use with aluminum wire
- CSA-22.2 No. 5-13 - Molded Case Circuit Breakers, Molded case switches and circuit breaker enclosures
- EN 60947-1 AMD 2 - Molded case circuit breakers
- EN 60947-2 AMD 2 2013
- EN 50581 2012 - RoHS compliant

Molded Case Circuit Breakers

3VA CSA / UL Breakers

Reference Guide



3VA61					3VA62					3VA63					3VA64					3VA65			3VA66		
5-40					5-48					5-54					5-60					5-65			5-68		
3, 4					3, 4					3, 4					3, 4					3, 4			3, 4		
150 A					250 A					400 A					600 A					800A			1000A		
15 ... 125					15 ... 125					100 ... 250					200 ... 400					600-800			1000		
0 ... 400					0 ... 400					0 ... 400					0 ... 400					50-60			50-60		
600					600					600					600					600			600		
690					690					690					690					690			690		
800					800					800					800					800			800		
8					8					8					8					8			8		
(M)	(H)	(C)	(L)	(E)	(M)	(H)	(C)	(H)	(E)	(M)	(H)	(C)	(L)	(E)	(M)	(H)	(C)	(L)	(E)	(M)	(H)	(C)	(M)	(H)	(C)
MDAE	HDAE	CDAE	LDAE	EDAE	MFAE	HFAE	CFAE	MFAE	EF AE	MJAE	HJAE	CJAE	LJAE	EJAE	MLAE	HLAE	CLAE	LLAE	ELAE	MMAE	HMAE	CMAE	MMNAE	HMNAE	CMNAE
—	—	—	—	—	—	—	—	—	—	—	—	—	—	—	—	—	—	—	—	—	—	—	—	—	—
100	100	200	200	—	100	100	200	200	—	100	100	200	200	—	100	100	200	200	—	100	150	200	100	150	200
—	—	—	—	—	—	—	—	—	—	—	—	—	—	—	—	—	—	—	—	—	—	—	—	—	—
—	—	—	—	—	—	—	—	—	—	—	—	—	—	—	—	—	—	—	—	—	—	—	—	—	—
35	65	100	150	200	35	65	100	150	200	35	65	100	150	200	35	65	100	150	200	35	65	100	35	65	100
35	65	100	150	200	35	65	100	150	200	35	65	100	150	200	35	65	100	150	200	35	65	100	35	65	100
18	22	35	50	100	18	22	35	50	100	18	22	35	50	100	18	22	35	50	100	25	35	50	25	35	50
18	22	35	50	100	18	22	35	50	100	18	22	35	50	100	18	22	35	50	100	25	35	50	25	35	50
—	—	—	—	—	—	—	—	—	—	—	—	—	—	—	—	—	—	—	—	—	—	—	—	—	—
—	—	—	—	—	—	—	—	—	—	—	—	—	—	—	—	—	—	—	—	—	—	—	—	—	—
—	—	—	—	—	—	—	—	—	—	—	—	—	—	—	—	—	—	—	—	—	—	—	—	—	—
—	—	—	—	—	—	—	—	—	—	—	—	—	—	—	—	—	—	—	—	—	—	—	—	—	—
—	—	—	—	—	—	—	—	—	—	—	—	—	—	—	—	—	—	—	—	—	—	—	—	—	—
(M)	(H)	(C)	(L)	(E)	(M)	(H)	(C)	(L)	(E)	(M)	(H)	(C)	(L)	(E)	(M)	(H)	(C)	(L)	(E)	(M)	(H)	(C)	(M)	(H)	(C)
—	—	—	—	—	—	—	—	—	—	—	—	—	—	—	—	—	—	—	—	85	110	200	85	110	200
55/55	85/85	110/110	150/150	200	55/55	85/85	110/110	150/150	200	55/55	85/85	110/110	150/150	200	55/55	85/85	110/110	150/150	200	55	85	110	55	85	110
—	—	—	—	3	—	—	—	—	3	—	—	—	—	3	—	—	—	—	3	25	35	35	25	35	35
—	—	—	—	—	—	—	—	—	—	—	—	—	—	—	—	—	—	—	—	—	—	—	—	—	—
—	—	—	—	—	—	—	—	—	—	—	—	—	—	—	—	—	—	—	—	—	—	—	—	—	—
—	—	—	—	—	—	—	—	—	—	—	—	—	—	—	—	—	—	—	—	—	—	—	—	—	—
—	—	—	—	—	—	—	—	—	—	—	—	—	—	—	—	—	—	—	—	—	—	—	—	—	—

CSA / UL Type Structure

Position 1 KAIC @ 480V	Position 2 Frame	Position 3 Family	Position 4 Trip System / Special Application
S = 25 = low M = 35 = med low H = 65 = med C = 100 = med high L = 150 = high E = 200 = extra high	E = 125A max D = 150A max F = 250A max J = 400A max L = 600A max M = 800A max MN = 1000A max	A = 3VA	S = Standard TMTU or MCS (Molded Case Switch) E = High End ETU B = Panelboard TMTU (Bolt-on) M = TMTU 50°C/NAVAL (UL 489 SB) P = TMTU MCP (Motor Circuit Protector) R = ETU MCP (Motor Circuit Protector)"

Molded Case Circuit Breakers

Reference Guide

Selection/Application

Thermal-Magnetic Trip Breakers

Page		General Purpose Breakers										
		HGG	LGG	ED2	ED4	ED6	HED4	CED6				
5		5-32	5-32	5-101	5-101	5-101	5-102	5-102				
Ratings	AC	Poles	1, 2, 3	1, 2, 3	1, 2, 3	1, 2, 3	1 [ⓐ] , 2, 3	1, 2, 3	2, 3			
		Amperes, Continuous	15-125	15-125	15-100	15-125	15-125 [ⓑ]	15-125	15-125			
		Volts 50/60HZ	347	347	120	277	347	277	—			
		Interrupt Rating Symmetrical RMS Amperes	CSA/UL	1-Pole	600/347	600/347	240	480	600	480	600	
				2-Pole 3-Pole	—	—	10,000	—	—	100,000	—	
			IEC 947-2 50/60HZ	220/240V	240V	85,000	100,000	10,000	65,000	65,000	100,000 [ⓑ]	200,000
					277V	—	—	—	22,000 [ⓑ]	—	65,000 [ⓑ]	—
				347V	—	—	—	—	30,000	—	—	
				480V	35,000	65,000	—	18,000	25,000	42,000	200,000	
				600V	14,000	14,000	—	—	18,000	—	100,000	
				500V	lcu	—	—	—	—	65,000	—	—
					lcs	—	—	—	—	17,000	—	—
				380/415V	lcu	—	—	—	—	35,000	—	—
		lcs	—		—	—	—	9,000	—	—		
	500V	lcu	—	—	—	—	18,000	—	—			
lcs		—	—	—	—	5,000	—	—				
DC	2-Pole, 250V DC Interrupting Ratings		35,000	42,000	5,000	30,000	30,000	30,000	30,000			
	3-Pole, 500V DC Interrupting Ratings [ⓑ]		—	—	—	—	18,000	—	50,000			
Dimensions in inches	Height	1-Pole	5.40 1.00	5.40 1.00	6.34 1.00	6.34 1.00	6.34 1.00	6.34 1.00	9.26 —			
		2-Pole 3-Pole 4-Pole	2.00 3.00 4.00	2.00 3.00 4.00	2.00 3.00 —	2.00 3.00 —	2.00 3.00 —	2.00 3.00 —	2.00 3.00 —			
	Width	2-Pole 3-Pole 4-Pole	2.00 3.00 4.00	2.00 3.00 4.00	2.00 3.00 —	2.00 3.00 —	2.00 3.00 —	2.00 3.00 —	2.00 3.00 —			
		Depth	2.90	2.90	4.00	4.00	4.00	4.00	4.00			
Overcurrent Devices	Thermal and Fixed Magnetic Trip		√	√	√	√	√	√				
	Thermal and Adjustable Magnetic Trip		—	—	—	—	—	—				
	Adjustable Magnetic Trip only		—	—	—	—	√	—				
	Motor Circuit Protector		—	—	—	—	—	√				
	Molded Case Switch		—	—	√	√	√	√				
Accessories & Modifications	Undervoltage Trip		—	—	√	√	√	√				
	Shunt Trip		√	√	√	√	√	√				
	Auxiliary Switch		√	√	√	√	√	√				
	Alarm Switch		√	√	√	√	√	√				
	Mechanical Interlock		—	—	—	—	—	—				
	Rear Connection Studs		—	—	√	√	√	√				
	Electric Motor Operator		—	—	√	√	√	√				
	Plug-In Mounting Assembly (3 Pole Only)		—	—	√	√	√	√				
	Fungus Proofing (ref. page 5-160)		√	√	√	√	√	√				
Individual Enclosures	Type 1 — Indoor Surface		√	√	√	√	√	√				
	Type 1 — Indoor, Flush		√	√	√	√	√	√				
	Type 3R — Outdoor-Rainproof		√	√	√	√	√	√				
	Type 12 — Lint, Fine Dust, Oils, Coolants		—	—	√	√	√	√				

For inches / millimeters conversion, see Technical section.

- ⓐ 1-pole only.
- ⓑ 35-100A: 25,000 AIR at 277V AC/15-30A:
65,000 AIR at 277V AC.
- ⓓ For DC UPS system application.
- ⓔ Single pole ED6 (15-30A) 30kA, (35-100A) 18 kA. CSA Only.
- ⓕ Single pole HED4, 15-30A: 65,000 AIR at 240V AC; single
pole HED4, 35-100A: 25,000 AIR at 240V AC.
- ⓖ HGG and LGG breakers are rated at 600/347V.
- ⓗ ED6, 2-pole available 15-125 amps only.

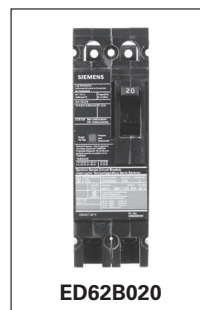

Molded Case Circuit Breakers

Reference Guide

Selection/Application

Thermal-Magnetic Trip Breakers

Page		General Purpose Breakers												
		FD6A, FXD6A	HFD6, HFXD6	HHFD6, HHFXD6	CFD6	JXD2-A	JD6-A, JXD6-A	HJD6-A, HJXD6-A	HHJD6-A, HHJXD6-A	CJD6-A				
Ratings	AC	Poles	2, 3	2, 3	2, 3	3	2, 3	2, 3	2, 3	2, 3	3			
		Amperes, Continuous	70-250	70-250	70-250	70-250	200-400	200-400	200-400	200-400	200-400			
		Volts 50/60HZ	2-Pole 3-Pole	600	600	600	600	240	600	600	600	600		
		Interrupt Rating Symmetrical RMS Amperes	CSA/UL	240V	65,000	100,000	200,000	200,000	65,000	65,000	100,000	200,000	200,000	
				480V	35,000	65,000	100,000	200,000	—	35,000	65,000	100,000	150,000	
				600V	22,000	25,000	25,000	100,000	—	25,000	35,000	50,000	100,000	
				IEC60947-2 50/60HZ	220/240V	lcu	65,000	100,000	—	—	—	65,000	100,000	—
			380/415V		lcs	33,000	50,000	—	—	—	33,000	50,000	—	—
					lcs	35,000	65,000	—	—	—	40,000	65,000	—	—
			500V		lcs	18,000	33,000	—	—	—	20,000	33,000	—	—
lcs	—			—	—	—	—	—	—	—	—			
DC	2-Pole 250V DC Interrupting Ratings	30,000	30,000	—	50,000	30,000	30,000	30,000	—	—				
	3-Pole, 500V DC Interrupting Ratings [Ⓞ]	18,000	25,000	—	50,000	—	25,000	35,000	—	50,000				
Dimensions in inches	Height	9.50	9.50	14.12	14.12	11.00	11.00	11.00	11.00	17.86				
	Width	2-Pole 3-Pole	4.50	4.50	4.50	4.50	7.50	7.50	7.50	7.50	7.50			
	Depth	4.00	4.00	4.00	4.00	4.00	4.00	4.00	4.00	4.00				
Overcurrent Devices	Thermal and Fixed Magnetic Trip	—	—	—	—	—	—	—	—	—				
	Thermal and Adjustable Magnetic Trip	✓	✓	✓	✓	✓	✓	✓	✓	✓				
	Adjustable Magnetic Trip Only Motor Circuit Protector	✓	—	—	✓	—	—	✓	✓	—				
	Molded Case Switch	✓	—	—	✓	✓	✓	—	—	✓				
Accessories & Modifica- tions	Undervoltage Trip	✓	✓	✓	✓	✓	✓	✓	✓	✓				
	Shunt Trip	✓	✓	✓	✓	✓	✓	✓	✓	✓				
	Auxiliary Switch	✓	✓	✓	✓	✓	✓	✓	✓	✓				
	Auxiliary Switch	✓	✓	✓	✓	✓	✓	✓	✓	✓				
	Mechanical Interlock	✓	✓	✓	✓	✓	✓	✓	✓	✓				
	Rear Connection Studs	✓	✓	✓	✓	✓	✓	✓	✓	✓				
	Electric Motor Operator	✓	✓	✓	✓	✓	✓	✓	✓	✓				
	Plug-In Mounting Assembly	✓	✓	✓	✓	✓	✓	✓	✓	✓				
Fungus Proofing (ref. page 5-160)	✓	✓	✓	✓	—	✓	✓	✓	✓					
Individual Enclosures	Type 1 — Indoor Surface	✓	✓	✓	✓	✓	✓	✓	✓	✓				
	Type 1 — Indoor, Flush	—	✓	—	✓	—	—	—	—	—				
	Type 3R — Outdoor-Rainproof	✓	✓	✓	✓	✓	✓	✓	✓	—				
	Type 12 — Lint, Fine Dust, Oils, Coolants	✓	✓	✓	✓	✓	✓	✓	✓	✓				

For inches / millimeters conversion, see Technical section.

Ⓞ For DC UPS application.

Molded Case Circuit Breakers

Reference Guide

Selection/Application

Thermal-Magnetic Trip Breakers

		General Purpose Breakers											
		LD6, LXD6	HLD6, HLXD6	HHLXD6, HHLXD6	CLD6-A	LMD6, LMXD6	HLMD6, HLMXD6	MD6, MXD6	HMD6, HMXD6	CMD6			
Page		5-111	5-112	5-112	5-112	5-115	5-103	5-118	5-119	5-119			
Ratings	AC	Poles	2, 3	2, 3	2, 3	3	2, 3	2, 3	2, 3	2, 3	3		
		Amperes, Continuous	250-600	250-600	250-600	450-600	500-800	500-800	500-800	500-800	400-800		
		Volts 50/60 HZ	2-Pole	600	600	600	600	600	600	600	600		
			3-Pole	600	600	600	600	600	600	600	600		
	Interrupt Rating Symmetrical RMS Amperes	CSA/UL	240V	65,000	100,000	200,000	200,000	65,000	100,000	65,000	100,000	200,000	
			480V	35,000	65,000	100,000	150,000	50,000	65,000	50,000	65,000	100,000	
			600V	25,000	35,000	50,000	100,000	25,000	50,000	25,000	50,000	65,000	
				65,000	100,000	—	—	65,000	100,000	65,000	100,000	—	
		IEC 947-2 50/60HZ	220/240V	lcu	33,000	50,000	—	—	33,000	50,000	33,000	50,000	—
			380/415V	lcu	40,000	65,000	—	—	40,000	65,000	40,000	65,000	—
				lcs	20,000	33,000	—	—	20,000	33,000	20,000	33,000	—
			500V	lcu	—	—	—	—	—	—	—	—	—
	DC	2-Pole 250V DC Interrupting Ratings	30,000	30,000	—	—	30,000	30,000	30,000	30,000	30,000		
3-Pole, 500V DC Interrupting Ratings [Ⓞ]		35,000	—	—	50,000	25,000	50,000	25,000	50,000	50,000			
Dimensions in inches	Height	11.00	11.00	11.00	17.86	16.00	16.00	16.00	16.00	16.00			
	Width	7.50	7.50	7.50	7.50	7.50	7.50	9.00	9.00	9.00			
	Depth	4.00	4.00	4.00	4.00	4.59	4.59	6.19	6.19	6.19			
Overcurrent Devices	Thermal and Adjustable Magnetic Trip	✓	✓	✓	✓	✓	✓	✓	✓	✓			
	Adjustable Magnetic Trip Only	✓	—	—	✓	✓	✓	✓	—	✓			
	Motor Circuit Protector	✓	—	—	✓	✓	—	✓	—	✓			
Accessories & Modifications	Molded Case Switch	✓	—	—	✓	✓	—	✓	—	✓			
	Undervoltage Trip	✓	✓	✓	✓	✓	✓	✓	✓	✓			
	Shunt Trip	✓	✓	✓	✓	✓	✓	✓	✓	✓			
	Auxiliary Switch	✓	✓	✓	✓	✓	✓	✓	✓	✓			
	Alarm Switch	✓	✓	✓	✓	✓	✓	✓	✓	✓			
	Mechanical Interlock	✓	✓	✓	✓	✓	✓	✓	✓	✓			
	Rear Connection Studs	✓	✓	✓	✓	✓	✓	✓	✓	✓			
	Electric Motor Operator	✓	✓	✓	✓	✓	✓	✓	✓	✓			
	Plug-In Mounting Assembly	✓	✓	✓	✓	—	—	✓	✓	✓			
Fungus Proofing (ref. page 5-160)	✓	✓	✓	✓	✓	✓	✓	✓	✓				
Individual Enclosures	Type 1 — Indoor Surface	✓	✓	✓	✓	—	—	✓	✓	✓			
	Type 1 — Indoor, Flush	—	—	—	—	—	—	—	—	—			
	Type 3R — Outdoor-Rainproof	✓	✓	✓	—	—	—	✓	✓	✓			
	Type 12 — Lint, Fine Dust, Oils, Coolants	—	—	—	—	—	—	✓	✓	✓			

For inches / millimeters conversion, see Technical section.

Ⓞ For DC UPS application.

Molded Case Circuit Breakers

Reference Guide

Selection/Application

Thermal-Magnetic Trip Breakers

Page				General Purpose Breakers							
				ND6, NXD6	HND6, HNXD6	CND6	PD6, PXD6 ^①	HPD6 ^② , HPXD6 ^②	CPD6 ^③		
Ratings				5-122	5-123	5-123	5-126	5-126	5-126		
	AC	Poles		2, 3	2, 3	3	3	3	3		
		Amperes, Continuous		800-1200	800-1200	800-1200	1200-1600	1200-1600	1200-1600		
		Volts 50/60 HZ		3-Pole	600	600	600	600	600	600	
		Interrupt Rating Symmetrical RMS Amperes	CSA/UL	240V	65,000	100,000	200,000	65,000	100,000	200,000	
				480V	50,000	65,000	100,000	50,000	65,000	100,000	
				600V	25,000	50,000	65,000	25,000	50,000	65,000	
			IEC 947-2 50/60HZ	220/240V	lcu	65,000	100,000	—	—	—	—
					lcs	33,000	50,000	—	—	—	—
				380/415V	lcu	40,000	65,000	—	—	—	—
			lcs	20,000	33,000	—	—	—	—		
	500V	lcu	—	—	—	—	—	—			
	lcs	—	—	—	—	—	—	—			
DC	2-Pole 250V DC Interrupting Ratings		30,000	30,000	30,000	30,000	30,000	30,000			
	3-Pole, 500V DC Interrupting Ratings ^①		25,000	50,000	50,000	25,000	50,000	50,000			
Dimensions in inches	Circuit breakers require Connect-all mounting block. Dimensions shown are for circuit breaker only.			Height	16.00	16.00	16.00	16.0	16.00	16.00	
				Width	9.00	9.00	9.00	9.00	9.00	9.00	
				Depth	6.19	6.19	6.19	6.19	6.19	6.19	
Overcurrent Devices	Thermal and Adjustable Magnetic Trip			√	√	√	√	√	√		
	Adjustable Magnetic Trip Only			—	—	—	—	—	—		
	Motor Circuit Protector			—	—	—	—	—	—		
Accessories & Modifications	Molded Case Switch			√	—	√	√	—	—		
	Undervoltage Trip			√	√	√	√	√	√		
	Shunt Trip			√	√	√	√	√	√		
	Auxiliary Switch			√	√	√	√	√	√		
	Alarm Switch			√	√	√	√	√	√		
	Mechanical Interlock			√	√	√	√	√	√		
	Rear Connections Studs			√	√	√	—	—	—		
	Electric Motor Operator			√	√	√	√	√	√		
	Plug-in Mounting Assembly			√	√	√	—	—	—		
	Fungus Proofing (ref. page 5-160)			√	√	√	√	√	√		
Mounting Block (required)			—	—	—	√	√	√			
Individual Enclosures	Type 1 – Indoor Surface			√	√	√	—	—	—		
	Type 1 – Indoor, Flush			—	—	—	—	—	—		
	Type 3R – Outdoor-Rainproof			√	√	√	—	—	—		
	Type 12 – Lint, Fine Dust, Oils, Coolants			—	—	—	—	—	—		

For inches / millimeters conversion, see Technical section.

- ① For DC UPS application.
- ② 2-pole design.
- ③ 3-pole design.

④ Requires Connect-all mounting assembly. Dimensions shown are for circuit breaker only.

Molded Case Circuit Breakers

Reference Guide

Selection/Application

Thermal-Magnetic Trip Breakers & Electronic Trip Breakers				General Purpose Breakers		Solid State Trip Circuit Breakers							
				RD6 [Ⓞ] , RXD6 [Ⓞ]	HRD6 [Ⓞ] , HRXD6 [Ⓞ]	SJD6	SHJD6	SCJD6	SLD6	SHLD6	SCLD6		
Page				5-129	5-129	5-109	5-109	5-109	5-113	5-113	5-113		
Ratings	AC	Poles		3	3	3	3	3	3	3	3		
		Amperes, Continuous			1600-2000	1600-2000	200-400	200-400	200-400	300-600	300-600	300-600	
		Volts 50/60 HZ		3-Pole	600	600	600	600	600	600	600	600	
		Interrupt Rating Symmetrical RMS Amperes	CSA/UL	240V	65,000	100,000	65,000	100,000	200,000	65,000	100,000	200,000	
				480V	50,000	65,000	35,000	65,000	150,000	35,000	65,000	150,000	
				600V	25,000	50,000	25,000	35,000	100,000	25,000	35,000	100,000	
			IEC60947-2 50/60HZ	220/240V	lcu	—	—	—	—	—	—	—	—
					lcs	—	—	—	—	—	—	—	—
				380/415V	lcu	—	—	—	—	—	—	—	—
			lcs	—	—	—	—	—	—	—	—		
		500V	lcu	—	—	—	—	—	—	—	—		
		lcs	—	—	—	—	—	—	—	—	—		
	DC	2-Pole 250V DC Interrupting Ratings		30,000	30,000	—	—	—	—	—	—		
		3-Pole, 500V DC Interrupting Ratings [Ⓞ]		25,000	50,000	—	—	—	—	—	—		
Dimensions in inches	Height		16.00	16.00	11.00	11.00	17.86	11.0	11.00	17.86			
	Width		3-Pole	9.00	9.00	7.50	7.50	7.50	7.50	7.50			
	Depth			6.19	6.19	4.00	4.00	4.00	4.00	4.00			
Overcurrent Devices	Solid State Trip		—	—	√	√	√	√	√	√			
	Thermal and Adjustable Magnetic Trip		√	√	—	—	—	—	—	—			
	Adjustable Magnetic Trip Only		—	—	—	—	—	—	—	—			
	Motor Circuit Protector		—	—	—	—	—	—	—	—			
Molded Case Switch		√	—	—	—	—	—	—	—				
Accessories & Modifications	Undervoltage Trip		√	√	√	√	√	√	√	√			
	Shunt Trip		√	√	√	√	√	√	√	√			
	Auxiliary Switch		√	√	√	√	√	√	√	√			
	Alarm Switch		√	√	√	√	√	√	√	√			
	Mechanical Interlock		√	√	√	√	√	√	√	√			
	Rear Connections Studs		—	—	√	√	√	√	√	√			
	Electric Motor Operator		√	√	√	√	√	√	√	√			
	Plug-In Mounting Assembly		—	—	√	√	√	√	√	√			
	Fungus Proofing (ref. page 5-160)		√	√	√	√	√	√	√	√			
	Mounting Block (required)		√	√	—	—	—	—	—	—			
Individual Enclosures	Type 1 — Indoor Surface		—	—	√	√	√	√	√	√			
	Type 1 — Indoor, Flush		—	—	—	—	—	—	—	—			
	Type 3R — Outdoor-Rainproof		—	—	√	√	—	√	√	—			
	Type 12 — Lint, Fine Dust, Oils, Coolants		—	—	√	√	√	—	—	—			

For inches / millimeters conversion, see Technical section.

[Ⓞ] Requires Connect-all mounting assembly. Dimensions shown are for circuit breaker only.

Molded Case Circuit Breakers

Reference Guide

Selection

Electronic Trip Breakers

Page				Solid State Trip Circuit Breakers								
				SMD6	SHMD6	SCMD6	SND6	SHND6	SCND6	SPD6 ^①	SHPD6 ^①	
Ratings				5-120	5-120	5-120	5-124	5-124	5-124	5-127	5-127	
Ratings	AC	Poles		3	3	3	3	3	3	3	3	
		Amperes, Continuous		600-800	600-800	600-800	800-1200	800-1200	800-1200	1200-600	1200-1600	
		Volts 50/60HZ		3-Pole	600	600	600	600	600	600	600	
		Interrupt Rating Symmetrical RMS Amperes	CSA/UL	240V	65,000	100,000	200,000	65,000	100,000	200,000	65,000	100,000
				480V	50,000	65,000	100,000	50,000	65,000	100,000	50,000	65,000
				600V	25,000	50,000	65,000	25,000	50,000	65,000	25,000	50,000
		IEC60947-2 50/60HZ	380/415V	lcu	—	—	—	—	—	—	—	—
				lcs	—	—	—	—	—	—	—	—
		690V		lcu	—	—	—	—	—	—	—	—
				lcs	—	—	—	—	—	—	—	—
Dimensions in inches	Height		10.00	16.00	16.00	16.00	16.00	16.00	16.00	16.00		
	Width		9.00	9.00	9.00	9.00	9.00	9.00	9.00	9.00		
	Depth		6.19	6.19	6.19	6.19	6.19	6.19	6.19	6.19		
Overcurrent Devices	Solid State Trip		✓	✓	✓	✓	✓	✓	✓	✓		
	Undervoltage Trip		✓	✓	✓	✓	✓	✓	✓	✓		
Accessories & Modifications	Shunt Trip		✓	✓	✓	✓	✓	✓	✓	✓		
	Auxiliary Switch		✓	✓	✓	✓	✓	✓	✓	✓		
	Alarm Switch		✓	✓	✓	✓	✓	✓	✓	✓		
	Mechanical Interlock		✓	✓	✓	✓	✓	✓	✓	✓		
	Rear Connection Studs		✓	✓	✓	✓	✓	✓	—	—		
	Electric Motor Operator		✓	✓	✓	✓	✓	✓	✓	✓		
	Plug-In Mounting Assembly		✓	✓	✓	✓	✓	✓	—	—		
	Fungus Proofing (ref. page 5-160)		✓	✓	✓	✓	✓	✓	✓	✓		
Individual Enclosures	Type 1 — Indoor Surface		✓	✓	✓	✓	✓	✓	—	—		
	Type 1 — Indoor, Flush		—	—	—	—	—	—	—	—		
	Type 3R — Outdoor-Rainproof		✓	✓	✓	✓	✓	✓	—	—		
	Type 12 — Lint, Fine Dust, Oils, Coolants		✓	✓	✓	✓	✓	✓	—	—		

For inches / millimeters conversion, see Technical section.

① Requires connect-all mounting block assembly. Dimensions shown are for circuit breaker.

② Breaker has rating plugs which can be changed within each frame rating.

Molded Case Circuit Breakers

Reference Guide

Selection/Application

Page		5-166			5-170			5-174			
Breaker Frame Family		DG			FG			JG			
	Continuous Amps	30–150A			40–250A			70–400A			
	Poles	2, 3			2, 3			2, 3			
	Max. Volts AC	600Y/347V			600Y/347V			600V			
Breaker Type		NDGA	HDGA	LDGA	NFGA	HFGA	LFGA	NJGA	HJGA	LJGA	
Ratings	Interrupting Class		N	H	L	N	H	L	N	H	L
	Interrupting Rating RMS Symmetrical Amperes AC 50/60Hz	240Vac	65	100	200	65	100	200	65	100	200
		CSA/UL 480Vac	35	65	100	35	65	100	35	65	100
		600Vac	18	18	18	18	18	18	25	25	25
		220/240Vac	65/65	100/75	200/150	65/65	100/75	200/150	65/65	100/75	200/150
		I _c /I _{cs} 380/415Vac	40/40	70/70	100/75	40/40	70/70	100/75	45/45	70/70	100/75
	690Vac	12/6	12/6	12/6	12/6	12/6	12/6	12/6	15/8	15/8	
DC Interrupting Ratings (CSA/UL) ^②	250Vdc (2-Pole)	30	30	30	30	30	30	30	30	30	
	500Vdc (3-Pole) ^①	18	18	18	18	18	30	25	35	35	
Dimensions in Inches	1-Pole	—						—			
	2-Pole	6.9H x 4.1W x 3.4D						11H x 5.5W x 4.2D			
	3-Pole	6.9H x 4.1W x 3.4D						11H x 5.5W x 4.2D			
	4-Pole	—						—			
Trip Unit Information	Thermal-Magnetic	◆			◆			◆			
	Electronic	◆			◆			◆			
	Electronic with LCD	◆			◆			◆			
	Interchangeable Trip Unit	—			—			—			
	Reverse Feed (w/Non-Interchangeable Trip)	◆			◆			◆			
	Communications Capability ^③	◆			◆			◆			
Specific Application Breakers	Molded Case Switch	◆			◆			◆			
	Motor Circuit Protector	◆			◆			◆			
	100% Rated	◆			◆			◆			
	50°C Calibrated ^④										
Accessories & Modifications	Auxiliary Switch	◆			◆			◆			
	Alarm Switch	◆			◆			◆			
	Shunt Trip	◆			◆			◆			
	Undervoltage Release	◆			◆			◆			
	Mechanical Interlocks	◆			◆			◆			
	Electric Motor or Stored Energy Operator	◆			◆			◆			
	Rear Connecting Studs	◆			◆			◆			
	Plug-In Mounting Assy. w/Trip Interlock	◆			◆			◆			
	Draw-Out Assembly	◆			◆			◆			
	Handle Mechanism Options	◆			◆			◆			
	Terminal Shields	◆			◆			◆			
	Distribution Lugs	◆			◆			◆			
	Ground Sensor (Neutral Transformer)	◆			◆			◆			

① 500Vdc nominal, for ungrounded DC UPS systems.

② DC Interrupting Ratings are not applicable to electronic circuit breakers.

③ Communications available via a COMPRO or COMMODO modules using Profibus or Modbus protocols.

④ Consult Siemens for availability.

⑤ Special version, see page 5-215 – 5-216.

GG are not VL family breakers and do not share common VL accessories.

⑥ 304 and 316 Stainless Steel

Molded Case Circuit Breakers

Reference Guide

Selection/Application

Page		5-178			5-182			5-186			5-190				
Breaker Frame Family		LG			MG			NG			PG				
	Continuous Amps	150–600A			200–800A			300–1200A			400–1600A				
	Poles	2, 3			2, 3			2, 3			3				
	Max. Volts AC	600V			600V			600V			600V				
Breaker Type		NLGB	HLGB	LLGB	NMG	HMG	LMG	NNG	HNG	LNG	NPG	HPG	LPG		
Ratings	Interrupting Class		N	H	L	N	H	L	N	H	L	N	H	L	
	Interrupting Rating RMS Symmetrical Amperes AC 50/60Hz	CSA/UL	240Vac	65	100	200	65	100	200	65	100	200	65	100	200
			480Vac	35	65	100	35	65	100	35	65	100	35	65	100
			600Vac	18 [Ⓞ]	18	18	25	35	65	25	35	65	25	35	65
		I _{cs} /I _{cs}	220/240Vac	65/65	100/75	200/150	65/35	100/50	200/150	65/65	100/75	200/100	65/35	100/50	200/100
			380/415Vac	45/45	70/70	100/75	50/50	70/70	100/75	50/25	70/35	100/50	50/25	70/35	100/50
			690Vac	12/6	15/8	15/8	20/10	30/15	35/17	20/10	30/15	35/17	20/10	30/15	35/15
	DC Interrupting Ratings (CSA/UL) [Ⓢ]	250Vdc (2-Pole)	30	30	30	22	25	42	22	25	42	22	25	42	
		500Vdc (3-Pole) [Ⓢ]	25	35	35	35	50	65	35	50	65	35	50	65	
Dimensions in Inches	2-Pole	11H x 5.5W x 4.2D			16H x 7.5W x 4.7D			16H x 9W x 6.2D			—				
	3-Pole	11H x 5.5W x 4.2D			16H x 7.5W x 4.7D			16H x 9W x 6.2D							
Trip Unit Information	Thermal-Magnetic	◆			◆			◆			◆				
	Electronic	◆			◆			◆			◆				
	Electronic with LCD	◆			◆			◆			◆				
	Interchangeable Trip Unit	◆			◆			◆			◆				
	Reverse Feed (w/Non-Interchangeable Trip)	◆			◆			◆			◆				
	Communications Capability [Ⓢ]	◆			◆			◆			◆				
Specific Application Breakers	Molded Case Switch	◆			◆			◆			◆				
	Motor Circuit Protector	◆			◆			◆			◆				
	100% Rated [Ⓢ]	◆			◆			◆			◆				
Accessories and Modifications	Auxiliary Switch	◆			◆			◆			◆				
	Alarm Switch	◆			◆			◆			◆				
	Shunt Trip	◆			◆			◆			◆				
	Undervoltage Release	◆			◆			◆			◆				
	Mechanical Interlocks	◆			◆			◆			◆				
	Electric Motor or Stored Energy Operator	◆			◆			◆			◆				
	Rear Connecting Studs	◆			◆			◆			◆				
	Plug-In Mounting Assy. w/Trip Interlock	◆			◆			◆			◆				
	Draw-Out Assembly	◆			◆			◆			◆				
	Handle Mechanism Options	◆			◆			◆			◆				
	Terminal Shields	◆			◆			◆			◆				
	Distribution Lugs	◆			◆			◆			◆				
	Ground Sensor (Neutral Transformer)	◆			◆			◆			◆				

[Ⓢ] Communications available via COMPRO or COMMOD modules using Profibus or Modbus protocol.
[Ⓢ] 500Vdc nominal, for ungrounded DC UPS systems.
[Ⓢ] DC Interrupting Ratings are not applicable to electronic circuit breakers.
[Ⓢ] LG frame maximum 500A.
[Ⓢ] Special version, see page 5-215 – 5-216.
[Ⓢ] Special 600Vac 25kA version available, see page 5-215 – 5-216.

Molded Case Circuit Breakers

Panelboard Mounting Circuit Breakers

Selection

Arc-Fault Circuit Interrupters (AFCI)

AFCI's detect arcing faults (an unintentional arcing condition in a circuit) that standard circuit breakers are unable to detect. The device is intended to mitigate the effects of arcing faults by functioning to de-energize the circuit when an arc-fault is detected.

Combination Type AFCI

Detects all three possible types of arc fault: line-to-ground, line-to-neutral, and series.

Breaker Type	Ampere Rating	10,000 A IR Catalog Number	22,000 A IR Catalog Number	65,000 A IR Catalog Number
BAF2/BAFH2/HBAF2 1-Pole 120V AC	15	BA115AFC [Ⓞ]	BA115AFCH	BA115AFCHH
	20	BA120AFC [Ⓞ]	BA120AFCH	BA120AFCHH
BAF/BAFH 2-Pole 120/240V AC	15	B215AFC [Ⓞ]	B215AFCH	—
	20	B220AFC [Ⓞ]	B220AFCH	—

Branch-Feeder AFCI

Detects line-to-ground and line-to neutral arcs.

BAF2/BAFH2/HBAF2 1-Pole 120V AC	Ampere Rating	BA115AF [Ⓞ] BA120AF [Ⓞ]	BA115AFH [■] BA120AFH [■]	BA115AFHH [■] BA120AFHH [■]
	15 20			

NEW Dual Function AFCI/GFCI

The Dual Function Circuit Breaker combines Combination Type AFCI and GFCI, protecting against both Arc Faults and (5mA) Ground Faults. The device includes the Self Test feature, making it the first in class in electrical safety for homeowners.

BFGA2/BFGAH2/HBFGA2 1-Pole 120V AC	Ampere Rating	B115DF B120DF	B115DFH [■] B120DFH [■]	B115DFHH [■] B120DFHH [■]
	15 20			

Ground-Fault Circuit Interrupters (GFCI)

Provides Class A (5mA) ground fault protection. Intended for personnel protection. De-energizes the circuit for all ungrounded conductors of the circuit.

Breaker Type	Amp Rating	10k A IR Cat. No.	22k A IR Cat. No.	65k A IR Cat. No.
BLF/BLHF 1-Pole 120V AC Bolt-On	15	BF115A [Ⓞ]	BF115AH [Ⓞ]	BF115AHH
	20	BF120A [Ⓞ]	BF120AH [Ⓞ]	BF120AHH
	25	BF125A	BF125AH	—
	30	BF130A	BF130AH	BF130AHH
BLF/BLHF 2-Pole 120/240V AC Bolt-On	15	BF215A	BF215AH	—
	20	BF220A	BF220AH	—
	30	BF230A	BF230AH	—
	40	BF240A	BF240AH	—
	50	BF250A	BF250AH	—
	60	BF260A	BF260AH	—

Ground Fault Equipment Protection (30mA)

Provides protection of equipment from damaging line-to-ground faults currents. De-energizes the circuit for all ungrounded conductors of the circuit.

Breaker Type	Amp Rating	10k A IR Cat. No.	22k A IR Cat. No.
BLE/ BLEH 1-Pole, 120V AC Bolt-On	15	BE115 [Ⓞ]	BE115H [Ⓞ]
	20	BE120 [Ⓞ]	BE120H [Ⓞ]
	30	BE130	BE130H [■]
BLE/ BLEH 2-Pole 120/240V AC Bolt-On	15	BE215	BE215H [■]
	20	BE220	BE220H [■]
	30	BE230	BE230H [■]
	40	BE240	BE240H [■]
	50	BE250	BE250H [■]
	60	BE260	BE260H [■]

QAF2/QPF/QE Accessories

Description	Catalog Number
Padlocking Device 1-Pole	ECPLD1
Padlocking Device 2-Pole	ECPLD2
Handle Block	ECBX231M

■ Built to order. Allow 8-10 weeks for delivery.
[Ⓞ] CSA / UL Listed as SWD (Switching Duty) Rated, suitable for 120V AC Fluorescent Lighting.

• CSA / UL Listed • HACR Rated

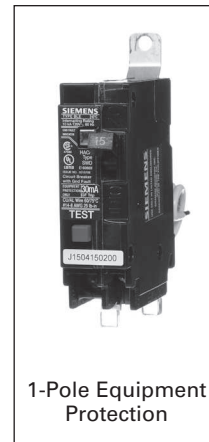
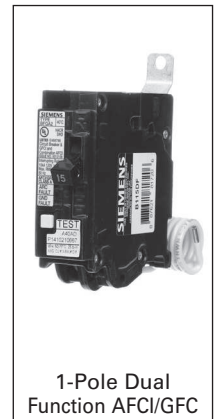
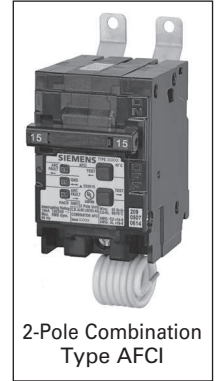
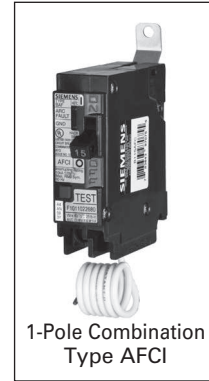

Wiring Diagrams

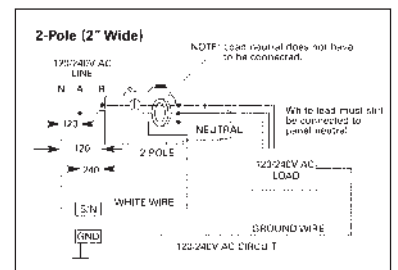
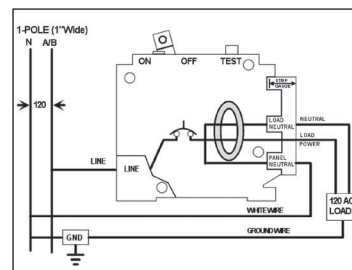

Molded Case Circuit Breakers

Panelboard Mounting with INSTA-WIRE

Selection

1-Pole Bolt-On (120V AC)^⑤

Continuous Current Rating @ 40° C	Type BL ^{①②}	Type BLH ^{①②}	Type HBL ^{①②}
	10,000A IR	22,000A IR	65,000A IR
	Catalogue Number	Catalogue Number	Catalogue Number
15	B115 ^③	B115H ^④	B115HH ^④
20	B12 ^③	B120H ^④	B120HH ^④
25	B125	B125H	B125HH■
30	B130	B130H	B130HH
35	B135	B135H■	B135HH■
40	B140	B140H	B140HH
45	B145■	B145H■	B145HH■
50	B150	B150H	B150HH■
60	B160	B160H■	B160HH■
70	B170	B170H■	B170HH■

2-Pole Bolt-On (Common-Trip 120/240V AC)^④

15	B215	B215H	B215HH
20	B220	B220H	B220HH
25	B225	B225H■	B225HH■
30	B230	B230H	B230HH
35	B235	B235H■	B235HH■
40	B240	B240H	B240HH
45	B245	B245H■	B245HH■
50	B250	B250H	B250HH
60	B260	B260H	B260HH
70	B270	B270H■	B270HH■
80	B280	B280H■	B280HH■
90	B290	B290H■	B290HH■
100	B2100	B2100H	B2100HH
110	B2110■	B2110H■	B2110HH■
125	B2125	B2125H	B2125HH■

2-Pole Bolt-On (Common-Trip 240V AC)^{③⑥⑦}

15	B215R	—	—
20	B220R	—	—
30	B230R	—	—
40	B240R■	—	—
50	B250R	—	—

3-Pole Bolt-On (Common-Trip 240V AC)^⑦

15	B315	B315H	B315HH
20	B320	B320H	B320HH
25	B325	B325H	B325HH■
30	B330	B330H	B330HH
35	B335	B335H■	B335HH■
40	B340	B340H	B340HH
45	B345	B345H■	B345HH■
50	B350	B350H	B350HH
60	B360	B360H	B360HH
70	B370	B370H	B370HH
80	B380	B380H■	B380HH
90	B390	B390H■	B390HH
100	B3100	B3100H	B3100HH

BL/BLH/HBL Internal Accessories

Description	Catalogue Number	Field/Factory Installed
120VAC Shunt Trip	add suffix...00S01■	Factory
24VAC Shunt Trip	add suffix...00S07■	Factory
120V Auxiliary Switch	add suffix...01■ ^②	Factory

■ Built to order. Allow 2-3 weeks for delivery

① CSA Certified / UL Listed for use with 60/75° wire through 40 amps, CSA Certified / UL Listed for use with 75° wire only for 50 amps and above, HACR rated. 120V AC Fluorescent Lighting.
② 1A and 1B contacts.

③ CSA Certified / UL Listed for use on 3-phase grounded "B" systems — 10,000 for this application.
④ CSA Certified / UL Listed for frequent switching applications (SWD).
⑤ Shipped 12 per sleeve.
⑥ Shipped 6 per sleeve.

⑦ Shipped 4 per sleeve.
⑧ CSA Certified / UL Listed 5KA IR.
⑨ 10 Amp breaker does not have INSTA-WIRE.
⑩ For 3 Phase Applications.
⑪ CSA Certified / UL Listed for reverse feed."
⑫ CSA Certified for frequent switching applications (SWD)

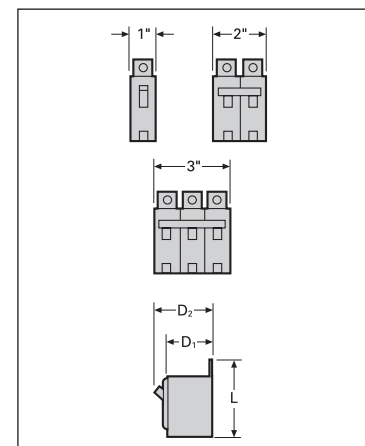
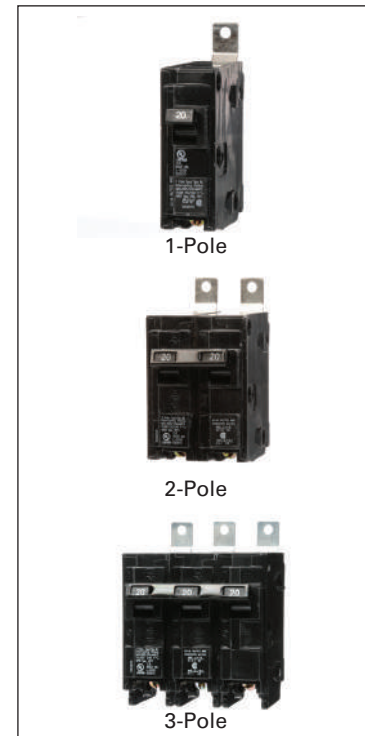

Breaker Type	Amperes	Dimensions		
		L	D1	D2
BL, BLH	15-50	3 ⁵ / ₁₆	2 ⁵ / ₁₆	3
BL, BLH	55-125	3 ³ / ₄	2 ⁵ / ₁₆	3
HBL	15-125	3 ³ / ₄	2 ⁵ / ₁₆	3

For external accessories, please refer to page 5-154 - 5-159

Molded Case Circuit Breakers

BQD 100A Frame Panelboard Mounting Circuit Breakers

BQD^④

Continuous Current Rating @ 40°C	1-Pole	2-Pole ^⑤	3-Pole ^③
	277V AC–125V DC Catalog Number	480Y/277V AC– 125/250V DC Catalog Number	480Y/277V AC Catalog Number
15	BQD115 ^{①②}	BQD215 ^⑤	BQD315 ^⑤
20	BQD120 ^{①②}	BQD220 ^⑤	BQD320 ^⑤
25	BQD125 ^⑤	BQD225 ^⑤	BQD325 ^⑤
30	BQD130 ^②	BQD230 ^⑤	BQD330 ^⑤
35	BQD135 ^②	BQD235 ^⑤	BQD335 ^⑤
40	BQD140 ^②	BQD240 ^⑤	BQD340 ^⑤
45	BQD145 ^{②■}	BQD245 ^⑤	BQD345 ^⑤
50	BQD150 ^②	BQD250 ^⑤	BQD350 ^⑤
60	BQD160	BQD260	BQD360
70	BQD170■	BQD270	BQD370
80	BQD180■	BQD280	BQD380
90	BQD190■	BQD290	BQD390
100	BQD1100■	BQD2100	BQD3100

BQD6 CSA Certified

Continuous Current Rating @ 40°C	1-Pole	2-Pole ^⑤	3-Pole ^③
	347V AC Catalog Number	600/347V AC Catalog Number	600/347V AC Catalog Number
15	BQD6115 ^①	BQD6215	BQD6315
20	BQD6120 ^①	BQD6220	BQD6320
25	BQD6125■	BQD6225■	BQD6325■
30	BQD6130	BQD6230	BQD6330
35	BQD6135■	BQD6235■	BQD6335■
40	BQD6140■	BQD6240■	BQD6340
45	BQD6145■	BQD6245■	BQD6345■
50	BQD6150■	BQD6250■	BQD6350
60	BQD6160■	BQD6260■	BQD6360
70	BQD6170■	BQD6270■	BQD6370

Interrupting Ratings

Breaker Type	Number of Poles	RMS Symmetrical Amperes (KA)							
		Volts AC						Volts DC	
		120	240	277	480/277	347	600/277	125	125/250
BQD (CSA/UL)	1	65	—	14	—	—	—	14	—
	2	—	65	—	14	—	—	—	14
	3	—	65	—	14	—	—	—	—
BQD6 (CSA)	1	65	—	—	—	10	—	14	—
	2	—	65	—	—	—	10	—	14
	3	—	65	—	—	—	10	—	—

For inches / millimeters conversion, see Technical section.
■ Built to order. Allow 2–3 weeks for delivery.

① CSA Certified / UL Rated SWD rated for switching fluorescent lighting.
② HID rated at 277V AC.
③ Not suitable for 3-phase delta 480V applications.
④ HACR rated.

Selection/Dimensions

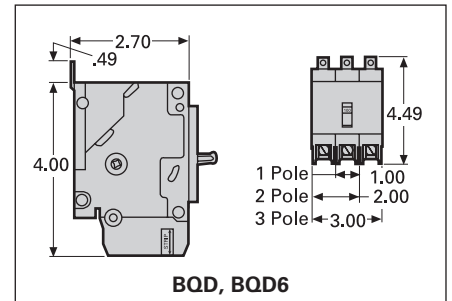

Shipping Weights

Number of Poles	Number per Carton	Shipping Weight (lbs.) (ea.)
1	1/12/48	0.6
2	1/6/24	1.2
3	1/4/16	2.0

Lugs For 60/75°C Wire

BQD – Load End Only	
15–40	#14–#6 AWG Cu #12–#6 AWG Al
45–100	#9–#1 AWG Cu #6–#1/0 AWG Al

For external accessories, please refer to pages 5-154 - 5-159
For internal accessories, please refer to page 5-151 - 5-153

Molded Case Circuit Breakers

GB2 Frame

Selection

Type NGB2[®] (Panelboard Mount)

Continuous Current Rating @ 40°C	1-Pole	2-Pole	3-Pole
	Catalogue Number	Catalogue Number	Catalogue Number
15	NGB1K015B ^{①②}	NGB2K015B ^②	NGB3K015B ^②
20	NGB1K020B ^{①②}	NGB2K020B ^②	NGB3K020B ^②
25	NGB1K025B ^②	NGB2K025B ^②	NGB3K025B ^②
30	NGB1K030B ^②	NGB2K030B ^②	NGB3K030B ^②
35	NGB1K035B ^②	NGB2K035B ^②	NGB3K035B ^②
40	NGB1K040B ^②	NGB2K040B ^②	NGB3K040B ^②
45	NGB1K045B ^②	NGB2K045B ^②	NGB3K045B ^②
50	NGB1K050B ^②	NGB2K050B ^②	NGB3K050B ^②
60	NGB1K060B	NGB2K060B	NGB3K060B
70	NGB1K070B	NGB2K070B	NGB3K070B
80	NGB1K080B	NGB2K080B	NGB3K080B
90	NGB1K090B	NGB2K090B	NGB3K090B
100	NGB1K100B	NGB2K100B	NGB3K100B
110	NGB1K110B	NGB2K110B	NGB3K110B
125	NGB1K125B	NGB2K125B	NGB3K125B

Load lugs are included as standard. HACR rated.

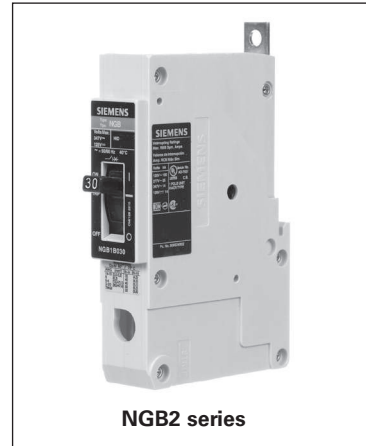

Type HGB2[®] (Panelboard Mount)

Continuous Current Rating @ 40°C	1-Pole	2-Pole	3-Pole
	Catalogue Number	Catalogue Number	Catalogue Number
15	HGB1K015B ^{①②}	HGB2K015B ^②	HGB3K015B ^②
20	HGB1K020B ^{①②}	HGB2K020B ^②	HGB3K020B ^②
25	HGB1K025B ^②	HGB2K025B ^②	HGB3K025B ^②
30	HGB1K030B ^②	HGB2K030B ^②	HGB3K030B ^②
35	HGB1K035B ^②	HGB2K035B ^②	HGB3K035B ^②
40	HGB1K040B ^②	HGB2K040B ^②	HGB3K040B ^②
45	HGB1K045B ^②	HGB2K045B ^②	HGB3K045B ^②
50	HGB1K050B ^②	HGB2K050B ^②	HGB3K050B ^②
60	HGB1K060B	HGB2K060B	HGB3K060B
70	HGB1K070B	HGB2K070B	HGB3K070B
80	HGB1K080B	HGB2K080B	HGB3K080B
90	HGB1K090B	HGB2K090B	HGB3K090B
100	HGB1K100B	HGB2K100B	HGB3K100B
110	HGB1K110B	HGB2K110B	HGB3K110B
125	HGB1K125B	HGB2K125B	HGB3K125B

Type LGB2[®] (Panelboard Mount)

Continuous Current Rating @ 40°C	1-Pole	2-Pole	3-Pole
	Catalogue Number	Catalogue Number	Catalogue Number
15	LGB1K015B ^{①②}	LGB2K015B ^②	LGB3K015B ^②
20	LGB1K020B ^{①②}	LGB2K020B ^②	LGB3K020B ^②
25	LGB1K025B ^②	LGB2K025B ^②	LGB3K025B ^②
30	LGB1K030B ^②	LGB2K030B ^②	LGB3K030B ^②
35	LGB1K035B ^②	LGB2K035B ^②	LGB3K035B ^②
40	LGB1K040B ^②	LGB2K040B ^②	LGB3K040B ^②
45	LGB1K045B ^②	LGB2K045B ^②	LGB3K045B ^②
50	LGB1K050B ^②	LGB2K050B ^②	LGB3K050B ^②
60	LGB1K060B	LGB2K060B	LGB3K060B
70	LGB1K070B	LGB2K070B	LGB3K070B
80	LGB1K080B	LGB2K080B	LGB3K080B
90	LGB1K090B	LGB2K090B	LGB3K090B
100	LGB1K100B	LGB2K100B	LGB3K100B
110	LGB1K110B	LGB2K110B	LGB3K110B
125	LGB1K125B	LGB2K125B	LGB3K125B

Shipping Weights

Number of Poles	Number per Carton	Shipping Weight lbs. (kg)
1	1	.75 (.34)
2	1	1.3 (.59)
3	1	2.0 (.98)

Lugs for 60/75°C Wire

Type	Ampere Rating	Wire Size	Catalog Number
NGB2 HGB2 LGB2	15-30A	#14-#6 AWG Cu	TC1Q1 (qty. 1) 3TC1Q1 (qty. 3)
		#12-#6 AWG Al	
NGB2 HGB2 LGB2	35-125A	#8-1/0 AWG Cu	3TC1GG20
		#8-2/0 AWG Al	

Interrupting Ratings (max. RMS symmetrical amperes kA)

Type	Poles	CSA 22.2 No. 5 / UL 489							
		Volts AC						Volts DC	
		120	240	277	480	347	600Y/347	125	125/250
NGB2	1	100	—	25	—	14	—	14	—
	2, 3	—	100	—	25	—	14	—	14 ^④
HGB2	1	100	—	35	—	22	—	14	—
	2, 3	—	100	—	35	—	22	—	14 ^④
LGB2	1	100	—	65	—	25	—	14	—
	2, 3	—	100	—	65	—	25	—	14 ^④

① SWD rated

② HID rated

③ 2-pole only

④ 2-pole only or two outer poles of 3-pole breaker

⑤ Suitable for reverse feed applications

For external accessories, please refer to pages 5-154 - 5-159
For internal accessories, please refer to page 5-151 - 5-153

Molded Case Circuit Breakers

GB Frame

Selection

Type NGB Frame^⑤ (Panelboard Mount)

Continuous Current Rating @ 40°C	1-Pole	2-Pole	3-Pole
	Catalog Number	Catalog Number	Catalog Number
15	NGB1B015B ^{①②}	NGB2B015B ^②	NGB3B015B ^②
20	NGB1B020B ^{①②}	NGB2B020B ^②	NGB3B020B ^②
25	NGB1B025B ^②	NGB2B025B ^②	NGB3B025B ^②
30	NGB1B030B ^②	NGB2B030B ^②	NGB3B030B ^②
35	NGB1B035B ^②	NGB2B035B ^②	NGB3B035B ^②
40	NGB1B040B ^②	NGB2B040B ^②	NGB3B040B ^②
45	NGB1B045B ^②	NGB2B045B ^②	NGB3B045B ^②
50	NGB1B050B ^②	NGB2B050B ^②	NGB3B050B ^②
60	NGB1B060B	NGB2B060B	NGB3B060B
70	NGB1B070B	NGB2B070B	NGB3B070B
80	NGB1B080B	NGB2B080B	NGB3B080B
90	NGB1B090B	NGB2B090B	NGB3B090B
100	NGB1B100B	NGB2B100B	NGB3B100B
110	NGB1B110B	NGB2B110B	NGB3B110B
125	NGB1B125B	NGB2B125B	NGB3B125B



NGB1B030B

Load lugs are included as standard. HACR rated.

Shipping Weights

Number of Poles	Number per Carton	Shipping Weight (lbs.) (ea.)
1	1	0.9 (0.4)
2	1	1.9 (0.9)
3	1	2.9 (1.2)

Lugs For 60/75°C Wire

NGB		
Ampere Rating	Wire Size	Catalogue Number
15-30A	#14-#6 AWG Cu	Integral with breaker
	#12-#6 AWG Al	
35-125A	#8-1/0 AWG Cu	Integral with breaker
	#8-2/0 AWG Al	

Interrupting Ratings (max. RMS symmetrical amperes kA)

Breaker Type	Number of Poles	CSA 22.2 No. 5 / UL 489							
		Volts AC						Volts DC	
		120	240	277	480Y/277	347	600Y/277	125	125/250
NGB	1	100	—	25	14	—	—	14	—
	2,3	—	100	—	—	25	14	—	14 ^④

① SWD rated.
② HID rated.

③ 2-pole only.
④ 2-pole only or two outer poles of 3-pole breaker
⑤ Suitable for reverse feed applications

For external accessories, please refer to pages 5-154 - 5-159
For internal accessories, please refer to page 5-151 - 5-153

Molded Case Circuit Breakers

Accessories

Selection

Shunt Trip

Control Voltage		BQD, BQD6, CQD, CQD6, NGG, HGG, LGG, NGB, NGB2, HGB, HGB2, LGB2 and LGB2
V AC	V DC	
120	—	CQDST120
240	—	CQDST240
277	—	CQDST277
480	—	CQDST480
600	—	CQDST600
—	12	CQDST12
—	24	CQDST24
—	48	CQDST48
—	125	CQDST125



Auxiliary Switch

Maximum Voltage		Number of Contacts	BQD, BQD6, CQD, CQD6,NGG, HGG, LGG, NGB, NGB2, HGB, HGB2, LGB2 and LGB2
AC	DC		
240	125	1A-1B	CQDA1
240	125	2A-2B	CQDA2

Alarm Switch

Maximum Voltage		BQD, BQD6, CQD, CQD6, NGG, HGG, LGG, NGB, NGB2, HGB, HGB2, LGB and LGB2
AC	DC	
240	125	CQDBA

Shunt Trip and Auxiliary Switch Combinations

Shunt Trip Voltage		BQD, BQD6, CQD, CQD6, NGG, HGG, LGG, NGB, NGB2, HGB, HGB2, LGB and LGB2
AC	DC	
24	—	CQDST24AAS
120	—	CQDST120AAS
240	—	CQDST240AAS
277	—	CQDST277AAS
480	—	CQDST480AAS
600	—	CQDST600AAS
—	12	CQDST12DAS
—	24	CQDST24DAS
—	48	CQDST48DAS
—	125	CQDST125DAS

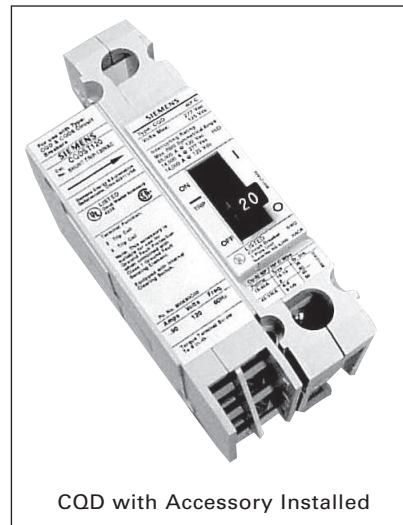

Alarm and Auxiliary Switch Combinations

For Breaker	Catalog Number
BQD, BQD6, CQD, NGG, HGG, LGG, NGB, HGB and LGB	CQDA1BA

①Adds 1-pole space for accessory.

Molded Case Circuit Breakers

3VA41 125A Thermal-magnetic Trip Circuit Breakers

Selection

3VA41 125A Frame, 3-Pole Thermal-Magnetic Trip Unit

Cont. Ampere Rating	S-Interrupting Class (SEAB)	M-Interrupting Class (MEAB)	H-Interrupting Class (HEAB)
	Catalog Number	Catalog Number	Catalog Number

TM210 FTFM

Cont. Ampere Rating	S-Interrupting Class (SEAB)	M-Interrupting Class (MEAB)	H-Interrupting Class (HEAB)
15	3VA4195-4ED34-0AA0	3VA4195-5ED34-0AA0	3VA4195-6ED34-0AA0
20	3VA4120-4ED34-0AA0	3VA4120-5ED34-0AA0	3VA4120-6ED34-0AA0
25	3VA4125-4ED34-0AA0	3VA4125-5ED34-0AA0	3VA4125-6ED34-0AA0
30	3VA4130-4ED34-0AA0	3VA4130-5ED34-0AA0	3VA4130-6ED34-0AA0
35	3VA4135-4ED34-0AA0	3VA4135-5ED34-0AA0	3VA4135-6ED34-0AA0
40	3VA4140-4ED34-0AA0	3VA4140-5ED34-0AA0	3VA4140-6ED34-0AA0
45	3VA4145-4ED34-0AA0	3VA4145-5ED34-0AA0	3VA4145-6ED34-0AA0
50	3VA4150-4ED34-0AA0	3VA4150-5ED34-0AA0	3VA4150-6ED34-0AA0
60	3VA4160-4ED34-0AA0	3VA4160-5ED34-0AA0	3VA4160-6ED34-0AA0
70	3VA4170-4ED34-0AA0	3VA4170-5ED34-0AA0	3VA4170-6ED34-0AA0
80	3VA4180-4ED34-0AA0	3VA4180-5ED34-0AA0	3VA4180-6ED34-0AA0
90	3VA4190-4ED34-0AA0	3VA4190-5ED34-0AA0	3VA4190-6ED34-0AA0
100	3VA4110-4ED34-0AA0	3VA4110-5ED34-0AA0	3VA4110-6ED34-0AA0
110	3VA4111-4ED34-0AA0	3VA4111-5ED34-0AA0	3VA4111-6ED34-0AA0
125	3VA4112-4ED34-0AA0	3VA4112-5ED34-0AA0	3VA4112-6ED34-0AA0



3VA41 125A 3-Pole

Trip Settings for 3VA41

TM210 - FTFM		
I, (A)	I, (A)	I, (A)
15	15	300
20	20	300
25	25	300
30	30	300
35	35	350
40	40	400
45	45	450
50	50	500
60	60	600
70	70	700
80	80	800
90	90	900
100	100	1000
110	110	1100
125	125	1250

Interrupting Ratings for 3VA41

Interrupting Class	Breaker Type	Poles	RMS Symmetrical Amperes (kA)						
			Volts AC (50/60 Hz)						
			120	240	277	347	480Y/277V	480	600Y/347V
S	SEAB	1	65		25	14			
		2, 3		65				25	25
M	MEAB	1	85		35	18			
		2, 3		85				35	35
H	HEAB	1	150		65	25			
		2, 3		150				65	65

Dimensions

Shipping Weight

Breaker	Poles	W in. (mm)	H in. (mm)	D in. (mm)	lbs.	kg
3VA41	1	1 (25.4)	5.1 (129.4)	3.6 (92.2)	0.62	0.28
3VA41	1 in 2	2 (50.8)	5.1 (129.4)	3.6 (92.2)	0.94	0.43
3VA41	2	2 (50.8)	5.1 (129.4)	3.6 (92.2)	1.13	0.51
3VA41	3	3 (76.2)	5.1 (129.4)	3.6 (92.2)	1.64	0.74

Connectors for 75C Wire for 3VA41

Type	Min. cable size	Max. cable size	Catalog No. (kit of 3 lugs)
Steel wrap around (Cu cable only), 1 cable lugs	AWG 14	3/0	3VA9133-0JA11
Aluminum body lug small (Cu/Al cable), 1 cable lug	AWG 14	AWG 10	3VA9133-0JB10
Aluminum body lug (Cu/Al cable), 1 cable lugs	AWG 14	3/0	3VA9133-0JB11
Aluminum body lug small with control wire tap (Cu/Al cable), 1 cable lug	AWG 14	AWG 10	3VA9133-0JG10
Aluminum body lug with control wire tap (Cu/Al cable), 1 cable lugs	AWG 14	3/0	3VA9133-0JG11
Copper body lug small (Cu cable only), 1 cable lugs	AWG 14	AWG 10	3VA9133-0JD10
Copper body lug (Cu cable only), 1 cable lugs	AWG 14	2/0	3VA9133-0JD11
Copper body lug small with control wire tap (Cu cable only), 1 cable lugs	AWG 14	AWG 10	3VA9133-0JK10
Copper body lug with control wire tap (Cu cable only), 1 cable lugs	AWG 14	2/0	3VA9133-0JK11

3VA4 Accessories

Description	Catalog Number
Padlocking Device for 3VA4 breaker	3VA9038-0LB11

Internal accessories configuration	3VA4/3VA5 125 A 1 in 2-pole /2-pole		3VA4 125 A 3-pole	
	Slot No.:	23 22 21	23 22 21	11 12 13
Auxiliary switch	Type			
	AUX_HQ	x x x	x x x	x x x
	AUX_HQ_el	x x x	x x x	x x x
Leading changeover switch	Type			
	LCS_HQ			
	LCS_HQ_el			
Alarm switch	Type			
	TAS_HQ	x x x	x x x	x x x
	TAS_HQ_el	x x x	x x x	x x x
Short circuit alarm switch	Type			
	SAS_HQ	x	x	x
	SAS_HQ_el			
Auxiliary release	Type			
	STF	x	x	x
	STL	x	x	x
Residual current release	Type			
	UNI	x	x	x
Other	Type			
	Cylinder lock (type Ronis)			x

Molded Case Circuit Breakers

3VA41 125A Thermal-magnetic Trip Circuit Breakers

Selection

3VA41 125A Frame, 1-Pole Thermal-Magnetic Trip Unit

Cont. Ampere Rating	S-Interrupting Class (SEAB)	M-Interrupting Class (MEAB)	H-Interrupting Class (HEAB)
	Catalog Number	Catalog Number	Catalog Number
TM210 FTFM			
15	3VA4195-4ED14-0AA0	3VA4195-5ED14-0AA0	3VA4195-6ED14-0AA0
20	3VA4120-4ED14-0AA0	3VA4120-5ED14-0AA0	3VA4120-6ED14-0AA0
25	3VA4125-4ED14-0AA0	3VA4125-5ED14-0AA0	3VA4125-6ED14-0AA0
30	3VA4130-4ED14-0AA0	3VA4130-5ED14-0AA0	3VA4130-6ED14-0AA0
35	3VA4135-4ED14-0AA0	3VA4135-5ED14-0AA0	3VA4135-6ED14-0AA0
40	3VA4140-4ED14-0AA0	3VA4140-5ED14-0AA0	3VA4140-6ED14-0AA0
45	3VA4145-4ED14-0AA0	3VA4145-5ED14-0AA0	3VA4145-6ED14-0AA0
50	3VA4150-4ED14-0AA0	3VA4150-5ED14-0AA0	3VA4150-6ED14-0AA0
60	3VA4160-4ED14-0AA0	3VA4160-5ED14-0AA0	3VA4160-6ED14-0AA0
70	3VA4170-4ED14-0AA0	3VA4170-5ED14-0AA0	3VA4170-6ED14-0AA0
80	3VA4180-4ED14-0AA0	3VA4180-5ED14-0AA0	3VA4180-6ED14-0AA0
90	3VA4190-4ED14-0AA0	3VA4190-5ED14-0AA0	3VA4190-6ED14-0AA0
100	3VA4110-4ED14-0AA0	3VA4110-5ED14-0AA0	3VA4110-6ED14-0AA0
110	3VA4111-4ED14-0AA0	3VA4111-5ED14-0AA0	3VA4111-6ED14-0AA0
125	3VA4112-4ED14-0AA0	3VA4112-5ED14-0AA0	3VA4112-6ED14-0AA0



3VA41 125A 1-Pole

3VA41 125A Frame, 1 in 2-Pole Thermal-Magnetic Trip Unit

Cont. Ampere Rating	S-Interrupting Class (SEAB)	M-Interrupting Class (MEAB)	H-Interrupting Class (HEAB)
	Catalog Number	Catalog Number	Catalog Number
TM210 FTFM [®]			
15	3VA4195-4ED54-0AA0	3VA4195-5ED54-0AA0	3VA4195-6ED54-0AA0
20	3VA4120-4ED54-0AA0	3VA4120-5ED54-0AA0	3VA4120-6ED54-0AA0
25	3VA4125-4ED54-0AA0	3VA4125-5ED54-0AA0	3VA4125-6ED54-0AA0
30	3VA4130-4ED54-0AA0	3VA4130-5ED54-0AA0	3VA4130-6ED54-0AA0
35	3VA4135-4ED54-0AA0	3VA4135-5ED54-0AA0	3VA4135-6ED54-0AA0
40	3VA4140-4ED54-0AA0	3VA4140-5ED54-0AA0	3VA4140-6ED54-0AA0
45	3VA4145-4ED54-0AA0	3VA4145-5ED54-0AA0	3VA4145-6ED54-0AA0
50	3VA4150-4ED54-0AA0	3VA4150-5ED54-0AA0	3VA4150-6ED54-0AA0
60	3VA4160-4ED54-0AA0	3VA4160-5ED54-0AA0	3VA4160-6ED54-0AA0
70	3VA4170-4ED54-0AA0	3VA4170-5ED54-0AA0	3VA4170-6ED54-0AA0
80	3VA4180-4ED54-0AA0	3VA4180-5ED54-0AA0	3VA4180-6ED54-0AA0
90	3VA4190-4ED54-0AA0	3VA4190-5ED54-0AA0	3VA4190-6ED54-0AA0
100	3VA4110-4ED54-0AA0	3VA4110-5ED54-0AA0	3VA4110-6ED54-0AA0
110	3VA4111-4ED54-0AA0	3VA4111-5ED54-0AA0	3VA4111-6ED54-0AA0
125	3VA4112-4ED54-0AA0	3VA4112-5ED54-0AA0	3VA4112-6ED54-0AA0



3VA41 125A 1 in 2-Pole

3VA41 125A Frame, 2-Pole Thermal-Magnetic Trip Unit

Cont. Ampere Rating	S-Interrupting Class (SEAB)	M-Interrupting Class (MEAB)	H-Interrupting Class (HEAB)
	Catalog Number	Catalog Number	Catalog Number
TM210 FTFM			
15	3VA4195-4ED24-0AA0	3VA4195-5ED24-0AA0	3VA4195-6ED24-0AA0
20	3VA4120-4ED24-0AA0	3VA4120-5ED24-0AA0	3VA4120-6ED24-0AA0
25	3VA4125-4ED24-0AA0	3VA4125-5ED24-0AA0	3VA4125-6ED24-0AA0
30	3VA4130-4ED24-0AA0	3VA4130-5ED24-0AA0	3VA4130-6ED24-0AA0
35	3VA4135-4ED24-0AA0	3VA4135-5ED24-0AA0	3VA4135-6ED24-0AA0
40	3VA4140-4ED24-0AA0	3VA4140-5ED24-0AA0	3VA4140-6ED24-0AA0
45	3VA4145-4ED24-0AA0	3VA4145-5ED24-0AA0	3VA4145-6ED24-0AA0
50	3VA4150-4ED24-0AA0	3VA4150-5ED24-0AA0	3VA4150-6ED24-0AA0
60	3VA4160-4ED24-0AA0	3VA4160-5ED24-0AA0	3VA4160-6ED24-0AA0
70	3VA4170-4ED24-0AA0	3VA4170-5ED24-0AA0	3VA4170-6ED24-0AA0
80	3VA4180-4ED24-0AA0	3VA4180-5ED24-0AA0	3VA4180-6ED24-0AA0
90	3VA4190-4ED24-0AA0	3VA4190-5ED24-0AA0	3VA4190-6ED24-0AA0
100	3VA4110-4ED24-0AA0	3VA4110-5ED24-0AA0	3VA4110-6ED24-0AA0
110	3VA4111-4ED24-0AA0	3VA4111-5ED24-0AA0	3VA4111-6ED24-0AA0
125	3VA4112-4ED24-0AA0	3VA4112-5ED24-0AA0	3VA4112-6ED24-0AA0



3VA41 125A 2-Pole

Ordering Information

The catalog numbers listed here are for complete, non-interchangeable trip circuit breakers with load lugs installed.

All 3VA41 thermal-magnetic trip circuit breakers are UL Listed and CSA Certified for reverse feed applications.

For NAVAL-rated 1, 2 or 3-P thermal-magnetic trip circuit breakers, change the 13th digit of the catalog number to the number "1". (For example, a 18KA @ 600/347VAC, 40A, 3-pole, NAVAL rated 3VA41 would be catalog number 3VA4140-5ED31-1AA0)

Circuit Breakers

Lug-In/Lug-Out with INSTA-WIRE

Selection

All BQ/BQH/HBQ circuit breakers are supplied with load side lugs. If line side lugs are required, add suffix "L" to catalog number. Consult Siemens for any additional charge. All standard circuit breakers are calibrated for 40°C maximum ambient application.

Continuous Current Rating @ 40° C	Type BQ ^①	Type BQH	Type HBQ
	10,000A IR Catalogue Number	22,000A IR Catalogue Number	65,000A IR Catalogue Number

1-Pole (120V AC)^②

Rating	Type BQ ^①	Type BQH	Type HBQ
15	BQ1B015 ^{③④}	BQ1B015H ^④	HB1B015 ^④
20	BQ1B020 ^{③④}	BQ1B020H ^④	HB1B020 ^④
25	BQ1B025	BQ1B025H	HB1B025
30	BQ1B030	BQ1B030H	HB1B030
35	BQ1B035	BQ1B035H	HB1B035
40	BQ1B040	BQ1B040H	HB1B040
45	BQ1B045	—	HB1B045
50	BQ1B050	BQ1B050H	HB1B050
60	BQ1B060 ^⑤	BQ1B060H	HB1B060
70	BQ1B070	BQ1B070H	HB1B070

2-Pole (Common-Trip 120/240V AC)^②

Rating	Type BQ ^①	Type BQH	Type HBQ
15	BQ2B015	BQ2B015H	HB2B015
20	BQ2B020	BQ2B020H	HB2B020
25	BQ2B025	BQ2B025H	HB2B025
30	BQ2B030	BQ2B030H	HB2B030
35	BQ2B035	BQ2B035H	HB2B035
40	BQ2B040	BQ2B040H	HB2B040
45	BQ2B045	—	HB2B045
50	BQ2B050	BQ2B050H	HB2B050
60	BQ2B060 ^⑤	BQ2B060H	HB2B060
70	BQ2B070	BQ2B070H	HB2B070
80	BQ2B080	BQ2B080H	HB2B080
90	BQ2B090	BQ2B090H	HB2B090
100	BQ2B100	BQ2B100H	HB2B100
110	BQ2B110	—	HB2B110
125	BQ2B125	BQ2B125H	HB2B125

2-Pole (Common-Trip 240V AC)^{③⑥}

Rating	Type BQ ^①	Type BQH	Type HBQ
15	BQ2H015	—	—
20	BQ2H020	—	—
30	BQ2H030	—	—
40	BQ2H040	—	—
50	BQ2H050	—	—
60	BQ2H060	—	—
70	BQ2H070	—	—
80	BQ2H080	—	—
90	BQ2H090	—	—
100	BQ2H100	—	—

3-Pole (Common-Trip 240V AC)^②

Rating	Type BQ ^①	Type BQH	Type HBQ
15	BQ3B015	BQ3B015H	HB3B015
20	BQ3B020	BQ3B020H	HB3B020
25	BQ3B025	BQ3B025H	HB3B025
30	BQ3B030	BQ3B030H	HB3B030
35	BQ3B035	BQ3B035H	HB3B035
40	BQ3B040	BQ3B040H	HB3B040
45	BQ3B045	BQ3B045H	HB3B045
50	BQ3B050	BQ3B050H	HB3B050
60	BQ3B060	BQ3B060H	HB3B060
70	BQ3B070	BQ3B070H	HB3B070
80	BQ3B080	BQ3B080H	HB3B080
90	BQ3B090	BQ3B090H	HB3B090
100	BQ3B100	BQ3B100H	HB3B100

BQ / BQH / HBQ Internal Accessories

Description	Catalogue Number	Field/Factory Installed
120VAC Shunt Trip	add suffix...00S01	Factory
24VAC Shunt Trip	add suffix...00S07	Factory
120V Auxiliary Switch	add suffix...01 ^⑦	Factory

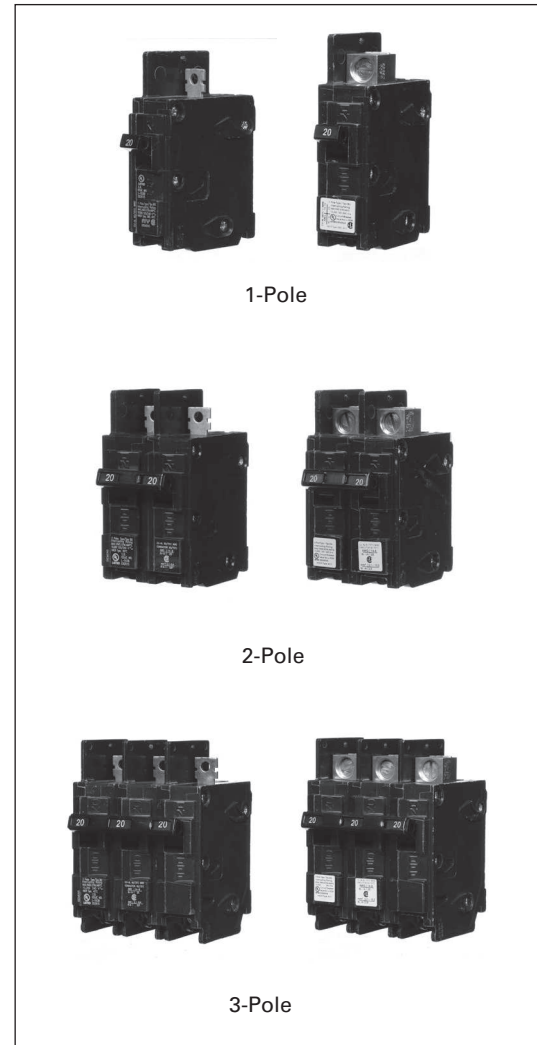

Factory Modifications

Description	Catalogue Number
Line Side Lugs	add suffix...L
Quick Connect Lug	add suffix...QX
400Hz Calibration	add suffix...Y ^⑧
Marine 50° C Ambient Calibration	add suffix...M
Fungus Proofing	add suffix...F

■ Built to order. Allow 2-3 weeks for delivery

① CSA Certified / UL Listed for use with 60/75° wire through 40 amps, CSA Certified / UL Listed for use with 75° wire only for 50 amps and above, HACR rated.
② 1A and 1B contacts.

③ CSA Certified / UL Listed for use on 3-phase grounded "B" systems — 10,000 for this application.
④ CSA Certified / UL Listed for frequent switching applications (SWD). 120V AC Fluorescent Lighting.
⑤ Shipped 12 per sleeve.
⑥ Shipped 6 per sleeve.

⑦ Shipped 4 per sleeve.
⑧ CSA Certified / UL Listed 5KA IR.
⑨ Refer to Table A on page 5-86
⑩ CSA Certified for frequent switching applications (SWD)

For external accessories, please refer to page 5-154 - 5-159

Molded Case Circuit Breakers

DIN Rail Mounted Circuit Breakers

Selection/Dimensions

Breaker Type	Ampere Rating	Catalog Number	Line Side Connector	Load Side Connector	Interrupting Ratings (KA) (RMS Symmetrical Amperes) Volts AC	
					120	120/240

1-Pole DIN Rail (120V AC)

BQLD 1-Pole 120V DIN Rail	10	BQ1B010QLD	TC1Q1	TC1Q1	10	
	15	BQ1B015QLD	TC1Q1	TC1Q1	10	
	20	BQ1B020QLD	TC1Q1	TC1Q1	10	
	25	BQ1B025QLD	TC1Q1	TC1Q1	10	
	30	BQ1B030QLD	TC1Q1	TC1Q1	10	
	35	BQ1B035QLD	TC1Q1	TC1Q1	10	
	40	BQ1B040QLD	TC1Q1	TC1Q1	10	
BOXD 1-Pole 120V DIN Rail	45	BQ1B045QLD	TA1Q1	TA1Q1	10	
	50	BQ1B050QLD	TA1Q1	TA1Q1	10	
	60	BQ1B060QLD	TA1Q1	TA1Q1	10	
	10	BQ1B010QXD	TC1Q1	Quick-Connect	10	
	15	BQ1B015QXD	TC1Q1	Quick-Connect	10	
	20	BQ1B020QXD	TC1Q1	Quick-Connect	10	
	25	BQ1B025QXD	TC1Q1	Quick-Connect	10	
BOXD 1-Pole 120V DIN Rail	30	BQ1B030QXD	TC1Q1	Quick-Connect	10	
	35	BQ1B035QXD	TC1Q1	Quick-Connect	10	
	40	BQ1B040QXD	TC1Q1	Quick-Connect	10	
	45	BQ1B045QXD	TA1Q1	Quick-Connect	10	
	50	BQ1B050QXD	TA1Q1	Quick-Connect	10	
	60	BQ1B060QXD	TA1Q1	Quick-Connect	10	

2-Pole DIN Rail (120/240V AC)

BQLD 2-Pole 120/240V DIN Rail	10	BQ2B010QLD	TC1Q1	TC1Q1		10
	15	BQ2B015QLD	TC1Q1	TC1Q1		10
	20	BQ2B020QLD	TC1Q1	TC1Q1		10
	25	BQ2B025QLD	TC1Q1	TC1Q1		10
	30	BQ2B030QLD	TC1Q1	TC1Q1		10
	35	BQ2B035QLD	TC1Q1	TC1Q1		10
	40	BQ2B040QLD	TC1Q1	TC1Q1		10
BOXD 2-Pole 120/240V DIN Rail	45	BQ2B045QLD	TA1Q1	TA1Q1		10
	50	BQ2B050QLD	TA1Q1	TA1Q1		10
	60	BQ2B060QLD	TA1Q1	TA1Q1		10
	10	BQ2B010QXD	TC1Q1	Quick-Connect		10
	15	BQ2B015QXD	TC1Q1	Quick-Connect		10
	20	BQ2B020QXD	TC1Q1	Quick-Connect		10
	25	BQ2B025QXD	TC1Q1	Quick-Connect		10
BOXD 2-Pole 120/240V DIN Rail	30	BQ2B030QXD	TC1Q1	Quick-Connect		10
	35	BQ2B035QXD	TC1Q1	Quick-Connect		10
	40	BQ2B040QXD	TC1Q1	Quick-Connect		10
	45	BQ2B045QXD	TA1Q1	Quick-Connect		10
	50	BQ2B050QXD	TA1Q1	Quick-Connect		10
	60	BQ2B060QXD	TA1Q1	Quick-Connect		10

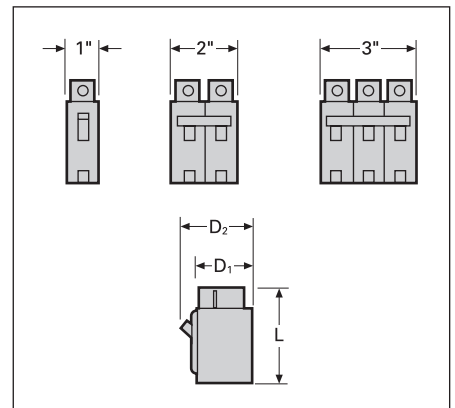
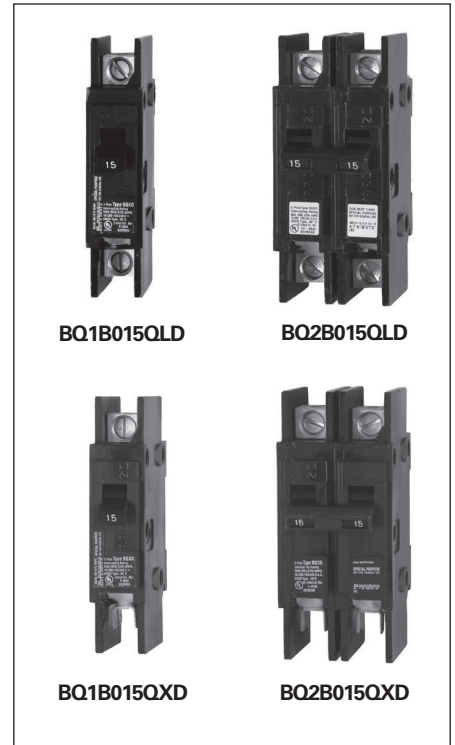

Lugs-For Use with BOXD^⑥

Circuit Breaker Amp. Rtg.	Cab. Per Lug	Lug Wire Range AWG	Catalogue Number
Line Side			
10-40	1	#16-#6 Cu #12-#6 Al	TC1Q1 ^{①②}
45-125	1000	#8-#1 Cu #6-#1/0 Al	TA1Q1

Finger Safe Terminal Shield

Protects against accidental contact with lugs-1 per lug. Fits line and load end.

Catalogue Number	Qty
BQFS2	2
BQFS1K	1000

Breaker Type	Amperes	Dimensions (inches)		
		L	D1	D2
BQ, BQH	15-50	3 ³ / ₄	2 ³ / ₈	3
BQ, BQH	55-125	4	2 ³ / ₈	3
HBQ	15-125	4	2 ³ / ₈	3
BQXD	15-60	4 ¹ / ₂	2 ³ / ₈	3

Enclosures page 5-139 – 5-146
Accessories pages 5-151 - 5-159

For inches / millimeters conversion, see Technical section.

■ Built to order. Allow 2-3 weeks for delivery.

① CSA Certified / UL Listed for use with 60/75° wire through 40 amps, CSA Certified / UL listed for use with 75° wire only for 50 amps and above, HACR rated.

② Connector has steel construction.

③ Surface mounted indoor. If flush mounting is required, replace suffix "S" in catalog number with suffix "F".

④ Neutral included in enclosure.

⑤ Enclosure will not accept circuit breakers with shunt trips or auxiliary switches installed.

⑥ Type BOXD uses TA1Q1 or TC1Q1 lugs on line side of circuit breaker.

Molded Case Circuit Breakers

QR 250A Frame

Selection/Dimensions

Continuous Current Rating @ 40°C	2-Pole 240V AC Catalog Number	3-Pole 240V AC Catalog Number
----------------------------------	-------------------------------	-------------------------------

Type QR2^②

100	QR22B100	QR23B100
125	QR22B125	QR23B125
150	QR22B150	QR23B150
175	QR22B175	QR23B175
200	QR22B200	QR23B200
225	QR22B225	QR23B225
250	QR22B250	QR23B250

Type QRH2^②

100	QRH22B100■	QRH23B100
125	QRH22B125	QRH23B125
150	QRH22B150	QRH23B150
175	QRH22B175■	QRH23B175
200	QRH22B200	QRH23B200
225	QRH22B225	QRH23B225
250	QRH22B250	QRH23B250

Type HQR2^②

100	HQR22B100■	HQR23B100
125	HQR22B125	HQR23B125
150	HQR22B150	HQR23B150
175	HQR22B175■	HQR23B175
200	HQR22B200	HQR23B200
225	HQR22B225	HQR23B225
250	HQR22B250	HQR23B250

Type HQR2H^②

100	HQR22B100H	HQR23B100H
125	HQR22B125H	HQR23B125H
150	HQR22B150H	HQR23B150H
175	HQR22B175H	HQR23B175H
200	HQR22B200H	HQR23B200H
225	HQR22B225H	HQR23B225H
250	HQR22B250H	HQR23B250H

Ordering Information

Load side 3TA1QR300 lugs are mounted and included when circuit breaker is ordered. For line and load lugs (3TA1QR300) installed at no additional charge, add suffix "L" to catalog number.

50°C Calibration - See page 5-160.
400HZ. - See page 5-160.

Shipping Weights

Number of Poles	Number per Carton	Shipping Weight (lbs.)
2	1	3.2
3	1	4.5

Lugs For 75°C Wire^①

Catalog Number	Lug Body	Lug Wire Range
3TA1QR300	Al	#3 - 300 Kcmil Al/Cu
3TC1QR250	Cu	#3 - 300 Kcmil Cu ONLY

CSA C22.2 No. 5 / UL 489

Interrupting Ratings

Breaker Type	RMS Symmetrical Amperes (kA) Volts AC (50/60 Hz)
	240
QR2	10
QRH2	25
HQR2	65
HQR2H	100

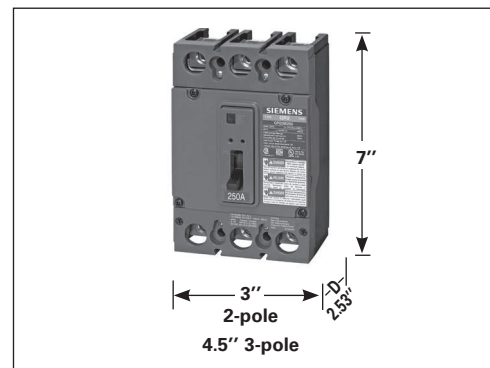

For external accessories, please refer to pages 5-154 - 5-159. For internal accessories, please refer to page 5-151 - 5-153.

■ Built to order. Allow 2-3 weeks for delivery.

① See **Note: A** page 5-147.

② HACR rated.

Note: Suitable for reverse feed applications

Molded Case Circuit Breakers

CQD 100A Frame

Selection/Dimensions

Type CQD (Cable In - Cable Out) DIN Rail Mount^③

Continuous Current Rating @ 40°C	1-Pole	2-Pole	3-Pole
	277V AC 125V DC	480Y/277V AC 125/250V DC	480Y/277V AC
	Catalog Number	Catalog Number	Catalog Number
15	CQD115 ^{①②}	CQD215 ^②	CQD315 ^②
20	CQD120 ^{①②}	CQD220 ^②	CQD320 ^②
25	CQD125 ^②	CQD225 ^②	CQD325 ^②
30	CQD130 ^②	CQD230 ^②	CQD330 ^②
35	CQD135 ^② ■	CQD235 ^② ■	CQD335 ^②
40	CQD140 ^② ■	CQD240 ^②	CQD340 ^②
45	CQD145 ^② ■	CQD245 ^② ■	CQD345 ^② ■
50	CQD150 ^② ■	CQD250 ^②	CQD350 ^②
60	CQD160■	CQD260	CQD360
70	CQD170■	CQD270	CQD370
80	CQD180■	CQD280	CQD380
90	CQD190■	CQD290■	CQD390
100	CQD1100■	CQD2100	CQD3100

Shipping Weights

Number of Poles	Number per Carton	Shipping Weight lbs. (kg)
1	1	0.5 (0)
2	1	1.0 (0)
3	1	1.5 (1)

Lugs For 60/75°C Wire

Amps	Wire Size
15-40	#14-#6 AWG Cu #12-#6 AWG Al
45-100	#8-#1 AWG Cu #8-#1/0 AWG Al

Interrupting Ratings

Breaker Type	Number of Poles	RMS Symmetrical Amperes (KA)						
		Volts AC					Volts DC	
		120	240	277	480/277	600/277	125	125/250
CQD (CSA/UL)	1	65	—	14	—	—	14	—
	2	—	65	—	14	—	—	14
	3	—	65	—	14	—	—	—

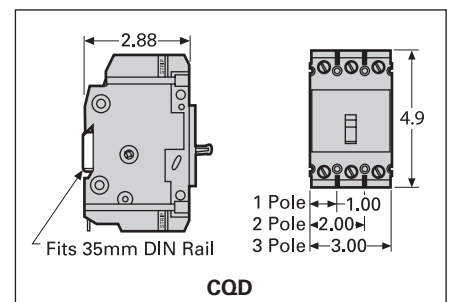
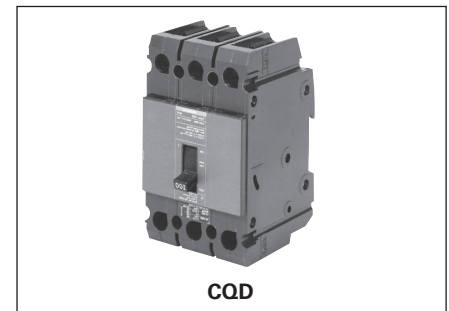

For inches / millimeters conversion, see Technical section.

■ Built to order. Allow 2-3 weeks for delivery.

① SWD rated.

Note: Suitable for reverse feed applications

② HID rated.

③ HACR rated.

Enclosures page 5-139 – 5-146
Accessories pages 5-151 - 5-159

Molded Case Circuit Breakers

GG 125A Frame

Selection/Dimensions

GG 125A Frame (Cable In - Cable Out)

Continuous Current Rating @ 40°C	1-Pole	2-Pole	3-Pole
	Catalog Number	Catalog Number	Catalog Number
15	NGG1B015L ^{①②}	NGG2B015L ^②	NGG3B015L ^②
20	NGG1B020L ^{①②}	NGG2B020L ^②	NGG3B020L ^②
25	NGG1B025L ^②	NGG2B025L ^②	NGG3B025L ^②
30	NGG1B030L ^②	NGG2B030L ^②	NGG3B030L ^②
35	NGG1B035L ^②	NGG2B035L ^②	NGG3B035L ^②
40	NGG1B040L ^②	NGG2B040L ^②	NGG3B040L ^②
45	NGG1B045L ^②	NGG2B045L ^②	NGG3B045L ^②
50	NGG1B050L ^②	NGG2B050L ^②	NGG3B050L ^②
60	NGG1B060L	NGG2B060L	NGG3B060L
70	NGG1B070L	NGG2B070L	NGG3B070L
80	NGG1B080L	NGG2B080L	NGG3B080L
90	NGG1B090L	NGG2B090L	NGG3B090L
100	NGG1B100L	NGG2B100L	NGG3B100L
110	NGG1B110L	NGG2B110L	NGG3B110L
125	NGG1B125L	NGG2B125L	NGG3B125L



GG

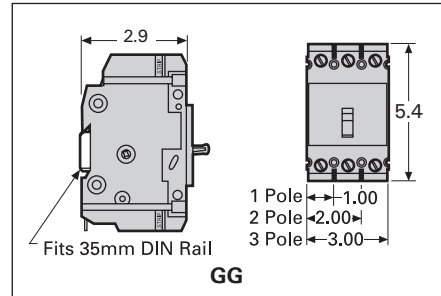

GG

Line and load lugs are included as standard. If no lugs are required, remove the "L" suffix. HACR rated. Suitable for screws or DIN rail mounting.

Type HGG (Cable In - Cable Out)

Continuous Current Rating @ 40°C	1-Pole	2-Pole	3-Pole
	Catalog Number	Catalog Number	Catalog Number
15	HGG1B015L ^{①②}	HGG2B015L ^②	HGG3B015L ^②
20	HGG1B020L ^{①②}	HGG2B020L ^②	HGG3B020L ^②
25	HGG1B025L ^②	HGG2B025L ^②	HGG3B025L ^②
30	HGG1B030L ^②	HGG2B030L ^②	HGG3B030L ^②
35	HGG1B035L ^②	HGG2B035L ^②	HGG3B035L ^②
40	HGG1B040L ^②	HGG2B040L ^②	HGG3B040L ^②
45	HGG1B045L ^②	HGG2B045L ^②	HGG3B045L ^②
50	HGG1B050L ^②	HGG2B050L ^②	HGG3B050L ^②
60	HGG1B060L	HGG2B060L	HGG3B060L
70	HGG1B070L	HGG2B070L	HGG3B070L
80	HGG1B080L	HGG2B080L	HGG3B080L
90	HGG1B090L	HGG2B090L	HGG3B090L
100	HGG1B100L	HGG2B100L	HGG3B100L
110	HGG1B110L	HGG2B110L	HGG3B110L
125	HGG1B125L	HGG2B125L	HGG3B125L

Type LGG (Cable In - Cable Out)

Continuous Current Rating @ 40°C	1-Pole	2-Pole	3-Pole
	Catalog Number	Catalog Number	Catalog Number
15	LGG1B015L ^{①②}	LGG2B015L ^②	LGG3B015L ^②
20	LGG1B020L ^{①②}	LGG2B020L ^②	LGG3B020L ^②
25	LGG1B025L ^②	LGG2B025L ^②	LGG3B025L ^②
30	LGG1B030L ^②	LGG2B030L ^②	LGG3B030L ^②
35	LGG1B035L ^②	LGG2B035L ^②	LGG3B035L ^②
40	LGG1B040L ^②	LGG2B040L ^②	LGG3B040L ^②
45	LGG1B045L ^②	LGG2B045L ^②	LGG3B045L ^②
50	LGG1B050L ^②	LGG2B050L ^②	LGG3B050L ^②
60	LGG1B060L	LGG2B060L	LGG3B060L
70	LGG1B070L	LGG2B070L	LGG3B070L
80	LGG1B080L	LGG2B080L	LGG3B080L
90	LGG1B090L	LGG2B090L	LGG3B090L
100	LGG1B100L	LGG2B100L	LGG3B100L
110	LGG1B110L	LGG2B110L	LGG3B110L
125	LGG1B125L	LGG2B125L	LGG3B125L

5 MOLDED CASE CIRCUIT BREAKERS

Shipping Weights

Number of Poles	Number per Carton	Shipping Weight lbs. (kg)
1	1	0.75 (0.34)
2	1	1.3 (0.59)
3	1	2.0 (0.98)

Lugs For 60/75°C Wire

NGG		
Ampere Rating	Wire Size	Catalogue Number
15-30A	#14-#6 AWG Cu	TC1Q1 (qty. 1)
	#12-#6 AWG Al	3TC1Q1 (qty. 3)
35-125A	#8-1/0 AWG Cu #8-2/0 AWG Al	3TC1GG20 (qty. 3)
15-125A	Nut Keeper plate w/ screw (for crimp terminals)	TNKG3 (qty. 3)

Interrupting Ratings (max. RMS symmetrical amperes kA)

Breaker Type	Poles	CSA 22.2 No. 5 / UL 489								IEC 60947-2 (Ics = 50%Icu)		
		Volts AC								Volts DC		
		120	240	277	347	480	600Y/347	125	125/250	240	415	125/250
NGG	1	65	—	25	14	—	—	14	—	25	—	—
	2,3	—	65	—	—	25	14	—	14 ^①	65	—	14
HGG	1	85	—	35	14	—	—	14	—	—	—	—
	2,3	—	85	—	—	35	14	—	14 ^①	—	—	—
LGG	1	100	—	65	14	—	—	14	—	—	—	—
	2,3	—	100	—	—	65	14	—	14 ^①	—	—	—

For inches / millimeters conversion, see Technical section.

① HID rated at 15-50A 1-pole @ 277 VAC; 2 & 3-pole @ 480 VAC

Enclosures page 5-139 - 5-146
Accessories pages 5-151 - 5-159

Molded Case Circuit Breakers

Accessories

Selection

Shunt Trip

Control Voltage		BQD, BQD6, CQD, NGG, HGG, LGG, NGB, HGB and LGB Catalog Number
V AC	V DC	
120	—	CQDST120
240	—	CQDST240▲
277	—	CQDST277▲
480	—	CQDST480▲
600	—	CQDST600
—	12	CQDST12
—	24	CQDST24
—	48	CQDST48
—	125	CQDST125

Auxiliary Switch

Maximum Voltage		Number of Contacts	BQD, BQD6, CQD, NGG, HGG, LGG, NGB, HGB and LGB Catalog Number
AC	DC		
240	125	1A-1B	CQDA1
240	125	2A-2B	CQDA2

Alarm Switch

Maximum Voltage		BQD, BQD6, CQD, NGG, HGG, LGG, NGB, HGB and LGB Catalog Number
AC	DC	
240	125	CQDBA

Shunt Trip and Auxiliary Switch Combinations

Shunt Trip Voltage		BQD, BQD6, CQD, NGG, HGG, LGG, NGB, HGB and LGB Catalog Number
AC	DC	
24	—	CQDST24AAS▲
120	—	CQDST120AAS▲
240	—	CQDST240AAS▲
277	—	CQDST277AAS▲
480	—	CQDST480AAS▲
600	—	CQDST600AAS▲
—	12	CQDST12DAS▲
—	24	CQDST24DAS▲
—	48	CQDST48DAS▲
—	125	CQDST125DAS▲

Alarm and Auxiliary Switch Combinations

For Breaker	Catalog Number
BQD, BQD6, CQD, NGG, HGG, LGG, NGB, HGB and LGB	CQDA1BA▲



CQDST120AAS

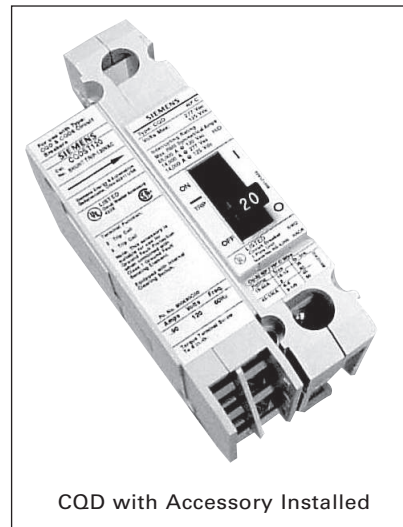

CQD with Accessory Installed

▲ Built to order. Allow 6-8 weeks for delivery.

Ⓞ Adds 1-pole space for accessory.

Molded Case Circuit Breakers

3VA CSA / UL Circuit Breakers

Catalog Numbering System

Catalogue Numbering Logic



Breaker Designation	
Thermal magnetic panelboard breakers	4
Thermal magnetic (Cable-in Cable-out) breakers	5
Electronic trip breakers	6

Frame Size	
125/150A	1
250A	2
400A	3
600A	4
800A	5
1000A	6

Rated Current											
3VA41/ 3VA51	3VA52	3VA53	3VA54	3VA55	3VA61	3VA62	3VA63	3VA64	3VA65	3VA66	
15A											95
20A	200A	200A									20
	225A	225A									22
25A	250A	250A				250A	250A				25
30A		300A									30
35A		350A									35
40A	40A	400A			40A		400A	400A			40
45A	45A		450A								45
50A	50A		500A								50
60A	60A		600A	600A				600A	600A		60
70A	70A			700A							70
80A	80A			800A					800A		80
90A	90A										90
100A	100A				100A	100A				1000A	10
110A	110A										11
125A	125A										12
	150A				150A						15
	175A										17

Interrupting Capacity @ 600V / 480V		
3VA4/3VA5	3VA6	
MCP/MCS	100K / 200K	0
MCP/MCS	MCP/MCS	1
14K / 25K		4
18K / 35K	18K / 35K	5
25K / 65K	22K / 65K	6
35K / 100K	35K / 100K	7
	50K / 150K	8

- Trip Unit Protection Functions (see next page for details)
- Number of Poles (see next page for details)
- Connection Technology (see next page for details)
- Regional Specifics (as applicable) (see next page for details)
- Auxiliary Releases (see next page for details)
- Auxiliary/Alarm Switches (see next page for details)

Molded Case Circuit Breakers

3VA CSA / UL Circuit Breakers

Catalog Numbering System

Catalogue Numbering Logic (cont.)

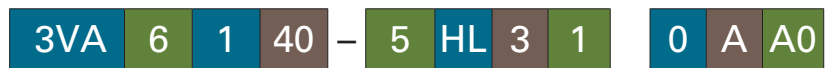

(see previous page for details)

Trip Unit Protection Functions											
3VA4/3VA5		L	I	N							
TM230	MCCB	fix	adj								EC
TM210	MCCB	fix	fix								ED
TM240	MCCB	adj	adj								EF
TM230	MCCB	fix	adj	100%							GC
TM210	MCCB	fix	fix	100%							GD
TM240	MCCB	adj	adj	100%							GF
TM110M	MSP		fix								MG
TM120M	MSP		adj								MH
TM120M	MSP		adj								MU
MCS110	MSC		fix								BB
3VA6		L	S	I	G	N	LCD	com.	measurement	values	
ETU320 LI	MCCB	adj		adj		0%/50%/100%					HL
ETU330 LIG	MCCB	adj		adj	adj	0%/50%/100%					HM
ETU350 LSI	MCCB	adj	adj	fix		0%/50%/100%					HN
ETU550 LSI	MCCB	adj	adj	adj		20/40%...100/160%	yes	yes	standard		JP
ETU556 LSI(G)	MCCB	adj	adj	adj	alarm	20/40%...100/160%	yes	yes	standard		JT
ETU560 LSIG	MCCB	adj	adj	adj	adj	20/40%...100/160%	yes	yes	standard		JQ
ETU820 LI	MCCB	adj		adj		20/40%...100/160%	yes	yes	advanced		KL
ETU830 LIG	MCCB	adj		adj	adj	20/40%...100/160%	yes	yes	advanced		KM
ETU850LSI	MCCB	adj	adj	adj		20/40%...100/160%	yes	yes	advanced		KP
ETU856 LSI(G)	MCCB	adj	adj	adj	alarm	20/40%...100/160%	yes	yes	advanced		KT
ETU860 LSIG	MCCB	adj	adj	adj	adj	20/40%...100/160%	yes	yes	advanced		KQ
ETU310M	MCP			adj							MS
MCS110	MCS			fix							BB

Number of Poles	
1 pole	1
2 pole	2
3 pole	3
4 pole	4
1-in-2 pole	5
2-in-3 pole	6

Connection Technology	
Blank, punched copper bar without any lugs	1
Nut keeper kit, line and load	2
Nut keeper kit, load end only	3
Aluminum wire connector, load end only	4
Wire connector, line end only	5
Wire connector, line and load	6

Regional Specifics (as applicable)	
Standard	0
NAVAL/50C	1
100% Rated (3VA6)	2

Auxiliary Releases	
Without	A

Auxiliary/Alarm Switches	
Without	A0

Molded Case Circuit Breakers

3VA51 125A Thermal-magnetic Trip Circuit Breakers

Selection

3VA51 125A Frame, 1-Pole Thermal-Magnetic Trip Unit

Cont. Ampere Rating	S-Interrupting Class (SEAS)	M-Interrupting Class (MEAS)	H-Interrupting Class (HEAS)
	Catalog Number	Catalog Number	Catalog Number
TM210 FTFM			
15	3VA5195-4ED11-0AA0	3VA5195-5ED11-0AA0	3VA5195-6ED11-0AA0
20	3VA5120-4ED11-0AA0	3VA5120-5ED11-0AA0	3VA5120-6ED11-0AA0
25	3VA5125-4ED11-0AA0	3VA5125-5ED11-0AA0	3VA5125-6ED11-0AA0
30	3VA5130-4ED11-0AA0	3VA5130-5ED11-0AA0	3VA5130-6ED11-0AA0
35	3VA5135-4ED11-0AA0	3VA5135-5ED11-0AA0	3VA5135-6ED11-0AA0
40	3VA5140-4ED11-0AA0	3VA5140-5ED11-0AA0	3VA5140-6ED11-0AA0
45	3VA5145-4ED11-0AA0	3VA5145-5ED11-0AA0	3VA5145-6ED11-0AA0
50	3VA5150-4ED11-0AA0	3VA5150-5ED11-0AA0	3VA5150-6ED11-0AA0
60	3VA5160-4ED11-0AA0	3VA5160-5ED11-0AA0	3VA5160-6ED11-0AA0
70	3VA5170-4ED11-0AA0	3VA5170-5ED11-0AA0	3VA5170-6ED11-0AA0
80	3VA5180-4ED11-0AA0	3VA5180-5ED11-0AA0	3VA5180-6ED11-0AA0
90	3VA5190-4ED11-0AA0	3VA5190-5ED11-0AA0	3VA5190-6ED11-0AA0
100	3VA5110-4ED11-0AA0	3VA5110-5ED11-0AA0	3VA5110-6ED11-0AA0
110	3VA5111-4ED11-0AA0	3VA5111-5ED11-0AA0	3VA5111-6ED11-0AA0
125	3VA5112-4ED11-0AA0	3VA5112-5ED11-0AA0	3VA5112-6ED11-0AA0



3VA51 125A 1-Pole

3VA51 125A Frame, 2-Pole Thermal-Magnetic Trip Unit

Cont. Ampere Rating	S-Interrupting Class (SEAS)	M-Interrupting Class (MEAS)	H-Interrupting Class (HEAS)
	Catalog Number	Catalog Number	Catalog Number
TM210 FTFM [Ⓞ]			
15	3VA5195-4ED21-0AA0	3VA5195-5ED21-0AA0	3VA5195-6ED21-0AA0
20	3VA5120-4ED21-0AA0	3VA5120-5ED21-0AA0	3VA5120-6ED21-0AA0
25	3VA5125-4ED21-0AA0	3VA5125-5ED21-0AA0	3VA5125-6ED21-0AA0
30	3VA5130-4ED21-0AA0	3VA5130-5ED21-0AA0	3VA5130-6ED21-0AA0
35	3VA5135-4ED21-0AA0	3VA5135-5ED21-0AA0	3VA5135-6ED21-0AA0
40	3VA5140-4ED21-0AA0	3VA5140-5ED21-0AA0	3VA5140-6ED21-0AA0
45	3VA5145-4ED21-0AA0	3VA5145-5ED21-0AA0	3VA5145-6ED21-0AA0
50	3VA5150-4ED21-0AA0	3VA5150-5ED21-0AA0	3VA5150-6ED21-0AA0
60	3VA5160-4ED21-0AA0	3VA5160-5ED21-0AA0	3VA5160-6ED21-0AA0
70	3VA5170-4ED21-0AA0	3VA5170-5ED21-0AA0	3VA5170-6ED21-0AA0
80	3VA5180-4ED21-0AA0	3VA5180-5ED21-0AA0	3VA5180-6ED21-0AA0
90	3VA5190-4ED21-0AA0	3VA5190-5ED21-0AA0	3VA5190-6ED21-0AA0
100	3VA5110-4ED21-0AA0	3VA5110-5ED21-0AA0	3VA5110-6ED21-0AA0
110	3VA5111-4ED21-0AA0	3VA5111-5ED21-0AA0	3VA5111-6ED21-0AA0
125	3VA5112-4ED21-0AA0	3VA5112-5ED21-0AA0	3VA5112-6ED21-0AA0



3VA51 125A 2-Pole

Ordering Information

The catalog numbers listed here are for complete, non-interchangeable trip circuit breakers without lugs.

Order required lugs or connection technology separately for field installation.

All 3VA51 thermal-magnetic trip circuit breakers are CSA approved and UL listed for reverse feed applications.

For NAVAL-rated thermal-magnetic trip circuit breakers, change the 13th digit of the catalog number to the number "1". (For example, a 18kA @600/347VAC, 40A, 3-pole, NAVAL rated 3VA51 would be catalog number 3VA5140-5ED31-1AA0)

Dimensions

Breaker	Poles	W in. (mm)	H in. (mm)	D in. (mm)	lbs.	kg
3VA51	1	1 (25.4)	5.5 (140)	3 (76.5)	0.84	0.38
3VA51	2	2 (50.8)	5.5 (140)	3 (76.5)	1.37	0.62
3VA51	3	3 (76.2)	5.5 (140)	3 (76.5)	1.73	0.78
3VA51	4	4 (101.6)	5.5 (140)	3 (76.5)	2.09	0.95

Shipping Weight

[Ⓞ] Available with NAVAL/50C ratings.

Molded Case Circuit Breakers

3VA51 125A Thermal-magnetic Trip Circuit Breakers

Selection

3VA51 125A Frame, 3-Pole Thermal-Magnetic Trip Unit

Cont. Ampere Rating	S-Interrupting Class (SEAS)	M-Interrupting Class (MEAS)	H-Interrupting Class (HEAS)
	Catalog Number	Catalog Number	Catalog Number
TM210 FTFM [Ⓞ]			
15	3VA5195-4ED31-0AA0	3VA5195-5ED31-0AA0	3VA5195-6ED31-0AA0
20	3VA5120-4ED31-0AA0	3VA5120-5ED31-0AA0	3VA5120-6ED31-0AA0
25	3VA5125-4ED31-0AA0	3VA5125-5ED31-0AA0	3VA5125-6ED31-0AA0
30	3VA5130-4ED31-0AA0	3VA5130-5ED31-0AA0	3VA5130-6ED31-0AA0
35	3VA5135-4ED31-0AA0	3VA5135-5ED31-0AA0	3VA5135-6ED31-0AA0
40	3VA5140-4ED31-0AA0	3VA5140-5ED31-0AA0	3VA5140-6ED31-0AA0
45	3VA5145-4ED31-0AA0	3VA5145-5ED31-0AA0	3VA5145-6ED31-0AA0
50	3VA5150-4ED31-0AA0	3VA5150-5ED31-0AA0	3VA5150-6ED31-0AA0
60	3VA5160-4ED31-0AA0	3VA5160-5ED31-0AA0	3VA5160-6ED31-0AA0
70	3VA5170-4ED31-0AA0	3VA5170-5ED31-0AA0	3VA5170-6ED31-0AA0
80	3VA5180-4ED31-0AA0	3VA5180-5ED31-0AA0	3VA5180-6ED31-0AA0
90	3VA5190-4ED31-0AA0	3VA5190-5ED31-0AA0	3VA5190-6ED31-0AA0
100	3VA5110-4ED31-0AA0	3VA5110-5ED31-0AA0	3VA5110-6ED31-0AA0
110	3VA5111-4ED31-0AA0	3VA5111-5ED31-0AA0	3VA5111-6ED31-0AA0
125	3VA5112-4ED31-0AA0	3VA5112-5ED31-0AA0	3VA5112-6ED31-0AA0

TM230 FTAM [Ⓞ]			
15	3VA5195-4EC31-0AA0	3VA5195-6EC31-0AA0	3VA5195-6EC31-0AA0
20	3VA5120-4EC31-0AA0	3VA5120-5EC31-0AA0	3VA5120-6EC31-0AA0
25	3VA5125-4EC31-0AA0	3VA5125-5EC31-0AA0	3VA5125-6EC31-0AA0
30	3VA5130-4EC31-0AA0	3VA5130-5EC31-0AA0	3VA5130-6EC31-0AA0
35	3VA5135-4EC31-0AA0	3VA5135-5EC31-0AA0	3VA5135-6EC31-0AA0
40	3VA5140-4EC31-0AA0	3VA5140-5EC31-0AA0	3VA5140-6EC31-0AA0
45	3VA5145-4EC31-0AA0	3VA5145-5EC31-0AA0	3VA5145-6EC31-0AA0
50	3VA5150-4EC31-0AA0	3VA5150-5EC31-0AA0	3VA5150-6EC31-0AA0
60	3VA5160-4EC31-0AA0	3VA5160-5EC31-0AA0	3VA5160-6EC31-0AA0
70	3VA5170-4EC31-0AA0	3VA5170-5EC31-0AA0	3VA5170-6EC31-0AA0
80	3VA5180-4EC31-0AA0	3VA5180-5EC31-0AA0	3VA5180-6EC31-0AA0
90	3VA5190-4EC31-0AA0	3VA5190-5EC31-0AA0	3VA5190-6EC31-0AA0
100	3VA5110-4EC31-0AA0	3VA5110-5EC31-0AA0	3VA5110-6EC31-0AA0
110	3VA5111-4EC31-0AA0	3VA5111-5EC31-0AA0	3VA5111-6EC31-0AA0
125	3VA5112-4EC31-0AA0	3VA5112-5EC31-0AA0	3VA5112-6EC31-0AA0

TM240 ATAM			
15	3VA5195-4EF31-0AA0	3VA5195-5EF31-0AA0	3VA5195-6EF31-0AA0
20	3VA5120-4EF31-0AA0	3VA5120-5EF31-0AA0	3VA5120-6EF31-0AA0
30	3VA5130-4EF31-0AA0	3VA5130-5EF31-0AA0	3VA5130-6EF31-0AA0
40	3VA5140-4EF31-0AA0	3VA5140-5EF31-0AA0	3VA5140-6EF31-0AA0
50	3VA5150-4EF31-0AA0	3VA5150-5EF31-0AA0	3VA5150-6EF31-0AA0
60	3VA5160-4EF31-0AA0	3VA5160-5EF31-0AA0	3VA5160-6EF31-0AA0
70	3VA5170-4EF31-0AA0	3VA5170-5EF31-0AA0	3VA5170-6EF31-0AA0
80	3VA5180-4EF31-0AA0	3VA5180-5EF31-0AA0	3VA5180-6EF31-0AA0
100	3VA5110-4EF31-0AA0	3VA5110-5EF31-0AA0	3VA5110-6EF31-0AA0

Dimensions

Breaker	Poles	W in. (mm)	H in. (mm)	D in. (mm)	lbs.	kg
3VA51	1	1 (25.4)	5.5 (140)	3 (76.5)	0.84	0.38
3VA51	2	2 (50.8)	5.5 (140)	3 (76.5)	1.37	0.62
3VA51	3	3 (76.2)	5.5 (140)	3 (76.5)	1.73	0.78
3VA51	4	4 (101.6)	5.5 (140)	3 (76.5)	2.09	0.95

Shipping Weight



3VA51 125A 3-Pole

Ordering Information

The catalog numbers listed here are for complete, non-interchangeable trip circuit breakers without lugs.

Order required lugs or connection technology separately for field installation.

All 3VA51 thermal-magnetic trip circuit breakers are CSA approved and UL listed for reverse feed applications.

For NAVAL-rated thermal-magnetic trip circuit breakers, change the 13th digit of the catalog number to the number "1". (For example, a 18kA @600/347VAC, 40A, 3-pole, NAVAL rated 3VA51 would be catalogue number 3VA5140-5ED31-1AA0)

Ⓞ Available with NAVAL/50C ratings.

Molded Case Circuit Breakers

3VA51 125A Thermal-magnetic Trip Circuit Breakers

Selection

3VA51 125A Frame, 4-Pole Thermal-Magnetic Trip Unit

Cont. Ampere Rating	S-Interrupting Class (SEAS)	M-Interrupting Class (MEAS)	H-Interrupting Class (HEAS)
	Catalog Number	Catalog Number	Catalog Number
TM210 FTFM Unprotected Neutral			
15	3VA5195-4ED41-0AA0	3VA5195-5ED41-0AA0	3VA5195-6ED41-0AA0
20	3VA5120-4ED41-0AA0	3VA5120-5ED41-0AA0	3VA5120-6ED41-0AA0
25	3VA5125-4ED41-0AA0	3VA5125-5ED41-0AA0	3VA5125-6ED41-0AA0
30	3VA5130-4ED41-0AA0	3VA5130-5ED41-0AA0	3VA5130-6ED41-0AA0
35	3VA5135-4ED41-0AA0	3VA5135-5ED41-0AA0	3VA5135-6ED41-0AA0
40	3VA5140-4ED41-0AA0	3VA5140-5ED41-0AA0	3VA5140-6ED41-0AA0
45	3VA5145-4ED41-0AA0	3VA5145-5ED41-0AA0	3VA5145-6ED41-0AA0
50	3VA5150-4ED41-0AA0	3VA5150-5ED41-0AA0	3VA5150-6ED41-0AA0
60	3VA5160-4ED41-0AA0	3VA5160-5ED41-0AA0	3VA5160-6ED41-0AA0
70	3VA5170-4ED41-0AA0	3VA5170-5ED41-0AA0	3VA5170-6ED41-0AA0
80	3VA5180-4ED41-0AA0	3VA5180-5ED41-0AA0	3VA5180-6ED41-0AA0
90	3VA5190-4ED41-0AA0	3VA5190-5ED41-0AA0	3VA5190-6ED41-0AA0
100	3VA5110-4ED41-0AA0	3VA5110-5ED41-0AA0	3VA5110-6ED41-0AA0
110	3VA5111-4ED41-0AA0	3VA5111-5ED41-0AA0	3VA5111-6ED41-0AA0
125	3VA5112-4ED41-0AA0	3VA5112-5ED41-0AA0	3VA5112-6ED41-0AA0
TM210 FTFM 100% Neutral			
90	3VA5190-4GD41-0AA0	3VA5190-5GD41-0AA0	3VA5190-6GD41-0AA0
100	3VA5110-4GD41-0AA0	3VA5110-5GD41-0AA0	3VA5110-6GD41-0AA0
110	3VA5111-4GD41-0AA0	3VA5111-5GD41-0AA0	3VA5111-6GD41-0AA0
125	3VA5112-4GD41-0AA0	3VA5112-5GD41-0AA0	3VA5112-6GD41-0AA0
TM230 FTAM Unprotected Neutral			
15	3VA5195-4EC41-0AA0	3VA5195-5EC41-0AA0	3VA5195-6EC41-0AA0
20	3VA5120-4EC41-0AA0	3VA5120-5EC41-0AA0	3VA5120-6EC41-0AA0
25	3VA5125-4EC41-0AA0	3VA5125-5EC41-0AA0	3VA5125-6EC41-0AA0
30	3VA5130-4EC41-0AA0	3VA5130-5EC41-0AA0	3VA5130-6EC41-0AA0
35	3VA5135-4EC41-0AA0	3VA5135-5EC41-0AA0	3VA5135-6EC41-0AA0
40	3VA5140-4EC41-0AA0	3VA5140-5EC41-0AA0	3VA5140-6EC41-0AA0
45	3VA5145-4EC41-0AA0	3VA5145-5EC41-0AA0	3VA5145-6EC41-0AA0
50	3VA5150-4EC41-0AA0	3VA5150-5EC41-0AA0	3VA5150-6EC41-0AA0
60	3VA5160-4EC41-0AA0	3VA5160-5EC41-0AA0	3VA5160-6EC41-0AA0
70	3VA5170-4EC41-0AA0	3VA5170-5EC41-0AA0	3VA5170-6EC41-0AA0
80	3VA5180-4EC41-0AA0	3VA5180-5EC41-0AA0	3VA5180-6EC41-0AA0
90	3VA5190-4EC41-0AA0	3VA5190-5EC41-0AA0	3VA5190-6EC41-0AA0
100	3VA5110-4EC41-0AA0	3VA5110-5EC41-0AA0	3VA5110-6EC41-0AA0
110	3VA5111-4EC41-0AA0	3VA5111-5EC41-0AA0	3VA5111-6EC41-0AA0
125	3VA5112-4EC41-0AA0	3VA5112-5EC41-0AA0	3VA5112-6EC41-0AA0
TM230 FTFM 100% Neutral			
90	3VA5190-4GC41-0AA0	3VA5190-5GC41-0AA0	3VA5190-6GC41-0AA0
100	3VA5110-4GC41-0AA0	3VA5110-5GC41-0AA0	3VA5110-6GC41-0AA0
110	3VA5111-4GC41-0AA0	3VA5111-5GC41-0AA0	3VA5111-6GC41-0AA0
125	3VA5112-4GC41-0AA0	3VA5112-5GC41-0AA0	3VA5112-6GC41-0AA0
TM240 ATAM Unprotected Neutral			
15	3VA5195-4EF41-0AA0	3VA5195-5EF41-0AA0	3VA5195-6EF41-0AA0
20	3VA5120-4EF41-0AA0	3VA5120-5EF41-0AA0	3VA5120-6EF41-0AA0
30	3VA5130-4EF41-0AA0	3VA5130-5EF41-0AA0	3VA5130-6EF41-0AA0
40	3VA5140-4EF41-0AA0	3VA5140-5EF41-0AA0	3VA5140-6EF41-0AA0
50	3VA5150-4EF41-0AA0	3VA5150-5EF41-0AA0	3VA5150-6EF41-0AA0
60	3VA5160-4EF41-0AA0	3VA5160-5EF41-0AA0	3VA5160-6EF41-0AA0
70	3VA5170-4EF41-0AA0	3VA5170-5EF41-0AA0	3VA5170-6EF41-0AA0
80	3VA5180-4EF41-0AA0	3VA5180-5EF41-0AA0	3VA5180-6EF41-0AA0
100	3VA5110-4EF41-0AA0	3VA5110-5EF41-0AA0	3VA5110-6EF41-0AA0
TM240 ATAM 100% Neutral			
100	3VA5110-4GF41-0AA0	3VA5110-5GF41-0AA0	3VA5110-6GF41-0AA0



3VA51 125A 4-Pole

Ordering Information

The catalog numbers listed here are for complete, non-interchangeable trip circuit breakers without lugs.

Order required lugs or connection technology separately for field installation.

All 3VA51 thermal-magnetic trip circuit breakers are CSA approved and UL listed for reverse feed applications.

For NAVAL-rated thermal-magnetic trip circuit breakers, change the 13th digit of the catalog number to the number "1". (For example, a 18kA @600/347VAC, 40A, 3-pole, NAVAL rated 3VA51 would be catalogue number 3VA5140-5ED31-1AA0)

Molded Case Circuit Breakers

3VA51 125A Thermal-magnetic Trip Circuit Breakers

Technical information

Interrupting Ratings for 3VA51

Interrupting Class	Breaker Type	RMS Symmetrical Amperes (kA)											
		Volts AC (50/60 Hz)							Volts DC				
		120	240	277	347	480Y/277V	480	600Y/347V	125	250	500 ^①	600 ^①	
S	SEAS	1	65		25	14				14			
		2, 3, 4		65				25	25	14	14	50	50
M	MEAS	1	85		35	18				25			
		2, 3, 4		85				35	35	18	25	85	85
H	HEAS	1	150		50	18				30			
		2, 3, 4		150				65	65	25	30	100	100

① Applies to 3VA51 3-Pole

Trip Settings for 3VA51

TM210 - FTFM		
I _n (A)	I _n (A)	I _n (A)
15	15	300
20	20	300
25	25	300
30	30	300
35	35	350
40	40	400
45	45	450
50	50	500
60	60	600
70	70	700
80	80	800
90	90	900
100	100	1000
110	110	1100
125	125	1250

TM230 - FTAM								
I _n (A)	I _n (A)	I _n (A)						
15	15	150	180	210	240	270	300	300
20	20	150	180	210	240	270	300	300
25	25	150	180	210	240	270	300	300
30	30	150	180	210	240	270	300	300
35	35	175	210	245	280	315	350	350
40	40	200	240	280	320	360	400	400
45	45	225	270	315	360	405	450	450
50	50	250	300	350	400	450	500	500
60	60	300	360	420	480	540	600	600
70	70	350	420	490	560	630	700	700
80	80	400	480	560	640	720	800	800
90	90	450	540	630	720	810	900	900
100	100	500	600	700	800	900	1000	1000
110	110	550	660	770	880	990	1100	1100
125	125	625	750	875	1000	1125	1250	1250

TM240 - ATAM								
I _n (A)	I _n (A)	I _n (A)						
15	12	150	180	210	240	270	300	300
20	16	150	180	210	240	270	300	300
30	24	150	180	210	240	270	300	300
40	32	200	240	280	320	360	400	400
50	40	250	300	350	400	450	500	500
60	48	300	360	420	480	540	600	600
70	56	350	420	490	560	630	700	700
80	64	400	480	560	640	720	800	800
100	80	500	600	700	800	900	1000	1000

Connectors for 75C Wire for 3VA51

Type	Min. cable size	Max. cable size	Catalog No. (kit of 3 lugs)	Catalog No. (kit of 4 lugs)
Steel wrap around (Cu cable only), 1 cable lugs	AWG 14	3/0	3VA9133-0JA11	3VA9134-0JA11
Aluminum body lug small (Cu/Al cable), 1 cable lug	AWG 14	AWG 10	3VA9133-0JB10	3VA9134-0JB10
Aluminum body lug (Cu/Al cable), 1 cable lugs	AWG 14	3/0	3VA9133-0JB11	3VA9134-0JB11
Aluminum body lug small with control wire tap (Cu/Al cable), 1 cable lug	AWG 14	AWG 10	3VA9133-0JG10	3VA9134-0JG10
Aluminum body lug with control wire tap (Cu/Al cable), 1 cable lugs	AWG 14	3/0	3VA9133-0JG11	3VA9134-0JG11
Aluminum body lug large (Cu/Al cable), 1 cable lugs with 1 extended terminal cover	AWG 4	300 kcmil	3VA9133-0JJ12	
Aluminum body lug large with control wire tap (Cu/Al cable), 1 cable lug and 1 extended terminal cover	AWG 4	300 kcmil	3VA9133-0JC12	
Distribution lug, 6 cables (Cu/Al cable), 1 cable lugs with 1 extended terminal cover	AWG 14	AWG 2	3VA9133-0JF60	3VA9134-0JF60
Copper body lug small (Cu cable only), 1 cable lugs	AWG 14	AWG 10	3VA9133-0JD10	3VA9134-0JD10
Copper body lug (Cu cable only), 1 cable lugs	AWG 14	2/0	3VA9133-0JD11	3VA9134-0JD11
Copper body lug small with control wire tap (Cu cable only), 1 cable lugs	AWG 14	AWG 10	3VA9133-0JK10	3VA9134-0JK10
Copper body lug with control wire tap (Cu cable only), 1 cable lugs	AWG 14	2/0	3VA9133-0JK11	3VA9134-0JK11

Internal accessories configuration	3VA4/3VA5 125 A 1 in 2-pole /2-pole				3VA5 125 A 3 & 4-pole						
	Slot No.:	23	22	21	125 A	23	22	21	11	12	13
Auxiliary switch	Type										
Auxiliary switch	AUX_HQ	x	x	x		x	x	x		x	x
	AUX_HQ_el	x	x	x		x	x	x		x	x
	AUX_HP			x							x
Leading changeover switch	LCS_HQ										
	LCS_HQ_el										
	LCS_HP										x
Auxiliary switch	Type										
Trip alarm switch	TAS_HQ	x	x			x	x			x	x
	TAS_HQ_el	x	x			x	x			x	x
	TAS_HP			x							x
Short circuit alarm switch	SAS_HQ										
	SAS_HQ_el										
Auxiliary switch	Type										
Shunt trip flexible	STF	x				x					
Shunt trip left	STL	x				x					
	STL_el										
Residual current release	RCR										
Undervoltage release	UVR	x				x					
Universal release	UVI	x				x					
Other											
Cylinder lock (type Ronis)											x

Molded Case Circuit Breakers

3VA61 150A Electronic Trip Circuit Breakers

Selection



3VA61 150A 3-Pole

Ordering Information

The catalog numbers listed below are for complete, non-interchangeable trip circuit breakers without lugs.

Order required lugs or connection technology separately for field installation.

All 3VA61 electronic trip circuit breakers are CSA approved and UL listed for reverse feed applications.

All 3VA61 electronic trip circuit breakers are available with 100% ratings.

For 100% rated electronic trip circuit breakers, change the 13th digit of the catalog number to the number "2". (For example, a 18kA @600VAC, 40A, 3-pole, 100% rated 3VA61 would be catalog number 3VA6140-5HL31-2AA0)

Requires the use of copper lugs — see lug table below.

All 3VA6 circuit breakers are certified to CSA C22.2 No. 5, and UL 489 Supplement SB, are marked "Naval", and are suitable for use at 50C.

3VA61 150A Frame 3-Pole Electronic Trip Unit

Continuous Ampere	M-Interrupting Class (MDAE) Catalog Number	H-Interrupting Class (HDAE) Catalog Number	C-Interrupting Class (CDAE) Catalog Number	L-Interrupting Class (LDAE) Catalog Number	E-Interrupting Class (EAE) Catalog Number
ETU320 LI with dials					
40	3VA6140-5HL31-0AA0	3VA6140-6HL31-0AA0	3VA6140-7HL31-0AA0	3VA6140-8HL31-0AA0	3VA6160-0HL31-0AA0 ^①
100	3VA6110-5HL31-0AA0	3VA6110-6HL31-0AA0	3VA6110-7HL31-0AA0	3VA6110-8HL31-0AA0	3VA6110-0HL31-0AA0
150	3VA6115-5HL31-0AA0	3VA6115-6HL31-0AA0	3VA6115-7HL31-0AA0	3VA6115-8HL31-0AA0	3VA6115-0HL31-0AA0
ETU330 LIG with dials					
40	3VA6140-5HM31-0AA0	3VA6140-6HM31-0AA0	3VA6140-7HM31-0AA0	3VA6140-8HM31-0AA0	3VA6160-0HM31-0AA0 ^①
100	3VA6110-5HM31-0AA0	3VA6110-6HM31-0AA0	3VA6110-7HM31-0AA0	3VA6110-8HM31-0AA0	3VA6110-0HM31-0AA0
150	3VA6115-5HM31-0AA0	3VA6115-6HM31-0AA0	3VA6115-7HM31-0AA0	3VA6115-8HM31-0AA0	3VA6115-0HM31-0AA0
ETU350 LSI with dials					
40	3VA6140-5HN31-0AA0	3VA6140-6HN31-0AA0	3VA6140-7HN31-0AA0	3VA6140-8HN31-0AA0	3VA6160-0HN31-0AA0 ^①
100	3VA6110-5HN31-0AA0	3VA6110-6HN31-0AA0	3VA6110-7HN31-0AA0	3VA6110-8HN31-0AA0	3VA6110-0HN31-0AA0
150	3VA6115-5HN31-0AA0	3VA6115-6HN31-0AA0	3VA6115-7HN31-0AA0	3VA6115-8HN31-0AA0	3VA6115-0HN31-0AA0
ETU550 LSI with LCD					
40	3VA6140-5JP31-0AA0	3VA6140-6JP31-0AA0	3VA6140-7JP31-0AA0	3VA6140-8JP31-0AA0	—
100	3VA6110-5JP31-0AA0	3VA6110-6JP31-0AA0	3VA6110-7JP31-0AA0	3VA6110-8JP31-0AA0	—
150	3VA6115-5JP31-0AA0	3VA6115-6JP31-0AA0	3VA6115-7JP31-0AA0	3VA6115-8JP31-0AA0	—
ETU556 LSI(G Alarm) with LCD					
40	3VA6140-5JT31-0AA0	3VA6140-6JT31-0AA0	3VA6140-7JT31-0AA0	3VA6140-8JT31-0AA0	—
100	3VA6110-5JT31-0AA0	3VA6110-6JT31-0AA0	3VA6110-7JT31-0AA0	3VA6110-8JT31-0AA0	—
150	3VA6115-5JT31-0AA0	3VA6115-6JT31-0AA0	3VA6115-7JT31-0AA0	3VA6115-8JT31-0AA0	—
ETU560 LSI(G Alarm) with LCD					
40	3VA6140-5JQ31-0AA0	3VA6140-6JQ31-0AA0	3VA6140-7JQ31-0AA0	3VA6140-8JQ31-0AA0	—
100	3VA6110-5JQ31-0AA0	3VA6110-6JQ31-0AA0	3VA6110-7JQ31-0AA0	3VA6110-8JQ31-0AA0	—
150	3VA6115-5JQ31-0AA0	3VA6115-6JQ31-0AA0	3VA6115-7JQ31-0AA0	3VA6115-8JQ31-0AA0	—
ETU820 LI LCD with Metering					
40	3VA6140-5KL31-0AA0	3VA6140-6KL31-0AA0	3VA6140-7KL31-0AA0	3VA6140-8KL31-0AA0	—
100	3VA6110-5KL31-0AA0	3VA6110-6KL31-0AA0	3VA6110-7KL31-0AA0	3VA6110-8KL31-0AA0	—
150	3VA6115-5KL31-0AA0	3VA6115-6KL31-0AA0	3VA6115-7KL31-0AA0	3VA6115-8KL31-0AA0	—
ETU830 LIG with LCD and Metering					
40	3VA6140-5KM31-0AA0	3VA6140-6KM31-0AA0	3VA6140-7KM31-0AA0	3VA6140-8KM31-0AA0	—
100	3VA6110-5KM31-0AA0	3VA6110-6KM31-0AA0	3VA6110-7KM31-0AA0	3VA6110-8KM31-0AA0	—
150	3VA6115-5KM31-0AA0	3VA6115-6KM31-0AA0	3VA6115-7KM31-0AA0	3VA6115-8KM31-0AA0	—
ETU850 LSI with LCD and Metering					
40	3VA6140-5KP31-0AA0	3VA6140-6KP31-0AA0	3VA6140-7KP31-0AA0	3VA6140-8KP31-0AA0	—
100	3VA6110-5KP31-0AA0	3VA6110-6KP31-0AA0	3VA6110-7KP31-0AA0	3VA6110-8KP31-0AA0	—
150	3VA6115-5KP31-0AA0	3VA6115-6KP31-0AA0	3VA6115-7KP31-0AA0	3VA6115-8KP31-0AA0	—
ETU856 LSI(G Alarm) with LCD and Metering					
40	3VA6140-5KT31-0AA0	3VA6140-6KT31-0AA0	3VA6140-7KT31-0AA0	3VA6140-8KT31-0AA0	3VA6160-0KT31-0AA0 ^①
100	3VA6110-5KT31-0AA0	3VA6110-6KT31-0AA0	3VA6110-7KT31-0AA0	3VA6110-8KT31-0AA0	3VA6110-0KT31-0AA0
150	3VA6115-5KT31-0AA0	3VA6115-6KT31-0AA0	3VA6115-7KT31-0AA0	3VA6115-8KT31-0AA0	3VA6115-0KT31-0AA0
ETU860 LSI(G Alarm) with LCD and Metering					
40	3VA6140-5KQ31-0AA0	3VA6140-6KQ31-0AA0	3VA6140-7KQ31-0AA0	3VA6140-8KQ31-0AA0	3VA6160-0KQ31-0AA0 ^①
100	3VA6110-5KQ31-0AA0	3VA6110-6KQ31-0AA0	3VA6110-7KQ31-0AA0	3VA6110-8KQ31-0AA0	3VA6110-0KQ31-0AA0
150	3VA6115-5KQ31-0AA0	3VA6115-6KQ31-0AA0	3VA6115-7KQ31-0AA0	3VA6115-8KQ31-0AA0	3VA6115-0KQ31-0AA0

^① The lowest amperage trip unit available for the EDAE class breakers is 60 amps.

Molded Case Circuit Breakers

3VA61 150A Electronic Trip Circuit Breakers

Selection



3VA61 150A 4-Pole

Ordering Information

The catalog numbers listed below are for complete, non-interchangeable trip circuit breakers without lugs.

Order required lugs or connection technology separately for field installation.

All 3VA61 electronic trip circuit breakers are CSA approved and UL listed for reverse feed applications.

All 3VA61 electronic trip circuit breakers are available with 100% ratings.

For 100% rated electronic trip circuit breakers, change the 13th digit of the catalog number to the number "2". (For example, a 18kA @600VAC, 40A, 3-pole, 100% rated 3VA61 would be catalog number 3VA6140-5HL31-2AA0) Requires the use of copper lugs — see lug table below.

All 3VA6 circuit breakers are certified to CSA C22.2 No 5, and UL 489 listed Supplement SB, are marked "Naval", and are suitable for use at 50C.

3VA61 150A Frame 4-Pole Electronic Trip Unit

Continuous Ampere	M-Interrupting Class (MDAE) Catalog Number	H-Interrupting Class (HDAE) Catalog Number	C-Interrupting Class (CDAE) Catalog Number	L-Interrupting Class (LDAE) Catalog Number	E-Interrupting Class (EAE) Catalog Number
ETU320 LI with dials					
40	3VA6140-5HL41-0AA0	3VA6140-6HL41-0AA0	3VA6140-7HL41-0AA0	3VA6140-8HL41-0AA0	3VA6160-0HL41-0AA0 ^①
100	3VA6110-5HL41-0AA0	3VA6110-6HL41-0AA0	3VA6110-7HL41-0AA0	3VA6110-8HL41-0AA0	3VA6110-0HL41-0AA0
150	3VA6115-5HL41-0AA0	3VA6115-6HL41-0AA0	3VA6115-7HL41-0AA0	3VA6115-8HL41-0AA0	3VA6115-0HL41-0AA0
ETU330 LIG with dials					
40	3VA6140-5HM41-0AA0	3VA6140-6HM41-0AA0	3VA6140-7HM41-0AA0	3VA6140-8HM41-0AA0	3VA6160-0HM41-0AA0 ^①
100	3VA6110-5HM41-0AA0	3VA6110-6HM41-0AA0	3VA6110-7HM41-0AA0	3VA6110-8HM41-0AA0	3VA6110-0HM41-0AA0
150	3VA6115-5HM41-0AA0	3VA6115-6HM41-0AA0	3VA6115-7HM41-0AA0	3VA6115-8HM41-0AA0	3VA6115-0HM41-0AA0
ETU350 LSI with dials					
40	3VA6140-5HN41-0AA0	3VA6140-6HN41-0AA0	3VA6140-7HN41-0AA0	3VA6140-8HN41-0AA0	3VA6160-0HN41-0AA0 ^①
100	3VA6110-5HN41-0AA0	3VA6110-6HN41-0AA0	3VA6110-7HN41-0AA0	3VA6110-8HN41-0AA0	3VA6110-0HN41-0AA0
150	3VA6115-5HN41-0AA0	3VA6115-6HN41-0AA0	3VA6115-7HN41-0AA0	3VA6115-8HN41-0AA0	3VA6115-0HN41-0AA0
ETU550 LSI with LCD					
40	3VA6140-5JP41-0AA0	3VA6140-6JP41-0AA0	3VA6140-7JP41-0AA0	3VA6140-8JP41-0AA0	—
100	3VA6110-5JP41-0AA0	3VA6110-6JP41-0AA0	3VA6110-7JP41-0AA0	3VA6110-8JP41-0AA0	—
150	3VA6115-5JP41-0AA0	3VA6115-6JP41-0AA0	3VA6115-7JP41-0AA0	3VA6115-8JP41-0AA0	—
ETU556 LSI(G Alarm) with LCD					
40	3VA6140-5JT41-0AA0	3VA6140-6JT41-0AA0	3VA6140-7JT41-0AA0	3VA6140-8JT41-0AA0	—
100	3VA6110-5JT41-0AA0	3VA6110-6JT41-0AA0	3VA6110-7JT41-0AA0	3VA6110-8JT41-0AA0	—
150	3VA6115-5JT41-0AA0	3VA6115-6JT41-0AA0	3VA6115-7JT41-0AA0	3VA6115-8JT41-0AA0	—
ETU560 LSI(G) with LCD					
40	3VA6140-5JQ41-0AA0	3VA6140-6JQ41-0AA0	3VA6140-7JQ41-0AA0	3VA6140-8JQ41-0AA0	—
100	3VA6110-5JQ41-0AA0	3VA6110-6JQ41-0AA0	3VA6110-7JQ41-0AA0	3VA6110-8JQ41-0AA0	—
150	3VA6115-5JQ41-0AA0	3VA6115-6JQ41-0AA0	3VA6115-7JQ41-0AA0	3VA6115-8JQ41-0AA0	—
ETU820 LI LCD with Metering					
40	3VA6140-5KL41-0AA0	3VA6140-6KL41-0AA0	3VA6140-7KL41-0AA0	3VA6140-8KL41-0AA0	—
100	3VA6110-5KL41-0AA0	3VA6110-6KL41-0AA0	3VA6110-7KL41-0AA0	3VA6110-8KL41-0AA0	—
150	3VA6115-5KL41-0AA0	3VA6115-6KL41-0AA0	3VA6115-7KL41-0AA0	3VA6115-8KL41-0AA0	—
ETU830 LIG with LCD and Metering					
40	3VA6140-5KM41-0AA0	3VA6140-6KM41-0AA0	3VA6140-7KM41-0AA0	3VA6140-8KM41-0AA0	—
100	3VA6110-5KM41-0AA0	3VA6110-6KM41-0AA0	3VA6110-7KM41-0AA0	3VA6110-8KM41-0AA0	—
150	3VA6115-5KM41-0AA0	3VA6115-6KM41-0AA0	3VA6115-7KM41-0AA0	3VA6115-8KM41-0AA0	—
ETU850 LSI with LCD and Metering					
40	3VA6140-5KP41-0AA0	3VA6140-6KP41-0AA0	3VA6140-7KP41-0AA0	3VA6140-8KP41-0AA0	—
100	3VA6110-5KP41-0AA0	3VA6110-6KP41-0AA0	3VA6110-7KP41-0AA0	3VA6110-8KP41-0AA0	—
150	3VA6115-5KP41-0AA0	3VA6115-6KP41-0AA0	3VA6115-7KP41-0AA0	3VA6115-8KP41-0AA0	—
ETU856 LSI(G Alarm) with LCD and Metering					
40	3VA6140-5KT41-0AA0	3VA6140-6KT41-0AA0	3VA6140-7KT41-0AA0	3VA6140-8KT41-0AA0	3VA6160-0KT41-0AA0 ^①
100	3VA6110-5KT41-0AA0	3VA6110-6KT41-0AA0	3VA6110-7KT41-0AA0	3VA6110-8KT41-0AA0	3VA6110-0KT41-0AA0
150	3VA6115-5KT41-0AA0	3VA6115-6KT41-0AA0	3VA6115-7KT41-0AA0	3VA6115-8KT41-0AA0	3VA6115-0KT41-0AA0
ETU860 LSI(G) with LCD and Metering					
40	3VA6140-5KQ41-0AA0	3VA6140-6KQ41-0AA0	3VA6140-7KQ41-0AA0	3VA6140-8KQ41-0AA0	3VA6160-0KQ41-0AA0 ^①
100	3VA6110-5KQ41-0AA0	3VA6110-6KQ41-0AA0	3VA6110-7KQ41-0AA0	3VA6110-8KQ41-0AA0	3VA6110-0KQ41-0AA0
150	3VA6115-5KQ41-0AA0	3VA6115-6KQ41-0AA0	3VA6115-7KQ41-0AA0	3VA6115-8KQ41-0AA0	3VA6115-0KQ41-0AA0

① The lowest amperage trip unit available for the EDAE class breakers is 60 amps.

Molded Case Circuit Breakers

3VA61 150A Electronic Trip Circuit Breakers

Technical information

Connectors for 75C wire for 3VA61

Type	Minimum cable size	Maximum cable size	Part Number (kit of 3 lugs)	Part Number (kit of 4 lugs)
Steel Wrap around (Cu cable only) single cable lugs	AWG 10	3/0	3VA9143-0JA12	3VA9144-0JA12
	AWG 4	350 kcmil	3VA9243-0JA12	3VA9244-0JA12
Aluminum Body Lug (Cu/Al cable) single cable lugs	AWG 14	1/0	3VA9143-0JB11	3VA9144-0JB11
	AWG 6	350 kcmil	3VA9243-0JB12	3VA9244-0JB12
Aluminum body lug with control wire tap (Cu/Al cable) single cable lugs	AWG 14	1/0	3VA9143-0JG11	3VA9144-0JG11
	AWG 6	350 kcmil	3VA9243-0JG12	3VA9244-0JG12
Aluminum body lug large (Cu/Al cable) single cable lugs and 1 ext'd terminal cover	AWG 2	350 kcmil	3VA9243-0JJ13	3VA9244-0JJ13
Aluminum body lug large with control wire tap (Cu/Al cable) single cable lugs and 1 extended terminal cover	AWG 2	350 kcmil	3VA9243-0JC13	3VA9244-0JC13
Aluminum body lug, 2 cables (Cu/Al cable) with 1 extended terminal cover	AWG 4	300 kcmil	3VA9243-0JJ22	3VA9244-0JJ22
Aluminum body lug, 2 cables (Cu/Al cable) with control wire tap and 1 extended terminal cover	AWG 4	300 kcmil	3VA9243-0JC22	3VA9244-0JC22
Distribution lug, 6 Cables (Cu/Al cable) with 1 extended terminal cover	AWG 14	AWG 2	3VA9243-0JF60	3VA9244-0JF60
Copper body lug (Cu cable only) single cable lugs kit of 3 single lugs (meets requirements for 100% rated breakers)	AWG 14	1/0	3VA9143-0JD11	3VA9144-0JD11
	AWG 6	350 kcmil	3VA9243-0JD12	3VA9244-0JD12
Copper body lug (Cu cable only) with control wire tap single cable lugs	AWG 14	1/0	3VA9143-0JK11	3VA9144-0JK11
	AWG 6	350 kcmil	3VA9243-0JK12	3VA9244-0JK12

Interrupting Ratings for 3VA61

Interrupting Class	Breaker Type	RMS Symmetrical Amperes (kA)			
		Volts AC (50/60 Hz)			
		240	480Y/277V	480	600
M	MDAE	100	35	35	18
H	HDAE	100	65	65	22
C	CDAE	200	100	100	35
L	LDAE	200	150	150	50
E	EDAE	—	200	200	100

Dimensions

Breaker	Poles	W in. (mm)	H in. (mm)	D in. (mm)	lbs.	kg
3VA61	3	4.1 (105)	7.8 (198)	3.4 (86)	5.5	2.5
3VA61	4	5.5 (140)	7.8 (198)	3.4 (86)	7.1	3.2

Shipping Weight

Molded Case Circuit Breakers

3VA61 150A Electronic Trip Circuit Breakers

Technical information

Trip Settings for 3VA61

ETU320-LI, ETU330-LIG, ETU350-LSI

Continuous Amperage	LI, LIG, LSI			LSI		LIG	LI, LIG, LSI 4P only
I_n (Amp)	I_n (Amp) (L)	t_{sd} (sec) (L)	I_n (Amp) (I)Ⓣ	$I_{sd} = xI_r$ (Amp) (S)	t_{sd} (sec) (S)	I_n (Amp) (G)	$I_n = xI_n$ (Amp)
40	15 - 40	0.5 - 17	60-480	1.5 - 10	0.08 - 0.4	15 - 40	1 / OFF
100	40 - 100	0.5 - 17	150-1200	1.5 - 10		20 - 100	0.5 - 1 / OFF
150	60 - 150	0.5 - 17	225-1500	1.5 - 10		30 - 150	0.5 - 1 / OFF

Ⓣ I_n for ETU350 is fixed at 12X I_n

ETU550-LSI, ETU556 LSI(A), ETU560-LSIG, ETU820-LI, ETU830-LIG, ETU850-LSI, ETU856 LSI(A), ETU860-LSIG

Continuous Amperage	LI, LIG, LSI, LSIG, LSI(G)			LSI, LSIG, LSI(G)		LIG, LSIG, LSI(G)		LSI 3P with External CT	LI, LIG, LSI, LSIG, LSI(G) 4P only
I_n (Amp)	I_n (Amp) (L)	t_{sd} (sec) (L)	I_n (Amp) (I)	I_{sd} (Amp) (S)	t_{sd} (sec) (S)	I_n (Amp) (G)	t_n (G)	$I_n = xI_n$ (Amp)	I_n (Amp)
40	15 - 40	0.5 - 25	60-480	24 - 400	0.05 - 0.5	15 - 40	0.05 - 0.8	15 - 64 / OFF	15 - 64 / OFF
100	40 - 100	0.5 - 25	150-1200	60 - 1000		20 - 100		20 - 160 / OFF	20 - 150 / OFF
150	60 - 150	0.5 - 20	225-1500	90 - 1500		30 - 150		30 - 240 / OFF	30 - 150 / OFF

For specific trip settings refer to the Electronic Trip Unit section of the 3VA Systems Manual, which can be found in the document download center at https://www.siemens.com/download?BTLV_50412.

Internal accessories Optional equipment	Slot No.:	3VA6 150/250 A 3-pole							3VA6 150/250 A 4-pole											
		24	23	24	21	250 A	11	12	13	14	24	23	22	21	250 A	11	12	13	14	
Auxiliary switch	Type																			
Auxiliary switch	AUX_HQ	x	x	x	x		x	x	x	x		x	x	x	x		x	x	x	x
	AUX_HQ_el	x	x	x	x		x	x	x	x		x	x	x	x		x	x	x	x
	AUX_HP	x		x			x		x			x		x			x		x	
Leading changeover switch	LCS_HQ						x									x				
	LCS_HQ_el						x									x				
	LCS_HP						x									x				
Auxiliary switch	Type																			
Trip alarm switch	TAS_HQ		x	x			x	x				x	x							
	TAS_HQ_el		x	x			x	x				x	x							
	TAS_HP		x				x					x								
Electrical alarm switch	EAS_HQ																		x	
	EAS_HQ_el																		x	
Auxiliary switch	Type																			
Shunt trip flexible	STF		x				x					x								
Shunt trip left	STL		x																	
Undervoltage release	UVR		x																	
Universal release	UVI		x																	
ETU/communication	Type																			
Communication module	COM060																		x	
Breaker data server																			x	
24 V module																			x	
Other																				
Cylinder lock (type Ronis)																			x	

See page 5-72 for internal accessory part numbers.

Molded Case Circuit Breakers

3VA52 250A Thermal-magnetic Trip Circuit Breakers

Selection

3VA52 250 A Frame, 2-(3)Pole Thermal-Magnetic Trip Unit

Cont. Ampere Rating	M-Interrupting Class (MFAS)	H-Interrupting Class (HFAS)	C-Interrupting Class (CFAS)
	Catalogue Number	Catalogue Number	Catalogue Number

TM210 FTFM

40	3VA5240-5ED61-0AA0	3VA5240-6ED61-0AA0	3VA5240-7ED61-0AA0
45	3VA5245-5ED61-0AA0	3VA5245-6ED61-0AA0	3VA5245-7ED61-0AA0
50	3VA5250-5ED61-0AA0	3VA5250-6ED61-0AA0	3VA5250-7ED61-0AA0
60	3VA5260-5ED61-0AA0	3VA5260-6ED61-0AA0	3VA5260-7ED61-0AA0
70	3VA5270-5ED61-0AA0	3VA5270-6ED61-0AA0	3VA5270-7ED61-0AA0
80	3VA5280-5ED61-0AA0	3VA5280-6ED61-0AA0	3VA5280-7ED61-0AA0
90	3VA5290-5ED61-0AA0	3VA5290-6ED61-0AA0	3VA5290-7ED61-0AA0
100	3VA5210-5ED61-0AA0	3VA5210-6ED61-0AA0	3VA5210-7ED61-0AA0
110	3VA5211-5ED61-0AA0	3VA5211-6ED61-0AA0	3VA5211-7ED61-0AA0
125	3VA5212-5ED61-0AA0	3VA5212-6ED61-0AA0	3VA5212-7ED61-0AA0
150	3VA5215-5ED61-0AA0	3VA5215-6ED61-0AA0	3VA5215-7ED61-0AA0
175	3VA5217-5ED61-0AA0	3VA5217-6ED61-0AA0	3VA5217-7ED61-0AA0
200	3VA5220-5ED61-0AA0	3VA5220-6ED61-0AA0	3VA5220-7ED61-0AA0
225	3VA5222-5ED61-0AA0	3VA5222-6ED61-0AA0	3VA5222-7ED61-0AA0
250	3VA5225-5ED61-0AA0	3VA5225-6ED61-0AA0	3VA5225-7ED61-0AA0

TM230 FTAM

70	3VA5270-5EC61-0AA0	3VA5270-6EC61-0AA0	3VA5270-7EC61-0AA0
80	3VA5280-5EC61-0AA0	3VA5280-6EC61-0AA0	3VA5280-7EC61-0AA0
90	3VA5290-5EC61-0AA0	3VA5290-6EC61-0AA0	3VA5290-7EC61-0AA0
100	3VA5210-5EC61-0AA0	3VA5210-6EC61-0AA0	3VA5210-7EC61-0AA0
110	3VA5211-5EC61-0AA0	3VA5211-6EC61-0AA0	3VA5211-7EC61-0AA0
125	3VA5212-5EC61-0AA0	3VA5212-6EC61-0AA0	3VA5212-7EC61-0AA0
150	3VA5215-5EC61-0AA0	3VA5215-6EC61-0AA0	3VA5215-7EC61-0AA0
175	3VA5217-5EC61-0AA0	3VA5217-6EC61-0AA0	3VA5217-7EC61-0AA0
200	3VA5220-5EC61-0AA0	3VA5220-6EC61-0AA0	3VA5220-7EC61-0AA0
225	3VA5222-5EC61-0AA0	3VA5222-6EC61-0AA0	3VA5222-7EC61-0AA0
250	3VA5225-5EC61-0AA0	3VA5225-6EC61-0AA0	3VA5225-7EC61-0AA0



3VA52 250A 3-Pole

Ordering Information

The catalog numbers listed here are for complete, non-interchangeable trip circuit breakers without lugs.

Order required lugs or connection technology separately for field installation.

All 3VA52 thermal-magnetic trip circuit breakers are CSA approved / UL listed for reverse feed applications.

For NAVAL rated thermal-magnetic trip circuit breakers, change the 13th digit of the catalog number to the number "1". (For example, a 18kA @600VAC, 150A, 3-pole, NAVAL rated 3VA52 would be catalog number 3VA5215-5ED31-1AA0)

Dimensions

Shipping Weight

Breaker	Poles	W in. (mm)	H in. (mm)	D in. (mm)	lbs.	kg
3VA52	2(3-) pole	4.1 (105)	7.3 (185)	3.3 (83)	4.1	1.9
3VA52	3-pole	4.1 (105)	7.3 (185)	3.3 (83)	4.5	2.1

Molded Case Circuit Breakers

3VA52 250A Thermal-magnetic Trip Circuit Breakers

Selection

3VA52 250 A Frame, 3-Pole Thermal-Magnetic Trip Unit

Cont. Ampere Rating	M-Interrupting Class (MFAS)	H-Interrupting Class (HFAS)	C-Interrupting Class (CFAS)
	Catalog Number	Catalog Number	Catalog Number

TM210 FTFM[Ⓞ]

40	3VA5240-5ED31-0AA0	3VA5240-6ED31-0AA0	3VA5240-7ED31-0AA0
45	3VA5245-5ED31-0AA0	3VA5245-6ED31-0AA0	3VA5245-7ED31-0AA0
50	3VA5250-5ED31-0AA0	3VA5250-6ED31-0AA0	3VA5250-7ED31-0AA0
60	3VA5260-5ED31-0AA0	3VA5260-6ED31-0AA0	3VA5260-7ED31-0AA0
70	3VA5270-5ED31-0AA0	3VA5270-6ED31-0AA0	3VA5270-7ED31-0AA0
80	3VA5280-5ED31-0AA0	3VA5280-6ED31-0AA0	3VA5280-7ED31-0AA0
90	3VA5290-5ED31-0AA0	3VA5290-6ED31-0AA0	3VA5290-7ED31-0AA0
100	3VA5210-5ED31-0AA0	3VA5210-6ED31-0AA0	3VA5210-7ED31-0AA0
110	3VA5211-5ED31-0AA0	3VA5211-6ED31-0AA0	3VA5211-7ED31-0AA0
125	3VA5212-5ED31-0AA0	3VA5212-6ED31-0AA0	3VA5212-7ED31-0AA0
150	3VA5215-5ED31-0AA0	3VA5215-6ED31-0AA0	3VA5215-7ED31-0AA0
175	3VA5217-5ED31-0AA0	3VA5217-6ED31-0AA0	3VA5217-7ED31-0AA0
200	3VA5220-5ED31-0AA0	3VA5220-6ED31-0AA0	3VA5220-7ED31-0AA0
225	3VA5222-5ED31-0AA0	3VA5222-6ED31-0AA0	3VA5222-7ED31-0AA0
250	3VA5225-5ED31-0AA0	3VA5225-6ED31-0AA0	3VA5225-7ED31-0AA0

TM230 FTAM[Ⓞ]

70	3VA5270-5EC31-0AA0	3VA5270-6EC31-0AA0	3VA5270-7EC31-0AA0
80	3VA5280-5EC31-0AA0	3VA5280-6EC31-0AA0	3VA5280-7EC31-0AA0
90	3VA5290-5EC31-0AA0	3VA5290-6EC31-0AA0	3VA5290-7EC31-0AA0
100	3VA5210-5EC31-0AA0	3VA5210-6EC31-0AA0	3VA5210-7EC31-0AA0
110	3VA5211-5EC31-0AA0	3VA5211-6EC31-0AA0	3VA5211-7EC31-0AA0
125	3VA5212-5EC31-0AA0	3VA5212-6EC31-0AA0	3VA5212-7EC31-0AA0
150	3VA5215-5EC31-0AA0	3VA5215-6EC31-0AA0	3VA5215-7EC31-0AA0
175	3VA5217-5EC31-0AA0	3VA5217-6EC31-0AA0	3VA5217-7EC31-0AA0
200	3VA5220-5EC31-0AA0	3VA5220-6EC31-0AA0	3VA5220-7EC31-0AA0
225	3VA5222-5EC31-0AA0	3VA5222-6EC31-0AA0	3VA5222-7EC31-0AA0
250	3VA5225-5EC31-0AA0	3VA5225-6EC31-0AA0	3VA5225-7EC31-0AA0

TM240 ATAM

70	3VA5270-5EF31-0AA0	3VA5270-6EF31-0AA0	3VA5270-7EF31-0AA0
80	3VA5280-5EF31-0AA0	3VA5280-6EF31-0AA0	3VA5280-7EF31-0AA0
100	3VA5210-5EF31-0AA0	3VA5210-6EF31-0AA0	3VA5210-7EF31-0AA0
125	3VA5212-5EF31-0AA0	3VA5212-6EF31-0AA0	3VA5212-7EF31-0AA0
150	3VA5215-5EF31-0AA0	3VA5215-6EF31-0AA0	3VA5215-7EF31-0AA0
175	3VA5217-5EF31-0AA0	3VA5217-6EF31-0AA0	3VA5217-7EF31-0AA0
200	3VA5220-5EF31-0AA0	3VA5220-6EF31-0AA0	3VA5220-7EF31-0AA0
250	3VA5225-5EF31-0AA0	3VA5225-6EF31-0AA0	3VA5225-7EF31-0AA0

Ordering Information

The catalog numbers listed here are for complete, non-interchangeable trip circuit breakers without lugs.

Order required lugs or connection technology separately for field installation.

All 3VA52 thermal-magnetic trip circuit breakers are CSA approved / UL listed for reverse feed applications.

For NAVAL rated thermal-magnetic trip circuit breakers, change the 13th digit of the catalog number to the number "1". (For example, a 18kA @600VAC, 150A, 3-pole, NAVAL rated 3VA52 would be catalog number 3VA5215-5ED31-1AA0)

Dimensions

Breaker	Poles	W in. (mm)	H in. (mm)	D in. (mm)	lbs.	kg
3VA52	2(3-) pole	4.1 (105)	7.3 (185)	3.3 (83)	4.1	1.9
3VA52	3-pole	4.1 (105)	7.3 (185)	3.3 (83)	4.5	2.1

Shipping Weight

[Ⓞ] Available with NAVAL/50C ratings.

Molded Case Circuit Breakers

3VA52 250A Thermal-magnetic Trip Circuit Breakers

Selection

3VA52 250A Frame, 4-pole Thermal-Magnetic Trip Unit

Cont. Ampere Rating	M-Interrupting Class (MFAS)	H-Interrupting Class (HFAS)	C-Interrupting Class (CFAS)
	Catalog Number	Catalog Number	Catalog Number
TM210 FTFM			
40	3VA5240-5ED41-0AA0	3VA5240-6ED41-0AA0	3VA5240-7ED41-0AA0
45	3VA5245-5ED41-0AA0	3VA5245-6ED41-0AA0	3VA5245-7ED41-0AA0
50	3VA5250-5ED41-0AA0	3VA5250-6ED41-0AA0	3VA5250-7ED41-0AA0
60	3VA5260-5ED41-0AA0	3VA5260-6ED41-0AA0	3VA5260-7ED41-0AA0
70	3VA5270-5ED41-0AA0	3VA5270-6ED41-0AA0	3VA5270-7ED41-0AA0
80	3VA5280-5ED41-0AA0	3VA5280-6ED41-0AA0	3VA5280-7ED41-0AA0
90	3VA5290-5ED41-0AA0	3VA5290-6ED41-0AA0	3VA5290-7ED41-0AA0
100	3VA5210-5ED41-0AA0	3VA5210-6ED41-0AA0	3VA5210-7ED41-0AA0
110	3VA5211-5ED41-0AA0	3VA5211-6ED41-0AA0	3VA5211-7ED41-0AA0
125	3VA5212-5ED41-0AA0	3VA5212-6ED41-0AA0	3VA5212-7ED41-0AA0
150	3VA5215-5ED41-0AA0	3VA5215-6ED41-0AA0	3VA5215-7ED41-0AA0
175	3VA5217-5ED41-0AA0	3VA5217-6ED41-0AA0	3VA5217-7ED41-0AA0
200	3VA5220-5ED41-0AA0	3VA5220-6ED41-0AA0	3VA5220-7ED41-0AA0
225	3VA5222-5ED41-0AA0	3VA5222-6ED41-0AA0	3VA5222-7ED41-0AA0
250	3VA5225-5ED41-0AA0	3VA5225-6ED41-0AA0	3VA5225-7ED41-0AA0
TM210 FTFM 100% Neutral			
90	3VA5290-5GD41-0AA0	3VA5290-6GD41-0AA0	3VA5290-7GD41-0AA0
100	3VA5210-5GD41-0AA0	3VA5210-6GD41-0AA0	3VA5210-7GD41-0AA0
110	3VA5211-5GD41-0AA0	3VA5211-6GD41-0AA0	3VA5211-7GD41-0AA0
125	3VA5212-5GD41-0AA0	3VA5212-6GD41-0AA0	3VA5212-7GD41-0AA0
150	3VA5215-5GD41-0AA0	3VA5215-6GD41-0AA0	3VA5215-7GD41-0AA0
175	3VA5217-5GD41-0AA0	3VA5217-6GD41-0AA0	3VA5217-7GD41-0AA0
200	3VA5220-5GD41-0AA0	3VA5220-6GD41-0AA0	3VA5220-7GD41-0AA0
225	3VA5222-5GD41-0AA0	3VA5222-6GD41-0AA0	3VA5222-7GD41-0AA0
250	3VA5225-5GD41-0AA0	3VA5225-6GD41-0AA0	3VA5225-7GD41-0AA0
TM230 FTAM			
70	3VA5270-5EC41-0AA0	3VA5270-6EC41-0AA0	3VA5270-7EC41-0AA0
80	3VA5280-5EC41-0AA0	3VA5280-6EC41-0AA0	3VA5280-7EC41-0AA0
90	3VA5290-5EC41-0AA0	3VA5290-6EC41-0AA0	3VA5290-7EC41-0AA0
100	3VA5210-5EC41-0AA0	3VA5210-6EC41-0AA0	3VA5210-7EC41-0AA0
110	3VA5211-5EC41-0AA0	3VA5211-6EC41-0AA0	3VA5211-7EC41-0AA0
125	3VA5212-5EC41-0AA0	3VA5212-6EC41-0AA0	3VA5212-7EC41-0AA0
150	3VA5215-5EC41-0AA0	3VA5215-6EC41-0AA0	3VA5215-7EC41-0AA0
175	3VA5217-5EC41-0AA0	3VA5217-6EC41-0AA0	3VA5217-7EC41-0AA0
200	3VA5220-5EC41-0AA0	3VA5220-6EC41-0AA0	3VA5220-7EC41-0AA0
225	3VA5222-5EC41-0AA0	3VA5222-6EC41-0AA0	3VA5222-7EC41-0AA0
250	3VA5225-5EC41-0AA0	3VA5225-6EC41-0AA0	3VA5225-7EC41-0AA0
TM230 FTAM 100% Neutral			
90	3VA5290-5GC41-0AA0	3VA5290-6GC41-0AA0	3VA5290-7GC41-0AA0
100	3VA5210-5GC41-0AA0	3VA5210-6GC41-0AA0	3VA5210-7GC41-0AA0
110	3VA5211-5GC41-0AA0	3VA5211-6GC41-0AA0	3VA5211-7GC41-0AA0
125	3VA5212-5GC41-0AA0	3VA5212-6GC41-0AA0	3VA5212-7GC41-0AA0
150	3VA5215-5GC41-0AA0	3VA5215-6GC41-0AA0	3VA5215-7GC41-0AA0
175	3VA5217-5GC41-0AA0	3VA5217-6GC41-0AA0	3VA5217-7GC41-0AA0
200	3VA5220-5GC41-0AA0	3VA5220-6GC41-0AA0	3VA5220-7GC41-0AA0
225	3VA5222-5GC41-0AA0	3VA5222-6GC41-0AA0	3VA5222-7GC41-0AA0
250	3VA5225-5GC41-0AA0	3VA5225-6GC41-0AA0	3VA5225-7GC41-0AA0
TM240 ATAM			
70	3VA5270-5EF41-0AA0	3VA5270-6EF41-0AA0	3VA5270-7EF41-0AA0
80	3VA5280-5EF41-0AA0	3VA5280-6EF41-0AA0	3VA5280-7EF41-0AA0
100	3VA5210-5EF41-0AA0	3VA5210-6EF41-0AA0	3VA5210-7EF41-0AA0
125	3VA5212-5EF41-0AA0	3VA5212-6EF41-0AA0	3VA5212-7EF41-0AA0
150	3VA5215-5EF41-0AA0	3VA5215-6EF41-0AA0	3VA5215-7EF41-0AA0
175	3VA5217-5EF41-0AA0	3VA5217-6EF41-0AA0	3VA5217-7EF41-0AA0
200	3VA5220-5EF41-0AA0	3VA5220-6EF41-0AA0	3VA5220-7EF41-0AA0
250	3VA5225-5EF41-0AA0	3VA5225-6EF41-0AA0	3VA5225-7EF41-0AA0
TM240 ATAM 100% Neutral			
100	3VA5210-5GF41-0AA0	3VA5210-6GF41-0AA0	3VA5210-7GF41-0AA0
125	3VA5212-5GF41-0AA0	3VA5212-6GF41-0AA0	3VA5212-7GF41-0AA0
150	3VA5215-5GF41-0AA0	3VA5215-6GF41-0AA0	3VA5215-7GF41-0AA0
175	3VA5217-5GF41-0AA0	3VA5217-6GF41-0AA0	3VA5217-7GF41-0AA0
200	3VA5220-5GF41-0AA0	3VA5220-6GF41-0AA0	3VA5220-7GF41-0AA0
250	3VA5225-5GF41-0AA0	3VA5225-6GF41-0AA0	3VA5225-7GF41-0AA0

Molded Case Circuit Breakers

3VA52 250A Thermal-magnetic Trip Circuit Breakers

Technical information

Interrupting Ratings for 3VA52

Interrupting Class	Breaker Type	RMS Symmetrical Amperes (kA)							
		Volts AC (50/60 Hz)						Volts DC	
		240	480Y/277V	480	600Y/347V	600	250	500	600 (3P)
M	MFAS	85	35	35	18	18	50	50	50
H	HFAS	100	65	65	25	25	85	85	85
C	CFAS	200	100	100	35	35	100	100	100

Trip Settings for 3VA52

TM210 - FTFM		
I _n (A)	I _l (A)	I _{tr} (A)
100	100	1000
110	110	1100
125	125	1250
150	150	1500
175	175	1750
200	200	2000
225	225	2250
250	250	2500

TM230 - FTAM							
I _n (A)	I _l (A)	I _{tr} (A)	I _{tr} (A)	I _{tr} (A)	I _{tr} (A)	I _{tr} (A)	I _{tr} (A)
100	100	500	600	700	800	900	1000
110	110	550	660	770	880	990	1100
125	125	625	750	875	1000	1125	1125
150	150	750	900	1050	1200	1350	1500
175	175	875	1050	1225	1400	1575	1750
200	200	1000	1200	1400	1600	1800	2000
225	225	1125	1350	1575	1800	2025	2250
250	250	1250	1500	1750	2000	2250	2500

Connectors for 75C Wire for 3VA52

Type	Minimum cable size	Maximum cable size	Part Number (kit of 3 lugs)
Steel wrap around (Cu cable only), single cable lugs	AWG 10	3/0	3VA9233-0JA11
	AWG 4	350 kcmil	3VA9233-0JA12
Aluminum body lug (Cu/Al cable), single cable lugs	AWG 6	350 kcmil	3VA9233-0JB12
Aluminum body lug (Cu/Al cable) with control wire tap, single cable lugs	AWG 6	350 kcmil	3VA9233-0JG12
Aluminum body lug large (Cu/Al cable) single cable lugs with 1 extended terminal cover	AWG 2	350 kcmil	3VA9233-0JJ13
Aluminum body lug large with control wire tap (Cu/Al cable) single cable lugs and 1 extended terminal cover	AWG 2	350 kcmil	3VA9233-0JC13
Aluminum body lug, 2 cables (Cu/Al cable) with control wire tap and 1 extended terminal cover	AWG 4	300 kcmil	3VA9233-0JJ22
Distribution lug, 6 Cables (Cu/Al cable) with 1 extended terminal cover	AWG 14	AWG 2	3VA9233-0JF60
Copper body lug (Cu cable only) single cable lugs	AWG 6	350 kcmil	3VA9233-0JD12
Copper body lug with control wire tap (Cu cable only) single cable lugs	AWG 6	350 kcmil	3VA9233-0JK12

See page 5-72 for internal accessory part numbers.

Internal accessories Optional equipment		3VA5 250 A 2(3)-pole & 3-pole	
Slot No.:		24 23 22 21 20 19 18 17 16 15 14	
Auxiliary switch	Type		
Auxiliary switch	AUX_HQ	x x x x	x x x x
	AUX_HQ_el	x x x x	x x x x
	AUX_HP	x x	x x
Leading changeover switch	LCS_HQ		x
	LCS_HQ_el		x
	LCS_HP		x
Auxiliary switch	Type		
Trip alarm switch	TAS_HQ	x x	x x
	TAS_HQ_el	x x	x x
	TAS_HP	x	x
Auxiliary switch	Type		
Shunt trip flexible	STF	x	
Shunt trip left	STL	x	
Undervoltage release	UVR	x	
Universal release	UVI	x	
Other			
Cylinder lock (type Ronis)			x

Molded Case Circuit Breakers

3VA62 250A Electronic Trip Circuit Breakers

Selection



3VA62 250A 3-Pole

Ordering Information

The catalog numbers listed below are for complete, non-interchangeable trip circuit breakers without lugs.

Order required lugs or connection technology separately for field installation.

All 3VA62 electronic trip circuit breakers are CSA approved and UL listed for reverse feed applications.

All 3VA62 electronic trip circuit breakers are available with 100% ratings.

For 100% rated electronic trip circuit breakers, change the 13th digit of the catalog number to the number "2". (For example, a 18kA @600VAC, 100A, 3-pole, 100% rated 3VA62 would be catalog number 3VA6210-5HL31-2AA0) Requires the use of copper lugs — see lug table below.

All 3VA6 circuit breakers are certified to CSA C22.2 No 5, and UL 489 Supplement SB, are marked "Naval", and are suitable for use at 50C.

3VA62 250A Frame 3-Pole Electronic Trip Unit

Continuous Ampere	M-Interrupting Class (MFAE-Y)	H-Interrupting Class (HFAE-Y)	C-Interrupting Class (CFAE-Y)	L-Interrupting Class (LFAE-Y)	E-Interrupting Class (EFAE)
	Catalogue Number	Catalogue Number	Catalogue Number	Catalogue Number	Catalog Number
ETU320 LI with dials					
100	3VA6210-5HL31-0AA0	3VA6210-6HL31-0AA0	3VA6210-7HL31-0AA0	3VA6210-8HL31-0AA0	—
250	3VA6225-5HL31-0AA0	3VA6225-6HL31-0AA0	3VA6225-7HL31-0AA0	3VA6225-8HL31-0AA0	3VA6225-0HL31-0AA0
ETU330 LIG with dials					
100	3VA6210-5HM31-0AA0	3VA6210-6HM31-0AA0	3VA6210-7HM31-0AA0	3VA6210-8HM31-0AA0	—
250	3VA6225-5HM31-0AA0	3VA6225-6HM31-0AA0	3VA6225-7HM31-0AA0	3VA6225-8HM31-0AA0	3VA6225-0HM31-0AA0
ETU350 LSI with dials					
100	3VA6210-5HN31-0AA0	3VA6210-6HN31-0AA0	3VA6210-7HN31-0AA0	3VA6210-8HN31-0AA0	—
250	3VA6225-5HN31-0AA0	3VA6225-6HN31-0AA0	3VA6225-7HN31-0AA0	3VA6225-8HN31-0AA0	3VA6225-0HN31-0AA0
ETU550 LSI with LCD					
100	3VA6210-5JP31-0AA0	3VA6210-6JP31-0AA0	3VA6210-7JP31-0AA0	3VA6210-8JP31-0AA0	—
250	3VA6225-5JP31-0AA0	3VA6225-6JP31-0AA0	3VA6225-7JP31-0AA0	3VA6225-8JP31-0AA0	—
ETU556 LSI(G Alarm) with LCD					
100	3VA6210-5JT31-0AA0	3VA6210-6JT31-0AA0	3VA6210-7JT31-0AA0	3VA6210-8JT31-0AA0	—
250	3VA6225-5JT31-0AA0	3VA6225-6JT31-0AA0	3VA6225-7JT31-0AA0	3VA6225-8JT31-0AA0	—
ETU560 LSI(G) with LCD					
100	3VA6210-5JQ31-0AA0	3VA6210-6JQ31-0AA0	3VA6210-7JQ31-0AA0	3VA6210-8JQ31-0AA0	—
250	3VA6225-5JQ31-0AA0	3VA6225-6JQ31-0AA0	3VA6225-7JQ31-0AA0	3VA6225-8JQ31-0AA0	—
ETU820 LI with LCD and Metering					
100	3VA6210-5KL31-0AA0	3VA6210-6KL31-0AA0	3VA6210-7KL31-0AA0	3VA6210-8KL31-0AA0	—
250	3VA6225-5KL31-0AA0	3VA6225-6KL31-0AA0	3VA6225-7KL31-0AA0	3VA6225-8KL31-0AA0	—
ETU830 LIG with LCD and Metering					
100	3VA6210-5KM31-0AA0	3VA6210-6KM31-0AA0	3VA6210-7KM31-0AA0	3VA6210-8KM31-0AA0	—
250	3VA6225-5KM31-0AA0	3VA6225-6KM31-0AA0	3VA6225-7KM31-0AA0	3VA6225-8KM31-0AA0	—
ETU850 LSI with LCD and Metering					
100	3VA6210-5KP31-0AA0	3VA6210-6KP31-0AA0	3VA6210-7KP31-0AA0	3VA6210-8KP31-0AA0	—
250	3VA6225-5KP31-0AA0	3VA6225-6KP31-0AA0	3VA6225-7KP31-0AA0	3VA6225-8KP31-0AA0	—
ETU856 LSI(G Alarm) with LCD and Metering					
100	3VA6210-5KT31-0AA0	3VA6210-6KT31-0AA0	3VA6210-7KT31-0AA0	3VA6210-8KT31-0AA0	—
250	3VA6225-5KT31-0AA0	3VA6225-6KT31-0AA0	3VA6225-7KT31-0AA0	3VA6225-8KT31-0AA0	3VA6225-0KT31-0AA0
ETU860 LSI(G) with LCD and Metering					
100	3VA6210-5KQ31-0AA0	3VA6210-6KQ31-0AA0	3VA6210-7KQ31-0AA0	3VA6210-8KQ31-0AA0	—
250	3VA6225-5KQ31-0AA0	3VA6225-6KQ31-0AA0	3VA6225-7KQ31-0AA0	3VA6225-8KQ31-0AA0	3VA6225-0KQ31-0AA0

Molded Case Circuit Breakers

3VA62 250A Electronic Trip Circuit Breakers

Selection



3VA62 250A 4-Pole

Ordering Information

The catalog numbers listed below are for complete, non-interchangeable trip circuit breakers without lugs.

Order required lugs or connection technology separately for field installation.

All 3VA62 electronic trip circuit breakers are CSA approved and UL listed for reverse feed applications.

All 3VA62 electronic trip circuit breakers are available with 100% ratings.

For 100% rated electronic trip circuit breakers, change the 13th digit of the catalog number to the number "2". (For example, a 18kA @600VAC, 100A, 3-pole, 100% rated 3VA62 would be catalog number 3VA6210-5HL31-2AA0) Requires the use of copper lugs — see lug table below.

All 3VA6 circuit breakers are certified to CSA C22.2 No 5, and UL 489 Supplement SB, are marked "Naval", and are suitable for use at 50C.

3VA62 250A Frame 4-Pole Electronic Trip Unit

Continuous Ampere	M-Interrupting Class (MFAE-Y)	H-Interrupting Class (HFAE-Y)	C-Interrupting Class (CFAE-Y)	L-Interrupting Class (LFAE-Y)	E-Interrupting Class (EFAE)
	Catalog Number	Catalog Number	Catalog Number	Catalog Number	Catalog Number
ETU320 LI with dials					
100	3VA6210-5HL41-0AA0	3VA6210-6HL41-0AA0	3VA6210-7HL41-0AA0	3VA6210-8HL41-0AA0	—
250	3VA6225-5HL41-0AA0	3VA6225-6HL41-0AA0	3VA6225-7HL41-0AA0	3VA6225-8HL41-0AA0	3VA6225-0HL41-0AA0
ETU330 LIG with dials					
100	3VA6210-5HM41-0AA0	3VA6210-6HM41-0AA0	3VA6210-7HM41-0AA0	3VA6210-8HM41-0AA0	—
250	3VA6225-5HM41-0AA0	3VA6225-6HM41-0AA0	3VA6225-7HM41-0AA0	3VA6225-8HM41-0AA0	3VA6225-0HM41-0AA0
ETU350 LSI with dials					
100	3VA6210-5HN41-0AA0	3VA6210-6HN41-0AA0	3VA6210-7HN41-0AA0	3VA6210-8HN41-0AA0	—
250	3VA6225-5HN41-0AA0	3VA6225-6HN41-0AA0	3VA6225-7HN41-0AA0	3VA6225-8HN41-0AA0	3VA6225-0HN41-0AA0
ETU550 LSI with LCD					
100	3VA6210-5JP41-0AA0	3VA6210-6JP41-0AA0	3VA6210-7JP41-0AA0	3VA6210-8JP41-0AA0	—
250	3VA6225-5JP41-0AA0	3VA6225-6JP41-0AA0	3VA6225-7JP41-0AA0	3VA6225-8JP41-0AA0	—
ETU556 LSI(G Alarm) with LCD					
100	3VA6210-5JT41-0AA0	3VA6210-6JT41-0AA0	3VA6210-7JT41-0AA0	3VA6210-8JT41-0AA0	—
250	3VA6225-5JT41-0AA0	3VA6225-6JT41-0AA0	3VA6225-7JT41-0AA0	3VA6225-8JT41-0AA0	—
ETU560 LSI(G) with LCD					
100	3VA6210-5JQ41-0AA0	3VA6210-6JQ41-0AA0	3VA6210-7JQ41-0AA0	3VA6210-8JQ41-0AA0	—
250	3VA6225-5JQ41-0AA0	3VA6225-6JQ41-0AA0	3VA6225-7JQ41-0AA0	3VA6225-8JQ41-0AA0	—
ETU820 LI with LCD and Metering					
100	3VA6210-5KL41-0AA0	3VA6210-6KL41-0AA0	3VA6210-7KL41-0AA0	3VA6210-8KL41-0AA0	—
250	3VA6225-5KL41-0AA0	3VA6225-6KL41-0AA0	3VA6225-7KL41-0AA0	3VA6225-8KL41-0AA0	—
ETU830 LIG with LCD and Metering					
100	3VA6210-5KM41-0AA0	3VA6210-6KM41-0AA0	3VA6210-7KM41-0AA0	3VA6210-8KM41-0AA0	—
250	3VA6225-5KM41-0AA0	3VA6225-6KM41-0AA0	3VA6225-7KM41-0AA0	3VA6225-8KM41-0AA0	—
ETU850 LSI with LCD and Metering					
100	3VA6210-5KP41-0AA0	3VA6210-6KP41-0AA0	3VA6210-7KP41-0AA0	3VA6210-8KP41-0AA0	—
250	3VA6225-5KP41-0AA0	3VA6225-6KP41-0AA0	3VA6225-7KP41-0AA0	3VA6225-8KP41-0AA0	—
ETU856 LSI(G Alarm) with LCD and Metering					
100	3VA6210-5KT41-0AA0	3VA6210-6KT41-0AA0	3VA6210-7KT41-0AA0	3VA6210-8KT41-0AA0	—
250	3VA6225-5KT41-0AA0	3VA6225-6KT41-0AA0	3VA6225-7KT41-0AA0	3VA6225-8KT41-0AA0	3VA6225-0KT41-0AA0
ETU860 LSI(G) with LCD and Metering					
100	3VA6210-5KQ41-0AA0	3VA6210-6KQ41-0AA0	3VA6210-7KQ41-0AA0	3VA6210-8KQ41-0AA0	—
250	3VA6225-5KQ41-0AA0	3VA6225-6KQ41-0AA0	3VA6225-7KQ41-0AA0	3VA6225-8KQ41-0AA0	3VA6225-0KQ41-0AA0

Molded Case Circuit Breakers

3VA62 250A Electronic Trip Circuit Breakers

Technical information

Connectors for 75C wire for 3VA62

Type	Minimum cable size	Maximum cable size	Part Number (kit of 3 lugs)	Part Number (kit of 4 lugs)
Steel Wrap around (Cu cable only) single cable lugs	AWG 10	3/0	3VA9143-0JA12	3VA9144-0JA12
	AWG 4	350 kcmil	3VA9243-0JA12	3VA9244-0JA12
Aluminum Body Lug (Cu/Al cable) single cable lugs	AWG 14	1/0	3VA9143-0JB11	3VA9144-0JB11
	AWG 6	350 kcmil	3VA9243-0JB12	3VA9244-0JB12
Aluminum body lug with control wire tap (Cu/Al cable) single cable lugs	AWG 14	1/0	3VA9143-0JG11	3VA9144-0JG11
	AWG 6	350 kcmil	3VA9243-0JG12	3VA9244-0JG12
Aluminum body lug large (Cu/Al cable) single cable lugs and 1 ext'd terminal cover	AWG 2	350 kcmil	3VA9243-0JJ13	3VA9244-0JJ13
Aluminum body lug large with control wire tap (Cu/Al cable) single cable lugs and 1 extended terminal cover	AWG 2	350 kcmil	3VA9243-0JC13	3VA9244-0JC13
Aluminum body lug, 2 cables (Cu/Al cable) with 1 extended terminal cover	AWG 4	300 kcmil	3VA9243-0JJ22	3VA9244-0JJ22
Aluminum body lug, 2 cables (Cu/Al cable) with control wire tap and 1 extended terminal cover	AWG 4	300 kcmil	3VA9243-0JC22	3VA9244-0JC22
Distribution lug, 6 Cables (Cu/Al cable) with 1 extended terminal cover	AWG 14	AWG 2	3VA9243-0JF60	3VA9244-0JF60
Copper body lug (Cu cable only) single cable lugs (meets requirements for 100% rated breakers)	AWG 14	1/0	3VA9143-0JD11	3VA9144-0JD11
	AWG 6	350 kcmil	3VA9243-0JD12	3VA9244-0JD12
Copper body lug (Cu cable only) with control wire tap single cable lugs	AWG 14	1/0	3VA9143-0JK11	3VA9144-0JK11
	AWG 6	350 kcmil	3VA9243-0JK12	3VA9244-0JK12

Interrupting Ratings for 3VA62

Interrupting Class	Breaker Type	RMS Symmetrical Amperes (kA)				
		Volts AC (50/60 Hz)				
		240	480Y/277V	480	600Y/347V	600
M	MFAE-Y	100	35	35	18	—
H	HFAE-Y	100	65	65	22	—
C	CFAE-Y	200	100	100	35	—
L	LFAE-Y	200	150	150	50	—
E	EFAE-Y	—	200	200	100	—

Dimensions

Breaker	Poles	W in. (mm)	H in. (mm)	D in. (mm)	lbs.	kg
3VA62	3	4.1 (105)	7.8 (198)	3.4 (86)	5.5	2.5
3VA62	4	5.5 (140)	7.8 (198)	3.4 (86)	7.1	3.2

Shipping Weight

Molded Case Circuit Breakers

3VA62 250A Electronic Trip Circuit Breakers

Technical information

Trip Settings for 3VA62

ETU320-LI, ETU330-LIG, ETU350-LSI

Continuous Amperage	LI, LIG, LSI			LSI		LIG	LI, LIG, LSI 4P only
	I _n (Amp)	t _{in} (sec) (L)	I _n (Amp) (I)①	I _{cr} =xI _r (Amp) (S)	t _{cr} (sec) (S)		
100	40 - 100	0.5 - 17	150-1200	1.5 - 10	0.08 - 0.4	20 - 100	0.5 - 1 / OFF
250	100 - 250	0.5 - 13	375-2500	1.5 - 10		50 - 250	0.5 - 1 / OFF

① I_n for ETU350 is fixed at 12X I_n.

ETU550-LSI, ETU556 LSI(A), ETU560-LSIG, ETU820-LI, ETU830-LIG, ETU850-LSI, ETU856 LSI(A), ETU860-LSIG

Continuous Amperage	LI, LIG, LSI, LSIG, LSI(G)			LSI, LSIG, LSI(G)		LIG, LSIG, LSI(G)		LSI 3P with External CT	LI, LIG, LSI, LSIG, LSI(G) 4P only
	I _n (Amp)	t _{in} (sec) (L)	I _n (Amp) (I)	I _{cr} (Amp) (S)	t _{cr} (sec) (S)	I _n (Amp) (G)	t _n (G)	I _n =xI _r (Amp)	I _n (Amp)
100	40 - 100	0.5 - 25	150-1200	60 - 1000	0.05 - 0.5	20 - 100	0.05 - 0.8	20 - 160 / OFF	20 - 160 / OFF
250	100 - 250	0.5 - 13	375-2500	150 - 2500		50 - 250		50 - 400 / OFF	50 - 250 / OFF

For specific trip settings refer to the Electronic Trip Unit section of the 3VA Systems Manual, which can be found in the document download center at https://www.siemens.com/download?BTLV_50412

Internal accessories Optional equipment	Slot No.:	3VA6 150/250 A 3-pole							3VA6 150/250 A 4-pole											
		24	23	22	21	250 A	11	12	13	14	24	23	22	21	250 A	11	12	13	14	
Auxiliary switch	Type																			
Auxiliary switch	AUX_HQ	x	x	x	x		x	x	x	x		x	x	x	x		x	x	x	x
	AUX_HQ_el	x	x	x	x		x	x	x	x		x	x	x	x		x	x	x	x
	AUX_HP						x					x					x			
Leading changeover switch	LCS_HQ										x						x			
	LCS_HQ_el										x						x			
	LCS_HP										x						x			
Auxiliary switch	Type																			
Trip alarm switch	TAS_HQ			x	x			x	x					x	x					
	TAS_HQ_el			x	x			x	x					x	x					
	TAS_HP				x									x						
Electrical alarm switch	EAS_HQ																			x
	EAS_HQ_el																			x
Auxiliary switch	Type																			
Shunt trip flexible	STF			x					x					x						
Shunt trip left	STL			x										x						
Undervoltage release	UVR			x										x						
Universal release	UVI			x										x						
ETU/communication	Type																			
Communication module Breaker data server	COM060																			x
24 V module																				x
Other																				
Cylinder lock (type Ronis)																				x

See page 5-72 for internal accessory part numbers.

Molded Case Circuit Breakers

3VA53 400A Thermal-magnetic Trip Circuit Breakers

Selection

3VA53 400A Frame, 2-(3)Pole Frame,
Thermal-Magnetic Trip Unit

Cont. Ampere Rating	M-Interrupting Class (MJAS)	H-Interrupting Class (HJAS)	C-Interrupting Class (CJAS)
	Catalog Number	Catalog Number	Catalog Number
TM230 FTAM			
200	3VA5320-5EC61-0AA0	3VA5320-6EC61-0AA0	3VA5320-7EC61-0AA0
225	3VA5322-5EC61-0AA0	3VA5322-6EC61-0AA0	3VA5322-7EC61-0AA0
250	3VA5325-5EC61-0AA0	3VA5325-6EC61-0AA0	3VA5325-7EC61-0AA0
300	3VA5330-5EC61-0AA0	3VA5330-6EC61-0AA0	3VA5330-7EC61-0AA0
350	3VA5335-5EC61-0AA0	3VA5335-6EC61-0AA0	3VA5335-7EC61-0AA0
400	3VA5340-5EC61-0AA0	3VA5340-6EC61-0AA0	3VA5340-7EC61-0AA0

3VA53 400A Frame, 3-Pole Frame,
Thermal-Magnetic Trip Unit

Cont. Ampere Rating	M-Interrupting Class (MJAS)	H-Interrupting Class (HJAS)	C-Interrupting Class (CJAS)
	Catalog Number	Catalog Number	Catalog Number
TM230 FTAM [Ⓞ]			
200	3VA5320-5EC31-0AA0	3VA5320-6EC31-0AA0	3VA5320-7EC31-0AA0
225	3VA5322-5EC31-0AA0	3VA5322-6EC31-0AA0	3VA5322-7EC31-0AA0
250	3VA5325-5EC31-0AA0	3VA5325-6EC31-0AA0	3VA5325-7EC31-0AA0
300	3VA5330-5EC31-0AA0	3VA5330-6EC31-0AA0	3VA5330-7EC31-0AA0
350	3VA5335-5EC31-0AA0	3VA5335-6EC31-0AA0	3VA5335-7EC31-0AA0
400	3VA5340-5EC31-0AA0	3VA5340-6EC31-0AA0	3VA5340-7EC31-0AA0

Cont. Ampere Rating	M-Interrupting Class (MJAS)	H-Interrupting Class (HJAS)	C-Interrupting Class (CJAS)
	Catalog Number	Catalog Number	Catalog Number
TM240 ATAM			
200	3VA5320-5EF31-0AA0	3VA5320-6EF31-0AA0	3VA5320-7EF31-0AA0
225	3VA5322-5EF31-0AA0	3VA5322-6EF31-0AA0	3VA5322-7EF31-0AA0
250	3VA5325-5EF31-0AA0	3VA5325-6EF31-0AA0	3VA5325-7EF31-0AA0
300	3VA5330-5EF31-0AA0	3VA5330-6EF31-0AA0	3VA5330-7EF31-0AA0
350	3VA5335-5EF31-0AA0	3VA5335-6EF31-0AA0	3VA5335-7EF31-0AA0
400	3VA5340-5EF31-0AA0	3VA5340-6EF31-0AA0	3VA5340-7EF31-0AA0



3VA53 400A 3-Pole

Ordering Information

The catalog numbers listed here are for complete, non-interchangeable trip circuit breakers without lugs.

Order required lugs or connection technology separately for field installation.

All 3VA53 thermal-magnetic trip circuit breakers are CSA approved and UL listed for reverse feed applications.

For NAVAL rated thermal-magnetic trip circuit breakers, change the 13th digit of the catalog number to the number "1". (For example, a 18kA @600VAC, 400A, 3-pole, rated 3VA53 would be catalog number 3VA5340-5EC31-1AA0)

Dimensions

Shipping Weight

Breaker	Poles	W in. (mm)	H in. (mm)	D in. (mm)	lbs.	kg
3VA53	3	6.4 (162)	10.3 (262)	6.7 (170)	11.5	5.2
3VA53	4	8.2 (208)	10.3 (262)	6.7 (170)	15.0	6.8

Interrupting Ratings for 3VA53

Interrupting Class	Breaker Type	RMS Symmetrical Amperes (kA)									
		Volts AC (50/60 Hz)					Volts DC				
		240	480Y/ 277V	480	600Y/ 347V	600	250 (2P)	600 (3P)	750 (3P)	750 (4P)	1000 (4P)
M	MJAS	65	35	35	18	18	50	50	6	50	6
H	HJAS	100	65	65	25	25	85	85	6	85	6
C	CJAS	200	100	100	35	35	100	100	10	100	10

Ⓞ Available with NAVAL/50C ratings.

Molded Case Circuit Breakers

3VA53 400A Thermal-magnetic Trip Circuit Breakers

Selection

3VA53 400A Frame, 4-Pole Frame,
Thermal-Magnetic Trip Unit

Cont. Ampere Rating	M-Interrupting Class (MJAS)	H-Interrupting Class (HJAS)	C-Interrupting Class (CJAS)
	Catalog Number	Catalog Number	Catalog Number

TM230 FTAM Unprotected Neutral

200	3VA5320-5EC41-0AA0	3VA5320-6EC41-0AA0	3VA5320-7EC41-0AA0
225	3VA5322-5EC41-0AA0	3VA5322-6EC41-0AA0	3VA5322-7EC41-0AA0
250	3VA5325-5EC41-0AA0	3VA5325-6EC41-0AA0	3VA5325-7EC41-0AA0
300	3VA5330-5EC41-0AA0	3VA5330-6EC41-0AA0	3VA5330-7EC41-0AA0
350	3VA5335-5EC41-0AA0	3VA5335-6EC41-0AA0	3VA5335-7EC41-0AA0
400	3VA5340-5EC41-0AA0	3VA5340-6EC41-0AA0	3VA5340-7EC41-0AA0

TM240 ATAM Unprotected Neutral

200	3VA5320-5EF41-0AA0	3VA5320-6EF41-0AA0	3VA5320-7EF41-0AA0
225	3VA5322-5EF41-0AA0	3VA5322-6EF41-0AA0	3VA5322-7EF41-0AA0
250	3VA5325-5EF41-0AA0	3VA5325-6EF41-0AA0	3VA5325-7EF41-0AA0
300	3VA5330-5EF41-0AA0	3VA5330-6EF41-0AA0	3VA5330-7EF41-0AA0
350	3VA5335-5EF41-0AA0	3VA5335-6EF41-0AA0	3VA5335-7EF41-0AA0
400	3VA5340-5EF41-0AA0	3VA5340-6EF41-0AA0	3VA5340-7EF41-0AA0

TM230 FTAM 100% Neutral

200	3VA5320-5GC41-0AA0	3VA5320-6GC41-0AA0	3VA5320-7GC41-0AA0
225	3VA5322-5GC41-0AA0	3VA5322-6GC41-0AA0	3VA5322-7GC41-0AA0
250	3VA5325-5GC41-0AA0	3VA5325-6GC41-0AA0	3VA5325-7GC41-0AA0
300	3VA5330-5GC41-0AA0	3VA5330-6GC41-0AA0	3VA5330-7GC41-0AA0
350	3VA5335-5GC41-0AA0	3VA5335-6GC41-0AA0	3VA5335-7GC41-0AA0
400	3VA5340-5GC41-0AA0	3VA5340-6GC41-0AA0	3VA5340-7GC41-0AA0

TM240 ATAM 100% Neutral

200	3VA5320-5GF41-0AA0	3VA5320-6GF41-0AA0	3VA5320-7GF41-0AA0
225	3VA5322-5GF41-0AA0	3VA5322-6GF41-0AA0	3VA5322-7GF41-0AA0
250	3VA5325-5GF41-0AA0	3VA5325-6GF41-0AA0	3VA5325-7GF41-0AA0
300	3VA5330-5GF41-0AA0	3VA5330-6GF41-0AA0	3VA5330-7GF41-0AA0
350	3VA5335-5GF41-0AA0	3VA5335-6GF41-0AA0	3VA5335-7GF41-0AA0
400	3VA5340-5GF41-0AA0	3VA5340-6GF41-0AA0	3VA5340-7GF41-0AA0



3VA53 400A 4-Pole

Dimensions

Breaker	Poles	W in. (mm)	H in. (mm)	D in. (mm)	lbs.	kg
3VA53	3	6.4 (162)	10.3 (262)	6.7 (170)	11.5	5.2
3VA53	4	8.2 (208)	10.3 (262)	6.7 (170)	15.0	6.8

Shipping Weight

Interrupting Ratings for 3VA53

Interrupting Class	Breaker Type	RMS Symmetrical Amperes (kA)							
		Volts AC (50/60 Hz)				Volts DC			
		240	480Y/277V	480	600Y/347V	600	250	500	600 (3P)
M	MJAS	65	35	35	18	18	50	50	50
H	HJAS	100	65	65	25	25	85	85	85
C	CJAS	200	100	100	35	35	100	100	100

Internal accessories		Slot No.:
Optional equipment		Type
Auxiliary switch	AUX_HQ	x x x x x
Auxiliary switch	AUX_HQ_el	x x x x x
	AUX_HP	x x
Leading changeover switch	LCS_HQ	x
	LCS_HQ_el	x
	LCS_HP	x
Auxiliary switch	TAS_HQ	x x
Trip alarm switch	TAS_HQ_el	x x
	TAS_HP	x
Auxiliary switch	STF	x
Shunt trip flexible	STL	x
Shunt trip left	UVR	x
Undervoltage release	UVI	x
Universal release		
Other		
Cylinder lock (type Ronis)		x

3VA5 400/600 A 3 & 4-pole														
25	24	23	22	21	11	12	13	14	15					
x	x	x	x	x		x	x	x	x	x	x	x	x	x
x	x	x	x	x		x	x	x	x	x	x	x	x	x
										x	x			

Molded Case Circuit Breakers

3VA63 400A Electronic Trip Circuit Breakers

Selection



3VA63 400A 3-Pole

Ordering Information

The catalog numbers listed below are for complete, non-interchangeable trip circuit breakers without lugs.

Order required lugs or connection technology separately for field installation.

All 3VA63 electronic trip circuit breakers are CSA approved and UL listed for reverse feed applications.

3VA63 electronic trip circuit breakers are available with 100% ratings (250A only).

For 100% rated electronic trip circuit breakers, change the 13th digit of the catalog number to the number "2". (For example, a 18kA @600VAC, 250A, 3-pole, 100% rated 3VA63 would be catalog number 3VA6325-5HL31-2AA0) Requires the use of copper lugs — see lug table below.

All 3VA6 circuit breakers are certified to CSA C22.2 No 5, and UL 489 Supplement SB, are marked "Naval", and are suitable for use at 50C.

3VA63 400A Frame 3-Pole Electronic Trip Unit

Continuous Ampere	M-Interrupting Class (MJAE)	H-Interrupting Class (HJAE)	C-Interrupting Class (CJAE)	L-Interrupting Class (LJAE)	E-Interrupting Class (EJAE)
	Catalog Number	Catalog Number	Catalog Number	Catalog Number	Catalog Number
ETU320 LI with dials					
250	3VA6325-5HL31-0AA0	3VA6325-6HL31-0AA0	3VA6325-7HL31-0AA0	3VA6325-8HL31-0AA0	3VA6325-0HL31-0AA0
400	3VA6340-5HL31-0AA0	3VA6340-6HL31-0AA0	3VA6340-7HL31-0AA0	3VA6340-8HL31-0AA0	3VA6340-0HL31-0AA0
ETU330 LIG with dials					
250	3VA6325-5HM31-0AA0	3VA6325-6HM31-0AA0	3VA6325-7HM31-0AA0	3VA6325-8HM31-0AA0	3VA6325-0HM31-0AA0
400	3VA6340-5HM31-0AA0	3VA6340-6HM31-0AA0	3VA6340-7HM31-0AA0	3VA6340-8HM31-0AA0	3VA6340-0HM31-0AA0
ETU350 LSI with dials					
250	3VA6325-5HN31-0AA0	3VA6325-6HN31-0AA0	3VA6325-7HN31-0AA0	3VA6325-8HN31-0AA0	3VA6325-0HN31-0AA0
400	3VA6340-5HN31-0AA0	3VA6340-6HN31-0AA0	3VA6340-7HN31-0AA0	3VA6340-8HN31-0AA0	3VA6340-0HN31-0AA0
ETU550 LSI with LCD					
250	3VA6325-5JP31-0AA0	3VA6325-6JP31-0AA0	3VA6325-7JP31-0AA0	3VA6325-8JP31-0AA0	—
400	3VA6340-5JP31-0AA0	3VA6340-6JP31-0AA0	3VA6340-7JP31-0AA0	3VA6340-8JP31-0AA0	—
ETU556 LSI(G Alarm) with LCD					
250	3VA6325-5JT31-0AA0	3VA6325-6JT31-0AA0	3VA6325-7JT31-0AA0	3VA6325-8JT31-0AA0	—
400	3VA6340-5JT31-0AA0	3VA6340-6JT31-0AA0	3VA6340-7JT31-0AA0	3VA6340-8JT31-0AA0	—
ETU560 LSI(G) with LCD					
250	3VA6325-5JQ31-0AA0	3VA6325-6JQ31-0AA0	3VA6325-7JQ31-0AA0	3VA6325-8JQ31-0AA0	—
400	3VA6340-5JQ31-0AA0	3VA6340-6JQ31-0AA0	3VA6340-7JQ31-0AA0	3VA6340-8JQ31-0AA0	—
ETU820 LI with LCD and Metering					
250	3VA6325-5KL31-0AA0	3VA6325-6KL31-0AA0	3VA6325-7KL31-0AA0	3VA6325-8KL31-0AA0	—
400	3VA6340-5KL31-0AA0	3VA6340-6KL31-0AA0	3VA6340-7KL31-0AA0	3VA6340-8KL31-0AA0	—
ETU830 LIG with LCD and Metering					
250	3VA6325-5KM31-0AA0	3VA6325-6KM31-0AA0	3VA6325-7KM31-0AA0	3VA6325-8KM31-0AA0	—
400	3VA6340-5KM31-0AA0	3VA6340-6KM31-0AA0	3VA6340-7KM31-0AA0	3VA6340-8KM31-0AA0	—
ETU850 LSI with LCD and Metering					
250	3VA6325-5KP31-0AA0	3VA6325-6KP31-0AA0	3VA6325-7KP31-0AA0	3VA6325-8KP31-0AA0	—
400	3VA6340-5KP31-0AA0	3VA6340-6KP31-0AA0	3VA6340-7KP31-0AA0	3VA6340-8KP31-0AA0	—
ETU856 LSI(G Alarm) with LCD and Metering					
250	3VA6325-5KT31-0AA0	3VA6325-6KT31-0AA0	3VA6325-7KT31-0AA0	3VA6325-8KT31-0AA0	3VA6325-0KT31-0AA0
400	3VA6340-5KT31-0AA0	3VA6340-6KT31-0AA0	3VA6340-7KT31-0AA0	3VA6340-8KT31-0AA0	3VA6340-0KT31-0AA0
ETU860 LSI(G) with LCD and Metering					
250	3VA6325-5KQ31-0AA0	3VA6325-6KQ31-0AA0	3VA6325-7KQ31-0AA0	3VA6325-8KQ31-0AA0	3VA6325-0KQ31-0AA0
400	3VA6340-5KQ31-0AA0	3VA6340-6KQ31-0AA0	3VA6340-7KQ31-0AA0	3VA6340-8KQ31-0AA0	3VA6340-0KQ31-0AA0

Molded Case Circuit Breakers

3VA63 400A Electronic Trip Circuit Breakers

Selection



3VA63 400A 4-Pole

Ordering Information

The catalog numbers listed below are for complete, non-interchangeable trip circuit breakers without lugs.

Order required lugs or connection technology separately for field installation.

All 3VA63 electronic trip circuit breakers are CSA approved and UL listed for reverse feed applications.

3VA63 electronic trip circuit breakers are available with 100% ratings (250A only).

For 100% rated electronic trip circuit breakers, change the 13th digit of the catalog number to the number "2". (For example, a 18kA @600VAC, 250A, 3-pole, 100% rated 3VA63 would be catalog number 3VA6325-5HL31-2AA0) Requires the use of copper lugs — see lug table below.

All 3VA6 circuit breakers are certified to CSA C22.2 No 5, and UL 489 Supplement SB, are marked "Naval", and are suitable for use at 50C.

3VA63 400A Frame 4-Pole Electronic Trip Unit

Continuous Ampere	M-Interrupting Class (MJAE)	H-Interrupting Class (HJAE)	C-Interrupting Class (CJAE)	L-Interrupting Class (LJAE)	E-Interrupting Class (EJAE)
	Catalog Number	Catalog Number	Catalog Number	Catalog Number	Catalog Number
ETU320 LI with dials					
250	3VA6325-5HL41-0AA0	3VA6325-6HL41-0AA0	3VA6325-7HL41-0AA0	3VA6325-8HL41-0AA0	3VA6325-0HL31-0AA0
400	3VA6340-5HL41-0AA0	3VA6340-6HL41-0AA0	3VA6340-7HL41-0AA0	3VA6340-8HL41-0AA0	3VA6340-0HL31-0AA0
ETU330 LIG with dials					
250	3VA6325-5HM41-0AA0	3VA6325-6HM41-0AA0	3VA6325-7HM41-0AA0	3VA6325-8HM41-0AA0	3VA6325-0HM31-0AA0
400	3VA6340-5HM41-0AA0	3VA6340-6HM41-0AA0	3VA6340-7HM41-0AA0	3VA6340-8HM41-0AA0	3VA6340-0HM31-0AA0
ETU350 LSI with dials					
250	3VA6325-5HN41-0AA0	3VA6325-6HN41-0AA0	3VA6325-7HN41-0AA0	3VA6325-8HN41-0AA0	3VA6325-0HN31-0AA0
400	3VA6340-5HN41-0AA0	3VA6340-6HN41-0AA0	3VA6340-7HN41-0AA0	3VA6340-8HN41-0AA0	3VA6340-0HN31-0AA0
ETU550 LSI with LCD					
250	3VA6325-5JP41-0AA0	3VA6325-6JP41-0AA0	3VA6325-7JP41-0AA0	3VA6325-8JP41-0AA0	—
400	3VA6340-5JP41-0AA0	3VA6340-6JP41-0AA0	3VA6340-7JP41-0AA0	3VA6340-8JP41-0AA0	—
ETU556 LSI(G Alarm) with LCD					
250	3VA6325-5JT41-0AA0	3VA6325-6JT41-0AA0	3VA6325-7JT41-0AA0	3VA6325-8JT41-0AA0	—
400	3VA6340-5JT41-0AA0	3VA6340-6JT41-0AA0	3VA6340-7JT41-0AA0	3VA6340-8JT41-0AA0	—
ETU560 LSI(G) with LCD					
250	3VA6325-5JQ41-0AA0	3VA6325-6JQ41-0AA0	3VA6325-7JQ41-0AA0	3VA6325-8JQ41-0AA0	—
400	3VA6340-5JQ41-0AA0	3VA6340-6JQ41-0AA0	3VA6340-7JQ41-0AA0	3VA6340-8JQ41-0AA0	—
ETU820 LI with LCD and Metering					
250	3VA6325-5KL41-0AA0	3VA6325-6KL41-0AA0	3VA6325-7KL41-0AA0	3VA6325-8KL41-0AA0	—
400	3VA6340-5KL41-0AA0	3VA6340-6KL41-0AA0	3VA6340-7KL41-0AA0	3VA6340-8KL41-0AA0	—
ETU830 LIG with LCD and Metering					
250	3VA6325-5KM41-0AA0	3VA6325-6KM41-0AA0	3VA6325-7KM41-0AA0	3VA6325-8KM41-0AA0	—
400	3VA6340-5KM41-0AA0	3VA6340-6KM41-0AA0	3VA6340-7KM41-0AA0	3VA6340-8KM41-0AA0	—
ETU850 LSI with LCD and Metering					
250	3VA6325-5KP41-0AA0	3VA6325-6KP41-0AA0	3VA6325-7KP41-0AA0	3VA6325-8KP41-0AA0	—
400	3VA6340-5KP41-0AA0	3VA6340-6KP41-0AA0	3VA6340-7KP41-0AA0	3VA6340-8KP41-0AA0	—
ETU856 LSI(G Alarm) with LCD and Metering					
250	3VA6325-5KT41-0AA0	3VA6325-6KT41-0AA0	3VA6325-7KT41-0AA0	3VA6325-8KT41-0AA0	3VA6325-0KT31-0AA0
400	3VA6340-5KT41-0AA0	3VA6340-6KT41-0AA0	3VA6340-7KT41-0AA0	3VA6340-8KT41-0AA0	3VA6340-0KT31-0AA0
ETU860 LSI(G) with LCD and Metering					
250	3VA6325-5KQ41-0AA0	3VA6325-6KQ41-0AA0	3VA6325-7KQ41-0AA0	3VA6325-8KQ41-0AA0	3VA6325-0KQ31-0AA0
400	3VA6340-5KQ41-0AA0	3VA6340-6KQ41-0AA0	3VA6340-7KQ41-0AA0	3VA6340-8KQ41-0AA0	3VA6340-0KQ31-0AA0

Molded Case Circuit Breakers

3VA63 400A Electronic Trip Circuit Breakers

Technical information

Connectors for 75C wire for 3VA63

Type	Minimum cable size	Maximum cable size	Part Number (kit of 3 lugs)	Part Number (kit of 4 lugs)
Steel wrap around (Cu cable only) single cable lugs	1/0	500 kcmil	3VA9473-0JA13	3VA9474-0JA13
Aluminum body lug (Cu/Al cable) single cable lugs	AWG 1	600 kcmil	3VA9373-0JB13	3VA9374-0JB13
Aluminum body lug with control wire tap (Cu/Al cable) single cable lugs	AWG 1	600 kcmil	3VA9373-0JG13	3VA9374-0JG13
Aluminum body lug, 2 cables (Cu/Al cable) with 1 extended terminal cover	2/0	600 kcmil	3VA9473-0JJ23	3VA9474-0JJ23
Aluminum body lug, 2 cables (Cu/Al cable) with control wire tap and 1 extended terminal cover	2/0	600 kcmil	3VA9473-0JC23	3VA9474-0JC23
Distribution lug, 6 Cables (Cu/Al cable) with 1 extended terminal cover	AWG 14	AWG 2	3VA9373-0JF60	3VA9374-0JF60
Copper body lug (Cu cable only) single cable lugs (meets requirements for 100% rated breakers)	AWG 1	600 kcmil	3VA9373-0JD13	3VA9374-0JD13
Copper body lug (Cu cable only) with control wire tap single cable lugs	AWG 1	600 kcmil	3VA9373-0JK13	3VA9374-0JK13
Copper body lug, 2 cables (Cu cable only) with 1 extended terminal cover (meets requirements for 100% rated breakers)	2/0	600 kcmil	3VA9473-0JE23	3VA9474-0JE23
Copper body lug, 2 cables (Cu cable only) with control wire tap and 1 extended terminal cover	2/0	600 kcmil	3VA9473-0JL23	3VA9474-0JL23

Interrupting Ratings for 3VA63

Interrupting Class	Breaker Type	RMS Symmetrical Amperes (kA)				
		Volts AC (50/60 Hz)				
		240	480Y/277V	480	600Y/347V	600
M	MJAE	100	35	35	18	18
H	HJAE	100	65	65	22	22
C	CJAE	200	100	100	35	35
L	LJAE	200	150	150	50	50
E	EJAE	—	200	200	100	100

Dimensions

Shipping Weight

Breaker	Poles	W in. (mm)	H in. (mm)	D in. (mm)	lbs.	kg
3VA63	3	5.4 (138)	9.7 (248)	4.3 (110)	9.9	4.5
3VA63	4	7.2 (184)	9.7 (248)	4.3 (110)	15.2	6.9

Molded Case Circuit Breakers

3VA63 400A Electronic Trip Circuit Breakers

Technical information

Trip Settings for 3VA63

ETU320-LI, ETU330-LIG, ETU350-LSI

Continuous Amperage	LI, LIG, LSI			LSI		LIG	LI, LIG, LSI 4P only
I_n (Amp)	I_n (Amp) (L)	t_{sd} (sec) (L)	I_n (Amp) (I)Ⓣ	$I_{sd}=xI_n$ (Amp) (S)	t_{sd} (sec) (S)	I_n (Amp) (G)	$I_n=xI_n$ (Amp)
250	100 - 250	0.5 - 17	375-3000	1.5 - 10	0.08 - 0.4	50 - 250	0.5 - 1 / OFF
400	150 - 400	0.5 - 17	600-4000	1.5 - 10		80 - 400	0.5 - 1 / OFF

Ⓣ I_n for ETU350 is fixed at 12X I_n

ETU550-LSI, ETU556 LSI(A), ETU560-LSIG, ETU820-LI, ETU830-LIG, ETU850-LSI, ETU856 LSI(A), ETU860-LSIG

Continuous Amperage	LI, LIG, LSI, LSIG, LSI(G)			LSI, LSIG, LSI(G)		LIG, LSIG, LSI(G)		LSI 3P with External CT	LI, LIG, LSI, LSIG, LSI(G) 4P only
I_n (Amp)	I_n (Amp) (L)	t_{sd} (sec) (L)	I_n (Amp) (I)	I_{sd} (Amp) (S)	t_{sd} (sec) (S)	I_n (Amp) (G)	t_n (G)	$I_n=xI_n$ (Amp)	I_n (Amp)
250	100 - 250	0.5 - 25	375-3000	150 - 2500	0.05 - 0.5	50 - 250	0.05 - 0.8	50 - 400 / OFF	50 - 400 / OFF
400	150 - 400	0.5 - 17	600-4000	240 - 4000		80 - 400		80 - 640 / OFF	80 - 400 / OFF

For specific trip settings refer to the Electronic Trip Unit section of the 3VA Systems Manual, which can be found in the document download center at https://www.siemens.com/download?BTLV_50412

Molded Case Circuit Breakers

3VA54 600A Thermal-magnetic Trip Circuit Breakers

Selection

3VA54 600A Frame, 2-(3)Pole Frame,
Thermal-Magnetic Trip Unit

Cont. Ampere Rating	M-Interrupting Class (MLAS)	H-Interrupting Class (HLAS)	C-Interrupting Class (CLAS)
	Catalog Number	Catalog Number	Catalog Number
TM230 FTAM			
450	—	3VA5445-6EC61-0AA0	3VA5445-7EC61-0AA0
500	3VA5450-5EC61-0AA0	3VA5450-6EC61-0AA0	3VA5450-7EC61-0AA0
600	3VA5460-5EC61-0AA0	3VA5460-6EC61-0AA0	3VA5460-7EC61-0AA0

3VA54 600A Frame, 3-Pole Frame,
Thermal-Magnetic Trip Unit

Cont. Ampere Rating	M-Interrupting Class (MLAS)	H-Interrupting Class (HLAS)	C-Interrupting Class (CLAS)
	Catalog Number	Catalog Number	Catalog Number
TM230 FTAM [Ⓞ]			
450	3VA5445-5EC31-0AA0	3VA5445-6EC31-0AA0	3VA5445-7EC31-0AA0
500	3VA5450-5EC31-0AA0	3VA5450-6EC31-0AA0	3VA5450-7EC31-0AA0
600	3VA5460-5EC31-0AA0	3VA5460-6EC31-0AA0	3VA5460-7EC31-0AA0
TM240 ATAM			
450	3VA5445-5EF31-0AA0	3VA5445-6EF31-0AA0	3VA5445-7EF31-0AA0
500	3VA5450-5EF31-0AA0	3VA5450-6EF31-0AA0	3VA5450-7EF31-0AA0
600	3VA5460-5EF31-0AA0	3VA5460-6EF31-0AA0	3VA5460-7EF31-0AA0



3VA54 600A 3-Pole



3VA54 600A 3-Pole

3VA54 600A Frame, 4-Pole Frame,
Thermal-Magnetic Trip Unit

Cont. Ampere Rating	M-Interrupting Class (MLAS)	H-Interrupting Class (HLAS)	C-Interrupting Class (CLAS)
	Catalog Number	Catalog Number	Catalog Number
TM230 FTAM Unprotected Neutral			
450	3VA5445-5EC41-0AA0	3VA5445-6EC41-0AA0	3VA5445-7EC41-0AA0
500	3VA5450-5EC41-0AA0	3VA5450-6EC41-0AA0	3VA5450-7EC41-0AA0
600	3VA5460-5EC41-0AA0	3VA5460-6EC41-0AA0	3VA5460-7EC41-0AA0
TM240 ATAM Unprotected Neutral			
450	3VA5445-5EF41-0AA0	3VA5445-6EF41-0AA0	3VA5445-7EF41-0AA0
500	3VA5450-5EF41-0AA0	3VA5450-6EF41-0AA0	3VA5450-7EF41-0AA0
600	3VA5460-5EF41-0AA0	3VA5460-6EF41-0AA0	3VA5460-7EF41-0AA0
TM230 FTFM 100% Neutral			
450	3VA5445-5GC41-0AA0	3VA5445-6GC41-0AA0	3VA5445-7GC41-0AA0
500	3VA5450-5GC41-0AA0	3VA5450-6GC41-0AA0	3VA5450-7GC41-0AA0
600	3VA5460-5GC41-0AA0	3VA5460-6GC41-0AA0	3VA5460-7GC41-0AA0
TM240 ATAM 100% Neutral			
450	3VA5445-5GF41-0AA0	3VA5445-6GF41-0AA0	3VA5445-7GF41-0AA0
500	3VA5450-5GF41-0AA0	3VA5450-6GF41-0AA0	3VA5450-7GF41-0AA0
600	3VA5460-5GF41-0AA0	3VA5460-6GF41-0AA0	3VA5460-7GF41-0AA0

Ordering Information

The catalog numbers listed here are for complete, non-interchangeable trip circuit breakers without lugs.

Order required lugs or connection technology separately for field installation.

All 3VA54 thermal-magnetic trip circuit breakers are CSA approved and UL listed for reverse feed applications.

For NAVAL rated thermal-magnetic trip circuit breakers, change the 13th digit of the catalog number to the number "1". (For example, a 18kA @600VAC, 600A, 3-pole, rated 3VA54 would be catalog number 3VA5460-5EC31-1AA0)

[Ⓞ] Available with NAVAL/50C ratings.

Molded Case Circuit Breakers

3VA54 600A Thermal-magnetic Trip Circuit Breakers

Selection

Dimensions

Shipping Weight

Breaker	Poles	W in. (mm)	H in. (mm)	D in. (mm)	lbs.	kg
3VA54	3	6.4 (162)	10.3 (262)	6.7 (170)	11.5	5.2
3VA54	4	8.2 (208)	10.3 (262)	6.7 (170)	15.0	6.8

Interrupting Ratings for 3VA54

Interrupting Class	Breaker Type	RMS Symmetrical Amperes (kA)									
		Volts AC (50/60 Hz)					Volts DC				
		240	480Y/ 277V	480	600Y/ 347V	600	250 (2P)	600 (3P)	750 (3P)	750 (4P)	1000 (4P)
M	MLAS	65	35	35	20	20	50	50	6	50	6
H	HLAS	100	65	65	25	25	85	85	6	85	6
C	CLAS	200	100	100	35	35	100	100	10	100	10

Internal accessories Optional equipment		3VA5 400/600 A 3 & 4-pole											
Slot No.:		25	24	23	22	21	600 A	11	12	13	14	15	
Auxiliary switch	Type												
Auxiliary switch	AUX_HQ	x	x	x	x	x		x	x	x	x	x	
	AUX_HQ_el	x	x	x	x	x		x	x	x	x	x	
	AUX_HP	x	x	x				x		x		x	
Leading changeover switch	LCS_HQ							x					
	LCS_HQ_el							x					
	LCS_HP							x					
Auxiliary switch	Type												
Trip alarm switch	TAS_HQ				x	x		x	x				
	TAS_HQ_el				x	x		x	x				
	TAS_HP				x			x					
Auxiliary switch	Type												
Shunt trip flexible	STF				x			x					
Shunt trip left	STL				x								
Undervoltage release	UVR				x								
Universal release	UVI				x								
Other													
Cylinder lock (type Ronis)											x		

Molded Case Circuit Breakers

3VA64 600A Thermal-magnetic Trip Circuit Breakers

Selection



3VA64 600A 3-Pole

Ordering Information

The catalog numbers listed below are for complete, non-interchangeable trip circuit breakers without lugs.

Order required lugs or connection technology separately for field installation.

All 3VA64 electronic trip circuit breakers are CSA approved and UL listed for reverse feed applications.

3VA64 electronic trip circuit breakers are available with 100% ratings (400A only).

For 100% rated electronic trip circuit breakers, change the 13th digit of the catalog number to the number "2". (For example, a 18kA @600VAC, 400A, 3-pole, 100% rated 3VA64 would be catalog number 3VA6440-5HL31-2AA0)

Requires the use of copper lugs — see lug table below.

All 3VA6 circuit breakers are certified to CSA C22.2 No 5, and UL 489 Supplement SB, are marked "Naval", and are suitable for use at 50C.

3VA64 600A Frame 3-Pole Electronic Trip Unit

Continuous Ampere	M-Interrupting Class (MLAE)	H-Interrupting Class (HLAE)	C-Interrupting Class (CLAE)	L-Interrupting Class (LLAE)	E-Interrupting Class (ELAE)
	Catalog Number	Catalog Number	Catalog Number	Catalog Number	Catalog Number
ETU320 LI with dials					
400	3VA6440-5HL31-0AA0	3VA6440-6HL31-0AA0	3VA6440-7HL31-0AA0	3VA6440-8HL31-0AA0	—
600	3VA6460-5HL31-0AA0	3VA6460-6HL31-0AA0	3VA6460-7HL31-0AA0	3VA6460-8HL31-0AA0	3VA6460-0HL31-0AA0
ETU330 LIG with dials					
400	3VA6440-5HM31-0AA0	3VA6440-6HM31-0AA0	3VA6440-7HM31-0AA0	3VA6440-8HM31-0AA0	—
600	3VA6460-5HM31-0AA0	3VA6460-6HM31-0AA0	3VA6460-7HM31-0AA0	3VA6460-8HM31-0AA0	3VA6460-0HM31-0AA0
ETU350 LSI with dials					
400	3VA6440-5HN31-0AA0	3VA6440-6HN31-0AA0	3VA6440-7HN31-0AA0	3VA6440-8HN31-0AA0	—
600	3VA6460-5HN31-0AA0	3VA6460-6HN31-0AA0	3VA6460-7HN31-0AA0	3VA6460-8HN31-0AA0	3VA6460-0HN31-0AA0
ETU550 LSI with LCD					
400	3VA6440-5JP31-0AA0	3VA6440-6JP31-0AA0	3VA6440-7JP31-0AA0	3VA6440-8JP31-0AA0	—
600	3VA6460-5JP31-0AA0	3VA6460-6JP31-0AA0	3VA6460-7JP31-0AA0	3VA6460-8JP31-0AA0	—
ETU556 LSI(G Alarm) with LCD					
400	3VA6440-5JT31-0AA0	3VA6440-6JT31-0AA0	3VA6440-7JT31-0AA0	3VA6440-8JT31-0AA0	—
600	3VA6460-5JT31-0AA0	3VA6460-6JT31-0AA0	3VA6460-7JT31-0AA0	3VA6460-8JT31-0AA0	—
ETU560 LSI(G) with LCD					
400	3VA6440-5JQ31-0AA0	3VA6440-6JQ31-0AA0	3VA6440-7JQ31-0AA0	3VA6440-8JQ31-0AA0	—
600	3VA6460-5JQ31-0AA0	3VA6460-6JQ31-0AA0	3VA6460-7JQ31-0AA0	3VA6460-8JQ31-0AA0	—
ETU820 LI with LCD and Metering					
400	3VA6440-5KL31-0AA0	3VA6440-6KL31-0AA0	3VA6440-7KL31-0AA0	3VA6440-8KL31-0AA0	—
600	3VA6460-5KL31-0AA0	3VA6460-6KL31-0AA0	3VA6460-7KL31-0AA0	3VA6460-8KL31-0AA0	—
ETU830 LIG with LCD and Metering					
400	3VA6440-5KM31-0AA0	3VA6440-6KM31-0AA0	3VA6440-7KM31-0AA0	3VA6440-8KM31-0AA0	—
600	3VA6460-5KM31-0AA0	3VA6460-6KM31-0AA0	3VA6460-7KM31-0AA0	3VA6460-8KM31-0AA0	—
ETU850 LSI with LCD and Metering					
400	3VA6440-5KP31-0AA0	3VA6440-6KP31-0AA0	3VA6440-7KP31-0AA0	3VA6440-8KP31-0AA0	—
600	3VA6460-5KP31-0AA0	3VA6460-6KP31-0AA0	3VA6460-7KP31-0AA0	3VA6460-8KP31-0AA0	—
ETU856 LSI(G Alarm) with LCD and Metering					
400	3VA6440-5KT31-0AA0	3VA6440-6KT31-0AA0	3VA6440-7KT31-0AA0	3VA6440-8KT31-0AA0	—
600	3VA6460-5KT31-0AA0	3VA6460-6KT31-0AA0	3VA6460-7KT31-0AA0	3VA6460-8KT31-0AA0	3VA6460-0KT31-0AA0
ETU860 LSI(G) with LCD and Metering					
400	3VA6440-5KQ31-0AA0	3VA6440-6KQ31-0AA0	3VA6440-7KQ31-0AA0	3VA6440-8KQ31-0AA0	—
600	3VA6460-5KQ31-0AA0	3VA6460-6KQ31-0AA0	3VA6460-7KQ31-0AA0	3VA6460-8KQ31-0AA0	3VA6460-0KQ31-0AA0

Molded Case Circuit Breakers

3VA64 600A Electronic Trip Circuit Breakers

Selection



3VA64 600A 4-Pole

Ordering Information

The catalog numbers listed below are for complete, non-interchangeable trip circuit breakers without lugs.

Order required lugs or connection technology separately for field installation.

All 3VA64 electronic trip circuit breakers are CSA approved and UL listed for reverse feed applications.

3VA64 electronic trip circuit breakers are available with 100% ratings (400A only).

For 100% rated electronic trip circuit breakers, change the 13th digit of the catalog number to the number "2". (For example, a 18kA @600VAC, 400A, 3-pole, 100% rated 3VA64 would be catalog number 3VA6440-5HL31-2AA0) Requires the use of copper lugs — see lug table below.

All 3VA6 circuit breakers are certified to CSA C22.2 No 5, and UL 489 Supplement SB, are marked "Naval", and are suitable for use at 50C.

3VA64 600A Frame 4-Pole Electronic Trip Unit

Continuous Ampere	M-Interrupting Class (MLAE)	H-Interrupting Class (HLAE)	C-Interrupting Class (CLAE)	L-Interrupting Class (LLAE)	E-Interrupting Class (ELAE)
	Catalog Number	Catalog Number	Catalog Number	Catalog Number	Catalog Number
ETU320 LI with dials					
400	3VA6440-5HL41-0AA0	3VA6440-6HL41-0AA0	3VA6440-7HL41-0AA0	3VA6440-8HL41-0AA0	—
600	3VA6460-5HL41-0AA0	3VA6460-6HL41-0AA0	3VA6460-7HL41-0AA0	3VA6460-8HL41-0AA0	3VA6460-0HL41-0AA0
ETU330 LIG with dials					
400	3VA6440-5HM41-0AA0	3VA6440-6HM41-0AA0	3VA6440-7HM41-0AA0	3VA6440-8HM41-0AA0	—
600	3VA6460-5HM41-0AA0	3VA6460-6HM41-0AA0	3VA6460-7HM41-0AA0	3VA6460-8HM41-0AA0	3VA6460-0HM41-0AA0
ETU350 LSI with dials					
400	3VA6440-5HN41-0AA0	3VA6440-6HN41-0AA0	3VA6440-7HN41-0AA0	3VA6440-8HN41-0AA0	—
600	3VA6460-5HN41-0AA0	3VA6460-6HN41-0AA0	3VA6460-7HN41-0AA0	3VA6460-8HN41-0AA0	3VA6460-0HN41-0AA0
ETU550 LSI with LCD					
400	3VA6440-5JP41-0AA0	3VA6440-6JP41-0AA0	3VA6440-7JP41-0AA0	3VA6440-8JP41-0AA0	—
600	3VA6460-5JP41-0AA0	3VA6460-6JP41-0AA0	3VA6460-7JP41-0AA0	3VA6460-8JP41-0AA0	—
ETU556 LSI(G Alarm) with LCD					
400	3VA6440-5JT41-0AA0	3VA6440-6JT41-0AA0	3VA6440-7JT41-0AA0	3VA6440-8JT41-0AA0	—
600	3VA6460-5JT41-0AA0	3VA6460-6JT41-0AA0	3VA6460-7JT41-0AA0	3VA6460-8JT41-0AA0	—
ETU560 LSI(G) with LCD					
400	3VA6440-5JQ41-0AA0	3VA6440-6JQ41-0AA0	3VA6440-7JQ41-0AA0	3VA6440-8JQ41-0AA0	—
600	3VA6460-5JQ41-0AA0	3VA6460-6JQ41-0AA0	3VA6460-7JQ41-0AA0	3VA6460-8JQ41-0AA0	—
ETU820 LI with LCD and Metering					
400	3VA6440-5KL41-0AA0	3VA6440-6KL41-0AA0	3VA6440-7KL41-0AA0	3VA6440-8KL41-0AA0	—
600	3VA6460-5KL41-0AA0	3VA6460-6KL41-0AA0	3VA6460-7KL41-0AA0	3VA6460-8KL41-0AA0	—
ETU830 LIG with LCD and Metering					
400	3VA6440-5KM41-0AA0	3VA6440-6KM41-0AA0	3VA6440-7KM41-0AA0	3VA6440-8KM41-0AA0	—
600	3VA6460-5KM41-0AA0	3VA6460-6KM41-0AA0	3VA6460-7KM41-0AA0	3VA6460-8KM41-0AA0	—
ETU850 LSI with LCD and Metering					
400	3VA6440-5KP41-0AA0	3VA6440-6KP41-0AA0	3VA6440-7KP41-0AA0	3VA6440-8KP41-0AA0	—
600	3VA6460-5KP41-0AA0	3VA6460-6KP41-0AA0	3VA6460-7KP41-0AA0	3VA6460-8KP41-0AA0	—
ETU856 LSI(G Alarm) with LCD and Metering					
400	3VA6440-5KT41-0AA0	3VA6440-6KT41-0AA0	3VA6440-7KT41-0AA0	3VA6440-8KT41-0AA0	—
600	3VA6460-5KT41-0AA0	3VA6460-6KT41-0AA0	3VA6460-7KT41-0AA0	3VA6460-8KT41-0AA0	3VA6460-0KT41-0AA0
ETU860 LSI(G) with LCD and Metering					
400	3VA6440-5KQ41-0AA0	3VA6440-6KQ41-0AA0	3VA6440-7KQ41-0AA0	3VA6440-8KQ41-0AA0	—
600	3VA6460-5KQ41-0AA0	3VA6460-6KQ41-0AA0	3VA6460-7KQ41-0AA0	3VA6460-8KQ41-0AA0	3VA6460-0KQ41-0AA0

Molded Case Circuit Breakers

3VA64 600A Electronic Trip Circuit Breakers

Technical information

Connectors for 75C wire for 3VA64

Type	Minimum cable size	Maximum cable size	Part Number (kit of 3 lugs)	Part Number (kit of 4 lugs)
Steel Wrap around (Cu cable only) single cable lugs	1/0	500 kcmil	3VA9473-0JA13	3VA9474-0JA13
Aluminum Body Lug (Cu/Al cable) single cable lugs	AWG 1	600 kcmil	3VA9373-0JB13	3VA9374-0JB13
Aluminum body lug with control wire tap (Cu/Al cable) single cable lugs	AWG 1	600 kcmil	3VA9373-0JG13	3VA9374-0JG13
Aluminum body lug, 2 cables (Cu/Al cable) with 1 extended terminal cover	2/0	600 kcmil	3VA9473-0JJ23	3VA9474-0JJ23
Aluminum body lug, 2 cables (Cu/Al cable) with control wire tap and 1 extended terminal cover	2/0	600 kcmil	3VA9473-0JC23	3VA9474-0JC23
Distribution lug, 6 Cables (Cu/Al cable) with 1 extended terminal cover	AWG 14	AWG 2	3VA9373-0JF60	3VA9374-0JF60
Copper body lug (Cu cable only) single cable lugs (meets requirements for 100% rated breakers)	AWG 1	600 kcmil	3VA9373-0JD13	3VA9374-0JD13
Copper body lug (Cu cable only) with control wire tap single cable lugs	AWG 1	600 kcmil	3VA9373-0JK13	3VA9374-0JK13
Copper body lug, 2 cables (Cu cable only) with 1 extended terminal cover (meets requirements for 100% rated breakers)	2/0	600 kcmil	3VA9473-0JE23	3VA9474-0JE23
Copper body lug, 2 cables (Cu cable only) with control wire tap and 1 extended terminal cover	2/0	600 kcmil	3VA9473-0JL23	3VA9474-0JL23

Interrupting Ratings for 3VA64

Interrupting Class	Breaker Type	RMS Symmetrical Amperes (kA)				
		Volts AC (50/60 Hz)				
		240	480Y/277V	480	600Y/347V	600
M	MLAE	100	35	35	18	18
H	HLAE	100	65	65	22	22
C	CLAE	200	100	100	35	35
L	LLAE	200	150	150	50	50
E	ELAE	—	200	200	100	100

Dimensions

Shipping Weight

Breaker	Poles	W in. (mm)	H in. (mm)	D in. (mm)	lbs.	kg
3VA64	3	5.4 (138)	9.7 (248)	4.3 (110)	11.7	5.3
3VA64	4	7.2 (184)	9.7 (248)	4.3 (110)	15.2	6.9

Molded Case Circuit Breakers

3VA64 600A Electronic Trip Circuit Breakers

Technical information

Trip Settings for 3VA64

ETU320-LI, ETU330-LIG, ETU350-LSI

Continuous Amperage	LI, LIG, LSI			LSI		LIG	LI, LIG, LSI 4P only
I_n (Amp)	I_n (Amp) (L)	t_{tr} (sec) (L)	I_n (Amp) (I)①	$I_{tr} = xI_n$ (Amp) (S)	t_{tr} (sec) (S)	I_n (Amp) (G)	$I_n = xI_n$ (Amp)
400	150 - 400	0.5 - 17	600-4800	1.5 - 10	0.08 - 0.4	80 - 400	0.5 - 1 / OFF
600	250 - 600	0.5 - 15	900-5400	1.5 - 9		120 - 600	0.5 - 1 / OFF

① I_n for ETU350 is fixed at 12X I_n .

ETU550-LSI, ETU556 LSI(A), ETU560-LSIG, ETU820-LI, ETU830-LIG, ETU850-LSI, ETU856 LSI(A), ETU860-LSIG

Continuous Amperage	LI, LIG, LSI, LSIG, LSI(G)			LSI, LSIG, LSI(G)		LIG, LSIG, LSI(G)		LSI 3P with External CT	LI, LIG, LSI, LSIG, LSI(G) 4P only
I_n (Amp)	I_n (Amp) (L)	t_{tr} (sec) (L)	I_n (Amp) (I)	I_n (Amp) (S)	t_{tr} (sec) (S)	I_n (Amp) (G)	t_{tr} (G)	$I_n = xI_n$ (Amp)	I_n (Amp)
400	150 - 400	0.5 - 25	600-4800	240 - 4000	0.05 - 0.5	80 - 400	0.05 - 0.8	80 - 640 / OFF	80 - 600 / OFF
600	250 - 600	0.5 - 15	900-5400	360 - 5400		120 - 600		120 - 960 / OFF	120 - 600 / OFF

For specific trip settings refer to the Electronic Trip Unit section of the 3VA Systems Manual, which can be found in the document download center at https://www.siemens.com/download?BTLV_50412

Internal accessories Optional equipment	3VA6 400/600 A 3-pole											3VA6 400/600 A 4-pole															
	Slot No.:	25	24	23	22	21	600 A	11	12	13	14	15	35	34	33	32	31	25	24	23	22	21	600 A	11	12	13	14
Auxiliary switch	Type																										
Auxiliary switch	AUX_HQ	x	x	x	x	x		x	x	x	x	x	x	x	x	x	x	x	x	x	x		x	x	x	x	x
	AUX_HQ_el	x	x	x	x	x		x	x	x	x	x	x	x	x	x	x	x	x	x	x		x	x	x	x	x
	AUX_HP				x	x			x	x	x					x	x	x						x	x	x	
Leading changeover switch	LCS_HQ																										
	LCS_HQ_el																										
	LCS_HP																										
Auxiliary switch	Type																										
Trip alarm switch	TAS_HQ				x	x			x	x																	
	TAS_HQ_el				x	x			x	x																	
	TAS_HP					x				x																	
Electrical alarm switch	EAS_HQ																										
	EAS_HQ_el																										
Auxiliary switch	Type																										
Shunt trip flexible	STF				x					x																	
Shunt trip left	STL				x																						
Undervoltage release	UVR				x																						
Universal release	UVI				x																						
ETU/communication	Type																										
Communication module	COM060																										
Breaker data server																											
24 V module																											
Other																											
Cylinder lock (type Ronis)																											

See page 5-72 for internal accessory part numbers.

Molded Case Circuit Breakers

3VA55 800A Electronic Trip Circuit Breakers

Selection

3VA55 800A, 2-pole in 3-pole Frame, Thermal-Magnetic Trip Unit

Cont. Ampere Rating	M-Interrupting Class (MMAS)	H-Interrupting Class (HMAS)	C-Interrupting Class (CMAS)
	Catalog Number	Catalog Number	Catalog Number
TM230 FTAM			
600	3VA5560-5EC62-0AA0	3VA5560-6EC62-0AA0	3VA5560-7EC62-0AA0
700	3VA5570-5EC62-0AA0	3VA5570-6EC62-0AA0	3VA5570-7EC62-0AA0
800	3VA5580-5EC62-0AA0	3VA5580-6EC62-0AA0	3VA5580-7EC62-0AA0

3VA55 800A, 3-pole Frame, Thermal-Magnetic Trip Unit

Cont. Ampere Rating	M-Interrupting Class (MMAS)	H-Interrupting Class (HMAS)	C-Interrupting Class (CMAS)
	Catalog Number	Catalog Number	Catalog Number
TM230 FTAM			
600	3VA5560-5EC32-0AA0	3VA5560-6EC32-0AA0	3VA5560-7EC32-0AA0
700	3VA5570-5EC32-0AA0	3VA5570-6EC32-0AA0	3VA5570-7EC32-0AA0
800	3VA5580-5EC32-0AA0	3VA5580-6EC32-0AA0	3VA5580-7EC32-0AA0

3VA55 800A, 4-pole Frame, Thermal-Magnetic Trip Unit

Cont. Ampere Rating	M-Interrupting Class (MMAS)	H-Interrupting Class (HMAS)	C-Interrupting Class (CMAS)
	Catalog Number	Catalog Number	Catalog Number
TM230 FTAM Unprotected Neutral			
600	3VA5560-5EC42-0AA0	3VA5560-6EC42-0AA0	3VA5560-7EC42-0AA0
700	3VA5570-5EC42-0AA0	3VA5570-6EC42-0AA0	3VA5570-7EC42-0AA0
800	3VA5580-5EC42-0AA0	3VA5580-6EC42-0AA0	3VA5580-7EC42-0AA0
TM230 FTAM 100% Neutral			
600	3VA5560-5GC42-0AA0	3VA5560-6GC42-0AA0	3VA5560-7GC42-0AA0
700	3VA5570-5GC42-0AA0	3VA5570-6GC42-0AA0	3VA5570-7GC42-0AA0
800	3VA5580-5GC42-0AA0	3VA5580-6GC42-0AA0	3VA5580-7GC42-0AA0

Dimensions

Shipping Weight

Breaker	Poles	W in. (mm)	H in. (mm)	D in. (mm)	lbs.	kg
3VA55	2(3)	8.3 (210)	12.5 (318)	5.8 (147)	29.3	13.3
3VA55	3	8.3 (210)	12.5 (318)	5.8 (147)	29.4	13.4
3VA55	4	11.1 (280)	12.5 (318)	5.8 (147)	37.4	17.0

Interrupting Ratings for 3VA55

Interrupting Class	Breaker Type	RMS Symmetrical Amperes (kA)									
		Volts AC (50/60 Hz)					Volts DC				
		240	480Y/277V	480	600Y/347V	600	250 (2P)	600 (3P)	750 (3P)	750 (4P)	1000 (4P)
M	MMAS	85	35	35	18	18	50	50	50	50	18
H	HMAS	100	65	65	25	25	85	85	85	85	25
C	CMAS	200	100	100	50	50	100	100	100	100	50

Trip Settings for 3VA55

TM230 - FTAM

I _n (Amp)	I ₁ (Amp)	I ₂ (Amp)	I ₃ (Amp)	I ₄ (Amp)	I ₅ (Amp)	I ₆ (Amp)	I ₇ (Amp)
600	600	3000	3600	4200	4800	5400	6000
700	700	3500	4200	4900	5600	6300	7000
800	800	4000	4800	5600	6400	7200	8000

TM240 - ATAM

I _n (Amp)	I ₁ (Amp)	I ₂ (Amp)	I ₃ (Amp)	I ₄ (Amp)	I ₅ (Amp)	I ₆ (Amp)	I ₇ (Amp)
600	480	3000	3600	4200	4800	5400	6000
700	560	3500	4200	4900	5600	6300	7000
800	640	4000	4800	5600	6400	7200	8000



Ordering Information

The catalog numbers listed here are for complete, non-interchangeable trip circuit breakers with nut keepers on both line and load ends.

Order required lugs or connection technology separately for field installation.

All 3VA55 thermal-magnetic trip circuit breakers are UL listed for reverse feed applications.

For NAVAL rated (3-pole only) thermal-magnetic trip circuit breakers, change the 13th digit of the catalog number to the number "1". (For example, a 18KA@600V, 600A, 3-pole, rated 3VA55 would be catalog number 3VA5580-5EC32-1AA0)

Molded Case Circuit Breakers

3VA65 800A Electronic Trip Circuit Breakers

Selection



3VA65 800A 3-Pole

Ordering Information

The catalog numbers listed below are for complete, non-interchangeable trip circuit breakers with nut keepers on both line and load ends.

Order required lugs or connection technology separately for field installation.

All 3VA65 electronic trip circuit breakers are UL listed for reverse feed applications.

3VA65 electronic trip circuit breakers are available with 100% ratings.

For 100% rated electronic trip circuit breakers, change the 13th digit of the catalog number to the number "2". (For example, a 25KA@600V, 600A, 3-pole, 100% rated 3VA65 would be catalog number 3VA6560-5HL32-2AA0)

All 3VA6 circuit breakers are certified to UL 489 Supplement SB, are marked "Naval", and are suitable for use at 50C.

3VA65 800A, 3-pole Frame, Electronic Trip Unit

Continuous Ampere	M-Interrupting Class (MMAE)	H-Interrupting Class (HMAE)	C-Interrupting Class (CMAE)
	Catalog Number	Catalog Number	Catalog Number
ETU320 LI with dials			
600	3VA6560-5HL32-0AA0	3VA6560-6HL32-0AA0	3VA6560-7HL32-0AA0
800	3VA6580-5HL32-0AA0	3VA6580-6HL32-0AA0	3VA6580-7HL32-0AA0
ETU330 LIG with dials			
600	3VA6560-5HM32-0AA0	3VA6560-6HM32-0AA0	3VA6560-7HM32-0AA0
800	3VA6580-5HM32-0AA0	3VA6580-6HM32-0AA0	3VA6580-7HM32-0AA0
ETU350 LSI with dials			
600	3VA6560-5HN32-0AA0	3VA6560-6HN32-0AA0	3VA6560-7HN32-0AA0
800	3VA6580-5HN32-0AA0	3VA6580-6HN32-0AA0	3VA6580-7HN32-0AA0
ETU550 LSI with LCD			
600	3VA6560-5JP32-0AA0	3VA6560-6JP32-0AA0	3VA6560-7JP32-0AA0
800	3VA6580-5JP32-0AA0	3VA6580-6JP32-0AA0	3VA6580-7JP32-0AA0
ETU556 LSI(G Alarm) with LCD			
600	3VA6560-5JT32-0AA0	3VA6560-6JT32-0AA0	3VA6560-7JT32-0AA0
800	3VA6580-5JT32-0AA0	3VA6580-6JT32-0AA0	3VA6580-7JT32-0AA0
ETU560 LSI(G) with LCD			
600	3VA6560-5JQ32-0AA0	3VA6560-6JQ32-0AA0	3VA6560-7JQ32-0AA0
800	3VA6580-5JQ32-0AA0	3VA6580-6JQ32-0AA0	3VA6580-7JQ32-0AA0
ETU820 LI with LCD and Metering			
600	3VA6560-5KL32-0AA0	3VA6560-6KL32-0AA0	3VA6560-7KL32-0AA0
800	3VA6580-5KL32-0AA0	3VA6580-6KL32-0AA0	3VA6580-7KL32-0AA0
ETU856 LSI(G Alarm) with LCD and Metering			
600	3VA6560-5KT32-0AA0	3VA6560-6KT32-0AA0	3VA6560-7KT32-0AA0
800	3VA6580-5KT32-0AA0	3VA6580-6KT32-0AA0	3VA6580-7KT32-0AA0
ETU860 LSI(G) with LCD and Metering			
600	3VA6560-5KQ32-0AA0	3VA6560-6KQ32-0AA0	3VA6560-7KQ32-0AA0
800	3VA6580-5KQ32-0AA0	3VA6580-6KQ32-0AA0	3VA6580-7KQ32-0AA0

Molded Case Circuit Breakers

3VA65 800A Electronic Trip Circuit Breakers

Selection



3VA65 800A 4-Pole

Interrupting Ratings for 3VA65

Interrupting Class	Breaker Type	RMS Symmetrical Amperes (kA)				
		Volts AC (50/60 Hz)				
		240	480Y/277V	480	600Y/347V	600
M	MMAE	100	35	35	25	25
H	HMAE	150	65	65	35	35
C	CMAE	200	100	100	50	50

Dimensions

Breaker	Poles	W in. (mm)	H in. (mm)	D in. (mm)	lbs.	kg
3VA65	3	8.3 (210)	12.5 (318)	5.8 (147)	29.4	13.4
3VA65	4	11.1 (280)	12.5 (318)	5.8 (147)	37.4	17.0

Shipping Weight

3VA65 800A, 4-pole Frame, Electronic Trip Unit

Continuous Ampere	M-Interrupting Class (MMAE)	H-Interrupting Class (HMAE)	C-Interrupting Class (CMAE)
	Catalog Number	Catalog Number	Catalog Number
ETU320 LI with dials			
600	3VA6560-5HL42-0AA0	3VA6560-6HL42-0AA0	3VA6560-7HL42-0AA0
800	3VA6580-5HL42-0AA0	3VA6580-6HL42-0AA0	3VA6580-7HL42-0AA0
ETU330 LIG with dials			
600	3VA6560-5HM42-0AA0	3VA6560-6HM42-0AA0	3VA6560-7HM42-0AA0
800	3VA6580-5HM42-0AA0	3VA6580-6HM42-0AA0	3VA6580-7HM42-0AA0
ETU350 LSI with dials			
600	3VA6560-5HN42-0AA0	3VA6560-6HN42-0AA0	3VA6560-7HN42-0AA0
800	3VA6580-5HN42-0AA0	3VA6580-6HN42-0AA0	3VA6580-7HN42-0AA0
ETU550 LSI with LCD			
600	3VA6560-5JP42-0AA0	3VA6560-6JP42-0AA0	3VA6560-7JP42-0AA0
800	3VA6580-5JP42-0AA0	3VA6580-6JP42-0AA0	3VA6580-7JP42-0AA0
ETU556 LSI(G Alarm) with LCD			
600	3VA6560-5JT42-0AA0	3VA6560-6JT42-0AA0	3VA6560-7JT42-0AA0
800	3VA6580-5JT42-0AA0	3VA6580-6JT42-0AA0	3VA6580-7JT42-0AA0
ETU560 LSI(G Alarm) with LCD			
600	3VA6560-5JQ42-0AA0	3VA6560-6JQ42-0AA0	3VA6560-7JQ42-0AA0
800	3VA6580-5JQ42-0AA0	3VA6580-6JQ42-0AA0	3VA6580-7JQ42-0AA0
ETU820 LI with LCD and Metering			
600	3VA6560-5KL42-0AA0	3VA6560-6KL42-0AA0	3VA6560-7KL42-0AA0
800	3VA6580-5KL42-0AA0	3VA6580-6KL42-0AA0	3VA6580-7KL42-0AA0
ETU856 LSI(G Alarm) with LCD and Metering			
600	3VA6560-5KT42-0AA0	3VA6560-6KT42-0AA0	3VA6560-7KT42-0AA0
800	3VA6580-5KT42-0AA0	3VA6580-6KT42-0AA0	3VA6580-7KT42-0AA0
ETU860 LSI(G Alarm) with LCD and Metering			
600	3VA6560-5KQ42-0AA0	3VA6560-6KQ42-0AA0	3VA6560-7KQ42-0AA0
800	3VA6580-5KQ42-0AA0	3VA6580-6KQ42-0AA0	3VA6580-7KQ42-0AA0

Molded Case Circuit Breakers

3VA55 and 3VA65 800A / 3VA66 1000A Electronic Trip Circuit Breakers

Selection

Connections for 75C wire for 3VA55, 3VA65 and 3VA66

Type	Minimum cable size	Maximum cable size	Part Number (kit of 3 lugs)	Part Number (kit of 4 lugs)
Aluminum body lug, 2 cables (Cu/Al cable)	4/0	600 kcmil	3VA9573-0JB23	3VA9574-0JB23
Aluminum body lug, 2 cables (Cu/Al cable) with control wire tap	4/0	600 kcmil	3VA9573-0JG23	3VA9574-0JG23
Aluminum body lug, 2 cables (Cu/Al cable) with 1 extended terminal cover ^①	400 kcmil	750 kcmil	3VA9673-0JJ24	3VA9674-0JJ24
Aluminum body lug, 2 cables (Cu/Al cable) with control wire tap and 1 extended terminal cover ^①	400 kcmil	750 kcmil	3VA9673-0JC24	3VA9674-0JC24
Aluminum body lug, 3 cables (Cu/Al cable)	4/0	400 kcmil	3VA9673-0JB32	3VA9674-0JB32
Aluminum body lug, 3 cables (Cu/Al cable) with control wire tap	4/0	400 kcmil	3VA9673-0JG32	3VA9674-0JG32
Aluminum body lug, 3 cables (Cu/Al cable) with 1 extended terminal cover ^①	500 kcmil	750 kcmil	3VA9673-0JJ34	3VA9674-0JJ34
Aluminum body lug, 3 cables (Cu/Al cable) with control wire tap and 1 extended terminal cover ^①	500 kcmil	750 kcmil	3VA9673-0JC34	3VA9674-0JC34
Aluminum body lug, 4 cables (Cu/Al cable) with 1 extended terminal cover ^①	4/0	500 kcmil	3VA9673-0JJ43	3VA9674-0JJ43
Aluminum body lug, 4 cables (Cu/Al cable) with control wire tap and 1 extended terminal cover ^①	4/0	500 kcmil	3VA9673-0JC43	3VA9674-0JC43
Aluminum body lug, 4 cables (Cu/Al cable) with 1 extended terminal cover ^①	4/0	600 kcmil	3VA9673-0JJ44	3VA9674-0JJ44
Aluminum body lug, 4 cables (Cu/Al cable) with control wire tap and 1 extended terminal cover ^①	4/0	600 kcmil	3VA9673-0JC44	3VA9674-0JC44
Copper body lug, 3 cables (Cu/Al cable) ^①	4/0	400 kcmil	3VA9673-0JD32	3VA9674-0JD32
Copper body lug, 3 cables (Cu/Al cable) with control wire tap ^①	4/0	400 kcmil	3VA9673-0JK32	3VA9674-0JK32
Copper body lug, 4 cables (Cu/Al cable) with 1 extended terminal cover	4/0	500 kcmil	3VA9673-0JE43	3VA9674-0JE43
Copper body lug, 4 cables (Cu/Al cable) with control wire tap and 1 extended terminal cover	4/0	500 kcmil	3VA9673-0JL43	3VA9674-0JL43

^① Meets requirements for 100% rated breakers up to 800A, requires the use of 90 degree wire.

■ Product not yet released.

Trip Settings for 3VA55

TM230 - FTAM

I _n (Amp)	I _l (Amp)	I _l (Amp)						
600	600	3000	3600	4200	4800	5400	6000	
700	700	3500	4200	4900	5600	6300	7000	
800	800	4000	4800	5600	6400	7200	8000	

Trip Settings for 3VA65 and 3VA66

ETU320-LI, ETU330-LIG, ETU350-LSI

Cont. Amp	LI, LIG, LSI				LSI		LIG	LI, LIG, LSI 4P only
I _n (Amp)	I _l (Amp) (L)	t _{ca} (sec) (L)	I _l (Amp) (I)	I _{ca} = xlr (Amp) (S)	t _{ca} (sec) (S)	I _l (Amp) (G)	I _{ca} =xI _n (Amp)	
600	240 - 600	0.5 - 17	900 - 7200	1.5 - 12	0 - 0.4	120 - 600	0.2 - 1.0	
800	320 - 800	0.5 - 17	1200 - 8000	1.5 - 10	0 - 0.4	160 - 800	0.2 - 1.0	
1000	400 - 1000	0.5 - 17	1500 - 10000	1.5 - 10	0 - 0.4	200 - 1000	0.2 - 1.0	

ETU550-LSI, ETU556 LSI(A), ETU560-LSIG, ETU820-LI, ETU856 LSI(A), ETU860-LSIG

Cont. Amp	LI, LIG, LSI, LSIG, LSI(G)				LSI, LSIG, LSI(G)		LIG, LSIG, LSI(G)		LSI 3P with External CT	LI, LIG, LSI, LSIG, LSI(G) 4P only
I _n (Amp)	I _l (Amp) (L)	t _{ca} (sec) (L)	I _l (Amp) (I)	I _{ca} (Amp) (S)	t _{ca} (sec) (S)	I _l (Amp) (G)	t _{ca} (G)	I _{ca} =xI _n (Amp)	I _l (Amp)	
600	240 - 600	0.5 - 25	900 - 7200	360 - 7200	0.05 - 0.5	120 - 600	0.05 - 0.8	120 - 960	120 - 600	
800	320 - 800	0.5 - 25	1200 - 8000	480 - 8000	0.05 - 0.5	160 - 800	0.05 - 0.8	160 - 1280	160 - 800	
1000	400 - 1000	0.5 - 25	1500 - 10000	600 - 10000	0.05 - 0.5	200 - 1000	0.05 - 0.8	200 - 1600	200 - 1000	

For specific trip settings refer to the Electronic Trip Unit section of the 3VA Systems Manual,

which can be found in the document download center at https://www.siemens.com/download?BTLV_50412

Internal accessories	Optional equipment	Slot No.:
Auxiliary switch	AUX_HQ	
Auxiliary switch	AUX_HQ_el	
Auxiliary switch	AUX_HP	
Leading changeover switch	LCS_HQ	
Alarm switch	TAS_HQ	
Trip alarm switch	TAS_HQ_el	
Electrical alarm switch (3VA6)	EAS_HQ	
Electrical alarm switch	SAS_HQ	
Auxiliary release	STF	
Shunt trip flexible	STL	
Residual current release	RCR	
Undervoltage release	UVR	
Universal release	UNI	
ETU/communication [®]	COM060	
Other	Cylinder lock (type Ronis)	

Molded Case Circuit Breakers

3VA66 1000A Electronic Trip Circuit Breakers

Selection



3VA66 800A 3-Pole

Ordering Information

The catalog numbers listed below are for complete, non-interchangeable trip circuit breakers with nut keepers on both line and load ends.

Order required lugs or connection technology separately for field installation.

All 3VA66 electronic trip circuit breakers are CSA approved / UL listed for reverse feed applications.

All 3VA66 circuit breakers are certified to UL 489 Supplement SB, are marked "Naval", and are suitable for use at 50C.

3VA66 1000A, 3-pole Frame, Electronic Trip Unit

Continuous Ampere	M-Interrupting Class (MMNAE)	H-Interrupting Class (HMNAE)	C-Interrupting Class (CMNAE)
	Catalog Number	Catalog Number	Catalog Number
	ETU320 LI with dials		
1000	3VA6610-5HL32-0AA0	3VA6610-6HL32-0AA0	3VA6610-7HL32-0AA0
	ETU330 LIG with dials		
1000	3VA6610-5HM32-0AA0	3VA6610-6HM32-0AA0	3VA6610-7HM32-0AA0
	ETU350 LSI with dials		
1000	3VA6610-5HN32-0AA0	3VA6610-6HN32-0AA0	3VA6610-7HN32-0AA0
	ETU550 LSI with LCD		
1000	3VA6610-5JP32-0AA0	3VA6610-6JP32-0AA0	3VA6610-7JP32-0AA0
	ETU556 LSI(G Alarm) with LCD		
1000	3VA6610-5JT32-0AA0	3VA6610-6JT32-0AA0	3VA6610-7JT32-0AA0
	ETU560 LSI(G) with LCD		
1000	3VA6610-5JQ32-0AA0	3VA6610-6JQ32-0AA0	3VA6610-7JQ32-0AA0
	ETU820 LI with LCD and Metering		
1000	3VA6610-5KL32-0AA0	3VA6610-6KL32-0AA0	3VA6610-7KL32-0AA0
	ETU856 LSI(G Alarm) with LCD and Metering		
1000	3VA6610-5KT32-0AA0	3VA6610-6KT32-0AA0	3VA6610-7KT32-0AA0
	ETU860 LSI(G) with LCD and Metering		
1000	3VA6610-5KQ32-0AA0	3VA6610-6KQ32-0AA0	3VA6610-7KQ32-0AA0

Molded Case Circuit Breakers

3VA66 1000A Electronic Trip Circuit Breakers

Selection



3VA66 800A 4-Pole

Interrupting Ratings for 3VA66

Interrupting Class	Breaker Type	RMS Symmetrical Amperes (kA)				
		Volts AC (50/60 Hz)				
		240	480Y/277V	480	600Y/347V	600
M	MMNAE	100	35	35	25	25
H	HMNAE	150	65	65	35	35
C	CMNAE	200	100	100	50	50

Dimensions

Shipping Weight

Breaker	Poles	W in. (mm)	H in. (mm)	D in. (mm)	lbs.	kg
3VA66	3	8.3 (210)	12.5 (318)	5.8 (147)	29.4	13.4
3VA66	4	11.1 (280)	12.5 (318)	5.8 (147)	37.4	17.0

3VA66 1000A, 4-pole Frame, Electronic Trip Unit

Continuous Ampere	M-Interrupting Class (MMNAE)	H-Interrupting Class (HMNAE)	C-Interrupting Class (CMNAE)
	Catalog Number	Catalog Number	Catalog Number
	ETU320 LI with dials		
1000	3VA6610-5HL42-0AA0	3VA6610-6HL42-0AA0	3VA6610-7HL42-0AA0
	ETU330 LIG with dials		
1000	3VA6610-5HM42-0AA0	3VA6610-6HM42-0AA0	3VA6610-7HM42-0AA0
	ETU350 LSI with dials		
1000	3VA6610-5HN42-0AA0	3VA6610-6HN42-0AA0	3VA6610-7HN42-0AA0
	ETU550 LSI with LCD		
1000	3VA6610-5JP42-0AA0	3VA6610-6JP42-0AA0	3VA6610-7JP42-0AA0
	ETU556 LSI(G Alarm) with LCD		
1000	3VA6610-5JT42-0AA0	3VA6610-6JT42-0AA0	3VA6610-7JT42-0AA0
	ETU560 LSIG with LCD		
1000	3VA6610-5JQ42-0AA0	3VA6610-6JQ42-0AA0	3VA6610-7JQ42-0AA0
	ETU820 LI with LCD and Metering		
1000	3VA6610-5KL42-0AA0	3VA6610-6KL42-0AA0	3VA6610-7KL42-0AA0
	ETU856 LSI(G Alarm) with LCD and Metering		
1000	3VA6610-5KT42-0AA0	3VA6610-6KT42-0AA0	3VA6610-7KT42-0AA0
	ETU860 LSIG with LCD and Metering		
1000	3VA6610-5KQ42-0AA0	3VA6610-6KQ42-0AA0	3VA6610-7KQ42-0AA0

Molded Case Circuit Breakers

3VA Molded Case Switch and Motor Circuit Protector

Selection

Breaking capacity (the SCCR rating) is the maximum permissible short circuit current at the installation location of the MCS in combination with an appropriate overload protective device.

Molded Case Switch Magnetic

Frame (Breaker Type)	Max. Ampere Rating	2-Pole	3-Pole	Short-Circuit Current Rating			Instantaneous short circuit protection
		Catalog Number	Catalog Number	240V	480V	600V	
3VA51 (HEAS)	100	3VA5110-1BB21-0AA0	3VA5110-1BB31-0AA0	100k	65k	14k [Ⓞ]	1600 A
3VA52 (HFAS)	150	3VA5215-0BB61-0AA0	3VA5215-0BB31-0AA0	100k	65k	25k	2400 A
	250	3VA5225-0BB61-0AA0	3VA5225-0BB31-0AA0	100k	65k	25k	2500 A
3VA53 (HJAS)	400	3VA5340-0BB61-0AA0	3VA5340-0BB31-0AA0	100k	65k	25k	6000 A
3VA54 (HLAS)	600	3VA5460-0BB61-0AA0	3VA5460-0BB31-0AA0	100k	65k	25k	6000 A
3VA55 (HMAS)	800	3VA5580-0BB61-0AA0	3VA5580-0BB31-0AA0	100k	65k	25k	8000 A



Magnetic switch

3VA52 (CFAS)	100	3VA5210-1BB61-0AA0	3VA5210-1BB31-0AA0	200k	100k	35k	2500 A
	150	3VA5215-1BB61-0AA0	3VA5215-1BB31-0AA0	200k	100k	35k	2400 A
	250	3VA5225-1BB61-0AA0	3VA5225-1BB31-0AA0	200k	100k	35k	2500 A
3VA53 (CJAS)	400	3VA5340-1BB61-0AA0	3VA5340-1BB31-0AA0	200k	100k	35k	6000 A
3VA54 (CLAS)	600	3VA5460-1BB61-0AA0	3VA5460-1BB31-0AA0	200k	100k	35k	6000 A
3VA55 (CMAS)	800	3VA5580-1BB61-0AA0	3VA5580-1BB31-0AA0	100k	100k	50k	8000 A



Electronic Trip Unit switch

Molded Case Switch Electronic

Frame (Breaker Type)	Max. Ampere Rating	2-Pole	3-Pole	Short-Circuit Current Rating			Instantaneous short circuit protection
		Catalog Number	Catalog Number	240V	480V	600V	
3VA63 (CJAE)	400	—	3VA6340-1BB31-0AA0	200k	100k	35k	5600 A
3VA64 (CLAE)	600	—	3VA6460-1BB31-0AA0	200k	100k	35k	5400 A

[Ⓞ] Rated at 600 Y/347 V AC.

Molded Case Circuit Breakers

3VA Molded Case Switch and Motor Circuit Protector

Selection

Motor circuit protector TM120M AM^{®3}

Frame (Breaker Type)	Maximum Ampere Rating	3-Pole Catalog Number	Instantaneous short circuit protection
3VA51 (HEAP)	1	3VA5181-1MU31-0AA0	3 ... 7
		3VA5181-1MH31-0AA0	5 ... 12
	2	3VA5102-1MU31-0AA0	6 ... 14
		3VA5102-1MH31-0AA0	10 ... 24
	3	3VA5103-1MU31-0AA0	9 ... 21
		3VA5103-1MH31-0AA0	15 ... 36
	5	3VA5105-1MU31-0AA0	15 ... 35
		3VA5105-1MH31-0AA0	25 ... 60
	7	3VA5107-1MU31-0AA0	21 ... 49
		3VA5107-1MH31-0AA0	35 ... 84
	10	3VA5191-1MU31-0AA0	30 ... 70
		3VA5191-1MH31-0AA0	50 ... 120
	15	3VA5195-1MU31-0AA0	45 ... 105
		3VA5195-1MH31-0AA0	75 ... 180
	25	3VA5125-1MU31-0AA0	75 ... 175
		3VA5125-1MH31-0AA0	125 ... 300
	30	3VA5130-1MU31-0AA0	90 ... 210
		3VA5130-1MH31-0AA0	150 ... 360
	40	3VA5140-1MU31-0AA0	120 ... 280
		3VA5140-1MH31-0AA0	200 ... 480
	50	3VA5150-1MU31-0AA0	150 ... 350
		3VA5150-1MH31-0AA0	250 ... 600
	70	3VA5170-1MU31-0AA0	210 ... 490
		3VA5170-1MH31-0AA0	350 ... 840
80	3VA5180-1MU31-0AA0	240 ... 560	
	3VA5180-1MH31-0AA0	400 ... 960	
90	3VA5190-1MU31-0AA0	270 ... 630	
	3VA5190-1MH31-0AA0	450 ... 1080	
100	3VA5110-1MU31-0AA0	300 ... 700	
	3VA5110-1MH31-0AA0	500 ... 1200	
110	3VA5111-1MU31-0AA0	330 ... 770	
	3VA5111-1MH31-0AA0	550 ... 1320	
125	3VA5112-1MU31-0AA0	375 ... 875	
	3VA5112-1MH31-0AA0	625 ... 1500	
150	3VA5215-0MU31-0AA0	450 ... 900	
	3VA5215-0MH31-0AA0	900 ... 1800	
200	3VA5220-0MU31-0AA0	600 ... 1200	
	3VA5220-0MH31-0AA0	1200 ... 2400	
250	3VA5325-0MU31-0AA0	750 ... 1500	
	3VA5325-0MH31-0AA0	1500 ... 3000	

Motor circuit protector TM120M AM^{®2}

3VA52 (CFAP)	150	3VA5215-1MU31-0AA0	450 ... 900
		3VA5215-1MH31-0AA0	900 ... 1800
	200	3VA5220-1MU31-0AA0	600 ... 1200
		3VA5220-1MH31-0AA0	1200 ... 2400

Motor circuit protector TM120M AM^{®2}

Frame (Breaker Type)	Maximum Ampere Rating	3-Pole Catalog Number	Instantaneous short circuit protection
3VA54 (HLAP)	400	3VA5440-0MU31-0AA0	750 ... 1500
		3VA5440-0MH31-0AA0	1200 ... 2400
	500	3VA5450-0MU31-0AA0	1500 ... 3000
		3VA5450-0MH31-0AA0	3000 ... 6000
	600	3VA5460-0MU31-0AA0	1800 ... 3600
		3VA5460-0MH31-0AA0	3000 ... 6000
3VA55 (HMAP)	600	3VA5560-0MH31-0AA0	4800 ... 9600
3VA52 (CFAP)	150	3VA5215-1MU31-0AA0	450 ... 900
		3VA5215-1MH31-0AA0	900 ... 1800
	200	3VA5220-1MU31-0AA0	600 ... 1200
		3VA5220-1MH31-0AA0	1200 ... 2400
250	3VA5225-1MH31-0AA0	750 ... 900	
	3VA5225-1MU31-0AA0	1250 ... 2500	
3VA53 (CJAP)	250	3VA5325-1MU31-0AA0	750 ... 1500
3VA54 (CLAP)	400	3VA5440-1MU31-0AA0	750 ... 1500
		3VA5440-1MH31-0AA0	2400 ... 4800
500	3VA5450-1MU31-0AA0	1500 ... 3000	
	3VA5450-1MH31-0AA0	3000 ... 6000	
600	3VA5460-1MU31-0AA0	1500 ... 3000	
	3VA5460-1MH31-0AA0	3000 ... 6000	
3VA55 (CMAP)	600	3VA5560-1MH31-0AA0	4800 ... 9600

Motor circuit protector ETU310M^{®2}

Frame (Breaker Type)	Maximum Ampere Rating	3-Pole Catalog Number	Instantaneous short circuit protection	
3VA61 (CDAR)	25	3VA6125-1MS31-0AA0	75 ... 375	
	30	3VA6130-1MS31-0AA0	90 ... 450	
	40	3VA6140-1MS31-0AA0	120 ... 600	
	50	3VA6150-1MS31-0AA0	150 ... 750	
	70	3VA6170-1MS31-0AA0	210 ... 1050	
	80	3VA6180-1MS31-0AA0	240 ... 1200	
	90	3VA6190-1MS31-0AA0	270 ... 1350	
	100	3VA6110-1MS31-0AA0	300 ... 1500	
	3VA62 (CFAR-Y)	110	3VA6211-1MS31-0AA0	330 ... 1650
		125	3VA6212-1MS31-0AA0	375 ... 1875
150		3VA6215-1MS31-0AA0	450 ... 2250	
200		3VA6220-1MS31-0AA0	600 ... 2400	
3VA63 (CJAR)	200	3VA6320-1MS31-0AA0	600 ... 3000	
3VA64 (CLAR)	250	3VA6325-1MS31-0AA0	750 ... 3750	
	400	3VA6440-1MS31-0AA0	1200 ... 5200	
3VA65 (CMAR)	500	3VA6450-1MS31-0AA0	1500 ... 6000	
	800	3VA6580-1MS31-0AA0	2400 ... 12000	

Interrupting Ratings

Frame	Breaker Type	RMS Symmetrical Amperes (kA)							
		Volts AC (50/60 Hz)				Volts DC			
		240	480	600Y/ 347V	600	125 (1P)	250 (2P)	500 ^② (3P)	600 (3P)
3VA51	HEAP	150	65	25	—	30	100	100	—
3VA52	HFAP	100	65	25	25	—	—	85	85
	CFAP	200	100	35	35	—	—	100	100
3VA53	HJAP	100	65	25	25	—	—	—	—
	CHAP	200	100	35	35	—	—	—	—
3VA54	HLAP	100	65	25	25	—	—	—	—
	CLAP	200	100	35	35	—	—	—	—
3VA55	HMAP	100	65	25	—	—	—	—	—
	CMAP	100	100	50	—	—	—	—	—
3VA61	CDAR	200	100	35	35	—	—	—	—
3VA62	CFAR	200	100	35	35	—	—	—	—
3VA63	CJAR	200	100	35	35	—	—	—	—
3VA64	CLAR	200	100	35	35	—	—	—	—
3VA65	CMAR	200	100	42	—	—	—	—	—



Motor Circuit Protector

- ① Rated at 600 Y/347 V AC.
- ② SCCR is 35kA at 600V. SCCR rating is the maximum permissible short circuit current of the MCP in combination with an appropriate overload protection device.
- ③ SCCR is 25kA at 600V. SCCR rating is the maximum permissible short circuit current of the MCP in combination with an appropriate overload protection device.
- ④ 2 poles required for 500VDC for breaker types HFAP and CFAP.

Molded Case Circuit Breakers

3VA Internal Accessories

Selection

Internal Accessories

Auxiliary and Alarm Switches

Switch Type	Catalog Number		
	HP High Power (2 slots)	HQ Compact (1 slot)	HQ Electronic ^① (1 slot)
Auxiliary Switch (AUX)	3VA9978-0AA11	3VA9978-0AA12	3VA9978-0AA13
Leading Changeover Switch (LCS)	3VA9978-0AA21	3VA9978-0AA22	3VA9978-0AA23
Trip Alarm Switch (TAS)	3VA9978-0AB11	3VA9978-0AB12	3VA9978-0AB13
Electronic Alarm (EAS)	—	3VA9978-0AB22	3VA9978-0AB23

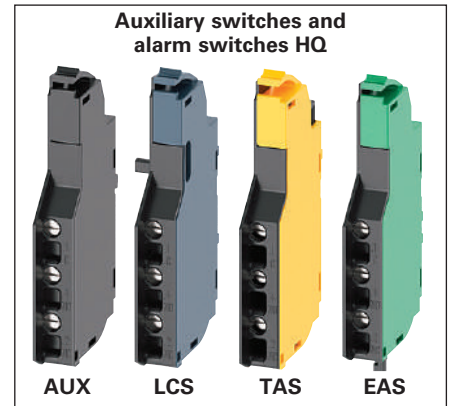

Shunt Trips

Type	VAC 50/60 Hz	VDC	Catalog Number (3 slots)
Shunt Trip Left (STL)	380 ... 600	—	3VA9978-0BL20
	—	12	3VA9978-0BL10
	24	24 ... 30	3VA9978-0BL30
	48 ... 60	—	3VA9978-0BL31
	110 ... 127	110 ... 127	3VA9978-0BL32
	208 ... 277	220 ... 250	3VA9978-0BL33
Shunt Trip Flexible (STF) ^②	24	—	3VA9978-0BA20
	48 ... 60	—	3VA9978-0BA21
	110 ... 127	—	3VA9978-0BA22
	208 ... 277	—	3VA9978-0BA23
	380 ... 500	—	3VA9978-0BA24
	600	—	3VA9978-0BA25

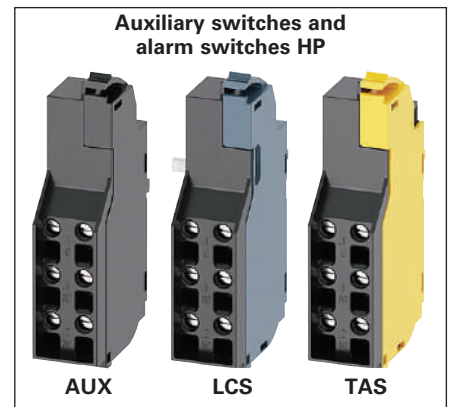

Undervoltage Release

Undervoltage Release (UVR)	—	12	3VA9978-0BB10
	—	24	3VA9978-0BB11
	—	48	3VA9978-0BB12
	—	125 ... 127	3VA9978-0BB14
	—	250	3VA9978-0BB16
	24	—	3VA9978-0BB20
	120 ... 127	—	3VA9978-0BB24
	208 ... 230	—	3VA9978-0BB25
	440 ... 480	—	3VA9978-0BB27



Universal Release (Undervoltage and Shunt trip)

Universal Release (UNI)	—	12	3VA9978-0BD11
	—	24	3VA9978-0BD12
	—	48	3VA9978-0BD13



Time-delay Device for Undervoltage Release

Type	VAC 50/60 Hz	VDC	Delay Time	Catalog Number
Time-delay Device	230	230	Fixed – 100ms minimum	3VA9978-0BF22
	—	24	Fixed – 100ms minimum	3VA9978-0BF23

^① Use only with 3VA6.

^② Shunt trip flexible can be used in the left pocket of the 3VA5 breakers. They can be used in the left or right pocket of the 3VA6 breakers.

Molded Case Circuit Breakers

3VA Manual Operators

Selection

Front Mounted Rotary Operator



	Type	Color	3VA5 125A	3VA5 250A	3VA6 150A 250A	3VA5 3VA6 400A 600A	3VA5 3VA6 800A 1000A	Catalog Number
 <p>Degree of protection NEMA 1</p>	Standard without illumination kit	Gray	✓	—	—	—	—	3VA9137-0EK11
			—	✓	✓	—	—	3VA9277-0EK11
			—	—	—	✓	—	3VA9447-0EK11
			—	—	—	—	✓	3VA9677-0EK11
	Standard with illumination kit	Gray	✓	—	—	—	—	3VA9137-0EK13
			—	✓	✓	—	—	3VA9277-0EK13
			—	—	—	✓	—	3VA9447-0EK13
	EMERGENCY-OFF without illumination kit	Yellow-Red	✓	—	—	—	—	3VA9137-0EK15
			—	✓	✓	—	—	3VA9277-0EK15
			—	—	—	✓	—	3VA9447-0EK15
			—	—	—	—	✓	3VA9677-0EK15
	EMERGENCY-OFF with illumination kit	Yellow-Red	✓	—	—	—	—	3VA9137-0EK17
			—	✓	✓	—	—	3VA9277-0EK17
			—	—	—	✓	—	3VA9447-0EK17
	Standard with door interlock	Gray	✓	—	—	—	—	3VA9137-0EK21
			—	✓	✓	—	—	3VA9277-0EK21
			—	—	—	✓	—	3VA9447-0EK21
			—	—	—	—	✓	3VA9677-0EK21
	Standard with door interlock, with illumination kit	Gray	✓	—	—	—	—	3VA9137-0EK23
			—	✓	✓	—	—	3VA9277-0EK23
—			—	—	✓	—	3VA9447-0EK23	
EMERGENCY-OFF with door interlock	Yellow-Red	✓	—	—	—	—	3VA9137-0EK25	
		—	✓	✓	—	—	3VA9277-0EK25	
		—	—	—	✓	—	3VA9447-0EK25	
		—	—	—	—	✓	3VA9677-0EK25	
EMERGENCY-OFF with door interlock, with illumination kit	Yellow-Red	✓	—	—	—	—	3VA9137-0EK27	
		—	✓	✓	—	—	3VA9277-0EK27	
		—	—	—	✓	—	3VA9447-0EK27	
Standard with door interlock, with door open function	Gray	✓	—	—	—	—	3VA9137-0EK31	
		—	✓	✓	—	—	3VA9277-0EK31	
		—	—	—	✓	—	3VA9447-0EK31	
		—	—	—	—	✓	3VA9677-0EK31	
Standard with door interlock, with door open function, with illumination kit	Gray	✓	—	—	—	—	3VA9137-0EK33	
		—	✓	✓	—	—	3VA9277-0EK33	
		—	—	—	✓	—	3VA9447-0EK33	
		—	—	—	—	✓	3VA9677-0EK33	
EMERGENCY-OFF with door interlock, with door open function	Yellow-Red	✓	—	—	—	—	3VA9137-0EK35	
		—	✓	✓	—	—	3VA9277-0EK35	
		—	—	—	✓	—	3VA9447-0EK35	
		—	—	—	—	✓	3VA9677-0EK35	
EMERGENCY-OFF with door interlock, with door open function, with illumination kit	Yellow-Red	✓	—	—	—	—	3VA9137-0EK37	
		—	✓	✓	—	—	3VA9277-0EK37	
		—	—	—	✓	—	3VA9447-0EK37	

Molded Case Circuit Breakers

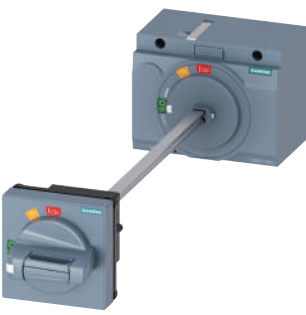

3VA Manual Operators

Selection

Door Mounted Rotary Operator^①

	Type	Color	3VA5	3VA5	3VA6	3VA5	3VA5	Catalog Number
			125A	250A	150A 250A	3VA6 400A 600A	3VA6 800A 1000A	
 <p>Degree of protection Type 1, 12, 3R and 4X</p>	Standard	Gray	✓	—	—	—	—	3VA9137-0FK21
			—	✓	✓	—	—	3VA9277-0FK21
			—	—	—	✓	—	3VA9447-0FK21
			—	—	—	—	✓	3VA9677-0FK21
	Standard with illumination kit	Gray	✓	—	—	—	—	3VA9137-0FK23
			—	✓	✓	—	—	3VA9277-0FK23
			—	—	—	✓	—	3VA9447-0FK23
			—	—	—	—	✓	3VA9677-0FK23
	EMERGENCY-OFF	Yellow-Red	✓	—	—	—	—	3VA9137-0FK25
			—	✓	✓	—	—	3VA9277-0FK25
			—	—	—	✓	—	3VA9447-0FK25
			—	—	—	—	✓	3VA9677-0FK25
	EMERGENCY-OFF with illumination kit	Yellow-Red	✓	—	—	—	—	3VA9137-0FK27
			—	✓	✓	—	—	3VA9277-0FK27
			—	—	—	✓	—	3VA9447-0FK27
			—	—	—	—	✓	3VA9677-0FK27
	Standard with door interlock, with open door function	Gray	✓	—	—	—	—	3VA9137-0FK31
			—	✓	✓	—	—	3VA9277-0FK31
		—	—	—	✓	—	3VA9447-0FK31	
		—	—	—	—	✓	3VA9677-0FK31	
Standard with door interlock, with open door function with illumination kit	Gray	✓	—	—	—	—	3VA9137-0FK33	
		—	✓	✓	—	—	3VA9277-0FK33	
		—	—	—	✓	—	3VA9447-0FK33	
		—	—	—	—	✓	3VA9677-0FK33	
EMERGENCY-OFF with door interlock, with open door function	Yellow-Red	✓	—	—	—	—	3VA9137-0FK35	
		—	✓	✓	—	—	3VA9277-0FK35	
		—	—	—	✓	—	3VA9447-0FK35	
		—	—	—	—	✓	3VA9677-0FK35	
EMERGENCY-OFF with door interlock, with open door function, with illumination kit	Yellow-Red	✓	—	—	—	—	3VA9137-0FK37	
		—	✓	✓	—	—	3VA9277-0FK37	
		—	—	—	✓	—	3VA9447-0FK37	
		—	—	—	—	✓	3VA9677-0FK37	
 <p>NFPA-79 Supplementary Handles</p>	Standard	Gray	✓	—	—	—	—	3VA9137-0GC01
			—	✓	✓	—	—	3VA9477-0GC01
			—	—	—	✓	—	3VA9477-0GC11
			—	—	—	—	✓	3VA9677-0GC01
	EMERGENCY-OFF	Yellow-Red	✓	—	—	—	—	3VA9137-0GC05
			—	✓	✓	—	—	3VA9477-0GC05
			—	—	—	✓	—	3VA9477-0GC15
			—	—	—	—	✓	3VA9677-0GC05

Side Mounted Rotary Operator^①

 <ul style="list-style-type: none"> Without mounting plate Rotary operator with shaft 300 mm Handle with masking plate 75 x 75 mm Degree of protection Type 1, 12, 3R, 4X 	Standard	Gray	✓	—	—	—	—	3VA9137-0PK11	
			—	✓	✓	—	—	3VA9277-0PK11	
	Standard with illumination kit	Gray	✓	—	—	—	—	—	3VA9137-0PK13
			—	✓	✓	—	—	—	3VA9277-0PK13
	EMERGENCY-OFF	Yellow-Red	✓	—	—	—	—	—	3VA9137-0PK15
			—	✓	✓	—	—	—	3VA9277-0PK15
 <ul style="list-style-type: none"> With mounting plate Rotary operator with short shaft Handle with masking plate 75 x 75 mm Degree of protection Type 1, 12, 3R, 4X 	Standard with mounting plate	Gray	✓	—	—	—	—	3VA9137-0PK51	
			—	✓	✓	—	—	3VA9277-0PK51	
	Standard with mounting plate, with illumination kit	Gray	✓	—	—	—	—	—	3VA9137-0PK53
			—	✓	✓	—	—	—	3VA9277-0PK53
	EMERGENCY-OFF with mounting plate	Yellow-Red	✓	—	—	—	—	—	3VA9137-0PK55
			—	✓	✓	—	—	—	3VA9277-0PK55
	EMERGENCY-OFF with mounting plate, with illumination kit	Yellow-Red	✓	—	—	—	—	—	3VA9137-0PK57
			—	✓	✓	—	—	—	3VA9277-0PK57
 <p>Side Mounted Rotary Operator Door Interlock</p>	Standard for use with the side wall mounted rotary operators	Gray	✓	—	—	—	—	3VA9177-0VF40	
	Without mounting plate		—	✓	✓	—	—	3VA9277-0VF40	

① Lockable with up to three padlock hasps.

Molded Case Circuit Breakers

3VA Manual Operators

Selection

Breaker Operator

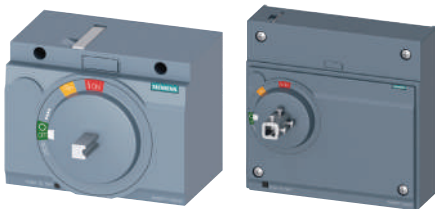
		Type	Color	3VA5 125A	3VA5 250A	3VA6 150A 250A	3VA5 3VA6 400A 600A	3VA5 3VA6 800A 1000A	Catalog Number
 <p>3VA9277-0GK00 3VA9677-0GK00</p>	Without handle, with shaft stub, without door interlock For retrofit with 3VL handle	Gray	✓	—	—	—	—	3VA9137-0GK00	
			—	✓	✓	—	—	3VA9277-0GK00	
			—	—	—	✓	—	3VA9447-0GK00	
			—	—	—	—	✓	3VA9677-0GK00	

Handles with Masking Plate (Purchase breaker operator, shaft and shaft adapter separately)

 <ul style="list-style-type: none"> Degree of protection Type 1, 12, 3R and 4X 	Standard	Gray	Without	Without	✓	✓	✓	—	—	Catalog Number
	EMERGENCY-OFF	Yellow-Red	Without	Without	✓	✓	✓	—	—	8UD1721-0AB11
With			Without	✓	✓	✓	—	—	8UD1721-0AB21	
Without			Without	—	—	—	✓	—	8UD1731-0AB11	
With			Without	—	—	—	✓	—	8UD1731-0AB21	
Without			With	✓	✓	✓	—	—	8UD1721-0AC11	
With			With	✓	✓	✓	—	—	8UD1721-0AC21	
Without			With	—	—	—	✓	—	8UD1731-0AC11	
With			With	—	—	—	✓	—	8UD1731-0AC21	
Without			With	—	—	—	—	✓	8UD1741-0AB11	
With			With	—	—	—	—	✓	8UD1741-0AB21	
Without			Without	✓	✓	✓	—	—	8UD1721-0AB15	
With			Without	✓	✓	✓	—	—	8UD1721-0AB25	
Without			Without	—	—	—	✓	—	8UD1731-0AB15	
With			Without	—	—	—	✓	—	8UD1731-0AB25	
Without			With	✓	✓	✓	—	—	8UD1721-0AC15	
With			With	✓	✓	✓	—	—	8UD1721-0AC25	
Without			With	—	—	—	✓	—	8UD1731-0AC15	
With			With	—	—	—	✓	—	8UD1731-0AC25	
Without	With	—	—	—	—	✓	8UD1741-0AB15			
With	With	—	—	—	—	✓	8UD1741-0AB25			

5 MOLDED CASE CIRCUIT BREAKERS

Metal Rotary Handles (Purchase breaker operator, shaft and shaft adapter separately)

	Type	Color	Tolerance Compensation	Door Open Function	3VA5 125A	3VA5 250A	3VA6 150A 250A	3VA5 3VA6 400A 600A	3VA5 3VA6 800A 1000A	Catalog Number
 <ul style="list-style-type: none"> Large, degree of protection Type 1, 3, 3R, 12 	Metal	Black	—	With	✓	✓	✓	✓	✓	RHOH
<ul style="list-style-type: none"> Large, degree of protection Type 4, 4X 	Metal	Stainless	—	With	✓	✓	✓	✓	✓	RHOH4
<ul style="list-style-type: none"> Compact, degree of protection Type 1,3,3R,12 	Compact	Black	—	With	✓	✓	✓	✓	—	RHOHC
<ul style="list-style-type: none"> Compact, degree of protection Type 4, 4X 	Compact	Stainless	—	With	✓	✓	✓	✓	—	RHOH4C
<ul style="list-style-type: none"> Long, degree of protection 1,3,3R,12 	Emergency	Red	—	With	✓	✓	✓	✓	✓	RHVPEMH
<ul style="list-style-type: none"> Compact, degree of protection 1,3,3R,12 	Emergency	Red	—	With	✓	✓	✓	✓	—	RHVMEMH



For additional information for selecting handle and breaker operator combinations, please refer to the brochure: https://digitalcontentcenter.compas.siemens-info.com/SIE_FL_3VA_Handles.pdf

Molded Case Circuit Breakers

3VA Manual Operators

Selection

Pistol Grip Handles (Purchase breaker operator, shaft and shaft adapter separately)

	Type	Color	Tolerance Compensation	Door Open Function	3VA5 125A	3VA5 250A	3VA6 150A 250A	3VA5 3VA6 400A 600A	3VA5 3VA6 800A 1000A	Catalog Number
 ■ Degree of protection Type 1,3R,12	Plastic	Gray	—	With	✓	✓	✓	✓	—	3VA9477-0FH11
 ■ Degree of protection Type 1,3R,12	Emergency	Red	—	With	✓	✓	✓	✓	—	3VA9477-0FH15

Door Mounted Rotary Operator Accessories









	Type	3VA5 125A	3VA5 250A	3VA6 150A 250A	3VA5 3VA6 400A 600A	3VA5 3VA6 800A 1000A	Catalog Number
	8 mm Shaft 300 mm long (for 8UD plastic handles) (Fixing bracket optional)	✓	✓	✓	✓	—	8UD1900-2WA00
	8 mm Shaft 600 mm long (for 8UD plastic handles) (Fixing bracket required)	✓	✓	✓	✓	—	8UD1900-2WB00
	12 mm Shaft 325 mm long (for 8UD plastic handles)	—	—	—	—	✓	8UD1900-4WA00
	12 mm Shaft 600 mm long (for 8UD plastic handles)	—	—	—	—	✓	8UD1900-4WB00
	8 mm Shaft 300 mm long (for metal handles) (Fixing bracket optional)	✓	✓	✓	✓	—	3VA9477-0GF20
	8 mm Shaft 600 mm long (for metal handles) (Fixing bracket required)	✓	✓	✓	✓	—	3VA9477-0GF21
	12 mm Shaft 300 mm long (for metal handles) (Fixing bracket optional)	—	—	—	—	✓	3VA9877-0GF22
	12 mm Shaft 600 mm long (for metal handles) (Fixing bracket required)	—	—	—	—	✓	3VA9877-0GF23
	8 mm Shaft 300 mm long (for pistol grip handles) (Fixing bracket optional)	✓	✓	✓	✓	—	3VA9477-0GF10
	8 mm Shaft 600 mm long (for pistol grip handles) (Fixing bracket required)	✓	✓	✓	✓	—	3VA9477-0GF11
	Adapter for 8 mm Shaft for door mounted operator	✓	✓	✓	✓	—	8UD1900-2DA00
	Adapter for 12 mm Shaft for door mounted operator	—	—	—	—	✓	8UD1900-4DA00
	Door Coupling 8 mm x 8 mm (for 8UD plastic handles)	✓	✓	✓	—	—	8UD1900-2HA00
	Door coupling 12 mm x 12 mm (for 8UD plastic handles)	—	—	—	✓	✓	8UD1900-4HA00
	Fixing bracket for Shaft	✓	—	—	—	—	3VA9137-0GA80
		—	✓	✓	✓	—	3VA9477-0GA80
	Fixing bracket for 12 mm x 12 mm shaft	—	—	—	—	✓	3VA9677-0GA80
	Variable depth adapter 8 x 8 mm	✓	✓	✓	✓	—	3VA9487-0GB10
	Mounting tolerance compensation 8 x 8 mm (for 8UD plastic handles)	✓	✓	✓	✓	—	8UD1900-2GA00
	Mounting tolerance compensation 12 mm x 12 mm (for 8UD plastic handles)	—	—	—	—	✓	8UD1900-4GA00

Molded Case Circuit Breakers

3VA Manual Operators

Selection

General Accessories for Manual Operators

	Type	Details	Part Number	
	Labeling plate for manual operators	—	3VA9087-0SX10	
	Illumination kit for manual operators 24 V DC voltage	For Molded Case Circuit Breakers		
		3VA5, 125...250 A	Front mounted rotary operators	8UD1900-0KA10
		3VA6, 150...600 A	Front mounted rotary operators	8UD1900-0KA20
		3VA5, 3VA6, 125...600 A	Door mounted rotary operators	8UD1900-0KA20
	Cylinder Lock (type Kaba) ■ For 8UD plastic door mounted rotary operators (in masking plate) ■ Standard masking plate	Key 1	8UD1900-0MB01	
		Key 2	8UD1900-0NB01	
		Key 3	8UD1900-0PB01	
		Key 4	8UD1900-0QB01	
	Cylinder Lock (type Kaba) [Ⓞ] ■ For 8UD plastic door mounted rotary operators (in masking plate) ■ Standard masking plate	Key 1	8UD1900-0MC01	
		Key 2	8UD1900-0NC01	
		Key 3	8UD1900-0PC01	
		Key 4	8UD1900-0QC01	
	Cylinder Lock (type Kaba) ■ For 8UD plastic door mounted rotary operators (in masking plate) ■ EMERGENCY-OFF masking plate	Key 1	8UD1900-0MB05	
		Key 2	8UD1900-0NB05	
		Key 3	8UD1900-0PB05	
		Key 4	8UD1900-0QB05	
	Cylinder Lock (type Kaba) [Ⓞ] ■ For 8UD plastic door mounted rotary operators (in masking plate) ■ EMERGENCY-OFF masking plate	Key 1	8UD1900-0MC05	
		Key 2	8UD1900-0NC05	
		Key 3	8UD1900-0PC05	
		Key 4	8UD1900-0QC05	
	Cylinder Lock (type Ronis) ■ includes 2 keys ■ for locking or interlocking ■ installation in all rotary operators w/ shaft stub	Key 1	3VA9980-0VL10	
		Key 3	3VA9980-0VL30	
		Key 4	3VA9980-0VL40	
	Cylinder lock adapter for 8UD rotary operator ■ to mount in rotary operator		3VA9980-0LF20	
	Cylinder lock adaptor for front mounted rotary operator 3VA9677-0EK.. and door mounted rotary operator 3VA9677-0FK.. 3VA55/3VA65/3VA66		3VA9670-0LF20	

5
MOLDED CASE
CIRCUIT BREAKERS

Variable depth flange mounted operator kit

	Type	3VA5 125A	3VA5 250A	3VA6 150A 250A	3VA5 3VA6 400A 600A	Catalog Number
	Complete kit comprising: ■ Switching mechanism adjustable depth 200mm to 400mm ■ Epoxy coated steel handle, NEMA 1/3R/12, black = OFF, red = ON	✓	—	—	—	3VA9138-0DK72
		—	✓	✓	—	3VA9278-0DK72
		—	—	—	✓	3VA9478-0DK72
	Complete kit comprising: ■ Switching mechanism adjustable depth 200mm to 400mm ■ Stainless steel handle, chrome-plated NEMA 4/4X, black=OFF, red=ON	✓	—	—	—	3VA9138-0DK82
		—	✓	✓	—	3VA9278-0DK82
		—	—	—	✓	3VA9478-0DK82
	Complete kit comprising: ■ Switching mechanism adjustable depth 200mm to 400mm ■ Handle stainless steel, chrome-plated NEMA 4/4X, black=OFF, black=ON	✓	—	—	—	3VA9138-0DK84
		—	✓	✓	—	3VA9278-0DK84
		—	—	—	✓	3VA9478-0DK84





Ⓞ With door open function

Molded Case Circuit Breakers

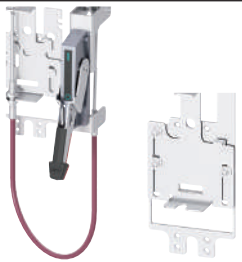

3VA Manual and Motor Operators

Selection

Max Flex Operator

	Type	3VA5 125A	3VA5 250A	3VA6 150A 250A	3VA5 3VA6 400A 600A	Catalog Number
 <p>Complete kit and spare mechanism</p>	Complete Kit	✓	—	—	—	3VA9137-0CK12
	<ul style="list-style-type: none"> Operating mechanism Plastic handle, NEMA 1/12, black=OFF, green=ON Bowden Cable 36 inches (0.9m) long 	—	✓	✓	—	3VA9277-0CK12
	<ul style="list-style-type: none"> Operating mechanism Steel handle, epoxy coated NEMA 1/3R/12, black=OFF, red=ON, Bowden Cable 36 inches (0.9m) long 	—	—	—	✓	3VA9477-0CK12
	Complete Kit	✓	—	—	—	3VA9137-0CK72
	<ul style="list-style-type: none"> Operating mechanism Steel handle, epoxy coated NEMA 1/3R/12, black=OFF, red=ON, Bowden Cable 36 inches (0.9m) long 	—	✓	✓	—	3VA9277-0CK72
	<ul style="list-style-type: none"> Operating mechanism Steel handle, epoxy coated NEMA 1/3R/12, black=OFF, black=ON Bowden Cable 36 inches (0.9m) long 	—	—	—	✓	3VA9477-0CK72
	Operating Mechanism (spare)	✓	—	—	—	3VA9137-0CB10
		—	✓	✓	—	3VA9277-0CB10
		—	—	—	✓	3VA9477-0CB10
		Handle - Plastic, NEMA 1/12, black = OFF, green = ON	✓	✓	✓	✓
Handle - Steel, Epoxy coated, NEMA 1/3R/12, black = OFF, red = ON		✓	✓	✓	✓	3VA9977-0CH72
Handle - Steel, Epoxy coated, NEMA 1/3R/12, black = OFF, black = ON		✓	✓	✓	✓	3VA9977-0CH74
Handle - Steel, chrome-plated, NEMA 4/4X, black = OFF, red = ON		✓	✓	✓	✓	3VA9977-0CH82
Handle - Steel, chrome-plated, NEMA 4/4X, black = OFF, black = ON		✓	✓	✓	✓	3VA9977-0CH84
	Bowden Cable, 36 inches (0.9m)	✓	✓	✓	—	3VA9278-0CC10
	Bowden Cable, 48 inches (1.2m)	✓	✓	✓	—	3VA9278-0CC20
	Bowden Cable, 60 inches (1.5m)	✓	✓	✓	—	3VA9278-0CC30
	Bowden Cable, 72 inches (1.8m)	✓	✓	✓	—	3VA9278-0CC40
	Bowden Cable, 84 inches (2.1m)	✓	✓	✓	—	3VA9278-0CC50
	Bowden Cable, 96 inches (2.4m)	✓	✓	✓	—	3VA9278-0CC60
	Bowden Cable, 120 inches (3.0m)	✓	✓	✓	—	3VA9278-0CC70
	Bowden Cable, 144 inches (3.6m)	✓	✓	✓	—	3VA9278-0CC80
	Bowden Cable, 36 inches (0.9m)	—	—	—	✓	3VA9578-0CC10
	Bowden Cable, 48 inches (1.2m)	—	—	—	✓	3VA9578-0CC20
	Bowden Cable, 60 inches (1.5m)	—	—	—	✓	3VA9578-0CC30
	Bowden Cable, 72 inches (1.8m)	—	—	—	✓	3VA9578-0CC40
	Bowden Cable, 84 inches (2.1m)	—	—	—	✓	3VA9578-0CC50
	Bowden Cable, 96 inches (2.4m)	—	—	—	✓	3VA9578-0CC60
	Bowden Cable, 120 inches (3.0m)	—	—	—	✓	3VA9578-0CC70
	Bowden Cable, 144 inches (3.6m)	—	—	—	✓	3VA9578-0CC80
		MaxFlex Auxiliary switch (leading from On to Off)	✓	✓	✓	✓
<ul style="list-style-type: none"> 1 CO 		✓	✓	✓	✓	3VA9478-0CX20
	MaxFlex Auxiliary switch (leading from On to Off)	✓	✓	✓	✓	3VA9478-0CX20
	<ul style="list-style-type: none"> 2 CO 	✓	✓	✓	✓	3VA9478-0CX20

Motor Operators^①

	Type	3VA5 125 A	3VA5 250 A	3VA6 150 A 250 A	3VA5 3VA6 400A 600A	Part Number
	Motor Operator without Stored Energy Feature					
	24 ... 60 V DC	✓	—	—	—	3VA9137-0HA10
		—	✓	✓	—	3VA9277-0HA10
		—	—	—	✓	3VA9447-0HA10
	110 ... 230 V AC	✓	—	—	—	3VA9137-0HA20
	110 ... 250 V DC	—	✓	✓	—	3VA9277-0HA20
	—	—	—	✓	3VA9447-0HA20	
	Motor Operator with Stored Energy Feature					
	24 V DC	—	✓	✓	—	3VA9277-0HC10
	42 ... 60 V AC/DC	—	✓	✓	—	3VA9277-0HC20
	110 ... 230 V AC / 110 ... 250 V DC	—	✓	✓	—	3VA9277-0HC30
	Motor Operator with Stored Energy Feature with Communication					
	24 V DC	—	✓	✓	—	3VA9277-0HC15
110 ... 230 V AC / 110 ... 250 V DC	—	✓	✓	—	3VA9277-0HC35	





① Lockable with up to three padlock hasps.

Molded Case Circuit Breakers











3VA Connection Technology

Selection

Box Terminals

	Type	Minimum cable cross-section (standard) Class B	Maximum cable cross-section (standard) Class B	For molded case circuit breakers/ rated current					Part Number
				3VA5 125A	3VA5 250A	3VA6 150A 250A	3VA5 3VA6 400A 600A	3VA5 3VA6 800A 1000A	
	Steel wrap-around lug (Cu cable only) kit of 3 single lugs	AWG 14	3/0	✓	—	—	—	—	3VA9133-0JA11
		AWG 10	3/0	—	✓	—	—	—	3VA9233-0JA11
		AWG 4	350 kcmil	—	✓	—	—	—	3VA9233-0JA12
		AWG 10	3/0	—	—	✓	—	—	3VA9143-0JA12
		AWG 4	350 kcmil	—	—	✓	—	—	3VA9243-0JA12
	Steel wrap-around lug (Cu cable only) kit of 4 single lugs	1/0	500 kcmil	—	—	—	✓	—	3VA9473-0JA13
		AWG 14	AWG 10	✓	—	—	—	—	3VA9134-0JA11
		AWG 10	3/0	—	✓	—	—	—	3VA9234-0JA11
		AWG 10	3/0	—	—	✓	—	—	3VA9144-0JA12
		AWG 4	350 kcmil	—	✓	—	—	—	3VA9234-0JA12
	Steel wrap-around lug with control wire tap (Cu cable only) kit of 3 single lugs	AWG 4	350 kcmil	—	✓	—	—	—	3VA9244-0JA12
		AWG 10	3/0	—	—	✓	—	—	3VA9143-0JH12
		AWG 4	350 kcmil	—	—	✓	—	—	3VA9243-0JH12
		1/0	500 kcmil	—	—	—	✓	—	3VA9473-0JH13
		AWG 10	3/0	—	✓	—	—	—	3VA9234-0JH11
	Steel wrap-around lug with control wire tap (Cu cable only) kit of 4 single lugs	AWG 4	350 kcmil	—	✓	—	—	—	3VA9234-0JH12
		AWG 10	3/0	—	—	✓	—	—	3VA9144-0JH12
		AWG 4	350 kcmil	—	—	✓	—	—	3VA9244-0JH12
		1/0	500 kcmil	—	—	—	✓	—	3VA9474-0JH13
		AWG 10	3/0	—	✓	—	—	—	3VA9234-0JH11

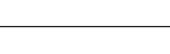
Aluminum Wire Connectors

	Aluminum body lug small (Cu/Al cable) kit of 3 single lugs	AWG 14	AWG 10	✓	—	—	—	—	3VA9133-0JB10
	Aluminum body lug small (Cu/Al cable) kit of 4 single lugs	AWG 14	AWG 10	✓	—	—	—	—	3VA9134-0JB10
	Aluminum body lug small with control wire tap (Cu/Al cable)	AWG 14	AWG 10	✓	—	—	—	—	3VA9133-0JG10
	Aluminum body lug small with control wire tap (Cu/Al cable)	AWG 14	AWG 10	✓	—	—	—	—	3VA9134-0JG10
	Aluminum body lug (Cu/Al cable) kit of 3 single lugs	AWG 14	3/0	✓	—	—	—	—	3VA9133-0JB11
		AWG 14	1/0	—	✓	—	—	—	3VA9233-0JB11
		AWG 6	350 kcmil	—	✓	—	—	—	3VA9233-0JB12 ^②
		AWG 14	1/0	—	—	✓	—	—	3VA9143-0JB11 ^②
		AWG 6	350 kcmil	—	—	✓	—	—	3VA9243-0JB12
	Aluminum body lug (Cu/Al cable) kit of 4 single lugs	AWG 1	600 kcmil	—	—	—	✓	—	3VA9373-0JB13 ^①
		AWG 14	AWG 10	✓	—	—	—	—	3VA9134-0JB11
		AWG 14	1/0	—	✓	—	—	—	3VA9234-0JB11
		AWG 14	1/0	—	—	✓	—	—	3VA9144-0JB11 ^②
		AWG 6	350 kcmil	—	✓	—	—	—	3VA9234-0JB12
	Aluminum body lug with control wire tap (Cu/Al cable) kit of 3 single lugs	AWG 6	350 kcmil	—	—	✓	—	—	3VA9244-0JB12 ^②
		AWG 1	600 kcmil	—	—	—	✓	—	3VA9374-0JB13 ^①
		AWG 14	3/0	✓	—	—	—	—	3VA9133-0JG11
		AWG 14	1/0	—	✓	—	—	—	3VA9233-0JG11
		AWG 6	350 kcmil	—	✓	—	—	—	3VA9233-0JG12
	Aluminum body lug with control wire tap (Cu/Al cable) kit of 4 single lugs	AWG 14	1/0	—	—	✓	—	—	3VA9143-0JG11 ^②
		AWG 6	350 kcmil	—	—	✓	—	—	3VA9243-0JG12 ^②
		AWG 1	600 kcmil	—	—	—	✓	—	3VA9373-0JG13 ^①
		AWG 14	AWG 10	✓	—	—	—	—	3VA9134-0JG11
		AWG 14	1/0	—	✓	—	—	—	3VA9234-0JG11
	Aluminum body lug two cables (Cu/Al cable) kit of 3 single lugs	AWG 14	1/0	—	—	✓	—	—	3VA9144-0JG11 ^②
		AWG 14	1/0	—	✓	—	—	—	3VA9234-0JG12
		AWG 6	350 kcmil	—	—	✓	—	—	3VA9244-0JG12 ^②
		AWG 1	600 kcmil	—	—	—	✓	—	3VA9374-0JG13 ^①
		4/0	600 kcmil	—	—	—	—	✓	3VA9573-0JB23
	Aluminum body lug two cables (Cu/Al cable) kit of 4 single lugs	4/0	600 kcmil	—	—	—	—	✓	3VA9574-0JB23

①This conductor is ampere-rated at 380A with copper wire and 310A with aluminum wire.



②Meets requirements of 100% rated breakers up to 150A.

Molded Case Circuit Breakers

3VA Connection Technology

Selection

Aluminum Wire Connectors (cont.)

	Type	Minimum cable cross-section (standard) Class B	Maximum cable cross-section (standard) Class B	For molded case circuit breakers/ rated current					Part Number
				3VA5 125A	3VA5 250A	3VA6 150A 250A	3VA5 3VA6 400A 600A	3VA5 3VA6 800A 1000A	
 <p>3 lug kit pictured</p>	Aluminum body lug two cables with control wire tap (Cu/Al cable) kit of 3 single lugs	4/0	600 kcmil	—	—	—	—	✓	3VA9673-0JG23
	Aluminum body lug two cables with control wire tap (Cu/Al cable) kit of 4 single lugs	4/0	600 kcmil	—	—	—	—	✓	3VA9674-0JG23
	Aluminum body lug three cables (Cu/Al cable) kit of 3 single lugs	4/0	400 kcmil	—	—	—	—	✓	3VA9673-0JB32
	Aluminum body lug three cables (Cu/Al cable) kit of 4 single lugs	4/0	400 kcmil	—	—	—	—	✓	3VA9674-0JB32
 <p>4 lug kit pictured</p>	Aluminum body lug three cables with control wire tap (Cu/Al cable) kit of 3 single lugs	4/0	400 kcmil	—	—	—	—	✓	3VA9673-0JG32
	Aluminum body lug three cables with control wire tap (Cu/Al cable) kit of 4 single lugs	4/0	400 kcmil	—	—	—	—	✓	3VA9674-0JG32

5

MOLDED CASE CIRCUIT BREAKERS

Aluminum Wire Connectors and Terminal Covers

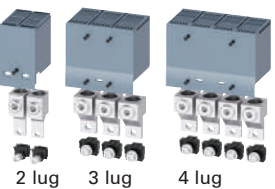
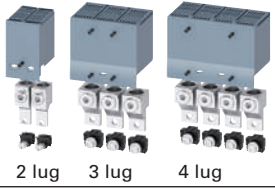
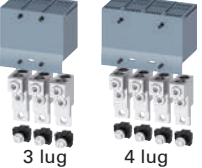
Type	Description	Min. cable cross-section (std.) Class B	Max. cable cross-section (std.) Class B	For molded case circuit breakers/ rated current					Part Number	Terminal Cover with Probe Holes Part Number
				3VA5 125A	3VA5 250A	3VA6 150A 250A	3VA5 3VA6 400A 600A	3VA5 3VA6 800A 1000A		
 <p>2 lug 3 lug 4 lug</p>	Kit of 2 single lugs and 1 extended terminal cover	AWG 4	300 kcmil	✓	—	—	—	—	3VA9132-0JJ12	
	Kit of 3 single lugs and 1 extended terminal cover	AWG 4	300 kcmil	✓	—	—	—	—	3VA9133-0JJ12	
		AWG 2	350 kcmil	—	✓	—	—	—	3VA9233-0JJ13	
	Kit of 4 single lugs and 1 extended terminal cover	AWG 2	350 kcmil	—	—	✓	—	—	3VA9243-0JJ13 [Ⓢ]	
		AWG 4	300 kcmil	✓	—	—	—	—	3VA9134-0JJ12	
		AWG 2	350 kcmil	—	✓	—	—	—	3VA9234-0JJ13	
 <p>2 lug 3 lug 4 lug</p>	Kit of 2 single lugs and 1 extended terminal cover	AWG 4	300 kcmil	✓	—	—	—	3VA9132-0JC12		
	Kit of 3 single lugs and 1 extended terminal cover	AWG 4	300 kcmil	✓	—	—	—	—	3VA9133-0JC12	3VA9133-0JC18
		AWG 2	350 kcmil	—	✓	—	—	—	3VA9233-0JC13	3VA9233-0JC18
		AWG 2	350 kcmil	—	—	✓	—	—	3VA9243-0JC13 [Ⓢ]	3VA9243-0JC18
	Kit of 4 single lugs and 1 extended terminal cover	AWG 4	300 kcmil	✓	—	—	—	—	3VA9134-0JC12	
		AWG 2	350 kcmil	—	✓	—	—	—	3VA9234-0JC13	
 <p>3 lug 4 lug</p>	Kit of 3 single lugs and 1 extended terminal cover	AWG 4	300 kcmil	—	✓	—	—	—	3VA9233-0JJ22	
		AWG 4	300 kcmil	—	—	✓	—	—	3VA9243-0JJ22 [Ⓢ]	
		2/0	600 kcmil	—	—	—	✓	—	3VA9473-0JJ23	
	Kit of 4 single lugs and 1 extended terminal cover	AWG 4	300 kcmil	—	—	✓	—	—	3VA9234-0JJ22	
		AWG 4	300 kcmil	—	✓	—	—	—	3VA9244-0JJ22 [Ⓢ]	
		2/0	600 kcmil	—	—	—	✓	—	3VA9474-0JJ23	







Ⓢ Meets requirements of 100% rated breakers up to 250A.

Molded Case Circuit Breakers

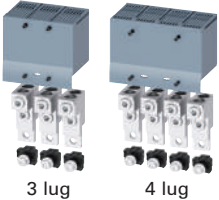
3VA Connection Technology

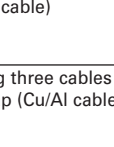
Selection

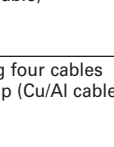
Aluminum Wire Connectors and Terminal Covers (cont.)

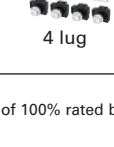
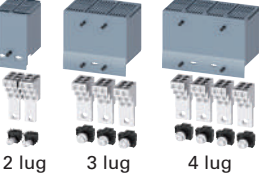
Type	Description	Min. cable cross-section (std.) Class B	Max. cable cross-section (std.) Class B	For molded case circuit breakers/ rated current					Part Number	Terminal Cover with Probe Holes Part Number	
				3VA5 125A	3VA5 250A	3VA6 150A 250A	3VA5 400A 600A	3VA6 800A 1000A			
Aluminum body lug, 2 Cables with control wire tap (Cu/Al cable)  3 lug 4 lug	Kit of 3 single lugs and 1 extended terminal cover	AWG 4	300 kcmil	—	✓	—	—	—	3VA9233-0JC22	3VA9233-0JC28	
		AWG 4	300 kcmil	—	—	✓	—	—	3VA9243-0JC22 ^①	3VA9243-0JC28	
		2/0	600 kcmil	—	—	—	✓	—	3VA9473-0JC23	3VA9473-0JC28	
	Kit of 4 single lugs and 1 extended terminal cover	AWG 4	300 kcmil	—	✓	—	—	—	3VA9234-0JC22		
		AWG 4	300 kcmil	—	—	✓	—	—	3VA9244-0JC22 ^①		
		2/0	600 kcmil	—	—	—	✓	—	3VA9474-0JC23		
Aluminum body lug two cables (Cu/Al cable) 3 lug kit pictured 	Kit of 3 single lugs and 1 extended terminal cover	400 kcmil	750 kcmil	—	—	—	—	✓	3VA9673-0JJ24		
	Kit of 4 single lugs and 1 extended terminal cover	400 kcmil	750 kcmil	—	—	—	—	✓	3VA9674-0JJ24		
Aluminum body lug two cables with control wire tap (Cu/Al cable) 3 kit lug pictured 	Kit of 3 single lugs and 1 extended terminal cover	400 kcmil	750 kcmil	—	—	—	—	✓	3VA9673-0JC24		
	Kit of 4 single lugs and 1 extended terminal cover	400 kcmil	750 kcmil	—	—	—	—	✓	3VA9674-0JC24		
Aluminum body lug three cables (Cu/Al cable) Kit of 3 lugs pictured 	Kit of 3 single lugs and 1 extended terminal cover	500 kcmil	750 kcmil	—	—	—	—	✓	3VA9673-0JJ34		
	Kit of 4 single lugs and 1 extended terminal cover	500 kcmil	750 kcmil	—	—	—	—	✓	3VA9674-0JJ34		
Aluminum body lug three cables with control wire tap (Cu/Al cable) Kit of 3 lugs pictured 	Kit of 3 single lugs and 1 extended terminal cover	500 kcmil	750 kcmil	—	—	—	—	✓	3VA9673-0JC34		
	Kit of 4 single lugs and 1 extended terminal cover	500 kcmil	750 kcmil	—	—	—	—	✓	3VA9674-0JC34		
Aluminum body lug four cables (Cu/Al cable) 4 lug kit pictured 	Kit of 3 single lugs and 1 extended terminal cover	4/0	500 kcmil	—	—	—	—	✓	3VA9673-0JJ43		
	Kit of 4 single lugs and 1 extended terminal cover	4/0	500 kcmil	—	—	—	—	✓	3VA9674-0JJ43		
Aluminum body lug four cables with control wire tap (Cu/Al cable) 4 lug kit pictured 	Kit of 3 single lugs and 1 extended terminal cover	4/0	500 kcmil	—	—	—	—	✓	3VA9673-0JC43		
	Kit of 4 single lugs and 1 extended terminal cover	4/0	500 kcmil	—	—	—	—	✓	3VA9674-0JC43		
Aluminum body lug four cables (Cu/Al cable) Kit of 4 lugs pictured 	Kit of 3 single lugs and 1 extended terminal cover	4/0	600 kcmil	—	—	—	—	✓	3VA9673-0JJ44		
	Kit of 4 single lugs and 1 extended terminal cover	4/0	600 kcmil	—	—	—	—	✓	3VA9674-0JJ44		
Aluminum body lug four cables with control wire tap (Cu/Al cable) Kit of 4 lugs pictured 	Kit of 3 single lugs and 1 extended terminal cover	4/0	600 kcmil	—	—	—	—	✓	3VA9673-0JC44		
	Kit of 4 single lugs and 1 extended terminal cover	4/0	600 kcmil	—	—	—	—	✓	3VA9674-0JC44		
Distribution lug, 6 Cables (Cu/Al cable)  2 lug 3 lug 4 lug	Kit of 2 single lugs and 1 extended terminal cover	AWG 14	AWG 2	✓	—	—	—	—	3VA9132-0JF60		
	Kit of 3 single lugs and 1 extended terminal cover	AWG 14	AWG 2	✓	—	—	—	—	—	3VA9133-0JF60	3VA9133-0JF68
		AWG 2	—	✓	—	—	—	—	—	3VA9233-0JF60	3VA9233-0JF68
		AWG 2	—	—	✓	—	—	—	—	3VA9243-0JF60 ^②	3VA9243-0JF68
		AWG 2	—	—	—	✓	—	—	—	3VA9373-0JF60 ^③	3VA9373-0JF68
	Kit of 4 single lugs and 1 extended terminal cover	AWG 14	AWG 2	✓	—	—	—	—	—	3VA9134-0JF60	
		AWG 2	—	✓	—	—	—	—	—	3VA9234-0JF60	
		AWG 2	—	—	✓	—	—	—	—	3VA9244-0JF60 ^②	
AWG 2		—	—	—	✓	—	—	—	3VA9374-0JF60 ^③		

① Meets requirements of 100% rated breakers up to 250A.

② Meets requirements of 100% rated breakers up to 100A.







③ Meets requirements of 100% rated breakers up to 100A.

Molded Case Circuit Breakers

3VA Connection Technology

Selection

Copper Wire Connectors



	Type	Minimum cable cross-section (standard) Class B	Maximum cable cross-section (standard) Class B	For molded case circuit breakers/ rated current					Part Number
				3VA5 125A	3VA5 250A	3VA6 150A 250A	3VA5 3VA6 400A 600A	3VA5 3VA6 800A 1000A	
	Copper body lug, small (Cu cable only) Kit of 3 single lugs	AWG 14	AWG 10	✓	—	—	—	—	3VA9133-0JD10
	Copper body lug (Cu cable only) Kit of 3 single lugs	AWG 14	2/0	✓	—	—	—	—	3VA9133-0JD11
		AWG 14	1/0	—	✓	—	—	—	3VA9233-0JD11
		AWG 6	350 kcmil	—	✓	—	—	—	3VA9233-0JD12
		AWG 14	1/0	—	—	✓	—	—	3VA9143-0JD11
		AWG 6	350 kcmil	—	—	✓	—	—	3VA9243-0JD12
	Copper body lug, small (Cu cable only) Kit of 4 single lugs	AWG 14	AWG 10	✓	—	—	—	—	3VA9134-0JD10
		AWG 14	AWG 10	✓	—	—	—	—	3VA9134-0JD10
	Copper body lug (Cu cable only) kit of 4 single lugs	AWG 14	AWG 10	✓	—	—	—	—	3VA9134-0JD11
		AWG 14	1/0	—	✓	—	—	—	3VA9234-0JD11
		AWG 14	1/0	—	—	✓	—	—	3VA9144-0JD11
		AWG 6	350 kcmil	—	✓	—	—	—	3VA9234-0JD12
		AWG 6	350 kcmil	—	—	✓	—	—	3VA9244-0JD12
	Copper body lug, three cables (Cu cable) Kit of 3 single lugs	4/0	400 kcmil	—	—	—	—	✓	3VA9673-0JD32
		4/0	400 kcmil	—	—	—	—	✓	3VA9674-0JD32
		AWG 14	AWG 10	✓	—	—	—	—	3VA9133-0JK10
		AWG 14	2/0	✓	—	—	—	—	3VA9133-0JK11
		AWG 14	1/0	—	✓	—	—	—	3VA9233-0JK11
	Copper body lug with control wire tap (Cu cable only) Kit of 3 single lugs	AWG 6	350 kcmil	—	✓	—	—	—	3VA9233-0JK12
		AWG 14	1/0	—	—	✓	—	—	3VA9143-0JK11
		AWG 6	350 kcmil	—	—	✓	—	—	3VA9243-0JK12
		AWG 1	600 kcmil	—	—	—	✓	—	3VA9373-0JK13
		AWG 14	AWG 10	✓	—	—	—	—	3VA9134-0JK10
	Copper body lug, small with control wire tap (Cu cable only) Kit of 4 single lugs	AWG 14	AWG 10	✓	—	—	—	—	3VA9134-0JK11
		AWG 14	1/0	—	✓	—	—	—	3VA9234-0JK11
		AWG 14	1/0	—	—	✓	—	—	3VA9144-0JK11
		AWG 6	350 kcmil	—	✓	—	—	—	3VA9234-0JK12
		AWG 6	350 kcmil	—	—	✓	—	—	3VA9244-0JK12
		AWG 1	600 kcmil	—	—	—	✓	—	3VA9374-0JK13
		400 kcmil	600 kcmil	—	—	—	—	✓	3VA9673-0JK32
		400 kcmil	600 kcmil	—	—	—	—	✓	3VA9674-0JK32
		400 kcmil	600 kcmil	—	—	—	—	✓	3VA9673-0JK32
		400 kcmil	600 kcmil	—	—	—	—	✓	3VA9674-0JK32

Molded Case Circuit Breakers



3VA Connection Technology

Selection

Copper Wire Connectors (cont.)

	Type	Minimum cable cross-section (standard) Class B	Maximum cable cross-section (standard) Class B	For molded case circuit breakers/ rated current					Part Number
				3VA5 125A	3VA5 250A	3VA6 150A 250A	3VA5 3VA6 400A 600A	3VA5 3VA6 800A 1000A	
	Copper body lug, 2 Cables (Cu cable only) Kit of 3 single lugs and 1 extended terminal cover	2/0	600 kcmil	—	—	—	✓	—	3VA9473-0JE23
	Copper body lug 2 Cables (Cu cable only) Kit of 4 single lugs and 1 extended terminal cover	2/0	600 kcmil	—	—	—	✓	—	3VA9474-0JE23
	Copper body lug, four cables (Cu cable) Kit of 3 single lugs and 1 extended terminal cover	4/0	500 kcmil	—	—	—	—	✓	3VA9673-0JE43
	Copper body lug, four cables (Cu cable) Kit of 4 single lugs and 1 extended terminal cover	4/0	500 kcmil	—	—	—	—	✓	3VA9674-0JE43
	Copper body lug, four cables (Cu cable) Kit of 3 single lugs and 1 extended terminal cover	4/0	500 kcmil	—	—	—	—	✓	3VA9673-0JL43
	Copper body lug, four cables (Cu cable) Kit of 4 single lugs and 1 extended terminal cover	4/0	500 kcmil	—	—	—	—	✓	3VA9674-0JL43

Nut Keeper Kits

	Type	Maximum terminal width	Maximum terminal thickness	For molded case circuit breakers/ rated current					Part Number
				3VA5 125A	3VA5 250A	3VA6 150A 250A	3VA5 3VA6 400A 600A	3VA5 3VA6 800A 1000A	
	Nut keeper kit kit of 3 single lugs	17 mm / 0.7 inch	6.5 mm / 0.25 inch	✓	—	—	—	—	3VA9133-0QA00
		25 mm / 1 inch	8 mm / 0.3 inch	—	✓	—	—	—	3VA9233-0QA00
		25 mm / 1 inch	8 mm / 0.3 inch	—	—	✓	—	—	3VA9243-0QA00
		35 mm / 1.4 inch	10 mm / 0.4 inch	—	—	—	✓	—	3VA9473-0QA00
	Nut keeper kit kit of 4 single lugs	17 mm / 0.7 inch	6.5 mm / 0.25 inch	✓	—	—	—	—	3VA9134-0QA00
		25 mm / 1 inch	8 mm / 0.3 inch	—	✓	—	—	—	3VA9234-0QA00
		25 mm / 1 inch	8 mm / 0.3 inch	—	—	✓	—	—	3VA9244-0QA00
		35 mm / 1.4 inch	10 mm / 0.4 inch	—	—	—	✓	—	3VA9474-0QA00
 4 lug kit pictured	Nut keeper kit kit of 3 single lug and terminal covers	50 mm / 2.0 inch	30 mm / 1.18 inch	—	—	—	—	✓	3VA9673-0QA00
	Nut keeper kit kit of 4 single lug and terminal covers	50 mm / 2.0 inch	30 mm / 1.18 inch	—	—	—	—	✓	3VA9674-0QA00







5
MOLDED CASE
CIRCUIT BREAKERS

Molded Case Circuit Breakers

3VA Connection Technology

Selection

Bus Connector Extensions





	Type	Maximum terminal width	Maximum terminal thickness	For molded case circuit breakers/ rated current					Part Number
				3VA5 125A	3VA5 250A	3VA6 150A 250A	3VA5 3VA6 400A 600A	3VA5 3VA6 800A 1000A	
	Front bus connectors extended 1 single connector	22 mm / 0.9 inch	8 mm / 0.3 inch	✓	—	—	—	—	3VA9131-0QB00
	Front bus connectors extended kit of 3 single connectors, 2 phase barriers, and 1 insulating plate	22 mm / 0.9 inch	8 mm / 0.3 inch	✓	—	—	—	—	3VA9133-0QB00
	Front bus connectors extended kit of 4 single connectors, 3 phase barriers, and 1 insulating plate	22 mm / 0.9 inch	8 mm / 0.3 inch	✓	—	—	—	—	3VA9133-0QB00
	Front bus connectors extended kit of 3 single connectors and 1 insulating plate	32 mm / 1.3 inch	10 mm / 0.4 inch	—	✓	✓	—	—	3VA9273-0QB00
		40 mm / 1.6 inch	12.5 mm / 0.5 inch	—	—	—	✓	—	3VA9473-0QB00
		50.8 mm / 2.0 inch	30 mm / 1.18 inch	—	—	—	—	✓	3VA9673-0QB00
	Front bus connectors extended kit of 4 single connectors and 1 insulating plate	32 mm / 1.3 inch	10 mm / 0.4 inch	—	—	✓	—	—	3VA9274-0QB00
		40 mm / 1.6 inch	12.5 mm / 0.5 inch	—	—	—	✓	—	3VA9474-0QB00
		50.8 mm / 2.0 inch	30 mm / 1.18 inch	—	—	—	—	✓	3VA9674-0QB00
	Front bus connectors offset kit of 3 single connectors 1 insulating plate Distance between pole centers: 400/600 A = 70 mm / 2.76 inches	60 mm / 2.4 inch	12.5 mm / 0.5 inch	—	—	—	✓	—	3VA9473-0QC00
		80 mm / 3.15 inch	30 mm / 1.18 inch	—	—	—	—	✓	3VA9673-0QC00
	Front bus connectors offset kit of 4 single connectors 1 insulating plate Distance between pole centers: 400/600 A = 70 mm / 2.76 inches	60 mm / 2.4 inch	12.5 mm / 0.5 inch	—	—	—	✓	—	3VA9474-0QC00
		80 mm / 3.15 inch	30 mm / 1.18 inch	—	—	—	—	✓	3VA9674-0QC00

Molded Case Circuit Breakers





3VA Connection Technology

Selection

Rear connection studs flat

	Type	For molded case circuit breakers/ rated current					Part Number
		3VA5 125A	3VA5 250A	3VA6 150A 250A	3VA5 3VA6 400A 600A	3VA5 3VA6 800A 1000A	
	Rear connection studs flat kit of 2 short flat studs and 1 long flat stud	✓	—	—	—	—	3VA9133-0QE00
		—	✓	—	—	—	3VA9233-0QE00
		—	—	✓	—	—	3VA9243-0QE00
		—	—	—	✓	—	3VA9473-0QE00
		—	—	—	—	✓	3VA9673-0QE00
	Rear connection studs flat kit of 2 short flat studs and 2 long flat studs	✓	—	—	—	—	3VA9134-0QE00
		—	✓	—	—	—	3VA9234-0QE00
		—	—	✓	—	—	3VA9244-0QE00
		—	—	—	✓	—	3VA9474-0QE00
		—	—	—	—	✓	3VA9674-0QE00
	Rear connection studs flat 1 short flat stud	✓	—	—	—	—	3VA9131-0QE10
		—	✓	—	—	—	3VA9231-0QE10
		—	—	✓	—	—	3VA9241-0QE10
		—	—	—	✓	—	3VA9471-0QE10
	Rear connection studs flat 1 long flat stud	✓	—	—	—	—	3VA9131-0QE20
		—	✓	—	—	—	3VA9231-0QE20
		—	—	✓	—	—	3VA9241-0QE20
		—	—	—	✓	—	3VA9471-0QE20

Rear connection studs round

	Rear connection studs round kit of 1 long round stud and 2 short round studs	✓	—	—	—	—	3VA9133-0QF00
		—	✓	—	—	—	3VA9233-0QF00
		—	—	✓	—	—	3VA9243-0QF00
		—	—	—	✓	—	3VA9473-0QF00
	Rear connection studs round kit of 2 long round studs and 2 short round studs	✓	—	—	—	—	3VA9134-0QF00
		—	✓	—	—	—	3VA9234-0QF00
		—	—	✓	—	—	3VA9244-0QF00
		—	—	—	✓	—	3VA9474-0QF00
	Rear connection studs round 1 short round studs	✓	—	—	—	—	3VA9131-0QF10
		—	✓	—	—	—	3VA9231-0QF10
		—	—	✓	—	—	3VA9241-0QF10
		—	—	—	✓	—	3VA9471-0QF10
	Rear connection studs round 1 long round stud	✓	—	—	—	—	3VA9131-0QF20
		—	✓	—	—	—	3VA9231-0QF20
		—	—	✓	—	—	3VA9241-0QF20
		—	—	—	✓	—	3VA9471-0QF20

5









MOLDED CASE
CIRCUIT BREAKERS

Molded Case Circuit Breakers

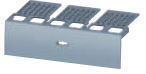
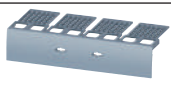
3VA Connection Technology

Selection

Phase barriers, terminal covers, and insulating plates







	Type	For molded case circuit breakers/ rated current					Part Number	Terminal Cover with Probe Holes Part Number	
		3VA5 125A	3VA5 250A	3VA6 150A 250A	3VA5 3VA6 400A 600A	3VA5 3VA6 800A 1000A			
	Phase barriers kit of 2 phase barriers	✓	–	–	–	–	3VA9132-0WA00		
		–	✓	✓	–	–	3VA9272-0WA00		
		–	–	–	✓	–	3VA9472-0WA00		
		–	–	–	–	✓	3VA9672-0WA00		
	Terminal cover for 1-pole breakers	✓	–	–	–	–	3VA9131-0WD10		
	Terminal cover for 2-pole breakers	✓	–	–	–	–	3VA9131-0WD20		
	Terminal cover for 3-pole breakers	✓	–	–	–	–	3VA9131-0WD30		3VA9131-0WD31
		–	✓	✓	–	–	3VA9271-0WD30		3VA9271-0WD31
		–	–	–	✓	–	3VA9471-0WD30		3VA9471-0WD31
	Terminal cover for 4-pole breakers	✓	–	–	–	–	3VA9131-0WD40		
		–	–	✓	–	–	3VA9271-0WD40		
		–	–	–	✓	–	3VA9471-0WD40		
		–	–	–	–	✓	3VA9671-0WD40		
		–	–	–	–	✓	3VA9671-0WE30		
		–	–	–	–	✓	3VA9671-0WE40		
	Terminal cover extended for 2-pole breakers	✓	–	–	–	–	3VA9131-0WF20		
	Terminal cover extended for 3-pole breakers	✓	–	–	–	–	3VA9131-0WF30		3VA9131-0WF31
		–	✓	✓	–	–	3VA9271-0WF30		3VA9271-0WF31
		–	–	–	✓	–	3VA9471-0WF30		3VA9471-0WF31
		–	–	–	–	✓	3VA9671-0WF30		
	Terminal cover extended for 4-pole breakers	✓	–	–	–	–	3VA9131-0WF40		
		–	✓	✓	–	–	3VA9271-0WF40		
		–	–	–	✓	–	3VA9471-0WF40		
		–	–	–	–	✓	3VA9671-0WF40		
	Terminal cover offset for 3-pole breakers	–	–	–	✓	–	3VA9471-0WG30		
	Terminal cover offset for 4-pole breakers	–	–	–	✓	–	3VA9471-0WG40		

Molded Case Circuit Breakers

3VA Connection Technology

Selection

Phase barriers, terminal covers, and insulating plates

	Type	For molded case circuit breakers / rated current				Part Number
		3VA5 125A	3VA5 250A	3VA6 150A 250A	3VA5 3VA6 400A 600A	
	Rear insulating plate extended for 2-pole breakers	✓	–	–	–	3VA9131-0WJ20
	Rear insulating plate extended for 3-pole breakers	✓	–	–	–	3VA9131-0WJ30
		–	✓	✓	–	3VA9271-0WJ30
		–	–	–	✓	3VA9471-0WJ30
	Rear insulating plate extended for 4-pole breakers	✓	–	–	–	3VA9131-0WJ40
		–	–	✓	–	3VA9271-0WJ40
		–	–	–	✓	3VA9471-0WJ40
	Rear insulating plate offset for 3-pole breakers	–	–	–	✓	3VA9471-0WK30
	Rear insulating plate offset for 4-pole breakers	–	–	–	✓	3VA9471-0WK40
	Control wire tap for busbar (for fixed mounting)	–	✓	✓	–	3VA9270-0WC00
		–	–	–	✓	3VA9470-0WC00

Molded Case Circuit Breakers



3VA Plug-in and Draw-out Technology

Selection

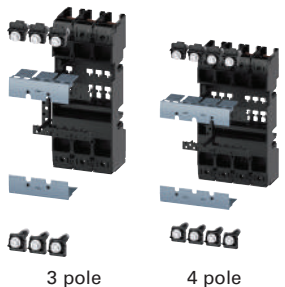
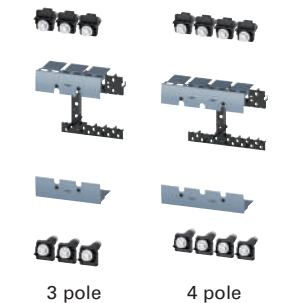
Plug-in socket

	Type	For molded case circuit breakers / rated current			Part Number
		3VA61/62 150A/250A	3VA63 400A	3VA64 600A	
 <p>3 pole 4 pole</p>	Plug-in unit, 3-pole, complete kit Consists of: Plug-in socket, Plug-in unit, conversion kit, Mounting screw kit	✓	—	—	3VA9143-0KP00
		—	✓	—	3VA9343-0KP00
		—	—	✓	3VA9443-0KP00
	Plug-in unit, 4-pole, complete kit Consists of: Plug-in socket, Plug-in unit, conversion kit, Mounting screw kit	✓	—	—	3VA9144-0KP00
		—	✓	—	3VA9344-0KP00
		—	—	✓	3VA9444-0KP00
 <p>3 pole 4 pole</p>	Plug-in unit, 3-pole, conversion kit Consists of: Screw-fastened terminal covers for molded case circuit breakers, Plug-in contacts, Cable cage, Autotrip plunger	✓	—	—	3VA9143-0KP10
		—	✓	✓	3VA9343-0KP10
	Plug-in unit, 4-pole, conversion kit Consists of: Screw-fastened terminal covers for molded case circuit breakers, Plug-in contacts, Cable cage, Autotrip plunger	✓	—	—	3VA9144-0KP10
		—	✓	✓	3VA9344-0KP10

Draw-out units

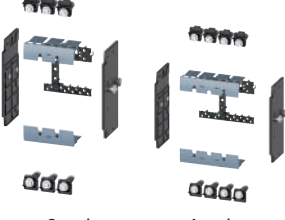
	Type	For molded case circuit breakers / rated current			Part Number
		3VA61/62 150A/250A	3VA63 400A	3VA64 600A	
 <p>ddd</p>	Draw-out unit, 3-pole, complete kit Consists of: Draw-out socket, Draw-out unit, conversion kit, Mounting screw kit	✓	—	—	3VA9143-0KD00
		—	✓	—	3VA9343-0KD00
		—	—	✓	3VA9443-0KD00
 <p>dddd</p>	Draw-out unit, 4-pole, complete kit Consists of: Draw-out socket, Draw-out unit, conversion kit, Mounting screw kit	✓	—	—	3VA9144-0KD00
		—	✓	—	3VA9344-0KD00
		—	—	✓	3VA9444-0KD00
 <p>3 pole 4 pole</p>	Draw-out unit, 3-pole, conversion kit Consists of: Screw-fastened terminal covers, Side wall, Plug-in contacts, Cable cage, Autotrip plunger	✓	—	—	3VA9143-0KD10
		—	✓	✓	3VA9343-0KD10
	Draw-out unit, 4-pole, conversion kit Consists of: Screw-fastened terminal covers, Side wall, Plug-in contacts, Cable cage, Autotrip plunger	✓	—	—	3VA9144-0KD10
		—	✓	✓	3VA9344-0KD10





Note: Crank handle for the drawout unit must be ordered separately.

Molded Case Circuit Breakers

3VA Plug-in and Draw-out Technology

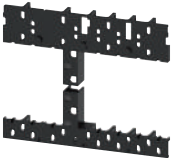
Selection

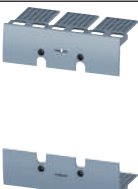
Accessories

	Type	For molded case circuit breakers / rated current		Part Number
		3VA61/62 150A/250A	3VA63/64 400A/600A	
		✓	—	3VA9167-0KB02
		—	✓	3VA9367-0KB02
	Door feedthrough	✓	—	3VA9147-0KT00
		—	✓	3VA9347-0KT00
	Autotrip plunger Plug-in unit	✓	—	3VA9267-0KP81
		—	✓	3VA9457-0KP81
	Autotrip plunger Draw-out unit	✓	—	3VA9267-0KD81
		—	✓	3VA9457-0KD81
	Terminal cover for plug-in/draw-out unit, 3-pole (spare part) To provide circuit breaker touch protection, for mounting on the molded case circuit breaker	✓	—	3VA9143-0KB01
		—	✓	3VA9343-0KB01
	Terminal cover for plug-in/draw-out unit, 4-pole (spare part) To provide circuit breaker touch protection, for mounting on the molded case circuit breaker	✓	—	3VA9144-0KB01
		—	✓	3VA9344-0KB01
	Crank handle for draw-out unit Insulated, including crank holder			3VA9987-0KD81

Molded Case Circuit Breakers

3VA Plug-in and Draw-out Technology

Selection

Other Accessories

	Type	Part Number
	Communication link for draw-out unit Consists of: Cable kit with 3 special position signaling switches, connecting cable 3VA9987-0KC10	3VA9977-0KC00
	Position signaling switches For draw-out unit	3VA9977-0KB00
	Spare connecting cable To connect the position signaling switches for communication with the COM060	3VA9987-0KC10
	Auxiliary circuit connector ■ For draw-out units	3VA9977-0KD80
	Auxiliary circuit connector ■ For plug-in units	3VA9977-0KP80
	Cylinder lock (type Ronis) ■ Includes a lock with 2 keys ■ For locking ■ For installation in all rotary operators with shaft stub ■ For mounting in the adapter kit for the accessories component	3VA9980-0VL10
		3VA9980-0VL30
		3VA9980-0VL40
	Cylinder lock adapter for draw-out unit ■ For fitting a cylinder lock in the right-hand side wall of the draw-out unit ■ To prevent unauthorized withdrawal or insertion of the circuit breaker; ■ Circuit breaker can be locked in the CONNECT, TEST, or DISCONNECT position	3VA9970-0LF40

Molded Case Circuit Breakers

3VA Communication and Testing/Commissioning Devices

Selection

Communications overview

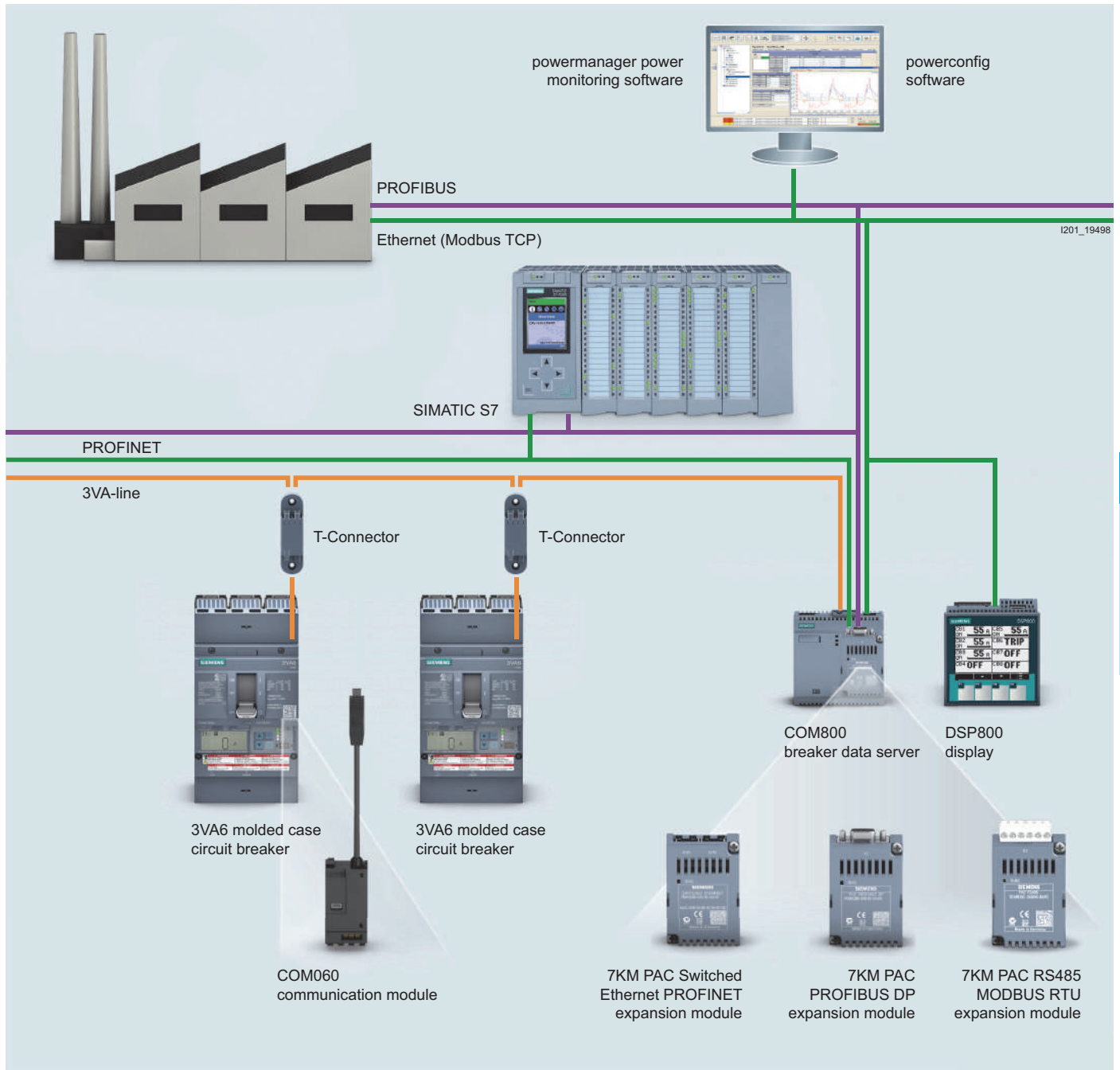





Molded Case Circuit Breakers





3VA Communication and Testing/Commissioning Devices

Selection

Modules

	Type	For molded case circuit breakers / rated current		Part Number
		3VA61/62 150A/250 A	3VA63/64/65/66 400A/600A 800A/1000A	
	24 V Module <ul style="list-style-type: none"> 24 V DC For mounting in the right-hand accessories compartment of the 3VA6 Optional energy supply for the ETU, also includes continuous operation of the ETU display and the metering function of the ETU 8-series 	✓	—	3VA9177-0TB50
		—	✓	3VA9377-0TB50
	COM060 communication module <ul style="list-style-type: none"> For mounting in the right-hand accessories compartment of the 3VA6 molded case circuit breaker (including ETU power supply) Communication with the COM800/COM100 breaker data server via the 3VA-line Including a T-Connector 	✓	—	3VA9177-0TB10
		—	✓	3VA9377-0TB10
	Spare SLC adapter COM060, 24 V module accessory for: <ul style="list-style-type: none"> 3VA61/62 100/150/250 	✓	—	3VA9187-0TB60
	Spare SLC adapter COM060, 24 V module accessory for: <ul style="list-style-type: none"> 3VA63/64 400/600 	—	✓	3VA9387-0TB60

Breaker data server









	Type	Part Number
	COM800 breaker data server <ul style="list-style-type: none"> 2 terminating resistors Central communication module for connecting up to eight 3VA6 molded case circuit breakers via the 3VA-line Ethernet 10/100 Mbit/s interface Module slot for plugging on an optional PROFIBUS DP, PROFINET or RS485 module 	3VA9977-0TA10
	COM100 breaker data server <ul style="list-style-type: none"> 2 terminating resistors Central communication module for connecting one 3VA6 molded case circuit breaker Ethernet 10/100 Mbit/s interface Module slot for plugging on an optional PROFIBUS DP, PROFINET or RS485 module 	3VA9977-0TA20
	7KM PAC PROFIBUS DP expansion module <ul style="list-style-type: none"> The 7KM PAC PROFIBUS DP expansion module is used for connecting the COM800/COM100 breaker data server, and the 3VA molded case circuit breakers connected to it, to PROFIBUS DPV1 The 7KM PAC PROFIBUS DP expansion module provides the status and measured quantities of the 3VA molded case circuit breaker for the PROFIBUS DP master. It receives information (e.g. commands) from the PROFIBUS DP master, and forwards this information to the 3VA molded case circuit breaker 	7KM9300-0AB01-0AA0
	7KM PAC Switched Ethernet PROFINET expansion module <ul style="list-style-type: none"> The 7KM PAC Switched Ethernet PROFINET expansion module is used to connect the COM800/COM100 breaker data server, and the connected 3VA molded case circuit breaker, to PROFINET via two Ethernet interfaces The 7KM PAC Switched Ethernet PROFINET expansion module provides the status and measured quantities of the 3VA molded case circuit breaker to PROFINET via the PROFINET IO, PROFinenergy and Modbus TCP protocols 	7KM9300-0AE01-0AA0
	7KM PAC RS485 Modbus RTU expansion module <ul style="list-style-type: none"> The 7KM PAC RS485 Modbus expansion module is used to connect the COM800/COM100 breaker data server, and the 3VA molded case circuit breaker connected to it, to Modbus RTU The 7KM PAC RS485 Modbus expansion module provides the status and measured quantities of the 3VA molded case circuit breaker for the Modbus RTU master. It receives information (e.g. commands) from the Modbus RTU master, and forwards this information to the 3VA molded case circuit breaker 	7KM9300-0AM00-0AA0

Molded Case Circuit Breakers

3VA Communication and Testing/Commissioning Devices

Selection

Accessories for Communication





	Type	Part Number
	T-Connector <ul style="list-style-type: none"> Spare part Provides spur line feeder to COM060 and loops to the next circuit breaker Includes a connection adapter for mounting on the 3VA6 breaker enclosure 	3VA9987-0TG10
	DIN rail adapter For snapping the T-Connector onto a DIN rail	3VA9987-0TG11
	Preassembled T-Connector-to-T-Connector or T-Connector-to-COM800/ COM100 connecting cable <ul style="list-style-type: none"> 0.4 m long 	3VA9987-0TC10
	<ul style="list-style-type: none"> 1 m long 	3VA9987-0TC20
	<ul style="list-style-type: none"> 2 m long 	3VA9987-0TC30
	<ul style="list-style-type: none"> 4 m long 	3VA9987-0TC40
	Preassembled connecting cable for extending the COM060-to-T-Connector spur line connection <ul style="list-style-type: none"> 0.4 m long 	3VA9987-0TF20
	<ul style="list-style-type: none"> 0.8 m long 	3VA9987-0TF10
	Additional bus terminating resistors	3VA9987-0TE10
	Voltage tap to external N conductor Cable for connecting the neutral point for the metering function of the 8-Series ETU, length 1.5 m	3VA9987-0UC10
	External current transformer as straight-through transformer. Connection of an external current transformer for the N conductor for 3-pole 3VA6 molded case circuit breakers for 5-series and 8-series ETUs (ETU850, ETU856, ETU860), including connecting cable <ul style="list-style-type: none"> In = 25 ... 150A 	3VA9077-0NA10
	<ul style="list-style-type: none"> In = 160 ... 350 A 	3VA9177-0NA10
	<ul style="list-style-type: none"> In = 400 ... 630 A 	3VA9377-0NA10
	<ul style="list-style-type: none"> In = 600 ... 1000 A 	3VA9677-0NA10
	DSP800 display <ul style="list-style-type: none"> For displaying the status, measured values and parameters of up to 8 3VA6 molded cases circuit breakers Connection to the COM800/COM100 via Ethernet for displaying information of the COM800/COM100 and the connected 3VA6 molded case circuit breaker 	3VA9977-0TD10
	EFB300 <ul style="list-style-type: none"> External function box for connection to the ETU of the 3VA6 molded case circuit breaker 4 digital outputs for information output, 1 digital input ZSI functionality S0 interface Including cable 1.5 m in length 	3VA9977-0UA10
	Connecting cable for EFB300 and MMB300. Spare part <ul style="list-style-type: none"> 1.5 m long 	3VA9987-0UB10
	<ul style="list-style-type: none"> 3.0 m long 	3VA9987-0UB20
	<ul style="list-style-type: none"> 3.0 m long for 3VA with EFB and RCD820 	3VA9987-0UB30

Molded Case Circuit Breakers

3VA Communication and Testing/Commissioning Devices

Selection

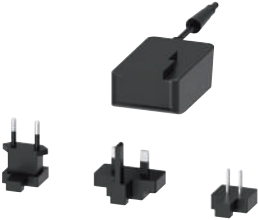
Test devices

	Type	Part Number
	<p>TD300</p> <ul style="list-style-type: none"> ■ Connection to the front interface of the ETU ■ Test device for activating the ETU and triggering a test trip 	<p>3VA9977-0MA10</p>
	<p>TD500</p> <ul style="list-style-type: none"> ■ Connection to the front interface of the ETU ■ Initiation of various test trips (LSING) ■ USB interface for connection of a PC using powerconfig ■ ETU parameterization ■ Including external power supply unit with adapter for Europe, UL and GB ■ Including connecting cable to the 3VA6 molded case circuit breaker 	<p>3VA9977-0MB10</p>
	<p>Spare part: External power supply for TD500 110 ... 240 V AC</p>	<p>3VA9987-0MX10</p>
	<p>Spare part: Cable for connecting to the TD500 to the 3VA6 molded case circuit breaker</p>	<p>3VA9977-0MY10</p>

Maintenance Mode Box









	<p>MMB300</p> <ul style="list-style-type: none"> ■ Realization of the NEC 240.87 (Arc Energy Reduction) -> personal protection during maintenance work ■ Switch into maintenance mode by changing the I- and G-protection to the lowest possible value through an external signal (e.g. door contact) ■ Available for all 3VA6 circuit breakers with electronic trip unit ■ Daisy chain up to 8 circuit breakers equipped with MMB300 ■ Additional digital output (D01) for ETU signals available ■ Capable of DIN rail mounting ■ Includes cable 1.5m in length 	<p>3VA9977-0UF10</p>
---	--	----------------------

Molded Case Circuit Breakers

3VA Accessories and Spare Parts

Selection

Locking, Blocking, & Interlocking

	Type	For molded case circuit breakers/ rated current						Part Number	
		3VA4 125A	3VA5 125A	3VA5 250A	3VA6 150A 250A	3VA5 3VA6 400A 600A	3VA5 3VA6 800A 1000A		
	Blocking device for the handle	-	✓	-	-	-	-	3VA9038-0LB10	
		-	-	✓	✓	✓	-	3VA9378-0LB10	
 3VA5/3VA6 3VA4	Padlock device for the handle	✓	-	-	-	-	-	3VA9038-0LB11	
		-	-	✓	✓	-	-	3VA9138-0LB11	
		-	-	-	-	✓	-	3VA9338-0LB11	
		-	-	-	-	-	✓	3VA9578-0LB10	
	Adapter kit for mounting the cylinder lock (type Ronis) in the accessories compartment of the molded case circuit breaker. Comprising 2 cylinder lock casings (one for locking and one for interlocking) and the appropriate mounting module <ul style="list-style-type: none"> To implement an interlock or a lock: select suitable cylinder lock(s) For an interlock: select the same cylinder lock number 	-	✓	-	-	-	-	3VA9137-0LF10	
		-	-	✓	-	-	-	-	3VA9237-0LF10
		-	-	-	✓	-	-	-	3VA9147-0LF10
		-	-	-	-	✓	-	-	3VA9347-0LF10
		-	-	-	-	-	✓	-	3VA9577-0LF10
	Cylinder lock (type Ronis) <ul style="list-style-type: none"> Includes a lock with 2 keys For locking or interlocking For installation in all rotary operators with shaft stub For mounting in the adapter kit for the accessories compartment 	-	✓	✓	✓	✓	-	3VA9980-0VL10	
		-	✓	✓	✓	✓	-	3VA9980-0VL30	
		-	✓	✓	✓	✓	-	3VA9980-0VL40	
		-	✓	✓	✓	✓	-	3VA9980-0VL40	
	Sliding bar Complete kit for interlocking 2 circuit breakers <ul style="list-style-type: none"> The article number must be ordered 2X to implement an interlock between 3 breakers of the same size 	-	✓	-	-	-	-	3VA9138-0VF30	
		-	-	✓	-	-	-	3VA9238-0VF30	
		-	-	-	✓	-	-	3VA9148-0VF30	
		-	-	-	-	✓	-	3VA9348-0VF30	
	Module for handle interlock using a bowden cable <ul style="list-style-type: none"> A separate handle interlock module is required for each switching device A Bowden cable must be ordered separately 	-	✓	-	-	-	-	3VA9137-0VF10	
		-	-	✓	-	-	-	3VA9237-0VF10	
		-	-	-	✓	-	-	3VA9147-0VF10	
		-	-	-	-	✓	-	3VA9347-0VF10	
		-	-	-	-	-	✓	3VA9577-0VF10	
	Rear interlock with rod Complete Kit <ul style="list-style-type: none"> Mounting frames are not included in scope of supply 	-	✓	✓	✓	✓	-	3VA9078-0VM10	
	Rear interlock with rod Complete Kit <ul style="list-style-type: none"> Mounting frames are included in scope of supply 	-	-	-	-	-	✓	3VA9578-0VM10	
	Rear interlock with rod Complete Kit for plug-in/draw-out unit <ul style="list-style-type: none"> Mounting frames are not included in scope of supply 	-	✓	✓	✓	✓	-	3VA9078-0VM30	



5
MOLDED CASE
CIRCUIT BREAKERS

Molded Case Circuit Breakers



3VA Accessories for Locking, Blocking and Interlocking

Selection

Locking, Blocking, & Interlocking

	Type	For molded case circuit breakers/ rated current					Part Number
		3VA5 125A	3VA5 250A	3VA6 150A 250A	3VA5 3VA6 400A 600A	3VA5 3VA6 800A 1000A	
	Bowden cable						
	▪ Length 0.6 m	✓	✓	✓	✓	—	3VA9980-0VC10
	▪ Length 1.0 m	✓	✓	✓	✓	—	3VA9980-0VC20
	▪ Length 1.5 m	✓	✓	✓	✓	—	3VA9980-0VC30
	Mounting frame for rear interlock with rod ^{①②} The following are required for the complete mounting frame kit:						
	▪ Profile poles	✓	✓	✓	✓	—	3VA9078-0VK10
	▪ Mounting Plates	✓	—	—	—	—	3VA9138-0VK20
		—	✓	—	—	—	3VA9238-0VK20
		—	—	✓	—	—	3VA9248-0VK20
		—	—	—	✓	—	3VA9448-0VK20

Cover frame for door cut-out

	Cover frame for door cut-out for molded case circuit breaker ▪ 3-pole, door cut-out without trip unit	✓	—	—	—	—	3VA9033-0SB10
		—	✓	✓	—	—	3VA9143-0SB10
		—	—	—	✓	—	3VA9373-0SB10
		—	—	—	—	✓	3VA9583-0SB10
	Cover frame for door cut-out for molded case circuit breaker ▪ 3-pole, door cut-out with trip unit	✓	—	—	—	—	3VA9033-0SB20
		—	✓	—	—	—	3VA9233-0SB20
		—	—	✓	—	—	3VA9143-0SB20
		—	—	—	✓	—	3VA9343-0SB20
		—	—	—	—	✓	3VA9583-0SB20
	Cover frame for door cut-out for molded case circuit breaker ▪ 4-pole, door cut-out without trip unit	✓	—	—	—	—	3VA9034-0SB10
		—	✓	✓	—	—	3VA9144-0SB10
		—	—	—	✓	—	3VA9374-0SB10
		—	—	—	—	✓	3VA9584-0SB10
		—	—	—	—	—	3VA9034-0SB20
	Cover frame for door cut-out for molded case circuit breaker ▪ 4-pole, door cut-out with trip unit	✓	—	—	—	—	3VA9034-0SB20
		—	✓	—	—	—	3VA9234-0SB20
		—	—	✓	—	—	3VA9144-0SB20
		—	—	—	✓	—	3VA9344-0SB20
		—	—	—	—	✓	3VA9584-0SB20
Cover frame for door cut-out for MO320 motor operators	✓	—	—	—	—	3VA9033-0SB10	
	—	✓	✓	—	—	3VA9237-0SB30	
	—	—	—	✓	—	3VA9377-0SB30	
Cover frame for door cut-out for front mounted rotary operators	✓	—	—	—	—	3VA9033-0SB10	
	—	✓	✓	—	—	3VA9143-0SB10	
	—	—	—	✓	—	3VA9373-0SB10	
Cover frame for door cut-out for front mounted rotary operator with door interlock	—	—	—	✓	—	3VA9377-0SB30	
	—	—	—	—	✓	3VA9583-0SB50	
Cover frame for door cut-out for door feedthrough	—	✓	✓	—	—	3VA9233-0SB20	
	—	—	—	✓	—	3VA9333-0SB20	
	Labeling plate for cover frame						3VA9087-0SX10

① 2 mounting plates are required. They are screwed onto the profile rail that can be ordered above. Different breakers can be mutually interlocked.

② Breakers with plug-in unit can be mounted on the mounting plates, but the profile rails cannot be used.

Molded Case Circuit Breakers

3VA Accessories and Spare Parts

Selection

Other accessories

	Type	For molded case circuit breakers/ rated current					Part Number
		3VA5 125A	3VA5 250A	3VA6 150A 250A	3VA5 3VA6 400A 600A	3VA5 3VA6 800A 1000A	
	Busbar adapter system with 60 mm busbar center-to-center spacing 3-pole	✓	—	—	—	—	8US1211-4SS00 ^①
		—	✓	✓	—	—	8US1213-4AP03 ^②
		—	—	—	✓	—	8US1213-4AH04 ^②
	Busbar adapter system with 60 mm busbar center to center spacing, bottom connection, 3-pole Busbar adapter designed for 3VA breaker used as a main	✓	—	—	—	—	8US1215-4SS00
		—	—	—	—	—	—
	Metric mounting screw kit For fixed mounted breakers 1-pole	✓	—	—	—	—	3VA9151-0SS10
	Metric mounting screw kit (2 pcs) For fixed mounted breakers 2-pole	✓	—	—	—	—	3VA9116-0SS10
	Metric mounting screw kit (4 pcs) For fixed mounted breakers 3-,4-pole	✓	✓	—	—	—	3VA9114-0SS10
	Metric mounting screw kit For fixed mounted breakers 3-pole	—	—	✓	—	—	3VA9126-0SS10
	Metric mounting screw kit For fixed mounted breakers 4-pole	—	—	✓	—	—	3VA9124-0SS10
	Metric mounting screw kit For fixed mounted breakers 3-,4-pole	—	—	—	✓	—	3VA9328-0SS10
	Metric mounting screw kit For plug-in and draw-out unit	—	—	✓	—	—	3VA9124-0SS10
	SAE mounting screw kit (2 pcs) For fixed mounted breakers 1-pole	✓	—	—	—	—	3VA9151-0SS00
	SAE Mounting screw kit (2 pcs) For fixed mounted breakers 2-,3-pole	✓	—	—	—	—	3VA9156-0SS00
	SAE Mounting screw kit (4 pcs) For fixed mounting breakers 4-pole	✓	—	—	—	—	3VA9154-0SS00
	SAE Mounting screw kit (4 pcs) For fixed mounted breakers 3-,4-pole and 3VA6 150/250 plug-in and draw-out units	—	✓	✓	—	—	3VA9164-0SS00
	SAE Mounting screw kit (2 pcs) For fixed mounted breakers 2-,3-pole	—	✓	✓	—	—	3VA9166-0SS00
	SAE Mounting screw kit (4 pcs) For fixed mounted breakers 2-,3-,4-pole and 3VA6 400/600 plug-in and draw-out units	—	—	—	✓	—	3VA9368-0SS00
	Replacement handle extension accessory	—	—	—	✓	—	3VA9487-0SC10

① Busbar adapter designed for 3VA breaker used as a feeder.



② Busbar adapter designed for 3VA breaker used as either a main or feeder.

Molded Case Circuit Breakers

3VA Accessory Electrical Requirements

Technical data

Auxiliary switches electrical requirements

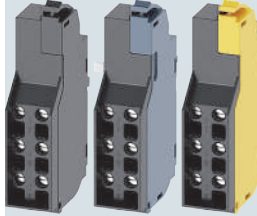
		Auxiliary switches and alarm switches HQ				Auxiliary switches and alarm switches HQ_electronic				Auxiliary switches and alarm switches HP		
												
		AUX	LCS	TAS	EAS	AUX	LCS	TAS	EAS	AUX	LCS	TAS
Rated operational voltage	U_e	V AC 50 Hz	240			24				600		
		V DC	250			24				250		
Conventional free-air thermal current	$I_{th} = I_e$	A	6			0.3				10		
IEC Ratings Listed	AC-12	12 V	A	6		0.3				10		
		24 V	A	6		0.3				10		
		48 V	A	6		--				10		
		125 V	A	6		--				10		
		220/240 V	A	6		--				10		
		380/440 V	A	--			--			6		
	600 V	A	--			--			2			
	AC-15	12 V	A	3		0.3				6		
		2/4 V	A	3		0.3				6		
		48 V	A	3		--				6		
		125 V	A	3		--				6		
		220/240 V	A	3		--				6		
		380/440 V	A	--			--			2		
	600 V	A	--			--			0.6			
	DC-12	12 V	A	6		0.1				6		
24 V		A	4		0.1				6			
48 V		A	2		--				2			
110 V		A	0.5		--				0.6			
250 V		A	0.25		--				0.3			
DC-13	12 V	A	1		0.07				3			
	24 V	A	0.8		0.07				3			
	48 V	A	0.4		--				0.8			
	110 V	A	0.2		--				0.2			
	250 V	A	0.1		--				0.1			
Max. rated current (UL/CSA)	Inductive load (0.75-0.8 AC)	24 V	A	3		0.3				6		
		300 V	A	3		--				6		
		600 V	A	--		--				6		
	Pilot duty (AC)	24 V	A	3		--				6		
		127 V	A	3		--				6		
		240 V	A	3		--				3		
		480 V	A	--		--				1.5		
		600 V	A	--		--				1.2		
	Resistive load (DC)	24 V	A	0.25		0.1				0.3		
		250 V	A	0.25		--				0.3		
	Resistive load - pilot duty sequence (DC)	125 V	A	0.6		--				0.9		
		250 V	A	0.3		--				0.55		
Minimum load	At 24 V DC	mA	70		0.5				70			
	At 5 V DC	mA	--		1				--			

Molded Case Circuit Breakers

3VA Accessory Electrical Requirements

Technical data

Shunt trip/undervoltage electrical requirements





				Shunt trip left STL	Shunt trip flexible STF	Undervoltage releases UVR	Universal release UNI
Power consumption U_e	12	V DC	W	50	--	--	--
	24	50 V AC/60 Hz	VA	50	--	--	--
	24 ... 30	V DC	W	7 ... 50	--	--	--
	48 ... 60	50 V AC/60 Hz	VA	15 ... 20	--	--	--
	48 ... 60	V DC	W	20 ... 30	--	--	--
	110 ... 127	50 V AC/60 Hz	VA	30 ... 40	--	--	--
	110 ... 127	V DC	W	30 ... 40	--	--	--
	208 ... 277	50 V AC/60 Hz	VA	16 ... 35	--	--	--
	220 ... 250	V DC	W	28 ... 35	--	--	--
	380 ... 600	50 V AC/60 Hz	VA	10 ... 30	--	--	--
	24	50 V AC/60 Hz	VA	--	300	--	--
	48 ... 60	50 V AC/60 Hz	VA	--	340 ... 600	--	--
	110 ... 127	50 V AC/60 Hz	VA	--	500 ... 650	--	--
	208 ... 277	50 V AC/60 Hz	VA	--	360 ... 650	--	--
	380 ... 500	50 V AC/60 Hz	VA	--	330 ... 600	--	--
	600	50 V AC/60 Hz	VA	--	300	--	--
	12	V DC	W	--	--	< 2.5	--
	24	V DC	W	--	--	< 2.5	--
	48	V DC	W	--	--	< 2.5	--
	60	V DC	W	--	--	< 2.5	--
	125 ... 127	V DC	W	--	--	< 2.5	--
	220 ... 230	V DC	W	--	--	< 2.5	--
	250	V DC	W	--	--	< 2.5	--
	24	50 V AC/60 Hz	VA	--	--	< 2	--
	48	50 V AC/60 Hz	VA	--	--	< 2	--
	60	50 V AC/60 Hz	VA	--	--	< 2	--
	110	50 V AC/60 Hz	VA	--	--	< 2	--
120 ... 127	50 V AC/60 Hz	VA	--	--	< 2	--	
208 ... 230	50 V AC/60 Hz	VA	--	--	< 2	--	
380 ... 400	50 V AC/60 Hz	VA	--	--	< 2.5	--	
440 ... 480	50 V AC/60 Hz	VA	--	--	< 2.5	--	
12	V DC (Cat II; PELV/SELV)	W	--	--	--	UVR: < 2.5 SHT: 20	
24	V DC (Cat II; PELV/SELV)	W	--	--	--	UVR: < 2.5 SHT: 20	
48	V DC (Cat II; PELV/SELV)	W	--	--	--	UVR: < 2.5 SHT: 20	

Molded Case Circuit Breakers

3VA Accessory Electrical Requirements

Technical data

Shunt trip/undervoltage electrical requirements

				Shunt trip left STL	Shunt trip flexible STF	Undervoltage releases UVR	Universal release UNI
							
Rated impulse withstand voltage	U_{imp}	kV	6			4	0.5
Making current	I_{max}	at V	1.5 A/24 V AC	18 A/24 V AC	5 mA/480 V	1.5 A/24 V	
Maximum tripping time		ms	< 10				
Service life	Electrical trips		8500				
	Mechanical switching cycles of the circuit breaker		25000				
Priority over other control signals			Given				
Degree of protection	Lid of the accessories compartment closed		IP40				
	Lid of the accessories compartment open		IP 20				
Minimum signal duration		ms	40	40	--	40	
Response voltage shunt trip	Pick-up (circuit breaker trips)	Us/V	%	70 ... 110	--	--	70 ... 110
Undervoltage release response voltage	Pick-up (circuit breaker can be switched on)	Us/V	%	--	--	85 ... 110	
	Pick-up (circuit breaker trips)	Us/V	%	--	--	35 ... 70	
Tripping frequency	Trips per hour		Unlimited	120	Unlimited		
Can be used for electrical interlocking of molded case circuit breakers			No	No	Yes		

Motor operator electrical requirements

MO320 motor operator	3VA5 125 A	3VA5 250 A	3VA6 150 A/ 250 A	3VA5 3VA6 400 A/ 600 A
Degree of protection	NEMA 1			
Rated control supply voltage (operating range of control supply voltage)	24 V ... 60 V DC (0.85 ... 1.26) 110 V ... 230 V AC/ 110 V ... 250 V DC (0.85 ... 1.1)			
Rating	250 W, max. 500 W (60 ms)			
Make time, typically	< 800 ms	< 1000 ms		< 1700 ms
Break time, typically	< 800 ms	< 1000 ms		< 1400 ms



Molded Case Circuit Breakers

ED 125A Frame Sentron Series

Selection

Ordering Instructions

- All ED Frame Sentron circuit breakers are supplied with load side lugs. If line side lugs are required, add "L" suffix to catalogue number. Consult Siemens sales office for any additional charge.
- 50°C Calibration, 400HZ - see page 5-150. All ED frame circuit breakers may be reverse connected.

Type ED2^⑤

Blue Label

Continuous Current Rating @ 40°C	1-Pole		2-Pole		3-Pole
	120V AC	125V DC	240V AC	125V DC 250V DC	240V AC
	Catalogue Number		Catalogue Number		Catalogue Number
15	ED21B015 ^④		—		ED23B015
20	ED21B020 ^④		ED22B020		ED23B020
25	ED21B025		ED22B025		ED23B025
30	ED21B030		ED22B030		ED23B030
35	ED21B035		ED22B035		ED23B035
40	ED21B040		ED22B040		ED23B040
45	ED21B045		ED22B045		ED23B045
50	ED21B050		ED22B050		ED23B050
60	ED21B060		ED22B060		ED23B060
70	ED21B070		ED22B070		ED23B070
80	ED21B080		ED22B080		ED23B080
90	ED21B090		ED22B090		ED23B090
100	ED21B100		ED22B100		ED23B100

Shipping Weights

Number of Poles	Number per Carton	Shipping Weight (lbs.)
ED2, ED4, ED6, HED4		
1	30	38
2	10	25
3	10	38
CED6		
2	5	20
3	5	30

Lugs

Ampere Rating	No. of Poles	Catalogue Number	Wire Range
Aluminum Body Lugs			
All 15–25A	1, 2, 3	Line/Load SA1E025	#14–#10 Cu #12–#10 Al
All 30–100A	1, 2, 3	Line Side LN1E100	#10–1/0 Cu/Al
ED2, 4, CED6 30–60A	1	Load Side LD1E060	#10–#4 Cu/Al
ED2, 4, CED6 70–100A	1	Load Side LD1E100	#6–#1/0 Cu/Al
ED2, 4, 6, HED4 30–100A	2, 3	Load Side LN1E100	#10–1/0 Cu/Al
All 110, 125A	2, 3	Line/Load TA1E6125	#3–3/0 Cu #1–2/0 Al
Copper Body Lugs			
All 30–125A only	1, 2, 3	Line/Load TC1ED6150 ^③	#10–1/0 Cu
Compression Lugs			
All ED, CED		CCE125	2/0

Type ED4^⑤

Blue Label

Continuous Current Rating @ 40°C	1-Pole		2-Pole		3-Pole
	120V AC	125V DC	480V AC	250V DC	480V AC
	Catalogue Number		Catalogue Number		Catalogue Number
15	ED41B015 ^④		—		ED43B015
20	ED41B020 ^④		ED42B020		ED43B020
25	ED41B025		ED42B025		ED43B025
30	ED41B030		ED42B030		ED43B030
35	ED41B035		ED42B035		ED43B035
40	ED41B040		ED42B040		ED43B040
45	ED41B045		ED42B045		ED43B045
50	ED41B050		ED42B050		ED43B050
60	ED41B060		ED42B060		ED43B060
70	ED41B070		ED42B070		ED43B070
80	ED41B080		ED42B080		ED43B080
90	ED41B090		ED42B090		ED43B090
100	ED41B100		ED42B100		ED43B100
110	—		ED42B110		ED43B110
125	—		ED42B125		ED43B125

Type ED6^⑤

Blue Label

Continuous Current Rating @ 40°C	1-Pole		2-Pole		3-Pole	
	347V AC		600V AC	250V DC	600V AC	500V DC
	Catalogue Number		Catalogue Number		Catalogue Number	
15	ED61B015		—		ED63B015	
20	ED61B020		ED62B020		ED63B020	
25	ED61B025		ED62B025		ED63B025	
30	ED61B030		ED62B030		ED63B030	
35	ED61B035		ED62B035		ED63B035	
40	ED61B040		ED62B040		ED63B040	
45	ED61B045		ED62B045		ED63B045	
50	ED61B050		ED62B050		ED63B050	
60	ED61B060		—		ED63B060	
70	ED61B070		—		ED63B070	
80	ED61B080		—		ED63B080	
90	ED61B090		—		ED63B090	
100	ED61B100		—		ED63B100	
110	—		—		ED63B110	
125	—		—		ED63B125	

Note: ED frame circuit breakers qualified to UL 489 Supplement SB "Naval" — See page 5-137 for additional information

①CSA Certified only (Not UL)

②For CED types and all 110–125 ampere ED frames.

③See **Note: A**, page 5-150.

④SWD rated.
⑤HACR rated.

Modifications page 5-147
Accessories page 5-151 - 5-159

Molded Case Circuit Breakers

ED 125A Frame Sentron Series

Selection

Type HED4[®]

Black Label

Continuous Current Rating @ 40°C	1-Pole		2-Pole		3-Pole
	277V AC	125V DC	480V AC	250V DC	480V AC
	Catalogue Number		Catalogue Number		Catalogue Number
15	HED41B015 ^①		HED42B015		HED43B015
20	HED41B020 ^①		HED42B020		HED43B020
25	HED41B025		HED42B025		HED43B025
30	HED41B030		HED42B030		HED43B030
35	HED41B035		HED42B035		HED43B035
40	HED41B040		HED42B040		HED43B040
45	HED41B045		HED42B045		HED43B045
50	HED41B050		HED42B050		HED43B050
60	HED41B060		HED42B060		HED43B060
70	HED41B070		HED42B070		HED43B070
80	HED41B080		HED42B080		HED43B080
90	HED41B090		HED42B090		HED43B090
100	HED41B100		HED42B100		HED43B100
110	—		HED42B110		HED43B110
125	—		HED42B125		HED43B125

Fuseless Current Limiting

Type CED6

Red Label

Continuous Current Rating @ 40°C	2-Pole		3-Pole
	600V AC, 250V DC		600V AC, 500V DC ^②
	Catalogue Number		Catalogue Number
15	—		CED63B015
20	CED62B020		CED63B020
25	—		—
30	CED62B030		CED63B030
35	—		—
40	CED62B040		CED63B040
45	—		—
50	CED62B050		CED63B050
60	CED62B060		CED63B060
70	CED62B070		CED63B070
80	CED62B080		CED63B080
90	CED62B090		CED63B090
100	CED62B100		CED63B100
110	—		CED63B110
125	CED62B125		CED63B125

FIGURE 1 - ED, HED, HHED

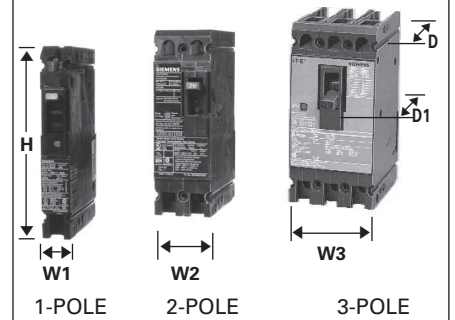
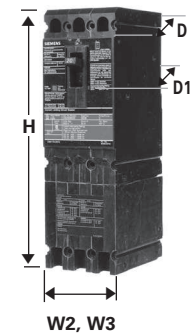

FIGURE 2 - CED (3-Pole shown)



Dimensions (in inches)

Breaker Type	W1	W2	W3	H	D	D1
Figure 1 ED2, ED4, ED6, HED4, ED6 ETI	1	2	3	6.35	3.92	4.56
Figure 2 CED6, CED6 ETI	—	2	3	9.58	3.92	4.56

Interrupting Ratings

Breaker Type	CSA C22.2 No.5-02 / UL 489 AIR (File #E10848)									IEC 947-2					
	RMS Symmetrical Amperes (KA)														
	Volts AC						Volts DC			220/240		380/415		500	
	120	240	277	347	480	600	125	250	500 ^②	Icu	Ics	Icu	Ics	Icu	Ics
ED2 (1-P)	10	—	—	—	—	—	5	—	—	—	—	—	—	—	—
ED2 (2, 3-P)	—	10	—	—	—	—	—	5 (2-P)	—	—	—	—	—	—	—
ED4 (1-P)	65	—	22	—	— 18	—	30	—	—	—	—	—	—	—	—
ED4 (2, 3-P)	—	65	—	—	—	—	—	30 (2-P)	—	—	—	—	—	—	—
ED6 (1P)	—	—	—	30 ^③	— 25	—	—	—	—	—	—	—	—	—	—
ED6 (2, 3-P)	—	65	—	—	—	18	—	30 (2-P)	18 (3-P)	65	17	35	9	18	5
HED4 (1-P)	100	—	65	—	—	—	30	—	—	—	—	—	—	—	—
(15-30A)	100	— 100	25	—	—	—	30	—	—	—	—	—	—	—	—
HED4 (1-P)	—	—	—	—	42	—	—	30 (2-P)	—	—	—	—	—	—	—
(35-100A)	—	—	—	—	—	—	—	—	—	—	—	—	—	—	—
HED4 (2, 3-P) ^③	—	—	—	—	—	—	—	—	—	—	—	—	—	—	—
CED6 (2, 3-P)	—	200	—	—	200	100	—	30 (2-P)	50 (3-P)	—	—	—	—	—	—

①SWD rated.

②When wired as shown on page 5-4, this circuit breaker is CSA Certified / UL listed and rated for use on 500V DC ungrounded UPS systems.

③HED4 type circuit breakers meet the CSA / UL criteria for "current limiting" at 240V AC.

④ED6-ETI, CED6-ETI, see page 5-101 for ordering information.

⑤Single Pole 15-30A 30KA @ 347V CSA only. 35-100A 18KA @ 347V CSA only.

⑥HACR rated.

Molded Case Circuit Breakers

Accessories

Selection

Accessories for:

ED 125A Frame

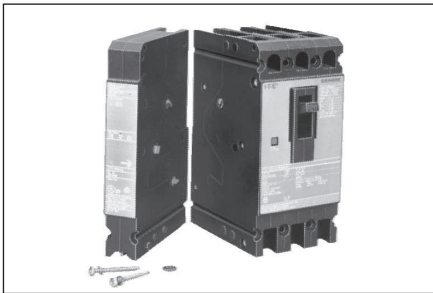

Combinations

Available only when ordered together.

Only one module can be added to a breaker. Additional accessories, which always attach to the left pole, cannot be added to the combination later. Adds 1 inch pole space.

Equipment Ground Sensing

A field addable kit containing 30mA or 5 mA ground fault accessory module, current transformer with 24 inch leads, and current transformer mounting equipment. Current transformer to mount in gutter of lighting panel or any control panel. **Accessory module operates from separate 120V control power source.**

Both 30MA and 5MA devices are equipment protection devices only. **Do not use for personnel protection.**



Shunt Trip Combinations

Control Voltage		1 Shunt Trip	1 Shunt Trip and 1 Auxiliary Switch	1 Shunt Trip 1 Auxiliary Switch and 1 Alarm Switch	1 Shunt Trip and 1 Alarm Switch	1 Shunt Trip and 2 Auxiliary Switches
AC	DC	Catalogue Number	Catalogue Number	Catalogue Number	Catalogue Number	Catalogue Number
24	—	S17ED60	—	—	—	—
48	—	S18ED60	—	—	—	—
120	—	S01ED60	S01ED62A	S01ED62AB	S01ED62B	S01ED62AA
208	—	—	S02ED62A	S02ED62AB	S02ED62B	S02ED62AA
240	—	S03ED60	S03ED62A	S03ED62AB	S03ED62B	S03ED62AA
277	—	S15ED60	S15ED64A	S15ED64AB	S15ED64B	—
480	—	S04ED60	S04ED64A	S04ED64AB	S04ED64B	—
—	12	S16ED60	S16ED62A	—	—	—
—	24	S07ED60	S07ED62A	S07ED62AB	S07ED62B	S07ED62AA
—	48	S09ED60	S09ED62A	S09ED62AB	S09ED62B	S09ED62AA
—	125	S11ED60	S11ED62A	S11ED62AB	S11ED62B	S11ED62AA
—	250	S13ED60	S13ED62A	S13ED62AB	S13ED62B	S13ED62AA

Undervoltage Trip Combinations

Control Voltage		1 Undervoltage Trip	1 Undervoltage Trip and 1 Auxiliary Switch	1 Undervoltage Trip and 1 Auxiliary Switch and 1 Alarm Switch	1 Undervoltage Trip and 1 Alarm Switch"	1 Undervoltage Trip and 2 Auxiliary Switches
AC	DC	Catalogue Number	Catalogue Number	Catalogue Number	Catalogue Number	Catalogue Number
120	—	U01ED60	U01ED62A	U01ED62AB	U01ED62B	U01ED62AA
208	—	U02ED60	U02ED62A	U02ED62AB	U02ED62B	U02ED62AA
240	—	U03ED60	U03ED62A	U03ED62AB	U03ED62B	U03ED62AA
277	—	U16ED60	U16ED64A	U16ED64AB	U16ED64B	—
480	—	U06ED60	U06ED64A	U06ED64AB	U06ED64B	—
600	—	U08ED60	—	—	—	—
—	24	U13ED60	U13ED62A	U13ED62AB	U13ED62B	U13ED62AA
—	48	U14ED60	U14ED62A	U14ED62AB	U14ED62B	U14ED62AA
—	125	U10ED60	U10ED62A	U10ED62AB	U10ED62B	U10ED62AA
—	250	U12ED60	U12ED62A	—	—	U12ED62AA

Auxiliary and Alarm Switch Combinations

Maximum Voltage		1 Auxiliary Switch*	1 Alarm Switch	Alarm Switch and 1 Auxiliary Switch	2 Auxiliary Switches	1 Alarm Switch and 2 Auxiliary Switches
AC	DC	Catalogue Number	Catalogue Number	Catalogue Number	Catalogue Number	Catalogue Number
240	250	A01ED62	B00ED62	A01ED62B	A02ED62	A02ED62B
480	—	A01ED64	B00ED64	A01ED64B	—	—
—	12	A01EDLV*		Gold Plated Contacts—for PLC use		

Alarm Switch Only

Maximum Voltage		1 Alarm Switch
AC	DC	Catalogue Number
240	250	B00ED62
480	—	B00ED64

Ground Fault Sensing Relay Kit — Equipment Protection Only

For Use With Breaker Frame	Number of Poles	Description	Catalogue Number	
		30mA	30mA	5mA
ED2, ED4, ED6, HED4, CED6	1, 2, 3	Basic Kit	GF01ED60	GF01ED65
		Basic Kit with Normally Open Bell Alarm	GF01ED60B0	GF01ED65B0
		Basic Kit with Normally Closed Bell Alarm	GF01ED60BC	GF01ED65BC

Molded Case Circuit Breakers

FD 250A Frame Sentron Series

Selection

Type FXD6-A^{①⑦}

Blue Label

Non-Interchangeable Trip (Assembled Circuit Breaker – Without Lugs)

Continuous Current Rating @ 40°C	2-Pole ^②		3-Pole	
	Catalogue Number		Catalogue Number	
70	FXD62B070		FXD63B070	
80	FXD62B080		FXD63B080	
90	FXD62B090		FXD63B090	
100	FXD62B100		FXD63B100	
110	FXD62B110		FXD63B110	
125	FXD62B125		FXD63B125	
150	FXD62B150		FXD63B150	
175	FXD62B175		FXD63B175	
200	FXD62B200		FXD63B200	
225	FXD62B225		FXD63B225	
250	FXD62B250		FXD63B250	

Type FD6-A^⑦

Blue Label

Interchangeable Trip

Continuous Current Rating @ 40°C	Complete Breaker Unassembled with Lugs	Frame Only	Trip Unit Only
	Catalogue Number	Catalogue Number	Catalogue Number

2-Pole 600V AC, 250V DC^②

Continuous Current Rating @ 40°C	Catalogue Number	Frame Only Catalogue Number	Trip Unit Only Catalogue Number
70	FD62B070	FD62F250	FD62T070
80	FD62B080		FD62T080
90	FD62B090		FD62T090
100	FD62B100		FD62T100
110	FD62B110		FD62T110
125	FD62B125		FD62T125
150	FD62B150		FD62T150
175	FD62B175		FD62T175
200	FD62B200		FD62T200
225	FD62B225		FD62T225
250	FD62B250		FD62T250

3-Pole 600V AC, 500V DC^③

Continuous Current Rating @ 40°C	Catalogue Number	Frame Only Catalogue Number	Trip Unit Only Catalogue Number
70	FD63B070	FD63F250	FD63T070
80	FD63B080		FD63T080
90	FD63B090		FD63T090
100	FD63B100		FD63T100
110	FD63B110		FD63T110
125	FD63B125		FD63T125
150	FD63B150		FD63T150
175	FD63B175		FD63T175
200	FD63B200		FD63T200
225	FD63B225		FD63T225
250	FD63B250		FD63T250

Interrupting Ratings

Breaker Type	RMS Symmetrical Amperes (KA)										
	CSA / UL 489 AIR (File E10848)					IEC 947-2					
	Volts AC (50/60Hz)					Volts DC					
	240	480	600	250	500 ^③	220/240		380/415		500	
					Icu	Ics	Icu	Ics	Icu	Ics	
FXD6-A, FD6-A	65	35	22	30 (2-P)	18 (3-P)	65	33	35	9	20	10
HFXD6 ^④ , HFD6 ^④	100	65	25	30 (2-P)	25 (3-P)	100	50	65	33	42	21
HHFD6 ^④ , HHFXD6 ^④	200	100	25	—	—	200	100	100	50	65	33
CFD6	200	200	100	50 (2-P)	50 (3-P)	—	—	—	—	—	—

Instantaneous Adjustment Trip Range

Breaker Ampere Rating	Nominal Instantaneous Values							
	Low ^⑤	2	3	4	5	6	7	High ^⑥
70-90	600	640	690	730	770	810	850	900
100-110	700	770	840	920	990	1060	1140	1200
125-150	800	900	1000	1100	1200	1300	1400	1500
175-200	900	1060	1210	1370	1520	1780	1930	2000
225-250	1100	1300	1500	1700	1900	2100	2300	2500

Note: FD frame qualified to UL489 supplement SB "NAVAL". See page 5-137 for additional information.

Ordering Information

Complete Breaker Unassembled with Lugs

Prices of FD6, HFD6, and HHFD6 breakers includes frame, trip and both line and load lugs (TA1FD350A). When ordered by these catalogue numbers, the customer will receive the frame, trip, and lugs separately packaged. For applications requiring different lugs, order individual items as needed.

Complete Breaker Assembled without Lugs

Prices of FXD6, HFXD6, HHFXD6, and CFD6 includes frame with non-interchangeable trip unit installed only. Order required lugs separately. For line and load lugs (TA1FD350A) installed, add suffix "L" to catalogue number (add 2 times list price of lugs for each pole).

50°C Applications see page 5-137.

400 Hz Applications see page 5-137.

Lugs For 75°C Wire^④

Catalogue Number	Wire Range
TA1FD350A	#6–350 kcmil Cu
TC1FD350	#4–350 kcmil Al
	#6–350 kcmil Cu
Compression Lug	
CCF250	350 kcmil Cu/Al

① Type FXD6-A circuit breakers are CSA / UL Listed for reverse fed applications.

② 2-pole units are 3-pole width.

③ When wired as shown on page 5-4, this circuit breaker is CSA Certified / UL 489 listed and rated for use on 500V DC ungrounded UPS systems only.

④ See Note A, page 5-147.

⑤ HFD6 and HHFD6 type circuit breakers meet the UL criteria for "current limiting" at 240 and 480V AC.

⑥ HACR rated.

⑦ +/- 20% Tolerance.

Modifications page 5-150
Accessories page 5-151 - 5-159

Molded Case Circuit Breakers

FD 250A Frame Sentron Series

Type HFD6^⑤, Type HFXD6^{③④⑤⑥}

Black Label

Interchangeable Trip			
Continuous Current Rating @ 40°C	Complete Breaker Unassembled with Lugs	Frame Only	Trip Unit Only
	Catalogue Number	Catalogue Number	Catalogue Number
2-Pole 600V AC, 250V DC (3 Pole Width)			
70	HFD62B070	HFD62F250	FD62T070
80	HFD62B080		FD62T080
90	HFD62B090		FD62T090
100	HFD62B100		FD62T100
110	HFD62B110		FD62T110
125	HFD62B125		FD62T125
150	HFD62B150		FD62T150
175	HFD62B175		FD62T175
200	HFD62B200		FD62T200
225	HFD62B225		FD62T225
250	HFD62B250		FD62T250

3-Pole 600V AC, 500V DC^①			
70	HFD63B070	HFD63F250	FD63T070
80	HFD63B080		FD63T080
90	HFD63B090		FD63T090
100	HFD63B100		FD63T100
110	HFD63B110		FD63T110
125	HFD63B125		FD63T125
150	HFD63B150		FD63T150
175	HFD63B175		FD63T175
200	HFD63B200		FD63T200
225	HFD63B225		FD63T225
250	HFD63B250		FD63T250

Type HHFD^④, HHFXD6^{②③④⑥}

3-Pole 600V AC, Extra High Interrupting			
70	HHFD63B070	HHFD63F250	FD63T070
80	HHFD63B080		FD63T080
90	HHFD63B090		FD63T090
100	HHFD63B100		FD63T100
110	HHFD63B110		FD63T110
125	HHFD63B125		FD63T125
150	HHFD63B150		FD63T150
175	HHFD63B175		FD63T175
200	HHFD63B200		FD63T200
225	HHFD63B225		FD63T225
250	HHFD63B250		FD63T250

Type CFD6^{③⑥}

Red Label

Fuseless Current Limiting

Non-Interchangeable Trip (Assembled Circuit Breaker Without Lugs)	
Continuous Current Rating @ 40°C	3-Pole
	600V AC/500V DC
	Catalogue Number
70	CFD63B070
80	CFD63B080
90	CFD63B090
100	CFD63B100
110	CFD63B110
125	CFD63B125
150	CFD63B150
175	CFD63B175
200	CFD63B200
225	CFD63B225
250	CFD63B250

① When wired as shown on page 5-4, this circuit breaker is CSA Certified / UL listed and rated for use on 500V DC ungrounded UPS systems.

② For non-interchangeable trip 3-pole HFD6 type circuit breaker, change prefix identifier from HFD6 to HFXD6. Price equals frame and trip prices combined, e.g. price of HFXD63B250 equals price of HFD63F250 plus price of FD63T250. Order lugs separately.

③ Type HFXD6, HHFXD6, CFD6 are CSA Certified / UL Listed for reverse feed applications.

④ Type HFXD6, HFD6, HHFD6, HHFXD6 meet the CSA Certified / UL criteria for "Current Limiting" at 240 VAC and 480V AC.

⑤ FXD6, ETI, CFD6, ETI — See page 5-59 for ordering information.

⑥ HACR rated.

Selection/Dimensions

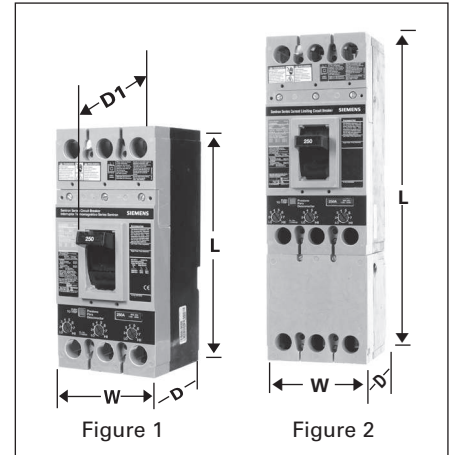

Dimensions (in inches)

Breaker Type	W	L	D	D1 (to handle)
Figure 1 FXD6-A, FD6-A, HFD6, HFXD6, HHFD6, FD6-ETI ^⑤	4.50	9.50	4	5.25
Figure 2 CFD6, CFD6-ETI ^⑥	4.50	14.25	4	5.25

Shipping Weights

Number of Poles	Number per Carton	Shipping Weight (lbs.)
FD6-A, HFD6, HHFD6, FXD6-A Assembled Circuit Breaker (less connectors)		
2	1	8.6
3	1	10
FD6-A, HFD6, HHFD6 Frame Only		
2	1	7.5
3	1	8.7
FD6 Trip Unit Only		
2	1	1.1
3	1	1.3
CFD6 Assembled Circuit Breaker (less terminals)		
2	1	31
3	1	34

Molded Case Circuit Breakers

Internal Accessories

Selection

Accessories:
FD 250A Frame



Shunt Trip Combinations

Control Voltage		1 Shunt Trip
AC	DC	Catalogue Number
24	—	S17FD60
120	—	S01FD60
240	—	S03FD60
277	—	S15FD60
480	—	S04FD60
600	—	S06FD60
—	12	S16FD60
—	24	S07FD60
—	48	S09FD60
—	125	S11FD60
—	250	S13FD60

Undervoltage Trip Combinations

Control Voltage		1 Undervoltage Trip	1 Undervoltage Trip and 1 Auxiliary Switch
AC	DC	Catalogue Number	Catalogue Number
120	—	U01FD60	W01FD64
208	—	U02FD60	W02FD64
240	—	U03FD60	W03FD64
277	—	U16FD60	W16FD64
480	—	U06FD60	W06FD64
600	—	U08FD60	W08FD64
—	24	U13FD60	W13FD64
—	48	U14FD60	W14FD64
—	125	U10FD60	W10FD64
—	250	U12FD60	W12FD64

Auxiliary Switch Combinations

Voltage		1 Auxiliary Switch	2 Auxiliary Switches
AC	DC	Catalogue Number	Catalogue Number
240	—	A01FD62	A02FD62
480	—	A01FD64	A02FD64
—	12	A01FDLV	Gold Plated Contacts - for PLC use

Alarm Switch Combinations

Maximum Voltage		1 Alarm Switch	1 Alarm Switch and 1 Auxiliary Switch
AC	DC	Catalogue Number	Catalogue Number
480	250	B00FD64	C01FD64

©Auxiliary switch application is for 480V AC maximum.
Note: Old F-frame accessories cannot be used in new Sentron line. Likewise, new FD-frame accessories cannot be used on old F-frame circuit breakers.

Molded Case Circuit Breakers

JD 400A Frame Sentron Series

Selection

Type JXD2-A^①

Blue Label

240V AC, 2-pole 250V DC only

Non-Interchangeable Trip (Assembled Circuit Breaker without Lugs)		
Continuous Current Rating @ 40°C	2-Pole (3 Pole Width)	
	Catalogue Number	3-Pole Catalogue Number
200	JXD22B200	JXD23B200
225	JXD22B225	JXD23B225
250	JXD22B250	JXD23B250
300	JXD22B300	JXD23B300
350	JXD22B350	JXD23B350
400	JXD22B400	JXD23B400

Type JXD6-A^{①⑤}

Blue Label

600V AC, 2-pole 250V DC, 3-pole 500V DC

Non-Interchangeable Trip (Assembled Circuit Breaker without Lugs)		
Continuous Current Rating @ 40°C	2-Pole (3 Pole Width)	
	Catalogue Number	3-Pole Catalogue Number
200	JXD62B200	JXD63B2003366.0
225	JXD62B225	JXD63B225
250	JXD62B250	JXD63B250
300	JXD62B300	JXD63B300
350	JXD62B350	JXD63B3503366.0
400	JXD62B400	JXD63B400

Type JD6-A^②

Blue Label

Interchangeable Trip			
Continuous Current Rating @ 40°C	Complete Breaker Unassembled with Lugs	Frame Only	Trip Unit Only
	Catalogue Number	Catalogue Number	Catalogue Number
200	JD62B200	JD62F400	JD62T200
225	JD62B225		JD62T225
250	JD62B250		JD62T250
300	JD62B300		JD62T300
350	JD62B350		JD62T350
400	JD62B400		JD62T400

2-Pole 600V AC, 250V DC (3 Pole Width)

200	JD62B200	JD62F400	JD62T200
225	JD62B225		JD62T225
250	JD62B250		JD62T250
300	JD62B300		JD62T300
350	JD62B350		JD62T350
400	JD62B400		JD62T400

3-Pole 600V AC, 500V DC^②

200	JD63B200	JD63F400	JD63T200
225	JD63B225		JD63T225
250	JD63B250		JD63T250
300	JD63B300		JD63T300
350	JD63B350		JD63T350
400	JD63B400		JD63T400

Interrupting Ratings

Breaker Type	RMS Symmetrical Amperes (KA)					IEC 947-2				
	CSA / UL 489 AIR (File E10848)					Volts AC (50/60Hz)				
	Volts AC (50/60Hz)					Volts DC				
	240	480	600	250	500 ^③	220/240		380/415		500
					lcu	lcs	lcu	lcs	lcu	lcs
JXD2-2	65	—	—	30 (2-P)	—	—	—	—	—	—
JXD6-2, JD6-A	65	35	25	30 (2-P)	25 (3-P)	65	33	40	20	30
HJD6-A, HJXD6-A	100	65	35	30 (2-P)	35 (3-P)	100	50	65	33	42
HHJD6-A, HJXD6 ^④	200	100	50	—	—	200	100	100	50	65
CJD6	200	150	100	50 (2-P)	50 (3-P)	—	—	—	—	—

Instantaneous Adjustment Trip Range

Breaker Ampere Rating	Nominal Instantaneous Values							
	Low ^⑤	2	3	4	5	6	7	High ^⑥
200-300	1250	1430	1610	1790	1960	2140	2320	2500
350-400	2000	2290	2570	2860	3140	3430	3710	4000

Ordering Information

Complete Breaker Unassembled with Lugs

Prices of JD6, HJD6, and HHJD6 breakers include frame, trip and both line and load lugs (TA2J6500). When ordered by these catalogue numbers, the customer will receive the frame, trip, and lugs separately packaged. For applications requiring different lugs, order individual items as needed.

Complete Breaker Assembled without Lugs

Prices of JXD6, HJXD6, HHJXD6, and CJD6 include frame with non-interchangeable trip unit installed only. Order required lugs separately. For line and load lugs (TA2J6500) installed, add suffix "L" to catalogue number (add 2 times list price of lugs for each pole).

100% Rated

Types JXD6 and HJXD6 breakers are available with 100% ratings. To order add suffix "H" to catalogue number, and 10% to list price.

100% rated JD breakers require the use of 90°C Cu cable and lugs TC1J6600 or TC2J6500.

50°C Applications see page 5-137.

400Hz Applications see page 5-137.

Lugs For 75°C Wire^⑦

Catalogue Number	Cables per Lug	Wire Range
TA2J6500	1, 2	#3/0-500 kcmil Cu #4/0-500 kcmil Al
TA1L6750	1	500-750 kcmil Al 500-600 kcmil Cu
TC1J6600	1	#3/0-600 kcmil Cu
TC2J6500	1, 2	#3/0-500 kcmil Cu
Compression Lug		
CCL600	1	500 kcmil Cu/Al

① Type JXD2 and JXD6 circuit breakers are CSA Certified / UL Listed for reverse feed applications.

② When wired as shown on page 5-4, this circuit breaker is CSA Certified / UL Listed and rated for use on 500V DC ungrounded UPS systems only.

③ See Note: A, page 5-147.

④ HHJD6 type circuit breakers meet the CSA / UL criteria for "current limiting" at 240 and 480V AC.

⑤ HACR rated.

⑥ +/- 20% Tolerance.

Note: JD frame qualified to UL489 supplement B

"NAVAL." See page 5-137 for additional information.

Modifications page 5-150
Accessories page 5-151 - 5-159

Molded Case Circuit Breakers

JD 400A Frame Sentron Series

Selection

Type HJD6-A, HJXD6-A^{②④⑥}

Black Label

Interchangeable Trip			
Continuous Current Rating @ 40°C	Complete Breaker Unassembled with Lugs	Frame Only	Trip Unit Only
	Catalogue Number	Catalogue Number	Catalogue Number
2-Pole 600V AC, 250V DC (3 Pole Width)			
200	HJD62B200	HJD62F400	JD62T200
225	HJD62B225		JD62T225
250	HJD62B250		JD62T250
300	HJD62B300		JD62T300
350	HJD62B350		JD62T350
400	HJD62B400		JD62T400

3-Pole 600V AC, 500V DC^{①②⑤}

200	HJD63B200	HJD63F400	JD63T200
225	HJD63B225		JD63T225
250	HJD63B250		JD63T250
300	HJD63B300		JD63T300
350	HJD63B350		JD63T350
400	HJD63B400		JD63T400

Type HHJD6, HHJXD6-A^{②④⑥}

2-Pole 600V AC (3 Pole Width)

200	HHJD62B200	HHJD62F400	JD62T200
225	HHJD62B225		JD62T225
250	HHJD62B250		JD62T250
300	HHJD62B300		JD62T300
350	HHJD62B350		JD62T350
400	HHJD62B400		JD62T400

3-Pole 600V AC

200	HHJD63B200	HHJD63F400	JD63T200
225	HHJD63B225		JD63T225
250	HHJD63B250		JD63T250
300	HHJD63B300		JD63T300
350	HHJD63B350		JD63T350
400	HHJD63B400		JD63T400

Type CJD6^⑥

Red Label

Fuseless Current Limiting

Non-Interchangeable Trip (Assembled Circuit Breaker Without Lugs)		
Continuous Current Rating @ 40°C	2-Pole	3-Pole
	600V AC/250V DC	600V AC/500V DC
		Catalogue Number
200	For 2-pole application use outside poles of 3-pole circuit breaker	CJD63B200
225		CJD63B225
250		CJD63B250
300		CJD63B300
350		CJD63B350
400		CJD63B400

For inches / millimeters conversion, see Technical section.

2-pole units available in 3-pole construction.

① When wired as shown on page 5-4, this circuit breaker is CSA Certified / UL Listed and rated for use on 500V DC ungrounded UPS systems only.

② For non-interchangeable 3-pole HJD6 or HHJD6 type circuit breaker change the prefix identifier to HJXD6 or HHJXD6. Order lugs separately.

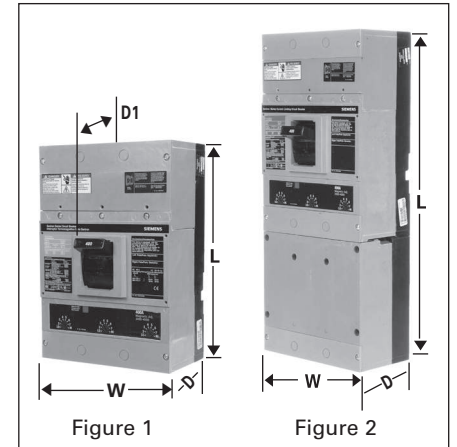

Dimensions (in inches)

Breaker Type	W	L	D	D1 (to handle)
Figure 1 JXD2-A, JXD6-A, JD6-A HJD6-A, HJXD6-A, HHJD6, HJD6, HJXD6, HHJXD6, JXD6-ETI ^③	7.5	11	4	5.44
Figure 2 CJD6, CJD6-ETI ^③	7.5	17.86	4	5.44

Shipping Weights

Number of Poles	Number per Carton	Shipping Weight (lbs.)
JXD2, JXD6, JD6, HJD6, HHJD6 Assembled Breaker (less terminals)		
2	1	17.5
3	1	19.5"
JD6, HJD6, HHJD6 Frame Only		
2	1	14
3	1	15.5
JD6 Trip Unit Only		
2	1	3.5
3	1	4
CJD6 Complete Assembled Breaker (less terminals)		
2	1	29.5
3	1	31.5

③ JXD6-ETI, CJD6-ETI see page 5-117 for ordering information.

④ Type HJXD6, HHJXD6 Circuit Breakers are CSA Certified / UL Listed for reverse fed applications.

⑤ CE applies to non-interchangeable type HJXD only.

⑥ HACR rated.

Molded Case Circuit Breakers

SJD 400A Frame Digital Solid State Sentron Sensitrip IV Series

Selection

Type SJD6-B

Blue Label

Type SHJD6-B

Black Label

Current Limiting

Type SCJD6-B

Red Label

Max Current Rating	3-Pole, 600V AC		3-Pole, 600V AC		3-Pole, 600V AC	
	Catalogue Number (Advanced trip unit) ^③	Catalogue Number (Basic trip unit)	Catalogue Number (Advanced trip unit) ^③	Catalogue Number (Basic trip unit)	Catalogue Number (Advanced trip unit) ^③	Catalogue Number (Basic trip unit)
200	SJD6A200LI	SJD6B200LI	SHJD6A200LI	SHJD6B200LI	SCJD6A200LI	SCJD6B200LI
300	SJD6A300LI	SJD6B300LI	SHJD6A300LI	SHJD6B300LI	SCJD6A300LI	SCJD6B300LI
400	SJD6A400LI	SJD6B400LI	SHJD6A400LI	SHJD6B400LI	SCJD6A400LI	SCJD6B400LI
200	SJD6A200LIG	SJD6B200LIG	SHJD6A200LIG	SHJD6B200LIG	SCJD6A200LIG	SCJD6B200LIG
300	SJD6A300LIG	SJD6B300LIG	SHJD6A300LIG	SHJD6B300LIG	SCJD6A300LIG	SCJD6B300LIG
400	SJD6A400LIG	SJD6B400LIG	SHJD6A400LIG	SHJD6B400LIG	SCJD6A400LIG	SCJD6B400LIG
200	SJD6A200LSI	SJD6B200LSI	SHJD6A200LSI	SHJD6B200LSI	SCJD6A200LSI	SCJD6B200LSI
300	SJD6A300LSI	SJD6B300LSI	SHJD6A300LSI	SHJD6B300LSI	SCJD6A300LSI	SCJD6B300LSI
400	SJD6A400LSI	SJD6B400LSI	SHJD6A400LSI	SHJD6B400LSI	SCJD6A400LSI	SCJD6B400LSI
200	SJD6A200LSIG	SJD6B200LSIG	SHJD6A200LSIG	SHJD6B200LSIG	SCJD6A200LSIG	SCJD6B200LSIG
300	SJD6A300LSIG	SJD6B300LSIG	SHJD6A300LSIG	SHJD6B300LSIG	SCJD6A300LSIG	SCJD6B300LSIG
400	SJD6A400LSIG	SJD6B400LSIG	SHJD6A400LSIG	SHJD6B400LSIG	SCJD6A400LSIG	SCJD6B400LSIG

SJD 400A Frame – 100% Rated^②

Blue Label

Black Label

Max Current Rating	3-Pole, 600V AC		3-Pole, 600V AC	
	Catalogue Number (Advanced trip unit) ^③	Catalogue Number (Basic trip unit)	Catalogue Number (Advanced trip unit) ^③	Catalogue Number (Basic trip unit)
200	SJD6A200LIH	SJD6B200LIH	SHJD6A200LIH	SHJD6B200LIH
300	SJD6A300LIH	SJD6B300LIH	SHJD6A300LIH	SHJD6B300LIH
400	SJD6A400LIH	SJD6B400LIH	SHJD6A400LIH	SHJD6B400LIH
200	SJD6A200LIGH	SJD6B200LIGH	SHJD6A200LIGH	SHJD6B200LIGH
300	SJD6A300LIGH	SJD6B300LIGH	SHJD6A300LIGH	SHJD6B300LIGH
400	SJD6A400LIGH	SJD6B400LIGH	SHJD6A400LIGH	SHJD6B400LIGH
200	SJD6A200LSIH	SJD6B200LSIH	SHJD6A200LSIH	SHJD6B200LSIH
300	SJD6A300LSIH	SJD6B300LSIH	SHJD6A300LSIH	SHJD6B300LSIH
400	SJD6A400LSIH	SJD6B400LSIH	SHJD6A400LSIH	SHJD6B400LSIH
200	SJD6A200LSIGH	SJD6B200LSIGH	SHJD6A200LSIGH	SHJD6B200LSIGH
300	SJD6A300LSIGH	SJD6B300LSIGH	SHJD6A300LSIGH	SHJD6B300LSIGH
400	SJD6A400LSIGH	SJD6B400LSIGH	SHJD6A400LSIGH	SHJD6B400LSIGH

Ordering Information

Pricing information for all Digital Sentron Series SJD Frames is for complete breaker only - price required lugs as separate items - lugs are suitable for 75°C Wire.

Shipping Weights

Breaker Type	Number per Carton	Shipping Weight (lbs)
SJD6-B	1	20
SHJD6-B	1	20
SCJD6-B	1	33

Lugs for 75°C Wire^①

Catalogue Number	No. of cables per connector	Wire Range
TA2J6500	2	#3/0-500 kcmil Cu
	2	#4/0-500 kcmil Al
TA1L6750	1	500-750 kcmil Al
	1	500-600 kcmil Cu
TC1J6600	1	#3/0-600 kcmil Cu
TC2J6500	2	#3/0-500 kcmil Cu
TA2J630	2	#4-#3/0 Cu/Al
Compression Lug		
CCL600	1 (pc.)	#1/0-500 kcmil Cu/Al

Trip Unit Adjustable Functions

Suffix Letter Code	Trip Type	Cont Current Setting	Long Time Delay	Instantaneous Pick Up	Short Time Pick Up	Short Time Fixed Delay	Short Time In't Delay	Ground Fault Pick Up	Ground Fault Delay
LI	LI	✓	✓	✓					
LIG	LIG	✓	✓	✓				✓	✓
LSI	LSI	✓	✓	✓	✓	✓	✓		
LSIG	LSIG	✓	✓	✓	✓	✓	✓	✓	✓

Interrupting Ratings

Breaker Type	RMS Symmetrical kA UL 489 (File E10848)		
	240V AC	480V AC	600V AC
SJD6-B	65	35	25
SHJD6-B	100	65	35
SCJD6-B	200	150	100

Neutral Transformers

Ampere Rating	Catalogue Number
200	N02SJD
300	N03SJD
400	N04SJD

Note: "G" suffix in catalog number denotes circuit breaker for 3-phase, 3-wire systems. For 3-phase, 4-wire, order correct 4th wire (neutral) transformer as separate and additional item.

All breakers built to order. Allow 2-3 weeks for delivery.
 ① For additional information, see Note: A, page 5-147.
 ② Refer to the NEC for proper application of 100% rated devices.
 ③ Advanced trip unit equipped with DAS / Maintenance Mode. Requires customer-supplied 24V external power supply, maintenance switch and light.

Enclosures page 5-139 – 5-146
 Accessories pages 5-151 - 5-159

Molded Case Circuit Breakers

Internal Accessories

Selection

Accessories for:

JD 400A Frame
LD 600A Frame
LMD 800A Frame
SJD 400A Frame
SLD 600A Frame



Shunt Trip Combinations

Control Voltage		1 Shunt Trip	1 Shunt Trip and 1 Auxiliary Switch
AC	DC	Catalogue Number	Catalogue Number
24	—	S17JLD6	—
48	—	S18JLD6	—
120	—	S01JLD6	S01JLD62A
240	—	S03JLD6	S03JLD62A
277	—	S15JLD6	S15JLD64A
480	—	S04JLD6	—
—	12	S16JLD6	S16JLD62A
—	24	S07JLD6	S07JLD62A
—	48	S09JLD6	S09JLD62A
—	125	S11JLD6	S11JLD62A
—	250	S13JLD6	S13JLD62A

Undervoltage Trip Combinations

Control Voltage		1 Undervoltage Trip	1 Undervoltage Trip and 1 Auxiliary Switch	1 Undervoltage Trip and 2 Auxiliary Switches
AC	DC	Catalogue Number	Catalogue Number	Catalogue Number
120	—	U01JLD6	U01JLD62A	U01JLD62AA
208	—	U02JLD6	U02JLD62A	U02JLD62AA1
240	—	U03JLD6	U03JLD62A	U03JLD62AA1
480	—	U06JLD6	U06JLD64A	U06JLD64AA1
—	24	U13JLD6	U13JLD62A	U13JLD62AA1
—	48	U14JLD6	U14JLD62A	U14JLD62AA1
—	125	U10JLD6	U10JLD62A	U10JLD62AA
—	250	U12JLD6	U12JLD62A	U12JLD62AA1

Auxiliary Switch Combinations

Maximum Voltage		1 Form C	2 Form C
AC	DC	Catalogue Number	Catalogue Number
480	250	A01JLD64	A02JLD64
—	12	A01JLDLV	A02JIDLV

Alarm Switch Combinations

Maximum Voltage		1 Alarm Switch	1 Alarm Switch and 1 Auxiliary Switch	1 Alarm Switch and 2 Auxiliary Switches
AC	DC	Catalogue Number	Catalogue Number	Catalogue Number
480	250	B01JLD64	A01JLD64B	A02JLD64B

ETU Testing Unit

Breaker Type	Description	Catalogue Number
SJD, SLD, SMD, SND, SPD	Power Stick	EPSP18V
	Spare cable for Power Stick	COMPCA

The EPSP18V Power Stick is a hand-held, battery-operated power supply that can be used for trip testing the Sensitrip IV electronic trip units. Requires two 9V batteries.

Note: Accessory modules can only be added to right side pole of solid state SJD and SLD frame circuit breakers. All accessories on this page are useable on superseded JD2, JJ6, JL6, HJ6, SJJ, LJ6, LL6, HL6 and SLL circuit breakers.

No accessories can be added if mechanical interlock is used.

Molded Case Circuit Breakers

LD 600A Frame Sentron Series

Selection

Type LXD6-A^{①④}

Blue Label

Non-Interchangeable Trip (Assembled Circuit Breaker without Lugs)				
Continuous Current Rating @ 40°C	2-Pole (3 Pole Width)		3-Pole	
	600V AC	250V DC	600V AC	500V DC
	Catalogue Number		Catalogue Number	
450	LXD62B450		LXD63B450	E
500	LXD62B500		LXD63B500	
600	LXD62B600		LXD63B600	

Type JD6-A^⑤

Blue Label

Interchangeable Trip				
Continuous Current Rating @ 40°C	Complete Breaker Unassembled with Lugs	Frame Only	Trip Unit Only	
	Catalogue Number	Catalogue Number	Catalogue Number	
2-Pole 600V AC, 250V DC (3 Pole Width)				
250	LD62B250	LD62F600	JD62T250	
300	LD62B300		JD62T300	
350	LD62B350		JD62T350	
400	LD62B400		JD62T400	
450	LD62B450		LD62T450	
500	LD62B500		LD62T500	
600	LD62B600		LD62T600	
3-Pole 600V AC, 500V DC^②				
250	LD63B250	LD63F600	JD63T250	
300	LD63B300		JD63T300	
350	LD63B350		JD63T350	
400	LD63B400		JD63T400	
450	LD63B450		LD63T450	
500	LD63B500		LD63T500	
600	LD63B600		LD63T600	

3-Pole 600V AC, 500V DC^②

250	LD63B250	LD63F600	JD63T250	
300	LD63B300		JD63T300	
350	LD63B350		JD63T350	
400	LD63B400		JD63T400	
450	LD63B450		LD63T450	
500	LD63B500		LD63T500	
600	LD63B600		LD63T600	

Interrupting Ratings

Breaker Type	RMS Symmetrical Amperes (KA)										
	CSA / UL 489 AIR (File E10848)					IEC 947-2					
	Volts AC (50/60Hz)			Volts DC		220/240			380/415		500
	240	480	600	250	500 ^③	(Icu)	(Ics)	(Icu)	(Ics)	(Icu)	(Ics)
LXD6, LD6	65	35	25	30 (2-P)	25 (3-P)	65	33	40	20	30	15
HLD6, HLXD6	100	65	35	30 (2-P)	35 (3-P)	100	50	65	33	42	21
HHL6, HHLXD6	200	100	50	—	—	200	100	100	50	65	33
CLD6	200	150	100	30 (2-P)	50 (3-P)	—	—	—	—	—	—

Instantaneous Adjustment Trip Range

Breaker Ampere Rating	Nominal Instantaneous Values							
	Low ^⑤	2	3	4	5	6	7	High ^⑤
250-300	1250	1430	1610	1790	1960	2140	2320	2500
350-450	2000	2290	2570	2860	3140	3430	3710	4000
500-600	3000	3430	3800	4290	4710	5140	5570	6000

① Type LXD6A circuit breakers are CSA Certified / UL Listed for reverse fed applications.

② When wired as shown on page 5-4, this circuit breaker is CSA Certified / UL Listed and rated for use on 500V DC ungrounded UPS systems only.

③ See Note: A, page 5-147.

④ HACR rated.

⑤ +/- 20% Tolerance

Note: LD frame qualified to UL489 supplement SB "NAVAL" See page 5-137 for additional information.

Ordering Information

Complete Breaker Unassembled with Lugs

Prices of LD6, HLD6, and HHL6 breakers include frame, trip, and both line and load lugs (TA2J6500). When ordered by these catalogue numbers, the customer will receive the frame, trip and lugs separately packaged. For applications requiring different lugs, order individual items as needed.

Complete Breaker Assembled without Lugs

Prices of LXD6, HLXD6, HHLXD6, and CLD6 include frame with non-interchangeable trip unit installed only. Order required lugs separately. For line and load lugs (TA2J6500) installed, add suffix "L" to catalogue number (add 2 times list price of lugs for each pole).

100% Rated (3-pole only)

Types, LXD6 and HLXD6 breakers are available with 100% ratings. To order add suffix "H" to catalogue number, and 10% to list price. 100% rated LD breakers require the use of 90°C Cu cable and lugs TC1J6600 or TC2J6500.

50°C Applications see page 5-137.

400Hz Applications see page 5-137.

Shipping Weights

Number of Poles	Number per Carton	Shipping Weight (lbs.)
LXD6, LD6, HLD6, HHL6		
Assembled Breaker (less terminals)		
2	1	17.5
3	1	19.5
LD6, HLD6, HHL6 Frame Only		
2	1	14
3	1	15.5
LD6, HHL6 Trip Unit Only		
2	1	3.5
3	1	4
CLD6 Complete Assembled Breaker (less terminals)		
2	1	29.5
3	1	31.5

Lugs for 75°C Wire^⑥

Catalogue Number	No. of cables per connector	Wire Range
TA2J6500	1, 2	#3/0 500 kcmil Cu #4/0 500 kcmil Al
TC2J6500	2	#3/0-500 kcmil Cu
TA1L6750	1	500-750 kcmil Al 500-600 kcmil Cu
TC1J6600	1	#3/0-600 kcmil Cu
Compression Lug		
CCL600	1	500 kcmil Cu/Al

Modifications page 5-150
Accessories page 5-151 - 5-159

Molded Case Circuit Breakers

LD 600A Frame Sentron Series

Selection

Type HLD6-A, HLXD6^{②③④}

Black Label

Interchangeable Trip			
Continuous Current Rating @ 40°C	Complete Breaker Unassembled with Lugs	Frame Only	Trip Unit Only
	Catalogue Number	Catalogue Number	Catalogue Number

2-Pole 600V AC, 250V DC (3 Pole Width)

Current Rating	Complete Breaker Unassembled with Lugs	Frame Only	Trip Unit Only
250	HLD62B250	HLD62F600	JD62T250
300	HLD62B300		JD62T300
350	HLD62B350		JD62T350
400	HLD62B400		JD62T400
450	HLD62B450		LD62T450
500	HLD62B500		LD62T500
600	HLD62B600		LD62T600

3-Pole 600V AC, 500V DC^{①⑤}

Current Rating	Complete Breaker Unassembled with Lugs	Frame Only	Trip Unit Only
250	HLD63B250	HLD63F600	JD63T250
300	HLD63B300		JD63T300
350	HLD63B350		JD63T350
400	HLD63B400		JD63T400
450	HLD63B450		LD63T450
500	HLD63B500		LD63T500
600	HLD63B600		LD63T600

Type HHL6, HHLXD6^{②③④}

2-Pole 600V AC (3 Pole Width)

Current Rating	Complete Breaker Unassembled with Lugs	Frame Only	Trip Unit Only
250	HHL62B250	HHL62F600	JD62T250
300	HHL62B300		JD62T300
350	HHL62B350		JD62T350
400	HHL62B400		JD62T400
450	HHL62B450		HHL62T450
500	HHL62B500		HHL62T500
600	HHL62B600		HHL62T600

3-Pole 600V AC

Current Rating	Complete Breaker Unassembled with Lugs	Frame Only	Trip Unit Only
250	HHL63B250	HHL63F600	JD63T250
300	HHL63B300		JD63T300
350	HHL63B350		JD63T350
400	HHL63B400		JD63T400
450	HHL63B450		HHL63T450
500	HHL63B500		HHL63T500
600	HHL63B600		HHL63T600

Type CLD6^④

Red Label

Fuseless Current Limiting

Non-Interchangeable Trip (Assembled Circuit Breaker Without Lugs)		
Continuous Current Rating @ 40°C	2-Pole	3-Pole
	600V AC/250V DC	600V AC/500V DC
		Catalogue Number
450	For 2-pole application use outside poles of 3-pole circuit breaker	CLD63B450
500		CLD63B500
600		CLD63B600

For inches / millimeters conversion, see Technical section

① When wired as shown on page 5-4, this circuit breaker is CSA Certified / UL Listed and rated for use on 500V DC ungrounded UPS systems only.

② For complete assembled 3 pole HLD6 or HHL6 type circuit breaker change the prefix identifier HLD6 or HHL6 to HLXD6 or HHLXD6. Price is sum of frame and trip units prices, e.g. price of HLXD63B400 is the price of HLD63F600 plus the price of LD63T600. Order the terminal connectors separately.

③ Type HLXD6, HHLXD6 Circuit Breakers are CSA Certified / UL Listed for reverse feed applications.

④ LX6-ETI, CLD6-ETI see page 5-117 for ordering information.

⑤ CE Applies to non-interchangeable type HLXD only.

⑥ HACR rated.

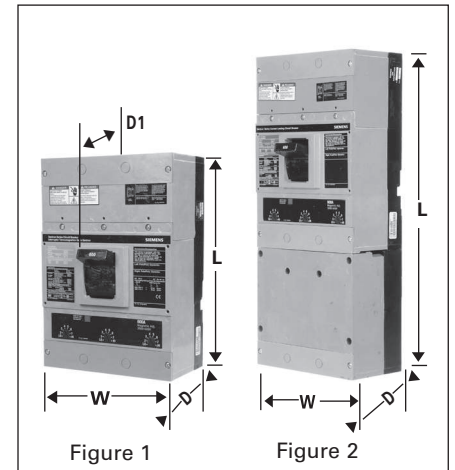

Dimensions (in inches)

Breaker Type	W	L	D	D1 (to handle)
Figure 1 LXD6-A, LD6-A HLD6-A HHL6, HHLXD6, LXD6-ETI ^④	7.5	11	4	5.44
Figure 2 CLD6, CLD6-ETI ^④	7.5	17.86	4	5.44

Molded Case Circuit Breakers

SLD 600A Frame Digital Solid State Sentron Sensitrip IV Series

Selection

Type SLD6-B

Blue Label

Type SHLD6-B

Black Label

Current Limiting

Type SCLD6-B

Red Label

Max Current Rating	3-Pole, 600V AC		3-Pole, 600V AC		3-Pole, 600V AC	
	Catalogue Number (Advanced trip unit) ^①	Catalogue Number (Basic trip unit)	Catalogue Number (Advanced trip unit) ^①	Catalogue Number (Basic trip unit)	Catalogue Number (Advanced trip unit) ^①	Catalogue Number (Basic trip unit)
300	SLD6A300LI	SLD6B300LI	SHLD6A300LI	SHLD6B300LI	SCLD6A300LI	SCLD6B300LI
400	SLD6A400LI	SLD6B400LI	SHLD6A400LI	SHLD6B400LI	SCLD6A400LI	SCLD6B400LI
500	SLD6A500LI	SLD6B500LI	SHLD6A500LI	SHLD6B500LI	SCLD6A500LI	SCLD6B500LI
600	SLD6A600LI	SLD6B600LI	SHLD6A600LI	SHLD6B600LI	SCLD6A600LI	SCLD6B600LI
300	SLD6A300LIG	SLD6B300LIG	SHLD6A300LIG	SHLD6B300LIG	SCLD6A300LIG	SCLD6B300LIG
400	SLD6A400LIG	SLD6B400LIG	SHLD6A400LIG	SHLD6B400LIG	SCLD6A400LIG	SCLD6B400LIG
500	SLD6A500LIG	SLD6B500LIG	SHLD6A500LIG	SHLD6B500LIG	SCLD6A500LIG	SCLD6B500LIG
600	SLD6A600LIG	SLD6B600LIG	SHLD6A600LIG	SHLD6B600LIG	SCLD6A600LIG	SCLD6B600LIG
300	SLD6A300LSI	SLD6B300LSI	SHLD6A300LSI	SHLD6B300LSI	SCLD6A300LSI	SCLD6B300LSI
400	SLD6A400LSI	SLD6B400LSI	SHLD6A400LSI	SHLD6B400LSI	SCLD6A400LSI	SCLD6B400LSI
500	SLD6A500LSI	SLD6B500LSI	SHLD6A500LSI	SHLD6B500LSI	SCLD6A500LSI	SCLD6B500LSI
600	SLD6A600LSI	SLD6B600LSI	SHLD6A600LSI	SHLD6B600LSI	SCLD6A600LSI	SCLD6B600LSI
300	SLD6A300LSIG	SLD6B300LSIG	SHLD6A300LSIG	SHLD6B300LSIG	SCLD6A300LSIG	SCLD6B300LSIG
400	SLD6A400LSIG	SLD6B400LSIG	SHLD6A400LSIG	SHLD6B400LSIG	SCLD6A400LSIG	SCLD6B400LSIG
500	SLD6A500LSIG	SLD6B500LSIG	SHLD6A500LSIG	SHLD6B500LSIG	SCLD6A500LSIG	SCLD6B500LSIG
600	SLD6A600LSIG	SLD6B600LSIG	SHLD6A600LSIG	SHLD6B600LSIG	SCLD6A600LSIG	SCLD6B600LSIG

Trip Unit Adjustable Functions

Suffix Letter Code	Trip Type	Cont Current Setting	Long Time Delay	Instantaneous Pick Up	Short Time Pick Up	Short Time Fixed Delay	Short Time f't Delay	Ground Fault Pick Up	Ground Fault Delay
LI	LI	✓	✓	✓					
LIG	LIG	✓	✓	✓				✓	✓
LSI	LSI	✓	✓	✓	✓	✓	✓		
LSIG	LSIG	✓	✓	✓	✓	✓	✓	✓	✓

Ordering Information

Pricing information for all Digital Sentron Series SLD Frames is for complete breaker only – price required lugs as separate items – lugs are suitable for 75°C Wire.

Interrupting Ratings

Breaker Type	RMS Symmetrical kA UL 489 (File E10848)		
	240V AC	480V AC	600V AC
SLD6-B	65	35	25
SHLD6-B	100	65	35
SCLD6-B	200	150	100

Neutral Transformers

Ampere Rating	Catalogue Number
300	N03SJD
400	N04SJD
500	N05SLD
600	N06SLD

Shipping Weights

Breaker Type	Number per Carton	Shipping Weight (lbs)
SLD6-B	1	20
SHLD6-B	1	20
SCLD6-B	1	33

Note: "G" suffix in catalog number denotes circuit breaker for 3-phase, 3-wire circuits. For 3-phase, 4-wire, order correct 4th wire (neutral) transformer as separate and additional item.

For ordering information to terminal connectors see page 5-147 - 5-149; for enclosures, see page 5-139 – 5-146.

100% Rated – Not available in SLD6 Frame.

All breakers built to order. Allow 2-3 weeks for delivery.

^① Advanced trip unit equipped with DAS / Maintenance Mode. Requires customer-supplied 24V external power supply, maintenance switch and light.

5

MOLDED CASE
CIRCUIT BREAKERS

Molded Case Circuit Breakers

Internal Accessories

Selection

Accessories for:

- JD 400A Frame
- LD 600A Frame
- LMD 800A Frame
- SJD 400A Frame
- SLD 600A Frame



Shunt Trip Combinations

Control Voltage		1 Shunt Trip	1 Shunt Trip and 1 Auxiliary Switch
AC	DC	Catalogue Number	Catalogue Number
24	—	S17JLD6	—
48	—	S18JLD6	—
120	—	S01JLD6	S01JLD62A
240	—	S03JLD6	S03JLD62A
277	—	S15JLD6	S15JLD64A
480	—	S04JLD6	—
—	12	S16JLD6	S16JLD62A
—	24	S07JLD6	S07JLD62A
—	48	S09JLD6	S09JLD62A
—	125	S11JLD6	S11JLD62A
—	250	S13JLD6	S13JLD62A

Auxiliary Switch Combinations

Maximum Voltage		1 Form C	2 Form C
AC	DC	Catalogue Number	Catalogue Number
480	250	A01JLD64	A02JLD64
—	12	A01JLDLV	A02JLDLV

Alarm Switch Combinations

Maximum Voltage		1 Alarm Switch	1 Alarm Switch and 1 Auxiliary Switch	1 Alarm Switch and 2 Auxiliary Switches
AC	DC	Catalogue Number	Catalogue Number	Catalogue Number
480	250	B01JLD64	A01JLD64B	A02JLD64B

ETU Testing Unit

Breaker Type	Description	Catalogue Number
SJD, SLD, SMD, SND, SPD	Power Stick	EPSP18V
	Spare cable for Power Stick	COMPCA

The EPSP18V Power Stick is a hand-held, battery-operated power supply that can be used for trip testing the Sensitrip IV electronic trip units. Requires two 9V batteries.

Note: Accessory modules can only be added to right side pole of solid state SJD and SLD frame circuit breakers. All accessories on this page are useable on superseded JD2, JJ6, JL6, HJ6, SJL, LJ6, LL6, HL6 and SLL circuit breakers.

No accessories can be added if mechanical interlock is used.

Molded Case Circuit Breakers

LMD 800A Frame Sentron Series

Selection

Type LMXD6^{①⑤}

Blue Label

Non-Interchangeable Trip (Assembled Circuit Breaker without Lugs)		
Continuous Current Rating @ 40°C	2-Pole (3 Pole Width) Catalogue Number	3-Pole Catalogue Number
500	—	LMXD63B500
600	LMXD62B600	LMXD63B600
700	LMXD62B700	LMXD63B700
800	LMXD62B800	LMXD63B800

Type LMD6^⑥

Blue Label

Interchangeable Trip			
Continuous Current Rating @ 40°C	Complete Breaker Unassembled with Lugs	Frame Only	Trip Unit Only
	Catalogue Number	Catalogue Number	Catalogue Number
2-Pole 600V AC, 250V DC (3 Pole Width)			
500	LMD62B500	LMD62F800	LMD62T500
600	LMD62B600		LMD62T600
700	LMD62B700		LMD62T700
800	LMD62B800		LMD62T800

3-Pole 600V AC, 500V DC^⑤

500	LMD63B500	LMD63F800	LMD63T500
600	LMD63B600		LMD63T600
700	LMD63B700		LMD63T700
800	LMD63B800		LMD63T800

Instantaneous Adjustment Trip Range

Breaker Ampere Rating	Nominal Instantaneous Values							
	Low ^⑥	2	3	4	5	6	7	High ^⑥
500-600	3000	3430	3860	4290	4710	5140	5570	6000
700-800	3200	3500	3700	4200	4700	6400	7300	8000

① LMXD6 circuit breakers are CSA Certified / UL Listed for reverse connected applications.
② Use 6 lugs for 3-pole, use 4 connectors for 2-pole.

③ When wired as shown on page 5-4, this circuit breaker is CSA Certified / UL Listed and rated for use on 500UDC ungrounded UPS systems only.
④ See **Note: A**, page 5-147.
⑤ HACR rated.
⑥ +/- 20% Tolerance

Ordering Information

Complete Breaker Unassembled with Lugs

Prices of LMD6 and HLMD6 breakers include frame, trip, and both line and load lugs (TA3K500). These catalogue numbers include the frame, trip and lugs separately packaged. For applications requiring different lugs, order individual items as needed.

Complete Breaker Assembled without Lugs

Prices of LMXD6 and HLMXD6 include frame with non-interchangeable trip unit installed only. Order required lugs separately. For line and load lugs (TA3K500) installed, add suffix "L" to catalogue number (add 2 times list price of lugs for each pole).

50°C Applications see page 5-137.

400Hz Applications see page 5-137.

Shipping Weights

Number of Poles	Number per Carton	Shipping Weight (lbs.)
LMD6, HLMD6, LMXD6, HLMXD6 Complete Breaker (less terminals)		
2	1	53
3	1	61.5
LMD6, HLMD6 Frame Only		
2	1	42.25
3	1	46
LMD6, HLMD6 Trip Unit Only		
2	1	4.5
3	1	6.5

Lugs for 75°C Wire^③

Catalogue Number	No. of cables per connector	Wire Range
TA2K500	1, 2	#1-500 kcmil Cu/ Al
TA3K500	1-3	#1/0-500 kcmil Cu/ Al
TA2N750	1, 2	500-750 kcmil Cu/ Al

Modifications page 5-150
Accessories page 5-151-159

Molded Case Circuit Breakers

LMD 800A Frame Sentron Series

Selection/Dimensions

Type HLMXD6^④

Black Label

Non-Interchangeable Trip (Assembled Circuit Breaker without Lugs)		
Continuous Current Rating @ 40°C	2-Pole 600V AC/ 250V DC	3-Pole 600V AC/ 500V DC
		Catalogue Number
500	For 2-Pole application use outside poles of 3-Pole circuit breaker.	HLMXD63B500
600		HLMXD63B600
700		HLMXD63B700
800		HLMXD63B800

Type HLMD6^④

Black Label

Interchangeable Trip			
Continuous Current Rating @ 40°C	Complete Breaker Unassembled with Lugs	Frame Only	Trip Unit Only
	Catalogue Number	Catalogue Number	Catalogue Number
2-Pole 600V AC, 250V DC (3 Pole Width)			
500	HLMD62B500	HLMD62F800	LMD62T500
600	HLMD62B600		LMD62T600
700	HLMD62B700		LMD62T700
800	HLMD62B800		LMD62T800

3-Pole 600V AC, 500V DC^⑤

500	HLMD63B500	HLMD63F800	LMD63T500
600	HLMD63B600		LMD63T600
700	HLMD63B700		LMD63T700
800	HLMD63B800		LMD63T800

Interrupting Ratings

Breaker Type	RMS Symmetrical Amperes (KA)										
	CSA / UL 489 AIR (File E10848)					IEC 947-2					
	Volts AC (50/60Hz)			Volts DC		Volts AC (50/60Hz)					
	240	480	600	250	500 ^③	220/240		380/415		500	
					(lcu)	(lcs)	(lcu)	(lcs)	(lcu)	(lcs)	
LMD6, LMXD6	65	50	25	30 (2-P)	25 (3-P)	65	33	40	20	30	15
HLMD6, HLMXD6	100	65	50	30 (2-P)	50 (3-P)	100	50	65	33	42	21

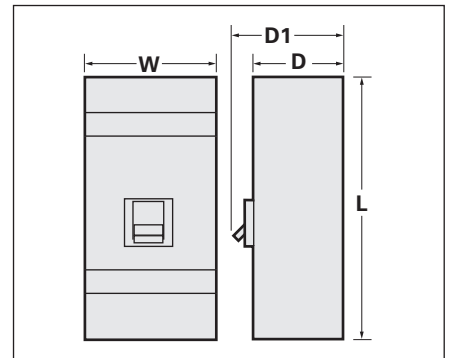

Dimensions (in inches)

Breaker Type	W	L	D	D1
LMD6, LMXD6, HLMD6, HLMXD6, LMXD6-ETI ^⑥	7.5	16	4.5	5.93

For inches / millimeters conversion, see Technical section.

① HLMXD6 circuit breakers are CSA Certified / UL Listed for reverse connection applications.
② LMXD6-ETI, see page 5-117 for catalogue information.

③ When wired as shown on page 5-4, this circuit breaker is CSA Certified / UL Listed and rated for use on 500VDC ungrounded UPS systems only.
④ HACR rated.

Molded Case Circuit Breakers

Internal Accessories

Selection

Accessories for:

JD 400A Frame
LD 600A Frame
LMD 800A Frame
SJD 400A Frame
SLD 600A Frame



Shunt Trip Combinations

Control Voltage		1 Shunt Trip	1 Shunt Trip and 1 Auxiliary Switch
AC	DC	Catalogue Number	Catalogue Number
24	—	S17JLD6	—
48	—	S18JLD6	—
120	—	S01JLD6	S01JLD62A
240	—	S03JLD6	S03JLD62A
277	—	S15JLD6	S15JLD64A
480	—	S04JLD6	—
—	12	S16JLD6	S16JLD62A
—	24	S07JLD6	S07JLD62A
—	48	S09JLD6	S09JLD62A
—	125	S11JLD6	S11JLD62A
—	250	S13JLD6	S13JLD62A

Undervoltage Trip Combinations

Control Voltage		1 Undervoltage Trip	1 Undervoltage Trip and 1 Auxiliary Switch	1 Undervoltage Trip and 2 Auxiliary Switches
AC	DC	Catalogue Number	Catalogue Number	Catalogue Number
120	—	U01JLD6	U01JLD62A	U01JLD62AA
208	—	U02JLD6	U02JLD62A	U02JLD62AA
240	—	U03JLD6	U03JLD62A	U03JLD62AA
277	—	U16JLD6	U16JLD64A	U16JLD62AA
480	—	U06JLD6	U06JLD64A	U06JLD64AA
600	—	U08JLD6	—	—
—	24	U13JLD6	U13JLD62A	U13JLD62AA
—	48	U14JLD6	U14JLD62A	U14JLD62AA
—	125	U10JLD6	U10JLD62A	U10JLD62AA
—	250	U12JLD6	U12JLD62A	U12JLD62AA

Auxiliary Switch Combinations

Maximum Voltage		1 Form C*	2 Form C
AC	DC	Catalogue Number	Catalogue Number
480	250	A01JLD64	A02JLD64
—	12	A01JLDLV	A02JLDLV

Alarm Switch Combinations

Maximum Voltage		1 Alarm Switch	1 Alarm Switch and 1 Auxiliary Switch	1 Alarm Switch and 2 Auxiliary Switches
AC	DC	Catalogue Number	Catalogue Number	Catalogue Number
480	250	B01JLD64	A01JLD64B	A02JLD64B

ETU Testing Unit

Breaker Type	Description	Catalogue Number
SJD, SLD, SMD, SND, SPD	Power Stick	EPSP18V
	Spare cable for Power Stick	COMPCA

The EPSP18V Power Stick is a hand-held, battery-operated power supply that can be used for trip testing the Sensitrip IV electronic trip units. Requires two 9V batteries.

Note: Accessory modules can only be added to right side pole of solid state SJD and SLD frame circuit breakers. All accessories on this page are useable on superseded JD2, JJ6, JL6, HJ6, SJL, LJ6, LL6, HL6 and SLL circuit breakers.

No accessories can be added if mechanical interlock is used.

Molded Case Circuit Breakers

MD 800A Frame Sentron Series

Selection

Type MXD6^{1⑦}

Blue Label

Non-Interchangeable Trip (Assembled Circuit Breaker Without Lugs)		
Continuous Current Rating @ 40°C	2-Pole	3-Pole
	Catalogue Number	Catalogue Number
600	MXD62B600	MXD63B600
700	MXD62B700	MXD63B700
800	MXD62B800	MXD63B800

Type MD6⁷

Blue Label

Non-Interchangeable Trip (Assembled Circuit Breaker Without Lugs)			
Continuous Current Rating @ 40°C	Complete Breaker Unassembled with Lugs	Frame Only	Trip Unit Only
	Catalogue Number	Catalogue Number	Catalogue Number

2-Pole 600V AC, 250V DC^②

Continuous Current Rating @ 40°C	Complete Breaker Unassembled with Lugs	Frame Only	Trip Unit Only
500	MD62B500	MD62F800	MD62T500
600	MD62B600		MD62T600
700	MD62B700		MD62T700
800	MD62B800		MD62T800

3-Pole 600V AC, 500V DC^④

Continuous Current Rating @ 40°C	Complete Breaker Unassembled with Lugs	Frame Only	Trip Unit Only
500	MD63B500	MD63F800	MD63T500
600	MD63B600		MD63T600
700	MD63B700		MD63T700
800	MD63B800		MD63T800

Lugs^⑤

Catalogue Number	Cables per Lug	Lugs Per Kit	Wire Range
TA2K500	1-2	1	#1-500 kcmil Cu/ Al
TA3K500	1-3	1	1/0-500 kcmil Cu/ Al
TC2K500	1-2	1	#1-500 kcmil Cu
TC3K350	1-3	1	#1-350 kcmil Cu
Kits			
2TA2N8750	1-2	2	600-750 kcmil Cu/ Al
3TA2N8750		3	
2TA3N8750	1-3	2	500-750 kcmil Cu/ Al
3TA3N8750		3	
2TA4N8500	1-4	2	250-500 kcmil Cu/ Al
3TA4N8500		3	
2TA4P8500	1-4	2	250-500 kcmil Cu/Al
3TA4P8500		3	

Instantaneous Adjustment Trip Range

Breaker Ampere Rating	Nominal Instantaneous Values							
	Low ^⑧	2	3	4	5	6	7	High ^⑧
500-600	3000	3430	3860	4280	4710	5140	5570	6000
700-800	4000	4570	5140	5710	6280	6850	7420	8000

①MXD6 circuit breakers are CSA Certified / UL Listed for reverse connection applications.

②2-pole units available in 3-pole width only.

③Use 6 connectors for 3-pole, use 4 connectors for 2-pole.

④ When wired as shown on page 5-4, this circuit breaker is CSA Certified / UL Listed and rated for use on 500V DC ungrounded UPS systems.

⑤ See Note: A, page 5-147.

⑥80% rated breakers with the CE mark will also be marked in the 100% rated version.

⑦ HACR rated.

⑧ +/- 20% Tolerance.

Note: MD frame qualified to UL489 supplement B "NAVAL" See page 5-150 for additional information.

Ordering Information

Complete Breaker Unassembled with Lugs

Pricing information for MD6 and HMD6 breakers includes frame, trip, and both line and load lugs (TA3K500). When ordered by these catalogue numbers, the customer will receive the frame, trip and lugs separately packaged. For applications requiring different lugs, order individual items as needed.

Complete Breaker Assembled without Lugs

Prices of MXD6, HMXD6 and CMD6 include frame with non-interchangeable trip units installed only. Order required lugs separately. For line and load lugs (TA3K500) installed, add suffix "L" to catalogue number (add 2 times list price of lugs for each pole).

100% Rated^⑥

Types MXD6, HMXD6 and CMD6 breakers are available with 100% ratings. To order add suffix "H" to catalogue number, and 10% to list price. 100% rated MD breakers require the use of 90°C Cu cable and lugs 2TA4P8500 or 2TA2N8750 for 2-pole; 3TA4P8500 or 3TA2N8750 for 3-pole.

50°C Applications see page 5-137.

400Hz Applications see page 5-137.

Shipping Weights

Number of Poles	Number per Carton	Shipping Weight (lbs.)
MD6, HMD6, HMXD6, CMD6		
Complete Breaker Assembled (less lugs)		
2	1	53
3	1	61.5
MD6, HMD6 Frame Only		
2	1	42.25
3	1	46
MD6, HMD6 Trip Unit Only		
2	1	4.5
3	1	6.5

Modifications page 5-150
Accessories page 5-151 - 5-159

Molded Case Circuit Breakers

MD 800A Frame Sentron Series

Selection/Dimensions

Type HMXD6^③

Black Label

Non-Interchangeable Trip (Assembled Circuit Breaker without Lugs)		
Continuous Current Rating @ 40°C	2-Pole	3-Pole
		600V AC/250V DC
		Catalogue Number
600	For 2-pole application use outside poles of 3-pole circuit breaker	HMXD63B600
700		HMXD63B700
800		HMXD63B800

Type HMD6^⑤

Black Label

Interchangeable Trip			
Continuous Current Rating @ 40°C	Complete Breaker Unassembled with Lugs	Frame Only	Trip Unit Only
	Catalogue Number	Catalogue Number	Catalogue Number

2-Pole 600V AC, 250V DC^②

Continuous Current Rating @ 40°C	Complete Breaker Unassembled with Lugs	Frame Only	Trip Unit Only
500	HMD62B500	HMD62F800	MD62T500
600	HMD62B600		MD62T600
700	HMD62B700		MD62T700
800	HMD62B800		MD62T800

3-Pole 600V AC, 500V DC^④

Continuous Current Rating @ 40°C	Complete Breaker Unassembled with Lugs	Frame Only	Trip Unit Only
500	HMD63B500	HMD63F800	MD63T500
600	HMD63B600		MD63T600
700	HMD63B700		MD63T700
800	HMD63B800		MD63T800

Type CMD6^⑤

Fuseless Current Limiting

Red Label

Non-Interchangeable Trip (Assembled Circuit Breaker Without Lugs)		
Continuous Current Rating @ 40°C	2-Pole	3-Pole
		600V AC/250V DC
		Catalogue Number
500	For 2-pole application use outside poles of 3-pole circuit breaker	CMD63B500
600		CMD63B600
700		CMD63B700
800		CMD63B800

Interrupting Ratings

Breaker Type	RMS Symmetrical Amperes (KA)										
	CSA / UL 489 AIR (File E10848)					IEC 947-2					
	Volts AC (50/60Hz)			Volts DC		Volts AC (50/60Hz)					
	240	480	600	250	500 ^③	220/240		380/415		500	
MD6, MXD6	65	50	25	30 (2-P)	25 (3-P)	65	33	40	20	30	15
HMD6, HMXD6	100	65	50	30 (2-P)	50 (3-P)	100	50	65	33	42	21
CMD6	200	100	65	30 (2-P)	50 (3-P)	200	100	100	50	65	33

For inches / millimeters conversion, see Technical section.

③HMXD6 circuit breakers are CSA Certified / UL Listed for reverse connection applications.

②2-pole units available in 3-pole width only.

④MXD6-ETI, CMD6-ETI see page 5-117 for catalogue information.

④When wired as shown on page 5-4, this circuit breaker is CSA Certified / UL Listed and rated for use on 500V DC ungrounded UPS systems only.

⑤HACR rated.

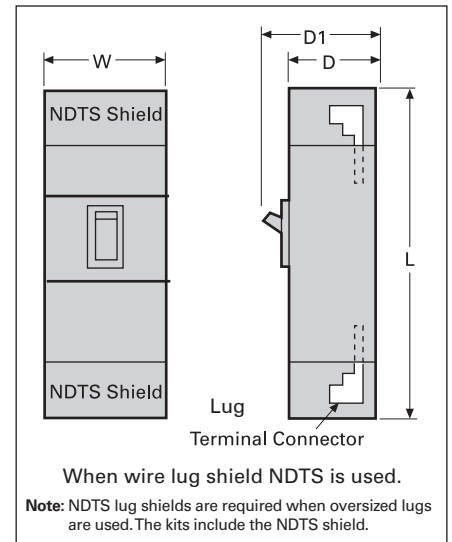

Dimensions (in inches)

Breaker Type	W	L	D	D1
MD6, MXD6, HMD6, HMXD6, CMD6, MXD6-ETI, CMD6-ETI	9	16	6	8.25
with lug shields	9	24	6	8.25

Molded Case Circuit Breakers

SMD 800A Frame Digital Solid State Sentron Sensitrip IV Series

Selection

Type SMD6

Blue Label

Type SHMD6-B

Black Label

Current Limiting

Type SCMD6-B

Red Label

Max Current Rating	3-Pole, 600V AC		3-Pole, 600V AC		3-Pole, 600V AC	
	Catalogue Number (Advanced trip unit) ^③	Catalogue Number (Basic trip unit)	Catalogue Number (Advanced trip unit) ^③	Catalogue Number (Basic trip unit)	Catalogue Number (Advanced trip unit) ^③	Catalogue Number (Basic trip unit)
600	SMD6A600LI	SMD6B600LI	SHMD6A600LI	SHMD6B600LI	SCMD6A600LI	SCMD6B600LI
700	SMD6A700LI	SMD6B700LI	SHMD6A700LI	SHMD6B700LI	SCMD6A700LI	SCMD6B700LI
800	SMD6A800LI	SMD6B800LI	SHMD6A800LI	SHMD6B800LI	SCMD6A800LI	SCMD6B800LI
600	SMD6A600LIG	SMD6B600LIG	SHMD6A600LIG	SHMD6B600LIG	SCMD6A600LIG	SCMD6B600LIG
700	SMD6A700LIG	SMD6B700LIG	SHMD6A700LIG	SHMD6B700LIG	SCMD6A700LIG	SCMD6B700LIG
800	SMD6A800LIG	SMD6B800LIG	SHMD6A800LIG	SHMD6B800LIG	SCMD6A800LIG	SCMD6B800LIG
600	SMD6A600LSI	SMD6B600LSI	SHMD6A600LSI	SHMD6B600LSI	SCMD6A600LSI	SCMD6B600LSI
700	SMD6A700LSI	SMD6B700LSI	SHMD6A700LSI	SHMD6B700LSI	SCMD6A700LSI	SCMD6B700LSI
800	SMD6A800LSI	SMD6B800LSI	SHMD6A800LSI	SHMD6B800LSI	SCMD6A800LSI	SCMD6B800LSI
600	SMD6A600LSIG	SMD6B600LSIG	SHMD6A600LSIG	SHMD6B600LSIG	SCMD6A600LSIG	SCMD6B600LSIG
700	SMD6A700LSIG	SMD6B700LSIG	SHMD6A700LSIG	SHMD6B700LSIG	SCMD6A700LSIG	SCMD6B700LSIG
800	SMD6A800LSIG	SMD6B800LSIG	SHMD6A800LSIG	SHMD6B800LSIG	SCMD6A800LSIG	SCMD6B800LSIG

SMD 800A Frame – 100% Rated^①

Blue Label

Black Label

Current Limiting

Red Label

Max Current Rating	3-Pole, 600V AC		3-Pole, 600V AC		3-Pole, 600V AC	
	Catalogue Number (Advanced trip unit) ^③	Catalogue Number (Basic trip unit)	Catalogue Number (Advanced trip unit) ^③	Catalogue Number (Basic trip unit)	Catalogue Number (Advanced trip unit) ^③	Catalogue Number (Basic trip unit)
600	SMD6A600LIH	SMD6B600LIH	SHMD6A600LIH	SHMD6B600LIH	SCMD6A600LIH	SCMD6B600LIH
700	SMD6A700LIH	SMD6B700LIH	SHMD6A700LIH	SHMD6B700LIH	SCMD6A700LIH	SCMD6B700LIH
800	SMD6A800LIH	SMD6B800LIH	SHMD6A800LIH	SHMD6B800LIH	SCMD6A800LIH	SCMD6B800LIH
600	SMD6A600LIGH	SMD6B600LIGH	SHMD6A600LIGH	SHMD6B600LIGH	SCMD6A600LIGH	SCMD6B600LIGH
700	SMD6A700LIGH	SMD6B700LIGH	SHMD6A700LIGH	SHMD6B700LIGH	SCMD6A700LIGH	SCMD6B700LIGH
800	SMD6A800LIGH	SMD6B800LIGH	SHMD6A800LIGH	SHMD6B800LIGH	SCMD6A800LIGH	SCMD6B800LIGH
600	SMD6A600LSIH	SMD6B600LSIH	SHMD6A600LSIH	SHMD6B600LSIH	SCMD6A600LSIH	SCMD6B600LSIH
700	SMD6A700LSIH	SMD6B700LSIH	SHMD6A700LSIH	SHMD6B700LSIH	SCMD6A700LSIH	SCMD6B700LSIH
800	SMD6A800LSIH	SMD6B800LSIH	SHMD6A800LSIH	SHMD6B800LSIH	SCMD6A800LSIH	SCMD6B800LSIH
600	SMD6A600LSIGH	SMD6B600LSIGH	SHMD6A600LSIGH	SHMD6B600LSIGH	SCMD6A600LSIGH	SCMD6B600LSIGH
700	SMD6A700LSIGH	SMD6B700LSIGH	SHMD6A700LSIGH	SHMD6B700LSIGH	SCMD6A700LSIGH	SCMD6B700LSIGH
800	SMD6A800LSIGH	SMD6B800LSIGH	SHMD6A800LSIGH	SHMD6B800LSIGH	SCMD6A800LSIGH	SCMD6B800LSIGH

5
MOLDED CASE
CIRCUIT BREAKERS

Ordering Information		
Pricing information for all Digital Sentron Series MD frames is for complete breaker only. Price requires lugs or lug kits as separate items. Lugs are suitable for 75°C wire or as noted. Connector wire ranges and cavities are established in conjunction with Table 6.1.4.2.1 of UL 489 standards. Choose actual connector for circuit breakers based on customer requirements.		
Recommended Terminal Connectors		
Breaker Frame	Ampere Rating	Connector or Connector Kit
MD	500-600	TA2K500
MD	700-800	TA3K500
Types SMD6-B, SHMD6-B and SCMD6-B are acceptable for reverse connection applications		

Lugs for 75°C Wire^②

Catalogue Number	Cables per Lug	Wire Range	Each kit contains the following:
TA2K500	2	#1-500 kcmil Cu/Al	
TA3K500	3	#1-500 kcmil Cu/Al	
TC2K500	2	#1-500 kcmil Cu	
TC3K350	3	#1-350 kcmil Cu	
Kits (3 lugs/kit)			
3TA4N8500	4	250-500 kcmil Cu/Al	
3TA4P8500	4	250-500 kcmil Cu/Al	
3TA2N8750	2	500-750 kcmil Cu/Al	
3TA3N8750	3	500-750 kcmil Cu/Al	

Trip Unit Adjustable Functions

Suffix Letter Code	Trip Type	Cont Current Setting	Long Time Delay	Instantaneous Pick Up	Short Time Pick Up	Short Time Delay	Ground Fault Pick Up	Ground Fault Delay
LI	LI	✓	✓	✓				
LIG	LIG	✓	✓	✓			✓	✓
LSI	LSI	✓	✓	✓	✓	✓		
LSIG	LSIG	✓	✓	✓	✓	✓	✓	✓

Interrupting Ratings

Breaker Type	RMS Symmetrical kA UL 489 (File E10848)		
	240V AC	480V AC	600V AC
SMD6-B	65	50	25
SHMD6-B	100	65	50
SCMD6-B	200	100	65

Neutral Transformers

Ampere Rating	Catalogue Number
600	N06SMDA
700	N07SMDA
800	N08SMDA

Note: "G" suffix in catalog number denotes circuit breaker for 3-phase, 3-wire circuits. For 3-phase, 4-wire, order correct 4th wire (neutral) transformer as separate and additional item.

① Use 2-3TA4P8500 for 3-pole. These kits are rated for 90°C wire. 90°C Cu only cable must be used, and sized per 75°C ampacity.
② For additional information, see Note: A, page 5-147.

③ Advanced trip unit equipped with DAS / Maintenance Mode. Requires customer-supplied 24V external power supply, maintenance switch and light.

Enclosures page 5-139 – 5-146
Accessories pages 5-151 - 5-159

Molded Case Circuit Breakers

Internal Accessories

Selection

Accessories for:

MD/SMD 800A Frame
ND/SND 1200A Frame
PD/SPD 1600A Frame
RD 2000A Frame



Accessory modules can mount in either left hand or right hand poles of all circuit breakers, including solid state. Exception: when mechanical interlock is used accessories cannot be mounted in left pole.

Shunt Trip Combinations

Control Voltage		1 Shunt Trip	1 Shunt Trip and 1 Auxiliary Switch
AC	DC	Catalogue Number	Catalogue Number
120	—	S01MN6	S01MN64A
208	—	S02MN6	S02MN64A
240	—	S03MN6	S03MN64A
277	—	S15MN6	S15MN64A
480	—	S04MN6	S04MN64A
600	—	S06MN6	—
—	12	S16MN6	S16MN64A
—	24	S07MN6	S07MN64A
—	48	S09MN6	—
—	125	S11MN6	S11MN64A
—	250	S13MN6	S13MN64A

Undervoltage Trip Combinations

Control Voltage		1 Undervoltage Trip	1 Undervoltage Trip and 1 Auxiliary Switch	1 Undervoltage Trip and 2 Auxiliary Switches
AC	DC	Catalogue Number	Catalogue Number	Catalogue Number
120	—	U01MN6	U01MN64A	U01MN64AA
208	—	U02MN6	U02MN64A	U02MN64AA
240	—	U03MN6	U03MN64A	U03MN64AA
277	—	U15MN6	U15MN64A	U15MN64AA
480	—	U04MN6	U04MN64A	U04MN64AA
600	—	U06MN6	—	—
—	24	U07MN6	U07MN64A	U07MN64AA
—	48	U09MN6	U09MN64A	U09MN64AA
—	125	U11MN6	U11MN64A	U11MN64AA
—	250	U13MN6	U13MN64A	U13MN64AA

Auxiliary Switch Combinations

Maximum Voltage		1 Form C	2 Form C
AC	DC	Catalogue Number	Catalogue Number
480	250	A01MN64	A02MN64
—	12	A01MNDLV	A02MNDLV

Alarm Switch Combinations

Maximum Voltage		1 Alarm Switch	1 Alarm Switch and 1 Auxiliary Switch	1 Alarm Switch and 2 Auxiliary Switches
AC	DC	Catalogue Number	Catalogue Number	Catalogue Number
480	250	B00MN64	A01MN64B	A02MN64B

ETU Testing Unit

Breaker Type	Description	Catalogue Number
SJD, SLD, SMD, SND, SPD	Power Stick	EPSP18V
	Spare cable for Power Stick	COMPCA

The EPSP18V Power Stick is a hand-held, battery-operated power supply that can be used for trip testing the Sensitrip IV electronic trip units. Requires two 9V batteries.

Molded Case Circuit Breakers

ND 1200A Frame Sentron Series

Selection

Type NXD6^①

Blue Label

Non-Interchangeable Trip (Assembled Circuit Breaker without Lugs)		
Continuous Current Rating @ 40°C	2-Pole 600V AC/ 250V DC	3-Pole 600V AC/500V DC
	Catalogue Number	Catalogue Number
900	NXD62B900	NXD63B900
1000	NXD62B100	NXD63B100
1200	NXD62B120	NXD63B120

Type ND6^②

Blue Label

Interchangeable Trip			
Continuous Current Rating @ 40°C	Complete Breaker Unassembled with Lugs	Frame Only	Trip Unit Only
	Catalogue Number	Catalogue Number	Catalogue Number

2-Pole 600V AC, 250V DC^②

Continuous Current Rating @ 40°C	Catalogue Number	Frame Only Catalogue Number	Trip Unit Only Catalogue Number
800	ND62B800	ND62F120	MD62T800
900	ND62B900		MD62T900
1000	ND62B100		MD62T100
1200	ND62B120		MD62T120

3-Pole 600V AC, 500V DC^⑤

Continuous Current Rating @ 40°C	Catalogue Number	Frame Only Catalogue Number	Trip Unit Only Catalogue Number
800	ND63B800	ND63F120	MD63T800
900	ND63B900		MD63T900
1000	ND63B100		MD63T100
1200	ND63B120		MD63T120

Interrupting Ratings

Breaker Type	RMS Symmetrical Amperes (KA)										
	CSA / UL 489 AIR (File E10848)					IEC 947-2					
	Volts AC (50/60Hz)			Volts DC		Volts AC (50/60Hz)					
	240	480	600	250	500 ^③	220/240		380/415		500	
					(lcu)	(lcs)	(lcu)	(lcs)	(lcu)	(lcs)	
ND6, NXD6	65	50	25	30 (2-P)	25 (3-P)	65	33	40	20	—	—
HND6, HNXD6	100	65	50	30 (2-P)	50 (3-P)	100	50	65	33	—	—
CND6	200	100	65	—	50 (3-P)	—	—	—	—	—	—

Instantaneous Adjustment Trip Range

Breaker Ampere Rating	Nominal Instantaneous Values							
	Low ^④	2	3	4	5	6	7	High ^④
800	4000	4570	5140	5710	6280	6850	7420	8000
900-1200	5000	5715	6430	7145	7860	8575	9290	10000

① NXD6 circuit breakers are CSA Certified / UL Listed for reverse connection applications.

② 2-pole units available in 3-pole width only.

③ When wired as shown on page 5-4, this circuit breaker is CSA Certified / UL Listed and rated for use on 500VDC ungrounded UPS systems only.

④ Use 6 connectors for 3-pole, use 4 connectors for 2-pole.

⑤ Use 2 - 3TA4P8500 kits for 3-pole, or 2 - 2TA4P8500 kits for 2-pole. Rated for 90°C cable. Use for 100% rated breakers.

⑥ Use 2 - 3TA4N8500 for 3-pole or 2 - 2TA4N8500 for 2-pole. Rated for 75°C cable.

⑦ See **Note: A**, page 5-147.

⑧ 80% rated breakers with the CE mark will also be marked in the 100% rated version.

⑨ HACR rated.

⑩ +/- 20% Tolerance.

Note: ND frame qualified to UL489 supplement B "NAVAL" See page 5-150 for additional information.

Ordering Information

Complete Breaker Unassembled with Lugs

Prices of ND6 and HND6 breakers include frame, trip, and both line and load lugs (3TA4N8500). These catalogue numbers are the frame, trip and lugs separately packaged. For applications requiring different lugs, order individual items as needed.

Complete Breaker Assembled without Lugs

Prices of NXD6, HNXD6, and CND6 include frame with non-interchangeable trip units installed only. Order required terminal connectors separately.

For line and load lugs (3TA4N8500) installed, add suffix "L" to catalogue number (add 2 times list price of lug kit).

100% Rated^⑧

Types NXD6, HNXD6 and CND6 breakers are available with 100% ratings. To order, suffix "H" to catalogue number, and add 10% to list price. 100% rated ND breakers require 90°C Cu cable and lug kit 3TA4P8500 or 3TA3N8750.

50°C Applications see page 5-137.

400Hz Applications see page 5-137.

Lugs^⑦

Catalogue Number	Cables per Lug	Wire Range
TA2K500	2	#1-500 kcmil Cu/ Al
TA3K500	3	#1-500 kcmil Cu/ Al
TC2K500	2	#1-500 kcmil Cu
TC3K350	3	#1-350 kcmil Cu
Kits (2 Kits required per breaker)		
2TA4P8500 ^⑤	4	250-500 kcmil Cu/ Al
3TA4P8500 ^⑤		
2TA4N8500 ^⑥	4	250-500 kcmil Cu/ Al
3TA4N8500 ^⑥		
2TA2N8750	2	500-750 kcmil Cu/ Al
3TA2N8750		
2TA3N8750	3	500-750 kcmil Cu/ Al
3TA3N8750		

Modifications page 5-150
Accessories page 5-151 - 5-159

Molded Case Circuit Breakers

ND 1200A Frame Sentron Series

Selection/Dimensions

Type HNXD6^{①④}

Black Label

Non-Interchangeable Trip (Assembled Circuit Breaker without Lugs)		
Continuous Current Rating @ 40°C	2-Pole 600V AC/250V DC	3-Pole 600V AC/500V DC Catalogue Number
900 1000 1200	For 2-pole application use outside poles of 3-pole circuit breaker	HNXD63B900 HNXD63B100 HNXD63B120

Type HND6^④

Black Label

Interchangeable Trip			
Continuous Current Rating @ 40°C	Complete Breaker Unassembled with Lugs	Frame Only	Trip Unit Only
	Catalogue Number	Catalogue Number	Catalogue Number

2-Pole 600V AC, 250V DC^②

800 900 1000 1200	For 2-pole application use outside poles of 3-pole circuit breaker
----------------------------	--

3-Pole 600V AC, 500V DC^⑤

800 900 1000 1200	HND63B800 HND63B900 HND63B100 HND63B120	HND63F120	MD63T800 ND63T900 ND63T100 ND63T120
----------------------------	--	-----------	--

Type CND6^{①④}

Fuseless Current Limiting

Red Label

Non-Interchangeable Trip (Assembled Circuit Breaker)		
Continuous Current Rating @ 40°C	2-Pole	3-Pole Catalogue Number
900 1000 1200	For 2-pole application, use outside poles of 3-pole circuit breaker	CND63B900 CND63B100 CND63B120

Shipping Weights

Number of Poles	Number per Carton	Shipping Weight (lbs.)
ND6, HND6, NXD6, HNXD6, CND6 Assembled Breaker (less terminals)		
2	1	53
3	1	61.5
ND6, HND6 Frame Only		
2	1	42.25
3	1	46
ND6, HND6 Trip Unit Only		
2	1	4.5
3	1	6.5

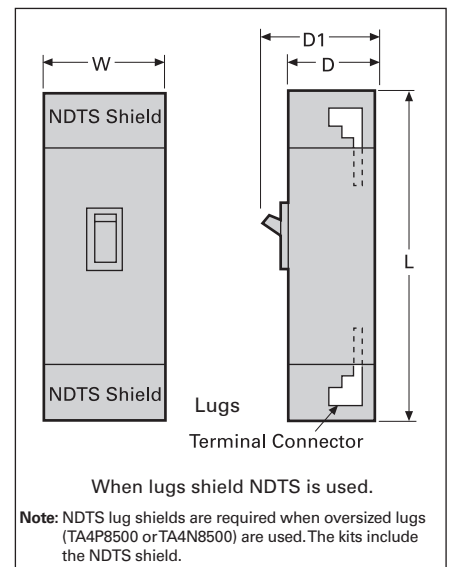

Dimensions (in inches)

Breaker Type	W	L	D	D1
ND6, NXD6, HND6, HNXD6, CND6	9	16	6	8.25
with NDTs lug shield	9	29	6	8.25

For inches / millimeters conversion, see Technical section.

① HNXD6 and CND6 circuit breakers are CSA Certified / UL Listed for reverse connection applications.
② 2-pole units available in 3-pole width only.

③ When wired as shown on page 5-4, this circuit breaker is CSA Certified / UL Listed and rated for use on 500V DC ungrounded UPS systems only.

④ HACR rated.

Molded Case Circuit Breakers

SND 1200A Frame Digital Solid State Sentron Sensitrip IV Series^②

Selection

Type SND6-B

Blue Label

Type SHND6-B

Black Label

Current Limiting

Type SCND6-B

Red Label

Max Current Rating	3-Pole, 600V AC		3-Pole, 600V AC		3-Pole, 600V AC	
	Catalogue Number (Advanced trip unit) ^③	Catalogue Number (Basic trip unit)	Catalogue Number (Advanced trip unit) ^③	Catalogue Number (Basic trip unit)	Catalogue Number (Advanced trip unit) ^③	Catalogue Number (Basic trip unit)
800	SND6A800LI	SND6B800LI	SHND6A800LI	SHND6B800LI	SCND6A800LI	SCND6B800LI
1000	SND6A100LI	SND6B100LI	SHND6A100LI	SHND6B100LI	SCND6A100LI	SCND6B100LI
1200	SND6A120LI	SND6B120LI	SHND6A120LI	SHND6B120LI	SCND6A120LI	SCND6B120LI
800	SND6A800LIG	SND6B800LIG	SHND6A800LIG	SHND6B800LIG	SCND6A800LIG	SCND6B800LIG
1000	SND6A100LIG	SND6B100LIG	SHND6A100LIG	SHND6B100LIG	SCND6A100LIG	SCND6B100LIG
1200	SND6A120LIG	SND6B120LIG	SHND6A120LIG	SHND6B120LIG	SCND6A120LIG	SCND6B120LIG
800	SND6A800LSI	SND6B800LSI	SHND6A800LSI	SHND6B800LSI	SCND6A800LSI	SCND6B800LSI
1000	SND6A100LSI	SND6B100LSI	SHND6A100LSI	SHND6B100LSI	SCND6A100LSI	SCND6B100LSI
1200	SND6A120LSI	SND6B120LSI	SHND6A120LSI	SHND6B120LSI	SCND6A120LSI	SCND6B120LSI
800	SND6A800LSIG	SND6B800LSIG	SHND6A800LSIG	SHND6B800LSIG	SCND6A800LSIG	SCND6B800LSIG
1000	SND6A100LSIG	SND6B100LSIG	SHND6A100LSIG	SHND6B100LSIG	SCND6A100LSIG	SCND6B100LSIG
1200	SND6A120LSIG	SND6B120LSIG	SHND6A120LSIG	SHND6B120LSIG	SCND6A120LSIG	SCND6B120LSIG

SND 1200A Frame – 100% Rated^①

Type SND6-B

Blue Label

Type SHND6-B

Black Label

Current Limiting

Type SCND6-B

Red Label

Max Current Rating	3-Pole, 600V AC		3-Pole, 600V AC		3-Pole, 600V AC	
	Catalogue Number (Advanced trip unit) ^③	Catalogue Number (Basic trip unit)	Catalogue Number (Advanced trip unit) ^③	Catalogue Number (Basic trip unit)	Catalogue Number (Advanced trip unit) ^③	Catalogue Number (Basic trip unit)
800	SND6A800LIH	SND6B800LIH	SHND6A800LIH	SHND6B800LIH	SCND6A800LIH	SCND6B800LIH
1000	SND6A100LIH	SND6B100LIH	SHND6A100LIH	SHND6B100LIH	SCND6A100LIH	SCND6B100LIH
1200	SND6A120LIH	SND6B120LIH	SHND6A120LIH	SHND6B120LIH	SCND6A120LIH	SCND6B120LIH
800	SND6A800LIGH	SND6B800LIGH	SHND6A800LIGH	SHND6B800LIGH	SCND6A800LIGH	SCND6B800LIGH
1000	SND6A100LIGH	SND6B100LIGH	SHND6A100LIGH	SHND6B100LIGH	SCND6A100LIGH	SCND6B100LIGH
1200	SND6A120LIGH	SND6B120LIGH	SHND6A120LIGH	SHND6B120LIGH	SCND6A120LIGH	SCND6B120LIGH
800	SND6A800LSIH	SND6B800LSIH	SHND6A800LSIH	SHND6B800LSIH	SCND6A800LSIH	SCND6B800LSIH
1000	SND6A100LSIH	SND6B100LSIH	SHND6A100LSIH	SHND6B100LSIH	SCND6A100LSIH	SCND6B100LSIH
1200	SND6A120LSIH	SND6B120LSIH	SHND6A120LSIH	SHND6B120LSIH	SCND6A120LSIH	SCND6B120LSIH
800	SND6A800LSIGH	SND6B800LSIGH	SHND6A800LSIGH	SHND6B800LSIGH	SCND6A800LSIGH	SCND6B800LSIGH
1000	SND6A100LSIGH	SND6B100LSIGH	SHND6A100LSIGH	SHND6B100LSIGH	SCND6A100LSIGH	SCND6B100LSIGH
1200	SND6A120LSIGH	SND6B120LSIGH	SHND6A120LSIGH	SHND6B120LSIGH	SCND6A120LSIGH	SCND6B120LSIGH

Trip Unit Adjustable Functions

Suffix Letter Code	Trip Type	Cont Current Setting	Long Time Delay	Instantaneous Pick Up	Short Time Pick Up	Short Time Fixed Pick Up	Short Time I ² t Delay	Ground Fault Pick Up	Ground Fault Delay
LI	LI	✓	✓	✓					
LIG	LIG	✓	✓	✓				✓	✓
LSI	LSI	✓	✓	✓	✓	✓	✓		
LSIG	LSIG	✓	✓	✓	✓	✓	✓	✓	✓

Interrupting Ratings

Breaker Type	RMS Symmetrical kA UL 489 (File E10848)		
	240V AC	480V AC	600V AC
SND6-B	65	50	25
SHND6-B	100	65	50
SCND6-B	200	100	65

Neutral Transformers

Ampere Rating	Catalogue Number
800	N08SMDA
1000	N10SNDA
1200	N12SNDA

For inches / millimeters conversion, see Technical Data section.

For ordering information to terminal connectors see page 5-147 - 5-149; for enclosures, see page 5-139 - 5-146.

Note: "G" suffix in catalog number denotes circuit breaker for 3-phase, 3-wire circuits.
For 3-phase, 4-wire, order correct 4th wire (neutral) transformer as separate and additional item.

All breakers built to order. Allow 2-3 weeks for delivery.

① Use 2-3TA4P8500 for 3-pole. These kits are rated for 90°C wire. 90°C Cu only cable must be used, and sized per 75°C ampacity.

② SND6, SHND6 and SCND6 circuit breakers are UL Listed for reverse connection applications.

③ Advanced trip unit equipped with DAS / Maintenance

Mode. Requires customer-supplied 24V external power supply, maintenance switch and light.

Molded Case Circuit Breakers

Internal Accessories

Selection

Accessories for:

MD/SMD 800A Frame
ND/SND 1200A Frame
PD/SPD 1600A Frame
RD 2000A Frame



Accessory modules can mount in either left hand or right hand poles of all circuit breakers, including solid state. Exception: when mechanical interlock is used accessories cannot be mounted in left pole.

Shunt Trip Combinations

Control Voltage		1 Shunt Trip	1 Shunt Trip and 1 Auxiliary Switch
AC	DC	Catalogue Number	Catalogue Number
120	—	S01MN6	S01MN64A
208	—	S02MN6	S02MN64A
240	—	S03MN6	S03MN64A
277	—	S15MN6	S15MN64A
480	—	S04MN6	S04MN64A
600	—	S06MN6	—
—	12	S16MN6	S16MN64A
—	24	S07MN6	S07MN64A
—	48	S09MN6	—
—	125	S11MN6	S11MN64A
—	250	S13MN6	S13MN64A

Undervoltage Trip Combinations

Control Voltage		1 Undervoltage Trip	1 Undervoltage Trip and 1 Auxiliary Switch	1 Undervoltage Trip and 2 Auxiliary Switches
AC	DC	Catalogue Number	Catalogue Number	Catalogue Number
120	—	U01MN6	U01MN64A	U01MN64AA
208	—	U02MN6	U02MN64A	U02MN64AA
240	—	U03MN6	U03MN64A	U03MN64AA
277	—	U15MN6	U15MN64A	U15MN64AA
480	—	U04MN6	U04MN64A	U04MN64AA
600	—	U06MN6	—	—
—	24	U07MN6	U07MN64A	U07MN64AA
—	48	U09MN6	U09MN64A	U09MN64AA
—	125	U11MN6	U11MN64A	U11MN64AA
—	250	U13MN6	U13MN64A	U13MN64AA

Auxiliary Switch Combinations

Maximum Voltage		1 Form C	2 Form C
AC	DC	Catalogue Number	Catalogue Number
480	250	A01MN64	A02MN64
—	12	A01MNDLV	A02MNDLV

Alarm Switch Combinations

Maximum Voltage		1 Alarm Switch	1 Alarm Switch and 1 Auxiliary Switch	1 Alarm Switch and 2 Auxiliary Switches
AC	DC	Catalogue Number	Catalogue Number	Catalogue Number
480	250	B00MN64	A01MN64B	A02MN64B

ETU Testing Unit

Breaker Type	Description	Catalogue Number
SJD, SLD, SMD, SND, SPD	Power Stick	EPSP18V
	Spare cable for Power Stick	COMPCA

The EPSP18V Power Stick is a hand-held, battery-operated power supply that can be used for trip testing the Sensitrip IV electronic trip units. Requires two 9V batteries.

Molded Case Circuit Breakers

PD 1600A Frame Sentron Series

Selection

Type PXD6² Non-Interchangeable Trip⁵

3-Pole 600V AC, 250-500V DC¹

Blue Label

Continuous Current Rating @ 40°C	Complete Breaker Assembled (Frame/Trip Unit Only)	Mounting Assembly	Lugs (6 required)
	Catalogue Number	Catalogue Number	Catalogue Number
1200	PXD63B120	MB9301	TA5P600
1400	PXD63B140	-or-	
1600	PXD63B160	MBR9302	

Type PD6 Interchangeable Trip⁵

3-Pole 600V AC, 250-500V DC¹

Blue Label

Continuous Current Rating @ 40°C	Complete Breaker Unassembled	Frame Only	Trip Unit Only	Mounting Assembly	Lugs (6 required)
	Catalogue Number	Catalogue Number	Catalogue Number	Catalogue Number	Catalogue Number
1200	PD63B120	PD63F160	PD63T120	MB9301	TA5P600
1400	PD63B140		PD63T140	-or-	
1600	PD63B160		PD63T160	MBR9302	

Type HPXD6² Non-Interchangeable Trip⁵

3-Pole 600V AC, 250-500V DC¹

Blue Label

Continuous Current Rating @ 40°C	Complete Breaker Assembled (Frame/Trip Unit Only)	
	Catalogue Number	
1200	HPXD63B120	
1400	HPXD63B140	
1600	HPXD63B160	

Type HPD6 Interchangeable Trip⁵

3-Pole 600V AC, 250-500V DC¹

Black Label

Continuous Current Rating @ 40°C	Complete Breaker Unassembled	Frame Only	Trip Unit Only	Mounting Assembly	Lugs (6 required)
	Catalogue Number	Catalogue Number	Catalogue Number	Catalogue Number	Catalogue Number
1200	HPD63B120	HPD63F160	PD63T120	MB9301	TA5P600
1400	HPD63B140		PD63T140	-or-	
1600	HPD63B160		PD63T160	MBR9302	

Type CPD6 Non-Interchangeable Trip⁵

Fuseless Current Limiting
3-Pole 600V AC, 250-500V DC¹

Red Label

Continuous Current Rating @ 40°C	Complete Breaker Assembled (Frame/Trip Unit Only)
	Catalogue Number
1200	CPD63B120
1400	CPD63B140
1600	CPD63B160

Ordering Instructions

Complete Breaker Unassembled with Lugs

Prices of PD6, HPD6, RD6, and HRD6 type breakers include frame, trip, mounting base (MB9301), and both line and load lugs (PD Frame – TA5P600, RD Frame – TC5R600). When ordered by these catalogue numbers, the customer will receive the frame, trip, mounting assembly and lugs separately packaged. For applications requiring different mounting base or lugs, order individual items as needed.

Complete Breaker Assembled without Lugs

Prices of PXD6, HPXD6, RXD6, HRXD6 and CPD6 type breakers include frame with non-interchangeable trip unit installed only. Order required mounting base and lugs separately.

100% Rated (3-Pole only)

Types PXD6, HPXD6 breakers are available with 100% ratings. To order add suffix "H" to catalogue number, and 10% to list price. 100% PD breakers require 90° C cable sized at 75° C ampacity and TC5R600 lugs. RD 2000A Frames not available with 100% ratings.

50°C Applications see page 5-137.

400HZ Applications see page 5-137.

Lugs (6 required per breaker)⁴

Catalogue Number	No of Cables per Connector	Wire Range
TA5P600	1-5	300-600 kcmil Cu/Al
TC5R600	1-5	300-600 kcmil Cu only
TA4P750	1-4	500-750 kcmil Cu/Al
TA6R600	1-6	300-600 kcmil Cu/Al

Interrupting Ratings

Breaker Type	CSA 22.2 No. 5 / UL 489 A IR				
	RMS Symmetrical KA				
	Volts AC			Volts DC ¹	
	240	480	600	250	500
PD6, PXD6	65	50	25	30 (2P)	25 (3P)
HPD6, HPXD6	100	65	50	30 (2P)	50 (3P)
CPD6	200	100	65	30 (2P)	50 (3P)

Mounting Bases for PD & RD

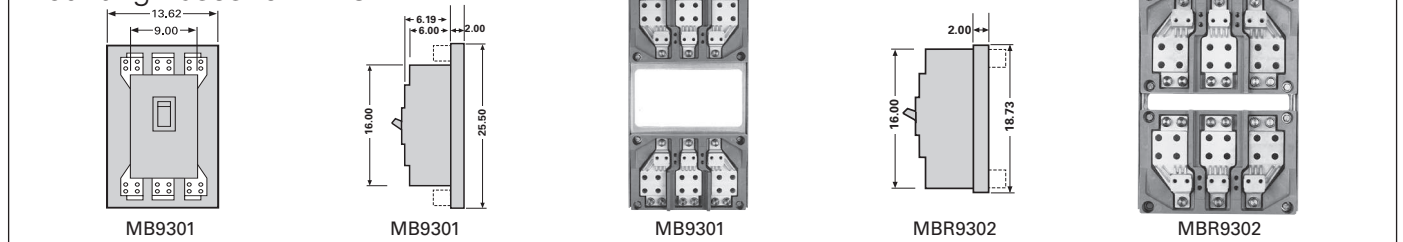

¹ Use two outside poles of a 3-pole circuit breaker for 250V
² When wired as shown on page 5-4, this circuit breaker is CSA Certified / UL Listed and rated for use on 500V DC ungrounded UPS systems only.

³ PXD6, HPXD6 and CPD6 type circuit breakers are CSA Certified / UL Listed for reverse feed applications.
⁴ For additional information See **Note: A**, page 5-147.
⁵ HACR rated.

Note: PD frame qualified to UL489 supplement B "NAVAL"
 See page 5-150 for additional information.

Molded Case Circuit Breakers

SPD 1600A Frame Digital Solid State Sentron Sensitrip IV Series

Selection/Dimensions

Type SPD6-B

Blue Label

Type SHPD6-B

Black Label

Max Current Rating	3-Pole, 600V AC		3-Pole, 600V AC	
	Catalogue Number (Advanced trip unit) ^③	Catalogue Number (Basic trip unit)	Catalogue Number (Advanced trip unit) ^③	Catalogue Number (Basic trip unit)
1400	SPD6A140LI	SPD6B140LI	SHPD6A140LI	SHPD6B140LI
1600	SPD6A160LI	SPD6B160LI	SHPD6A160LI	SHPD6B160LI
1400	SPD6A140LIG	SPD6B140LIG	SHPD6A140LIG	SHPD6B140LIG
1600	SPD6A160LIG	SPD6B160LIG	SHPD6A160LIG	SHPD6B160LIG
1400	SPD6A140LSI	SPD6B140LSI	SHPD6A140LSI	SHPD6B140LSI
1600	SPD6A160LSI	SPD6B160LSI	SHPD6A160LSI	SHPD6B160LSI
1400	SPD6A140LSIG	SPD6B140LSIG	SHPD6A140LSIG	SHPD6B140LSIG
1600	SPD6A160LSIG	SPD6B160LSIG	SHPD6A160LSIG	SHPD6B160LSIG

Ordering Information

Pricing information for all Digital Sentron Series PD frame unit is for breaker only. Price required mounting block assembly and necessary terminal connectors as separate items.

Trip Unit Adjustable Functions

Suffix Letter Code	Trip Type	Cont Current Setting	Long Time Delay	Instantaneous Pick Up	Short Time Pick Up	Short Time Fixed Delay	Short Time f't Delay	Ground Fault Pick Up	Ground Fault Delay
LI	LI	✓	✓	✓					
LIG	LIG	✓	✓	✓				✓	✓
LSI	LSI	✓	✓	✓	✓	✓	✓		
LSIG	LSIG	✓	✓	✓	✓	✓	✓	✓	✓

Neutral Transformers

Ampere Rating	Catalogue Number
1400	N14SPD
1600	N16SPD

Interrupting Ratings

Breaker Type	RMS Symmetrical kA CSA 22.2 No. 5 / UL 489		
	240V AC	480V AC	600V AC
SPD6-B	65	50	25
SHPD6-B	100	65	50

Mounting Block (Required)^②

Catalogue Number
MB9301
MBR9302

5 MOLDED CASE CIRCUIT BREAKERS

All PD, RD Frames:

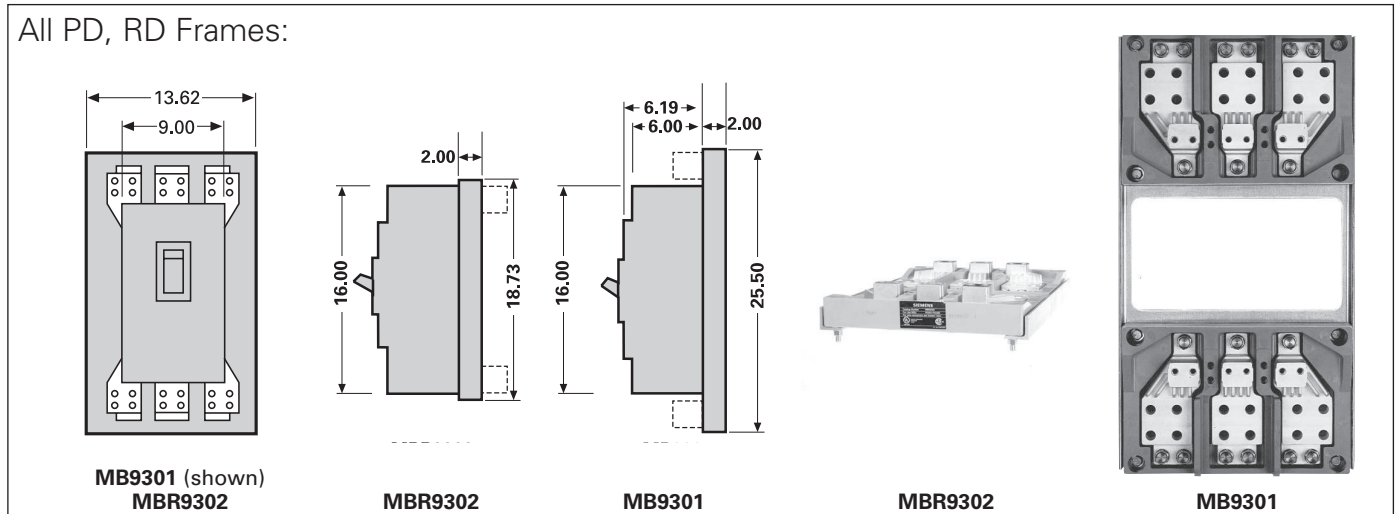

For inches / millimeters conversion, see Technical Data section.

Note: "G" suffix in catalog number denotes circuit breaker for 3-phase, 3-wire circuits. For 3-phase, 4-wire, order correct 4th wire (neutral) transformer as separate and additional item.

All breakers built to order. Allow 2-3 weeks for delivery.
^① For additional information, see **Note: A**, page 5-147.
^② The PD frame circuit breaker requires the use of a connect-all mounting assembly to allow for placing into service.

^③ Advanced trip unit equipped with DAS / Maintenance Mode. Requires customer-supplied 24V external power supply, maintenance switch and light.

Molded Case Circuit Breakers

Internal Accessories

Selection/Dimensions

Accessories for:

MD/SMD 800A Frame
ND/SND 1200A Frame
PD/SPD 1600A Frame
RD 2000A Frame



Accessory modules can mount in either left hand or right hand poles of all circuit breakers, including solid state. Exception: when mechanical interlock is used accessories cannot be mounted in left pole.

Shunt Trip Combinations

Control Voltage		1 Shunt Trip	1 Shunt Trip and 1 Auxiliary Switch
AC	DC	Catalogue Number	Catalogue Number
120	—	S01MN6	S01MN64A
208	—	S02MN6	S02MN64A
240	—	S03MN6	S03MN64A
277	—	S15MN6	S15MN64A
480	—	S04MN6	S04MN64A
600	—	S06MN6	—
—	12	S16MN6	S16MN64A
—	24	S07MN6	S07MN64A
—	48	S09MN6	—
—	125	S11MN6	S11MN64A
—	250	S13MN6	S13MN64A

Undervoltage Trip Combinations

Control Voltage		1 Undervoltage Trip	1 Undervoltage Trip and 1 Auxiliary Switch	1 Undervoltage Trip and 2 Auxiliary Switches
AC	DC	Catalogue Number	Catalogue Number	Catalogue Number
120	—	U01MN6	U01MN64A	U01MN64AA
208	—	U02MN6	U02MN64A	U02MN64AA
240	—	U03MN6	U03MN64A	U03MN64AA
277	—	U15MN6	U15MN64A	U15MN64AA
480	—	U04MN6	U04MN64A	U04MN64AA
600	—	U06MN6	—	—
—	24	U07MN6	U07MN64A	U07MN64AA
—	48	U09MN6	U09MN64A	U09MN64AA
—	125	U11MN6	U11MN64A	U11MN64AA1
—	250	U13MN6	U13MN64A	U13MN64AA

Auxiliary Switch Combinations

Maximum Voltage		1 Form C*	2 Form C
AC	DC	Catalogue Number	Catalogue Number
480	250	A01MN64	A02MN64
—	12	A01MNDLV	A02MNDLV

Alarm Switch Combinations

Maximum Voltage		1 Alarm Switch	1 Alarm Switch and 1 Auxiliary Switch	1 Alarm Switch and 2 Auxiliary Switches
AC	DC	Catalogue Number	Catalogue Number	Catalogue Number
480	250	B00MN64	A01MN64B	A02MN64B

ETU Testing Unit

Breaker Type	Description	Catalogue Number
SJD, SLD, SMD, SND, SPD	Power Stick	EPSP18V
	Spare cable for Power Stick	COMPCA

The EPSP18V Power Stick is a hand-held, battery-operated power supply that can be used for trip testing the Sensitrip IV electronic trip units. Requires two 9V batteries.

Molded Case Circuit Breakers

RD 2000A Frame Sentron Series

Selection

Type RXD6^④

3-Pole 600V AC, 250-500V DC^①

Blue Label

Non-Interchangeable Trip (Assembled Circuit Breaker Only Without Lugs)			
Continuous Current Rating @ 40°C	Complete Breaker Assembled (Frame/Trip Unit Only) Catalogue Number	Mounting Assembly Catalogue Number	Lugs (6 required) Catalogue Number
1600	RXD63B160	MB9301	TC5R600
1800	RXD63B180	-or-	
2000	RXD63B200	MBR9302	

Type RD6^④

3-Pole 600V AC, 250-500V DC^①

Blue Label

Interchangeable Trip (Unassembled Circuit Breaker with Lugs)					
Continuous Current Rating @ 40°C	Complete Breaker Unassembled Catalogue Number	Frame Only Catalogue Number	Trip Unit Only Catalogue Number	Mounting Assembly Catalogue Number	Lugs (6 required) Catalogue Number
1600	RD63B160	RD63F200	RD63T160	MB9301	TC5R600
1800	RD63B180		RD63T180	-or-	
2000	RD63B200		RD63T200	MBR9302	

Type HRXD6^④

Continuous Current Rating @ 40°C	Complete Breaker Assembled (Frame/Trip Unit Only)	
	Catalogue Number	
1600	HRXD63B160	
1800	HRXD63B180	
2000	HRXD63B200	

Type HRD6^④

Black Label

Continuous Current Rating @ 40°C	Complete Breaker Unassembled Catalogue Number	Frame Only Catalogue Number	Trip Unit Only Catalogue Number	Mounting Assembly Catalogue Number	Lugs (6 required) Catalogue Number
1600	HRD63B160	HRD63F200	RD63T160	MB9301	TC5R600
1800	HRD63B180		RD63T180	-or-	
2000	HRD63B200		RD63T200	MBR9302	

Interrupting Ratings

Breaker Type	CSA 22.2 No. 5 / UL 489 A IR					
	RMS Symmetrical KA					
	Volts AC			Volts DC ^①		
	240	480	600	250	500	
RD6, RXD6	65	50	25	30 (2P)	25 (3P)	
HRD6, HRXD6	100	65	50	30 (2P)	50 (3P)	

Instantaneous Adjustment Trip Range (PD / RD Frames)

Breaker Ampere Rating	Nominal Instantaneous Values							
	±25% Tolerance Low	2	3	4	5	6	7	±20% Tolerance High
1200-2000	5000	5715	6430	7145	7860	8575	9790	10,000

① Use two outside poles of a 3-pole circuit breaker for 250V DC applications.

② When wired as shown on page 5-4, this circuit breaker is CSA Certified / UL Listed and rated for use on 500V DC ungrounded UPS systems only.

③ RXD6 and HRXD6 type circuit breakers are CSA Certified / UL Listed for reverse feed applications.

④ HACR rated.



RXD63B200

Mounting Block^⑥

Catalogue Number	Connection Points
MB9301	Front
MBR9302	Rear

Shipping Weights

Number of Poles	Number per Carton	Shipping Weight (lbs.)
PXD6, HPXD6, RXD6, HRXD6, CPD6 Assembled Breakers		
3	1	61.5
PD6, HPD6, RD6, HRD6 Frame Only		
3	1	55.0
PD6, RD6 Trip Unit Only		
3	1	6.5
Mounting Assembly		
MB9301	1	53.0
MBR9302	1	50.9

Lugs (6 required per breaker)^⑤

Catalogue Number	No of Cables per Connector	Wire Range
TA5P600	1-5	300-600 kcmil Cu/Al
TC5R600	1-5	300-600 kcmil Cu only
TA6R600	1-6	300-600 kcmil Cu/Al

⑤ For additional information See **Note: A**, page 5-147.

Note: RD frame qualified to UL489 supplement B "NAVAL". See page 5-150 for additional information.

⑥ For required mounting base (MB9301 or MBR9302) see page 5-117.

Molded Case Circuit Breakers

Magnetic Trip Only — ETI Motor Circuit Protector

Selection

Breaker Type	Ampere Rating	Instantaneous Trip Range ^②		Complete Circuit Breaker Without Lugs ^⑤		
		Minimum ^③	Maximum ^③	Catalogue Number 2-Pole	Catalogue Number 3-Pole	
HEM	3	9	33	—	HEM3M003L	
	7	21	77	—	HEM3M007L	
	15	45	165	—	HEM3M015L	
	30	90	330	—	HEM3M030L	
	50	150	550	—	HEM3M050L	
	70	210	770	—	HEM3M070L	
	100	300	1100	—	HEM3M100L	
	SHIPPING:					3.7 lbs. each
ED6-A 600V AC 250V DC	1	2.6	9	—	ED63A001	
	2	7	22	—	ED63A002	
	3	10	35	—	ED63A003	
	5	16	54	—	ED63A005	
	10	30	100	—	ED63A010	
	25	55	180	—	ED63A025	
	30	80	270	—	ED63A030	
	40	115	375	—	ED63A040	
	50	180	600	—	ED63A050	
	100	315	1000	—	ED63A100	
	125	500	1250	—	ED63A125	
	SHIPPING:					3.8 lbs. each
	CED6-A 600V AC 250V DC	1	2.6	9	—	CED63A001
2		7	22	—	CED63A002	
3		10	35	—	CED63A003	
5		16	54	—	CED63A005	
10		30	100	—	CED63A010	
25		55	180	—	CED63A025	
30		80	270	—	CED63A030	
40		115	375	—	CED63A040	
50		180	600	—	CED63A050	
100		315	1000	—	CED63A100	
125		500	1250	—	CED63A125	
SHIPPING:					6 lbs. each	
FXD6^④ 600V AC 250V DC		150	400	800	—	FXD63L150
	150	800	1500	—	FXD63A150	
	150	1100	2500	—	FXD63H150	
	250	1100	2500	—	FXD63A250	
	SHIPPING:					9 lbs. each
CFD6^④ 600V AC 250V DC	150	400	800	—	CFD63L150	
	150	800	1500	—	CFD63A150	
	150	1100	2500	—	CFD63H150	
	250	1100	2500	—	CFD63A250	
	SHIPPING:					12 lbs. each
JXD6(A)^① 600V AC 250V DC	400	1250	2500	—	JXD63L400	
	400	2000	4000	JXD62H400	JXD63H400	
	SHIPPING:					16 lbs. each
CJD6^① 600V AC 250V DC	400	1250	2500	—	CJD63L400	
	400	2000	4000	—	CJD63H400	
	SHIPPING:					29.5 lbs. each
LXD6(A)^① 600V AC 250V DC	600	2000	4000	LXD62L600	LXD63L600	
	600	3000	6000	—	LXD63H600	
	SHIPPING:					16 lbs. each
CLD6^① 600V AC 250V DC	600	2000	4000	—	CLD63L600	
	600	3000	6000	—	CLD63H600	
	SHIPPING:					31.5 lbs. each
LMXD6^④ 600V AC 250V DC	800	2800	6000	—	LMXD63L800	
	800	3200	8000	—	LMXD63A800	
	SHIPPING:					35 lbs. each
MXD6^④ 600V AC 250V DC	800	3000	6000	—	MXD63L800	
	800	4000	8000	—	MXD63A800	
	800	5000	10000	—	MXD63H800	
	SHIPPING:					33 lbs. each
CMD6^④ 600V AC 250V DC	800	3000	6000	—	CMD63L800	
	800	4000	8000	—	CMD63A800	
	800	5000	10000	—	CMD63H800	
	SHIPPING:					80 lbs. each

Important Information

ETI interrupting ratings are determined through combination tests with properly sized overload relays and contactors.

⑤ Connectors included when ordering by circuit breaker catalog number for HEM, ED and CED6 ETIs. Order ETI circuit breaker and lugs (2 per pole) separately for the FXD6, CFD6, MXD6, CMD6, JXD6, CJD6, LXD6 and CLD6 ETI's.

① 2-pole available in 3-pole width only.

② When applied on DC Circuits — Trip levels will increase approximately +15 to 20%.

③ Tolerance -20%/+30% for lowest setting. All other settings are -20%/+20%

④ For 2-pole application use outside poles of 3-pole circuit breaker.

Lug Information pages 5-147 - 5-149
Enclosures page 5-139 - 5-146
Accessories pages 5-151 - 5-159

Molded Case Circuit Breakers

Motor Circuits

Application

General

Protection of Motor Circuits

Molded case circuit breakers are used in motor circuits as a disconnecting means and for short-circuit protection. They should be used in conjunction with motor-running, over-current-protection devices, and should permit the motor to start without nuisance tripping from motor-inrush current. The circuit breaker should have a continuous-current rating of not less than 115% of the motor full-load current.

The recommended motor circuit protectors (Siemens ETI instantaneous only circuit breakers) listed have

continuous-current ratings of at least 115% of motor full-load currents. The trip-setting positions are approximately 11 times motor full-load currents. The suggested trip settings may have to be adjusted upward to no higher than 1300% of full-load current for non-design E type motors, and no greater than 1700% of full load current for design B & E energy efficient motors, to allow for motor start-up due to inrush currents.

Breaker Mounted Immediately Ahead of Motor Starter

Siemens ETI motor circuit protectors are recommended for use in combination motor starters to provide selective short-circuit protection for the motor branch

circuit. The adjustable instantaneous-trip feature of the Siemens ETI motor circuit protector provides for a trip setting slightly above the peak motor-inrush current. With this setting, no delay is introduced in opening the circuit when a fault occurs. This circuit breaker has no time-delay trip element. Therefore it must be used in conjunction with, and immediately ahead of, the motor-running overcurrent protective device.

Important: The information below does not apply to all motor applications: it is recommended that the user refer to the National Electrical Code (NEC) for specific needs.

Table 1 (When Breaker is Mounted Immediately Ahead of Motor Starter)

3 Phase Induction Type Motors (Siemens ETI motor circuit protectors for branch circuit use with alternating-current combination, full voltage motor starters).

Motor Full Load Amperes	Catalogue Number	ETI Trip Setting	
		Adjustment	Amperes
.20 – .33	ED63A001 CED63A001	Low	2.6
.34 – .45		2	4.5
.46 – .56		3	6
.57 – .68		4	7.5
.69 – .81		High	9
.53 – .83	ED63A002 CED63A002	Low	7
.84 – 1.14		2	11
1.15 – 1.45		3	15
1.46 – 1.68		4	19
1.69 – 2.00		High	22
.76 – 1.29	ED63A003 CED63A003	Low	10
1.30 – 1.75		2	17
1.76 – 2.29		3	23
2.30 – 2.68		4	30
2.69 – 3.18		High	35
1.23 – 1.99	ED63A005 CED63A005	Low	16
2.00 – 2.75		2	26
2.76 – 3.52		3	36
3.53 – 4.14		4	46
4.15 – 4.90		High	54
2.30 – 3.83	ED63A010 CED63A010	Low	30
3.84 – 5.37		2	50
5.38 – 6.52		3	70
6.53 – 7.68		4	85
7.69 – 9.10		High	100
4.23 – 6.91	ED63A025 CED63A025	Low	55
6.92 – 9.61		2	90
9.62 – 11.91		3	125
11.92 – 13.83		4	155
13.84 – 16.40		High	180
6.15 – 10.37	ED63A030 CED63A030	Low	80
10.38 – 14.22		2	135
14.23 – 18.06		3	185
18.07 – 20.75		4	235
20.76 – 24.50		High	270
8.84 – 14.22	ED63A040 CED63A040	Low	115
14.23 – 19.60		2	185
19.61 – 24.99		3	255
25.00 – 28.83		4	325
28.84 – 34.00		High	375
13.84 – 23.06	ED63A050 CED63A050	Low	180
23.07 – 31.52		2	300
31.53 – 39.99		3	410
40.00 – 46.14		4	520
46.15 – 54.50		High	600
24.23 – 41.52	ED63A100 CED63A100	Low	315
41.53 – 56.91		2	540
56.92 – 68.45		3	740
68.46 – 76.91		4	890
76.92 – 90.90		High	1000

Motor Full Load Ampres	Catalogue Number	ETI Trip Setting	
		Adjustment	Amperes
38.46 – 55.37	ED63A125 CED63A125	Low	500
55.38 – 70.75		2	720
70.76 – 84.60		3	920
84.61 – 96.14		4	1100
96.15 – 113.60		High	1250
30.76 – 35.37	FXD63L150 CFD63L150	Low	400
35.38 – 39.99		2	460
44.51 – 49.23		4	580
53.84 – 58.45		6	700
58.46 – 63.06		7	760
63.07 – 74.50	High	820	
61.53 – 69.22	FXD63A150 CFD63A150	Low	800
69.23 – 76.91		2	900
84.61 – 92.29		4	1100
100.00 – 108.00		6	1300
108.00 – 115.00		7	1400
115.00 – 136.00	High	1500	
85.00 – 100.00	FXD63A250 CFD63A250	Low	1100
100.00 – 115.00		2	1300
131.00 – 146.00		4	1700
162.00 – 177.00		6	2100
177.00 – 192.00		7	2300
192.00 – 227.00	High	2500	
95.00 – 110.00	JXD63L400 CJD63L400	Low	1250
110.00 – 124.00		2	1430
138.00 – 151.00		4	1790
165.00 – 178.00		6	2140
178.00 – 192.00		7	2320
192.00 – 227.00	High	2500	
154.00 – 176.00	JXD63H400 CJD63H400	Low	2000
176.00 – 198.00		2	2290
220.00 – 242.00		4	2860
264.00 – 285.00		6	3430
285.00 – 308.00		7	3710
308.00 – 326.00	High	4000	
155.00 – 176.00	LXD63L600 CLD63L600	Low	2000
176.00 – 198.00		2	2290
220.00 – 242.00		4	2860
264.00 – 285.00		6	3430
285.00 – 308.00		7	3710
308.00 – 326.00	High	4000	

Motor Full Load Ampres	Catalogue Number	ETI Trip Setting	
		Adjustment	Amperes
231.00 – 264.00	LXD63H600 CLD63H600	Low	3000
264.00 – 292.00		2	3430
330.00 – 362.00		4	4290
395.00 – 428.00		6	5140
428.99 – 462.00		7	5570
462.00 – 490.00		High	6000
215.00 – 238.00		LFXD63L800	Low
238.00 – 261.00	2		3100
261.00 – 284.00	3		3400
308.00 – 369.00	5		4000
369.00 – 423.00	6		4800
423.00 – 462.00	7		5500
462.00 – 490.00	High		6000
246.00 – 269.00	LFXD63A800	Low	3200
269.00 – 284.00		2	3500
284.00 – 323.00		3	3700
362.00 – 492.00		5	4700
492.00 – 562.00		6	6400
562.00 – 616.00		7	7300
616.00 – 660.00		High	8000
231.00 – 264.00	MXD63L800 CMD63L800	Low	3000
264.00 – 292.00		2	3430
292.00 – 330.00		3	3800
362.00 – 395.00		5	4710
428.00 – 462.00		7	5570
462.00 – 490.00		High	6000
308.00 – 352.00		MXD63A800 CMD63A800	Low
352.00 – 442.00	2		4570
442.00 – 447.00	3		5740
483.00 – 527.00	5		6280
571.00 – 616.00	7		7240
616.00 – 660.00	High		8000
385.00 – 440.00	MXD63H800 CMD63H800		Low
495.00 – 550.00		3	6430
605.00 – 660.00		5	7860
660.00 – 695.00		6	8575

Note: Lowest instantaneous settings have a -20%/+30% tolerance and all other settings have a -20%/+20% tolerance.

Molded Case Circuit Breakers

Motor Circuits

Application

Breaker Mounted at a Distance From Motor Starter

ET thermal-magnetic circuit breakers conform to the National Electrical Code (2002) table 430-52 requirements for motor branch and feeder circuit protection when properly applied in conjunction with motor-running overcurrent protective devices. The

recommended circuit-breaker ratings in Table 2 provide adequate time delay for starting the majority of three-phase induction motors.

To determine the ampere ratings of the ET breaker to protect a motor feeder, add the rating of the ET breaker used to protect the largest motor branch circuit in the group to the full-load currents of

the remaining motors in the group.

Interrupt Ratings

For normal commercial purposes, available fault current can conveniently be obtained in the Interrupting Selector Tables.

Table 2 (When Breaker is Mounted at a Distance From Motor Starter)

3 Phase Induction Type Motors (EQ and ET circuit breakers (thermal-magnetic trip) for branch breaker use with alternating-current combination motor starters).

Motor Horse - power Rating	200 and 208V Motors			230V Motors			460V Motors			575V Motors		
	240V Circuit Breaker Data ^①			240V Circuit Breaker Data ^①			480V Circuit Breaker Data ^①			600V Circuit Breaker Data ^①		
	Breaker Type	Catalogue Number	Ampere Rating	Breaker Type	Catalogue Number	Ampere Rating	Breaker Type	Catalogue Number	Ampere Rating	Breaker Type	Catalogue Number	Ampere Rating
1/2	BQ ^②	BQ3B015	15	BQ ^②	BQ3B015	15	ED4	ED43B015	15	ED6	ED63B015	15
3/4		BQ3B015	15		BQ3B015	15		ED43B015	15		ED63B015	15
1		BQ3B015	15		BQ3B015	15		ED43B015	15		ED63B015	15
1 1/2		BQ3B015	15		BQ3B015	15		ED43B015	15		ED63B015	15
2		BQ3B020	20		BQ3B015	15		ED43B015	15		ED63B015	15
3		BQ3B030	30		BQ3B020	20		ED43B015	15		ED63B015	15
5	BQ ^②	BQ3B040	40	BQ ^②	BQ3B030	30	ED4	ED43B015	15	ED6	ED63B015	15
7 1/2		BQ3B060	60		BQ3B050	50		ED43B030	30		ED63B020	20
10		BQ3B070	70		BQ3B070	70		ED43B030	30		ED63B030	30
15		BQ3B100	100		BQ3B090	90		ED43B040	40		ED63B035	35
20					BQ3B100	100		ED43B050	50		ED63B050	50
25	FXD6	FXD63B125	125	FXD6	FXD63B125	125	FXD6	FXD63B090	90	FXD6	FXD63B060	60
30		FXD63B150	150		FXD63B150	150		FXD63B100	100		FXD63B070	70
40		FXD63B175	175		FXD63B175	175		FXD63B125	125		FXD63B090	90
50		FXD63B200	200		FXD63B200	200		FXD63B150	150		FXD63B100	100
		FXD63B225	225									
60	JXD2	JXD23B300	300	—	—	—	FXD6, FD6	FXD63B150	150	FXD6	FXD63B100	100
75	JXD2	JXD23B400	400	JXD2	JXD23B350	350	FXD6, FD6	FXD63B200	200	FXD6, FD6	FXD63B125	125
100	JXD2	JXD23B400	400	JXD2	JXD23B400	400	FD6 ^③ JD6 ^③	FD63B250 JD63B250	250 250	FXD6, FD6	FD63B175	175
125	LD6 ^③ or LMD6	LD63B600 LMD63B600	600	LD6 ^③ or LMD6	LD63B500 or LMD63B500	500	JD6 ^③	JD63B300	300	FXD6, FD6 OR JD6 ^③	FXD63B200 JD63B200	200 200
150	LD6 ^③ or LMD6	LD63B600 or LMD63B600	600	LMD6	LD63B600 or LMD63B600	600	JD6 ^③	JD63B300	300	FXD6 or JD6 ^③	FXD63B225 JD63B225	225 225
200	LMD6	LMD63B800	800	LMD6	LMD63B800	800	JD6 ^③ JD6 ^③	JD63B350 JD63B400	350 400	JD6 ^③ JD6 ^③	JD63B300 JD63B400	300 400
250	—	—	—	—	—	—	LD6 ^③ or	LD63B600 or	600	LD6 ^③ or	LD63B500 or	500
300	—	—	—	—	—	—	LMD6	LMD63B600	700	LMD6	LMD63B500	500
350	—	—	—	—	—	—	LMD6	LMD63B700	800	LD6 ^③ or	LD63B600 or	600
400	—	—	—	—	—	—	LMD6	LMD63B800	—	LMD6	LMD63B600	600
500	—	—	—	—	—	—	—	—	—	LMD6	LMD63B800	800

①The selection of breakers for this table is in accordance with Article 430, 2002 National Electric Code. The Canadian electrical code should also be referred to for rating information. Recommended circuit breakers are for full voltage starting, special consideration is necessary for reduced voltage starting.

②For panelboard applications, substitute the BL breaker for the BQ, ED2 circuit breakers may also be used.

③For non-interchangeable trip applications, substitute the FXD6 for the FD6, the JXD6 for the JD6, or the LXD6 for the LD6.

Molded Case Circuit Breakers

Adjustable Instantaneous Magnetic Trip Settings

Application

Breaker Type	Maximum Continuous Amperes	Nominal AC Adjustable Trip Range								ETI Motor Circuit Protector Catalogue Number	Thermal Magnetic Catalogue Number		
		Low	2	3	4	5	6	7	High		3-Pole	2-Pole	3-Pole
HEM	3	9	15	21	27	30	—	—	33	HEM3M003L	—	—	
	7	21	35	49	63	70	—	—	77	HEM3M007L	—	—	
	15	45	75	100	135	150	—	—	165	HEM3M015L	—	—	
	30	90	150	210	270	300	—	—	330	HEM3M030L	—	—	
	50	150	250	350	450	500	—	—	550	HEM3M050L	—	—	
	70	210	350	490	630	700	—	—	770	HEM3M070L	—	—	
	100	300	500	700	900	1000	—	—	1100	HEM3M100L	—	—	
ED6	1	2.6	4.5	6	7.5	—	—	—	9	ED63A001	—	—	
	2	7	11	15	19	—	—	—	22	ED63A002	—	—	
	3	10	17	23	30	—	—	—	35	ED63A003	—	—	
	5	16	26	36	46	—	—	—	54	ED63A005	—	—	
	10	30	50	70	85	—	—	—	100	ED63A010	—	—	
	25	55	90	125	155	—	—	—	180	ED63A025	—	—	
	30	80	135	185	235	—	—	—	270	ED63A030	—	—	
	40	115	185	255	325	—	—	—	375	ED63A040	—	—	
	50	180	300	410	520	—	—	—	600	ED63A050	—	—	
	100	315	540	740	890	—	—	—	1000	ED63A100	—	—	
	125	500	720	920	1100	—	—	—	1250	ED63A125	—	—	
	CED6	1	2.6	4.5	6	7.5	—	—	—	9	CED63A001	—	—
		2	7	11	15	19	—	—	—	22	CED63A002	—	—
3		10	17	23	30	—	—	—	35	CED63A003	—	—	
5		16	26	36	46	—	—	—	54	CED63A005	—	—	
10		30	50	70	85	—	—	—	100	CED63A010	—	—	
25		55	90	125	155	—	—	—	180	CED63A025	—	—	
30		80	135	185	235	—	—	—	270	CED63A030	—	—	
40		115	185	255	325	—	—	—	375	CED63A040	—	—	
50		180	300	410	520	—	—	—	600	CED63A050	—	—	
100		315	540	740	890	—	—	—	1000	CED63A100	—	—	
125		500	720	920	1100	—	—	—	1250	CED63A125	—	—	
FXD6-A		70	600	640	690	730	770	810	850	900	—	FXD62B070	FXD63B070
		80	600	640	690	730	770	810	850	900	—	FXD62B080	FXD63B080
	90	600	640	690	730	770	810	850	900	—	FXD62B090	FXD63B090	
	100	700	770	840	920	990	1060	1140	1200	—	FXD62B100	FXD63B100	
	110	700	770	840	920	990	1060	1140	1200	—	FXD62B110	FXD63B110	
	125	800	900	1000	1100	1200	1300	1400	1500	—	FXD62B125	FXD63B125	
	150	400	460	520	580	640	700	760	820	FXD63L150	—	—	
	150	800	900	1000	1100	1200	1300	1400	1500	FXD63A150	FXD62B150	FXD63B150	
	150	1100	1300	1500	1700	1900	2100	2300	2500	FXD63H150	—	—	
	175	900	1060	1210	1370	1520	1780	1930	2000	—	FXD62B175	FXD63B175	
	200	900	1060	1210	1370	1520	1780	1930	2000	—	FXD62B200	FXD63B200	
	225	1100	1300	1500	1700	1900	2100	2300	2500	—	FXD62B225	FXD63B225	
	250	1100	1300	1500	1700	1900	2100	2300	2500	FXD63A250	FXD62B250	FXD63B250	
FD6-A	70	600	640	690	730	770	810	850	900	—	FD62B070	FD63B070	
	80	600	640	690	730	770	810	850	900	—	FD62B080	FD63B080	
	90	600	640	690	730	770	810	850	900	—	FD62B090	FD63B090	
	100	700	770	840	920	990	1060	1140	1200	—	FD62B100	FD63B100	
	110	700	770	840	920	990	1060	1140	1200	—	FD62B110	FD63B110	
	125	800	900	1000	1100	1200	1300	1400	1500	—	FD62B125	FD63B125	
	150	800	900	1000	1100	1200	1300	1400	1500	—	FD62B150	FD63B150	
	175	900	1060	1210	1370	1520	1780	1930	2000	—	FD62B175	FD63B175	
	200	900	1060	1210	1370	1520	1780	1930	2000	—	FD62B200	FD63B200	
	225	1100	1300	1500	1700	1900	2100	2300	2500	—	FD62B225	FD63B225	
	250	1100	1300	1500	1700	1900	2100	2300	2500	—	FD62B250	FD63B250	
	HFD6	70	600	640	690	730	770	810	850	900	—	HFD62B070	HFD63B070
		80	600	640	690	730	770	810	850	900	—	HFD62B080	HFD63B080
90		600	640	690	730	770	810	850	900	—	HFD62B090	HFD63B090	
100		700	770	840	920	990	1060	1140	1200	—	HFD62B100	HFD63B100	
110		700	770	840	920	990	1060	1140	1200	—	HFD62B110	HFD63B110	
125		800	900	1000	1100	1200	1300	1400	1500	—	HFD62B125	HFD63B125	
150		800	900	1000	1100	1200	1300	1400	1500	—	HFD62B150	HFD63B150	
175		900	1060	1210	1370	1520	1780	1930	2000	—	HFD62B175	HFD63B175	
200		900	1060	1210	1370	1520	1780	1930	2000	—	HFD62B200	HFD63B200	
225		1100	1300	1500	1700	1900	2100	2300	2500	—	HFD62B225	HFD63B225	
250		1100	1300	1500	1700	1900	2100	2300	2500	—	HFD62B250	HFD63B250	
HHFD6		70	600	640	690	730	770	810	850	900	—	—	HHFD63B070
		80	600	640	690	730	770	810	850	900	—	—	HHFD63B080
	90	600	640	690	730	770	810	850	900	—	—	HHFD63B090	
	100	700	770	840	920	990	1060	1140	1200	—	—	HHFD63B100	
	110	700	770	840	920	990	1060	1140	1200	—	—	HHFD63B110	
	125	800	900	1000	1100	1200	1300	1400	1500	—	—	HHFD63B125	
	150	800	900	1000	1100	1200	1300	1400	1500	—	—	HHFD63B150	
	175	900	1060	1210	1370	1520	1780	1930	2000	—	—	HHFD63B175	
	200	900	1060	1210	1370	1520	1780	1930	2000	—	—	HHFD63B200	
	225	1100	1300	1500	1700	1900	2100	2300	2500	—	—	HHFD63B225	
	250	1100	1300	1500	1700	1900	2100	2300	2500	—	—	HHFD63B250	
	CFD6	70	600	640	690	730	770	810	850	900	—	CFD62B070	CFD63B070
		80	600	640	690	730	770	810	850	900	—	CFD62B080	CFD63B080
90		600	640	690	730	770	810	850	900	—	CFD62B090	CFD63B090	
100		700	770	840	920	990	1060	1140	1200	—	CFD62B100	CFD63B100	
110		700	770	840	920	990	1060	1140	1200	—	CFD62B110	CFD63B110	
125		800	900	1000	1100	1200	1300	1400	1500	—	CFD62B125	CFD63B125	
150		400	460	520	580	640	700	760	820	CFD63L150	—	—	
150		800	900	1000	1100	1200	1300	1400	1500	CFD63A150	CFD62B150	CFD63B150	
150		1100	1300	1500	1700	1900	2100	2300	2500	CFD63H150	—	—	
175		900	1060	1210	1370	1520	1780	1930	2000	—	CFD62B175	CFD63B175	
200		900	1060	1210	1370	1520	1780	1930	2000	—	CFD62B200	CFD63B200	
225		1100	1300	1500	1700	1900	2100	2300	2500	—	CFD62B225	CFD63B225	
250		1100	1300	1500	1700	1900	2100	2300	2500	CFD63A250	CFD62B250	CFD63B250	

Note: Tolerances for instantaneous trip points meet CSA C22.2 NO.5 / UL 489(7.3). Nominal AC instantaneous trip points are given in the tables. For DC instantaneous trip points, add 15% to nominal values. Instantaneous trip

adjustment is made through the breaker cover on all frame breakers. To change instantaneous trip point on circuit breaker, depress indicating knob, then rotate to desired position.

Built to order. Allow 2-3 weeks for delivery.

Molded Case Circuit Breakers

Adjustable Instantaneous Magnetic Trip Settings

Application

Breaker Type	Maximum Continuous Amperes	Nominal AC Adjustable Trip Range								ETI Motor Circuit Protector Catalogue Number	Thermal Magnetic Catalogue Number		
		Low	2	3	4	5	6	7	High		3-Pole	2-Pole	3-Pole
JXD2(A)	200	1250	1430	1610	1790	1960	2140	2320	2500	—	JXD22B200	JXD23B200	
	225	1250	1430	1610	1790	1960	2140	2320	2500	—	JXD22B225	JXD23B225	
	250	1250	1430	1610	1790	1960	2140	2320	2500	—	JXD22B250	JXD23B250	
	300	1250	1430	1610	1790	1960	2140	2320	2500	—	JXD22B300	JXD23B300	
	350	2000	2290	2570	2860	3140	3430	3710	4000	—	JXD22B350	JXD23B350	
	400	2000	2290	2570	2860	3140	3430	3710	4000	—	JXD22B400	JXD23B400	
JXD6(A)	200	1250	1430	1610	1790	1960	2140	2320	2500	—	JXD62B200	JXD63B200	
	225	1250	1430	1610	1790	1960	2140	2320	2500	—	JXD62B225	JXD63B225	
	250	1250	1430	1610	1790	1960	2140	2320	2500	—	JXD62B250	JXD63B250	
	300	1250	1430	1610	1790	1960	2140	2320	2500	—	JXD62B300	JXD63B300	
	350	2000	2290	2570	2860	3140	3430	3710	4000	—	JXD62B350	JXD63B350	
	400	2000	2290	2570	2860	3140	3430	3710	4000	—	JXD62B400	JXD63B400	
JD6(A)	200	1250	1430	1610	1790	1960	2140	2320	2500	—	JD62B200	JD63B200	
	225	1250	1430	1610	1790	1960	2140	2320	2500	—	JD62B225	JD63B225	
	250	1250	1430	1610	1790	1960	2140	2320	2500	—	JD62B250	JD63B250	
	300	1250	1430	1610	1790	1960	2140	2320	2500	—	JD62B300	JD63B300	
	350	2000	2290	2570	2860	3140	3430	3710	4000	—	JD62B350	JD63B350	
	400	1250	1430	1610	1790	1960	2140	2320	2500	JXD63L400 JXD63H400	—	—	
HJD6(A)	200	1250	1430	1610	1790	1960	2140	2320	2500	—	HJD62B200	HJD63B200	
	225	1250	1430	1610	1790	1960	2140	2320	2500	—	HJD62B225	HJD63B225	
	250	1250	1430	1610	1790	1960	2140	2320	2500	—	HJD62B250	HJD63H250	
	300	1250	1430	1610	1790	1960	2140	2320	2500	—	HJD62B300	HJD63B300	
	350	2000	2290	2570	2860	3140	3430	3710	4000	—	HJD62B350	HJD63B350	
	400	2000	2290	2570	2860	3140	3430	3710	4000	—	HJD62H400	HJD63B400	
HHJD6	200	1250	1430	1610	1790	1960	2140	2320	2500	—	HHJD62B200	HHJD63B200	
	225	1250	1430	1610	1790	1960	2140	2320	2500	—	HHJD62B225	HHJD63B225	
	250	1250	1430	1610	1790	1960	2140	2320	2500	—	HHJD62B250	HHJD63B250	
	300	1250	1430	1610	1790	1960	2140	2320	2500	—	HHJD62B300	HHJD63B300	
	350	2000	2290	2570	2860	3140	3430	3710	4000	—	HHJD62B350	HHJD63B350	
	400	2000	2290	2570	2860	3140	3430	3710	4000	—	HHJD62B400	HHJD63B400	
CJD6	200	1250	1430	1610	1790	1960	2140	2320	2500	—	—	CJD63B200	
	225	1250	1430	1610	1790	1960	2140	2320	2500	—	—	CJD63B225	
	250	1250	1430	1610	1790	1960	2140	2320	2500	—	—	CJD63B250	
	300	1250	1430	1610	1790	1960	2140	2320	2500	—	—	CJD63B300	
	350	2000	2290	2570	2860	3140	3430	3710	4000	—	—	CJD63B350	
	400	1250	1450	1610	1790	1960	2140	2320	2500	CJD63H400 CJD63L400	—	CHD63B400	
LXD6(A)	450	2000	2290	2570	2860	3140	3430	3710	4000	—	LXD62B450	LXD63B450	
	500	3000	3430	3860	4290	4710	5140	5570	6000	—	LXD62B500	LXD63B500	
	600	3000	3430	3860	4290	4710	5140	5570	6000	—	LXD62B600	LXD63B600	
LD6(A)	250	1250	1430	1610	1790	1960	2140	2320	2500	—	LD62B250	LD63B250	
	300	1250	1430	1610	1790	1960	2140	2320	2500	—	LD62B300	LD63B300	
	350	2000	2290	2570	2860	3140	3430	3710	4000	—	LD62B350	LD63B350	
	400	2000	2290	2570	2860	3140	3430	3710	4000	—	LD62B400	LD63B400	
	450	2000	2290	2570	2860	3140	3430	3710	4000	—	LD62B450	LD63B450	
	500	3000	3430	3800	4290	4710	5140	5570	6000	—	LD62B500	LD63B500	
HLD6(A)	250	1250	1430	1610	1790	1960	2140	2320	2500	—	HLD62B250	HLD63B250	
	300	1250	1430	1610	1790	1960	2140	2320	2500	—	HLD62B300	HLD63B300	
	350	2000	2290	2570	2860	3140	3430	3710	4000	—	HLD62B350	HLD63B350	
	400	2000	2290	2570	2860	3140	3430	3710	4000	—	HLD62B400	HLD63B400	
	450	2000	2290	2570	2860	3140	3430	3710	4000	—	HLD62B450	HLD63B450	
	500	3000	3430	3860	4290	4710	5140	5570	6000	—	HLD62B500	HLD63B500	
HHL6	250	1250	1430	1610	1790	1960	2140	2320	2500	—	HHL62B250	HHL63B250	
	300	1250	1430	1610	1790	1960	2140	2320	2500	—	HHL62B300	HHL63B300	
	350	2000	2290	2570	2860	3140	3430	3710	4000	—	HHL62B350	HHL63B350	
	400	2000	2290	2570	2860	3140	3430	3710	4000	—	HHL62B400	HHL63B400	
	450	2000	2290	2570	2860	3140	3430	3710	4000	—	HHL62B450	HHL63B450	
	500	3000	3430	3860	4290	4710	5140	5570	6000	—	HHL62B500	HHL63B500	
CLD6	250	1250	1430	1610	1790	1960	2140	2320	2500	—	—	CLD63B250	
	300	1250	1430	1610	1790	1960	2140	2320	2500	—	—	CLD63B300	
	350	2000	2290	2570	2860	3140	3430	3710	4000	—	—	CLD63B350	
	400	2000	2290	2570	2860	3140	3430	3710	4000	—	—	CLD63B400	
	450	2000	2290	2570	2860	3140	3430	3710	4000	—	—	CLD63B450	
	500	3000	3430	3860	4290	4710	5140	5570	6000	—	—	CLD63B500	
LMXD6	500	3000	3430	3860	4290	4710	5140	5570	6000	—	—	LMXD63B500	
	600	3000	3430	3860	4290	4710	5140	5570	6000	—	—	LMXD63B600	
	700	3200	3500	3700	4200	4700	6400	7300	8000	—	LMXD62B700	LMXD63B700	
	800	2800	3100	3400	3700	4000	4800	5500	6000	—	—	—	
	800	3200	3500	3700	4200	4700	6400	7300	8000	LMXD63L800 LMXD63A800	LMXD62B800	LMXD63B800	
	LMD6	500	3000	3430	3860	4290	4710	5140	5570	6000	—	LMD62B500	LMD63B500
600		3000	3430	3860	4290	4710	5140	5570	6000	—	LMD62B600	LMD63B600	
700		3200	3500	3700	4200	4700	6400	7300	8000	—	LMD62B700	LMD63B700	
800		3200	3500	3700	4200	4700	6400	7300	8000	—	LMD62B800	LMD63B800	

5
MOLDED CASE
CIRCUIT BREAKERS

Molded Case Circuit Breakers

Adjustable Instantaneous Magnetic Trip Settings

Application

Breaker Type	Maximum Continuous Amperes	Nominal AC Adjustable Trip Range								ETI Motor Circuit Protector Catalogue Number	Thermal Magnetic Catalogue Number		
		Low	2	3	4	5	6	7	High	3-Pole	2-Pole	3-Pole	
HLMXD6	500	3000	3430	3860	4290	4710	5140	5570	6000	—	—	HLMXD63B500	
	600	3000	3430	3860	4290	4710	5140	5570	6000	—	—	HLMXD63B600	
	700	3200	3500	3700	4200	4700	6400	7300	8000	—	—	HLMXD63B700	
	800	3200	3500	3700	4200	4700	6400	7300	8000	—	—	HLMXD63B800	
HLMD6	500	3000	3430	3860	4290	4710	5140	5570	6000	—	HLMD62B500	HLMD63B500	
	600	3000	3430	3860	4290	4710	5140	5570	6000	—	HLMD62B600	HLMD63B600	
	700	3200	3500	3700	4200	4700	6400	7300	8000	—	HLMD62B700	HLMD63B700	
	800	3200	3500	3700	4200	4700	6400	7300	8000	—	HLMD62B800	HLMD63B800	
MD6	500	3000	3430	3860	4290	4710	5140	5570	6000	—	MD62B500	MD63B500	
	600	3000	3430	3860	4290	4710	5140	5570	6000	—	MD62B600	MD63B600	
	700	4000	4570	5140	5710	6280	6850	7420	8000	—	MD62B700	MD63B700	
	800	3000	3430	3860	4280	4710	5140	5570	6000	MXD63L800	—	—	
	800	4000	4570	5140	5710	6280	6850	7420	8000	MXD63A800	MD62B800	MD63B800	
	800	5000	5715	6430	7145	7860	8575	9290	10000	MXD63H800	—	—	
MXD6	500	3000	3430	3860	4280	4710	5140	5570	6000	—	MXD62B500	MXD63B500	
	600	3000	3430	3860	4280	4710	5140	5570	6000	—	MXD62B600	MXD63B600	
	700	4000	4570	5140	5710	6280	6850	7420	8000	—	MXD62B700	MXD63B700	
	800	3000	3430	3860	4280	4710	5140	5570	6000	MXD63L800	—	—	
	800	4000	4570	5140	5710	6280	6850	7420	8000	MXD63A800	MXD62B800	MXD63B800	
	800	5000	5715	6430	7145	7860	8575	9290	10000	MXD63H800	—	—	
HMD6	500	3000	3430	3860	4280	4710	5140	5570	6000	—	HMD62B500	HMD63B500	
	600	3000	3430	3860	4280	4710	5140	5570	6000	—	HMD62B600	HMD63B600	
	700	4000	4570	5140	5710	6280	6850	7420	8000	—	HMD62B700	HMD63B700	
	800	4000	4570	5140	5710	6280	6850	7420	8000	—	HMD62B800	HMD63B800	
HMXD6	500	3000	3430	3860	4280	4710	5140	5570	6000	—	—	HMXD63B500	
	600	3000	3430	3860	4280	4710	5140	5570	6000	—	—	HMXD63B600	
	700	4000	4570	5140	5710	6280	6850	7420	8000	—	—	HMXD63B700	
	800	4000	4570	5140	5710	6280	6850	7420	8000	—	—	HMXD63B800	
CMD6	400	3000	3430	3860	4280	4710	5140	5570	6000	—	—	CMD63B400	
	500	3000	3430	3860	4280	4710	5140	5570	6000	—	—	CMD63B500	
	600	3000	3430	3860	4280	4710	5140	5570	6000	—	—	CMD63B600	
	700	4000	4570	5140	5710	6280	6850	7420	8000	—	—	CMD63B700	
	800	3000	3430	3860	4280	4710	5140	5570	6000	CMD63L800	—	—	
	800	4000	4570	5140	5710	6280	6850	7420	8000	CMD63A800	—	CMD63B800	
800	5000	5715	6430	7145	7860	8575	9290	10000	CMD63H800	—	—		
ND6	800	4000	4570	5140	5710	6280	6850	7420	8000	—	ND62B800	ND63B800	
	900	5000	5715	6430	7145	7860	8575	9290	10000	—	ND62B900	ND63B900	
	1000	5000	5715	6430	7145	7860	8575	9290	10000	—	ND62B100	ND63B100	
	1200	5000	5715	6430	7145	7860	8575	9290	10000	—	ND62B120	ND63B120	
NXD6	900	5000	5715	6430	7145	7860	8575	9290	10000	—	NXD62B900	NXD63B900	
	1000	5000	5715	6430	7145	7860	8575	9290	10000	—	NXD62B100	NXD63B100	
	1200	5000	5715	6430	7145	7860	8575	9290	10000	—	NXD62B120	NXD63B120	
HND6	800	4000	4570	5140	5710	6280	6850	7420	8000	—	HND62B800	HND63B800	
	900	5000	5715	6430	7145	7860	8575	9290	10000	—	HND62B900	HND63B900	
	1000	5000	5715	6430	7145	7860	8575	9290	10000	—	HND62B100	HND63B100	
	1200	5000	5715	6430	7145	7860	8575	9290	10000	—	HND62B120	HND63B120	
HNXD6	900	5000	5715	6430	7145	7860	8575	9290	10000	—	—	HNXD63B900	
	1000	5000	5715	6430	7145	7860	8575	9290	10000	—	—	HNXD63B100	
	1200	5000	5715	6430	7145	7860	8575	9290	10000	—	—	HNXD63B120	
CND6	800	4000	4570	5140	5710	6280	6850	7420	8000	—	—	CND63B800	
	900	5000	5715	6430	7145	7860	8575	9290	10000	—	—	CND63B900	
	1000	5000	5715	6430	7145	7860	8575	9290	10000	—	—	CND63B100	
	1200	5000	5715	6430	7145	7860	8575	9290	10000	—	—	CND63B120	
PD6	1200	5000	5715	6430	7145	7860	8575	9290	10000	—	—	PD63B120	
	1400	5000	5715	6430	7145	7860	8575	9290	10000	—	—	PD63B140	
	1600	5000	5715	6430	7145	7860	8575	9290	10000	—	—	PD63B160	
PXD6	1200	5000	5715	6430	7145	7860	8575	9290	10000	—	—	PXD63B120	
	1400	5000	5715	6430	7145	7860	8575	9290	10000	—	—	PXD63B140	
	1600	5000	5715	6430	7145	7860	8575	9290	10000	—	—	PXD63B160	
HPD6	1200	5000	5715	6430	7145	7860	8575	9290	10000	—	—	HPD63B120	
	1400	5000	5715	6430	7145	7860	8575	9290	10000	—	—	HPD63B140	
	1600	5000	5715	6430	7145	7860	8575	9290	10000	—	—	HPD63B160	
HPXD6	1200	5000	5715	6430	7145	7860	8575	9290	10000	—	—	HPXD63B120	
	1400	5000	5715	6430	7145	7860	8575	9290	10000	—	—	HPXD63B140	
	1600	5000	5715	6430	7145	7860	8575	9290	10000	—	—	HPXD63B160	
CPD6	1200	5000	5715	6430	7145	7860	8575	9290	10000	—	—	CPD63B120	
	1400	5000	5715	6430	7145	7860	8575	9290	10000	—	—	CPD63B140	
	1600	5000	5715	6430	7145	7860	8575	9290	10000	—	—	CPD63B160	
RD6	1800	5000	5715	6430	7145	7860	8575	9290	10000	—	—	RD63B180	
	2000	5000	5715	6430	7145	7860	8575	9290	10000	—	—	RD63B200	
RXD6	1800	5000	5715	6430	7145	7860	8575	9290	10000	—	—	RXD63B180	
	2000	5000	5715	6430	7145	7860	8575	9290	10000	—	—	RXD63B200	
HRD6	1800	5000	5715	6430	7145	7860	8575	9290	10000	—	—	HRD63B180	
	2000	5000	5715	6430	7145	7860	8575	9290	10000	—	—	HRD63B200	

5
MOLDED CASE
CIRCUIT BREAKERS

Molded Case Circuit Breakers

Molded Case Switch — Circuit Disconnect

Selection

Maximum Frame Amp Rating	2-Pole	3-Pole	Self-Protective Instantaneous Override $\pm 20\%$ c
	Catalogue Number	Catalogue Number	
100	BQ2S060 BQ2S100	BQ3S060 BQ3S100	1000 1000
125	ED22S100A ED42S100A ED42S125A ED62S100A — CED62S100A CED62S125A	ED23S100A ED43S100A ED43S125A ED63S100A ED63S125A CED63S100A CED63S125A	1000 1000 1000 1000 1000 1000 1000
225	QJ22S225A	QJ23S225A	2000
250	FXD62S250A HFXD62S250A ①	FXD63S250A HFXD63S250A CFD63S250A	3200 3200 3200
400	JXD22S400A — — ①	JXD23S400A JXD63S400A HJXD63S400A CJD63S400A	6000 6000 6000 6000
600	— — ①	LXD63S600A HLXD63S600A CLD63S600A	6000 6000 6000
800	— — ①	LMXD63S800A MXD63S800A CMD63S800A	8000 8000 8000
1200	— ①	NXD63S120A CND63S120A	10000 10000
1600	①	PXD63S160A [®]	10000
2000	①	RXD63S200A [®]	10000

Ordering Information

Order by catalogue number. Switches include frame and self protective trip unit only. Order lugs separately from page 5-134 - 5-136.

① For 2-pole application use outside poles of 3-pole circuit breaker.

② For additional lugs see page 5-134.

③ Molded case switches up to R frame contain a self protecting instantaneous element, which may open circuit above their override set point.

④ Requires mounting block MB9301 or MBR9302.

Lugs pages 5-134 - 5-136
Accessories page 5-138 - 5-146

Molded Case Circuit Breakers

Digital Solid State Sentron Sensitrip IV Series

Technical

The Sentron Sensitrip IV circuit breaker is a true RMS current sensing device. Digital microprocessor circuitry within the electronic trip unit provides more precise control over the circuit breaker functions. This control allows circuit coordination flexibility not available with thermal magnetic circuit breakers.

Functions available in Sentron Sensitrip circuit breakers

Catalogue Number Suffix	Trip Type	Cont Current Setting	Long Time Delay	Instantaneous Pickup	Short Time Pickup	Short Time Fixed Delay	Short Time I ² t Delay	Ground Fault Pickup	Ground Fault Delay
LI	LI	✓	✓	✓					
LIG	LIG	✓	✓	✓				✓	✓
LSI	LSI	✓	✓	✓	✓	✓	✓		
LSIG	LSIG	✓	✓	✓	✓	✓	✓	✓	✓

Typical Trip Unit Labeling and Adjustment Positions for the Sentron Sensitrip Circuit Breaker.

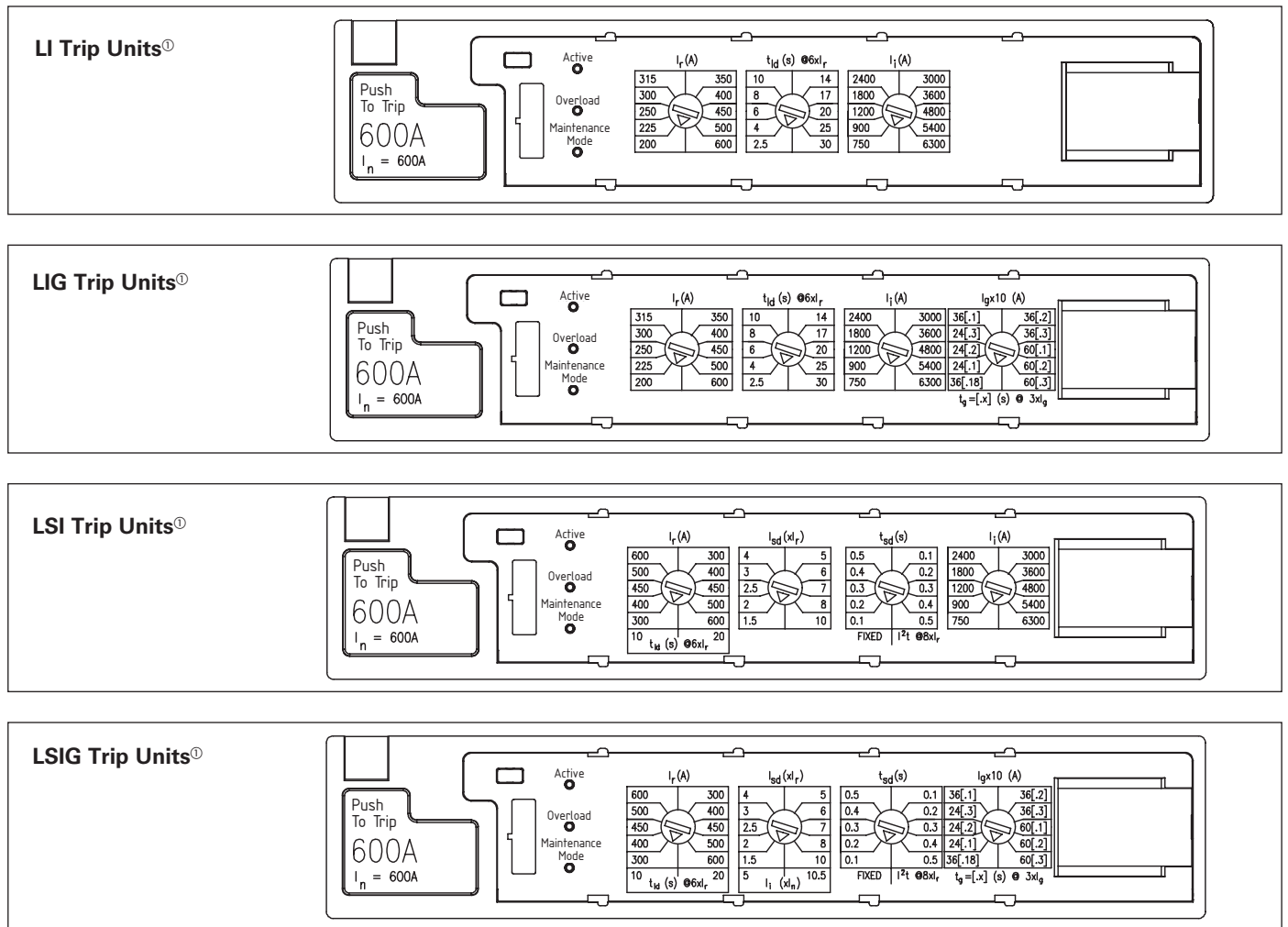

- I_n = Maximum circuit breaker ampere rating
- I_r = Continuous current rating expressed in amperes
- I_1 = Instantaneous pickup expressed in amperes
- I_{sd} = Short time pickup expressed in multiples of I_r

- I_g = Ground fault pickup expressed in amperes
- t_{sd} = Short time delay - either fixed or I^2t time delay function
- t_{ld} = Long time delay - I^2t time delay function
- t_g = Ground fault delay - I^2t time delay function

NOTE: Frame rating (I_n) of 600A shown as an example. Trip unit settings will vary based on the specific frame rating (I_n) of the device.

© Schematic of advanced trip unit shown. Basic trip units are identical but do not include DAS / Maintenance Mode functionality.

Molded Case Circuit Breakers

Digital Solid State Sentron Sensitrip IV Series

Technical

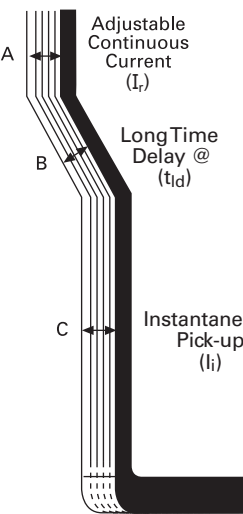

A. Adjustable "Continuous Amps" Rating Switch
All Sensitrip IV solid state molded case circuit breakers have an adjustable ampere rating switch. Adjustments made to this switch change the continuous current rating of the breaker.

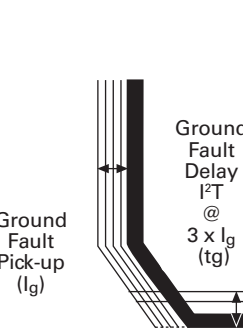

B. Adjustable "Long Time Delay" Switch
All Sensitrip IV circuit breakers have an adjustable long time delay switch to allow for selection of long time delays of fixed time intervals at six times the setting of the adjustable "continuous amps" rating switch.

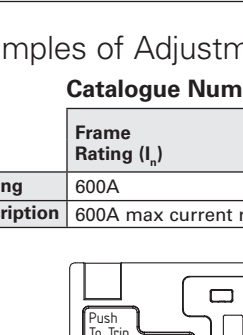

C. Adjustable "Instantaneous Pick-Up" Switch
Sensitrip IV circuit breakers with an adjustable instantaneous pick up switch allow selection of a specific instantaneous trip setting.

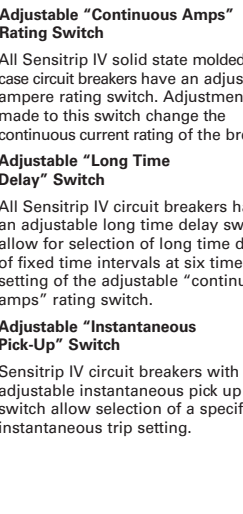

D. Adjustable "Short Time Pick-Up" Switch (Optional)
Sensitrip IV circuit breakers with an adjustable short time pick-up switch allow for selection of short time pick-up in a range from 1.5 to 10 times the setting of the maximum current rating.

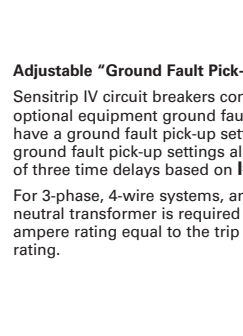

E. Adjustable "Short Time Delay" Switch (Optional)
Sensitrip IV circuit breakers with an adjustable short time delay switch also contain a switch for adjustment in time delay. The adjustable short time delay switch allows for either of two modes of short time delays. One range of settings enables the breaker to be set for fixed time delays and the other range of settings enables the breaker to be set for short time delays based on I²t curves.

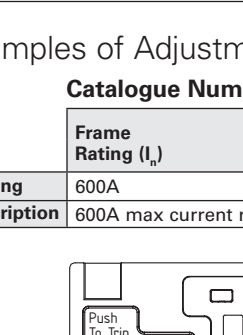

Adjustable "Ground Fault Pick-Up" Switch
Sensitrip IV circuit breakers containing the optional equipment ground fault protection have a ground fault pick-up setting. The ground fault pick-up settings allow for one of three time delays based on I²t curves.
For 3-phase, 4-wire systems, an external neutral transformer is required with an ampere rating equal to the trip unit ampere rating.

Adjustable "Ground Fault Pick-Up" Switch
Sensitrip IV circuit breakers containing the optional equipment ground fault protection have a ground fault pick-up setting. The ground fault pick-up settings allow for one of three time delays based on I²t curves.
For 3-phase, 4-wire systems, an external neutral transformer is required with an ampere rating equal to the trip unit ampere rating.

I_n = Maximum circuit breaker ampere rating
 I_r = Continuous current rating expressed in amperes
 I_i = Instantaneous pickup expressed in amperes
 I_{sd} = Short time pickup expressed in multiples of I_r
 I_g = Ground fault pickup expressed in amperes
 t_{sd} = Short time delay - either fixed or I²t time delay function
 t_{ld} = Long time delay - I²t time delay function
 t_g = Ground fault delay - I²t time delay function

Examples of Adjustment Settings

Catalogue Number SLD6A600LI

Setting	Frame Rating (I_n)	Switch 1	Switch 2	Switch 3
		Continuous Current Setting (I_r)	Long Time Delay Setting (t_{ld})	Instantaneous Pickup Setting (I_i)
Setting	600A	200	2.5	750
Description	600A max current rating	200A	2.5 sec to trip @ $6 \times I_r$ [$6 \times 200A = 1200A$]	750A

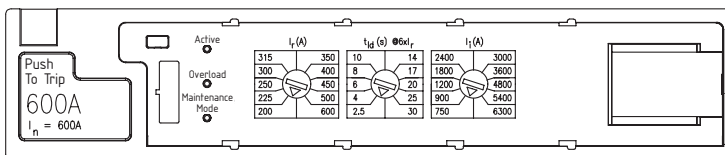

Catalogue Number SLD6A600LSIG

Setting	Frame Rating (I_n)	Switch 1		Switch 2		Switch 3	Switch 4
		Cont. Current Setting (I_r)	Long Time Delay Setting (t_{ld})	Short Time Pickup Setting (I_{sd})	Instantaneous Pickup Setting (I_i)	Short Time Delay Setting (t_{sd})	Ground Fault Pickup Setting (I_g)
Setting	600A	300	10	1.5	5	0.1	36 [.18]
Description	600A max current rating	300A	10 sec @ $6 \times I_r$ [$6 \times 300A = 1800A$]	$1.5 \times I_r$ [$1.5 \times 200A = 300A$]	$5 \times I_n$ [$5 \times 600A = 3,000A$]	0.1 sec	$I_g = 36 \times 10$ [$36 \times 10 = 360A$] $0.18 \text{ sec @ } 3 \times I_g$ [$3 \times 360 = 1,080A$]

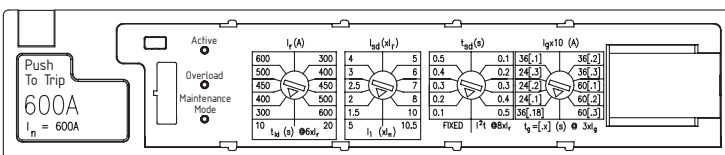

Enclosed Circuit Breakers

Enclosures

General



Type 1 — A general indoor, sheet-steel enclosure for use in normal atmospheres.

Type 3R — An outdoor, sheet-steel enclosure providing protection against driving rain, sleet or snow. Listed as service entrance equipment.

Types 12 — A special-industry, sheet-steel enclosure for use in atmospheres containing particles of lint, dust, dirt, sawdust and other foreign matter.

5

MOLDED CASE
CIRCUIT BREAKERS

Enclosed Circuit Breakers

Enclosed Breaker Nomenclature

General

Sample Part Numbers:	E	3R	ED	6	2	B	060	—	NC
	I	II	III	IV	V	VI*	VII	VIII*	IX*
	E	12	JXD	6	3	B*	200	—	NC
	I	II	III	IV	V	VI*	VII	VIII*	IX*
	E	1S	SHJD	6	B	—	400	LSIG	NC
	I	II	III	IV	V	VI*	VII	VIII*	IX*
I	Base model Start with E								
Placeholder Position Options									
II	May be replaced by 1S, 1F, 12, or 3R								
III	May be replaced by BQ, BQH, HBQ								
	May be replaced by QR, QRH, or HQR								
	May be replaced by ED, HED, HHED, CED								
	May be replaced by FD, FXD HFXD, HFD, HHFD, HHFXD, CFD								
	May be replaced by JD, JXD, HJD, HJXD, HHJD, HHJXD. CJD								
	May be replaced by FD, FXD JD, JXD, SJD, SHJD, SCJD								
	May be replaced by LD, LXD, HLD, HLXD. HHL, HHLCD, CLD, SLD, SHLD, SCLD								
	May be replaced by MD, MXD, HMD, HMXD, CMD, SMD, SHMD, SCMD								
	May be replaced by ND, NXD, HND, HNXD, CND, SND, SHND, SCND								
IV	May be replaced by 2, 4, 6								
V	May be replaced by 2, 3, B								
VI*	May be replaced by B, * If option not present omitted								
VII	May be replaced by :								
	QR	100, 125, 150, 175, 200, 225							
	ED	015, 020, 025, 030, 040, 045, 050, 060, 070, 080, 090, 100, 110, 125							
	FD	070, 080, 090, 100, 110, 125, 150, 175, 200, 225, 250							
	JD	200, 225, 250, 300, 350, 400							
	LD	300, 400, 450, 500, 600							
	MD	600, 700, 800							
	ND	900, 1000, 1200							
VIII*	May be replaced by "LI, LIG, LSI, LSIG, if option+ not present position omitted								
IX*	NC: Suitable for service entrance,+ If option not present position omitted								

The enclosed breakers are factory assembled. Each enclosed breakers assembly includes the selected type of enclosures, circuit breakers, standard lugs, and Neutral.

Enclosed Circuit Breakers

Enclosures — Type 1

Selection/Dimensions

Dimensions

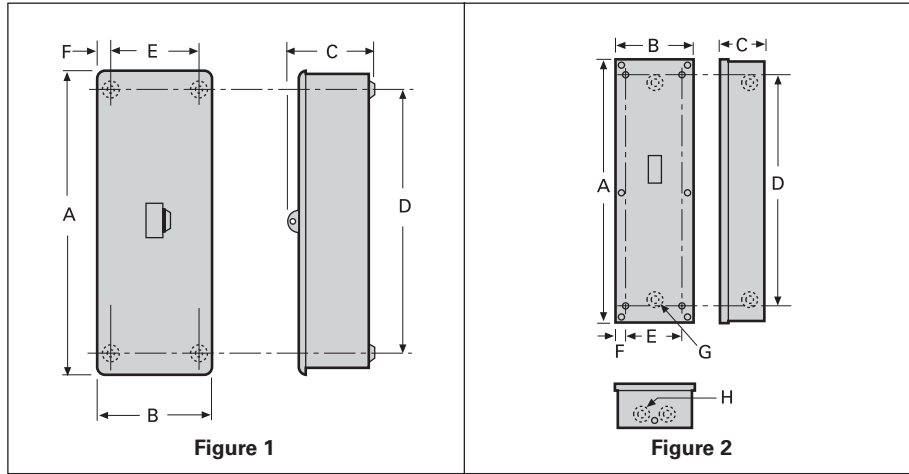

Type 1

Fig. No.	Breaker Type	Number of Poles	Maximum Current Rating	Catalogue [®] Number	Weight Lb./Ship. Package	Dimensions (inches)						K.O. Dimensions	
						A	B	C	D	E	F	6 Plcs.	2 Plcs.
1	BQ, BQH, HBQ	3		EB3100S ^{①②⑦}	32	17 ^{1/8}	7 ^{1/8}	4 ^{3/4}	14 ^{1/6}	1 ^{5/16}	1 ^{5/16}	—	—
2	ED2, ED4, ED6, HED4, HED6	3	100	E2N1S ^② E2N1F ^②	8 8	16 ^{23/32} 17 ^{1/2}	7 ^{1/2} 8 ^{1/2}	5 ^{1/16}	13 ^{45/64}	5 ^{1/4}	1	7/8, 11/8, 13/8, 13/4, 2, 21/2, 3	
	ED4, ED6, HED4, HED6, CED6		125	CED6N1S ^{②⑥} CED6N1F ^{②⑥}	14 14	21 ^{15/32} 22 ^{1/4}	7 ^{19/32} 8 ^{1/2}	5 ^{7/64}	18 ^{1/4}				
	FXD6, FD6, FXD6-A, FD6-A, HFD6, HFXD6, HHFD6, CFD6		250	F6N1S ^③ F6N1F ^③	33	38 ^{13/32}	11 ^{15/32}	5 ^{1/16}	33	8	13 ^{3/64}		
3	JXD2(A), JD6(A), JXD6(A), HJD6(A), HJXD6(A), HHJD6, HHJXD6, SJD6(A), SHJD6(A), SXD6H	2-3	400	J6N1 ^③	120	40 ^{13/64}	22 ^{27/64}	10 ^{45/64}	36	18 ^{1/4}	2 ^{5/64}	—	—
	LD6(A), LXD6(A), HLD6(A), HLXD6(A), HHL6, HHLXD6, SLD6(A), SHLD6(A), SCJD6, SCLD6, LXD6H		600	LD6N1 ^③ (L6N1) ^③	101	46			42			—	—
	MD6, MXD6, SMD6, HMD6, HMXD6, SHMD6, ND6, NXD6, SND6, HND6, HNXD6, SHND6, CMD6, SCMD6, CND6, SCND6		1200	MND61 ^③	132	60	10	55 ^{7/8}	—			—	

5 MOLDED CASE CIRCUIT BREAKERS

For inches / millimeters conversion, see Technical section.

- ① Surface mounted, indoor. If flush mounting is required, replace suffix "S" in catalogue number with suffix "F". Also, if outdoor model required, use prefix "W" instead of "E".
- ② Does not include circuit breaker. Order circuit breaker separately.
- ③ Neutral not included. Order as separate item from table on next page.
- ④ Neutral included in enclosure.

- ⑤ Surface mounted, indoor. If outdoor model is required, use prefix "W" instead of "E". Not available in flush ("F") model.
- ⑥ Use for 110-125 ampere ED4, ED6, HED4 or HED6 circuit breakers.
- ⑦ Will not accept breaker with shunt trip.
- ⑧ Will not accept 2-pole GFCI or breaker with shunt trip.
- ⑨ Items cannot be ordered separately. See configuration.

Built to order. Consult sales office for factory lead time and prices.

Enclosed Circuit Breakers

Enclosures — Type 1

Selection/Dimensions

Dimensions

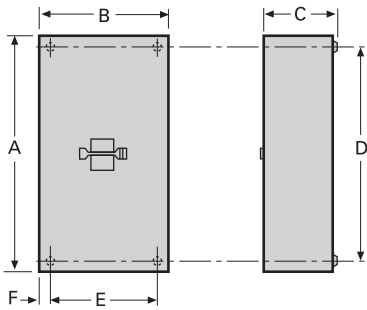

Figure 3

Fig. No.	Breaker Type	Number of Poles	Maximum Current Rating	Catalogue® Number	Weight Lb./Ship. Package	Dimensions (inches)							
						A	B	C	D	E	F	G	H
1	BQ, BQH, HBQ	3	100	EB3100S ^{①②}	32	17 ^{1/8}	7 ^{1/8}	4 ^{3/4}	14 ^{1/8}	1 ^{5/16}	1 ^{5/16}	—	—

Neutrals

Enclosure Catalogue Number	Neutral Catalogue Number	Neutral Cable Capacity and Wire Range
E2N1(S)(F) CED6N1(S)(F)	W53045 ^③	(1 pc.) #14–2 Cu/Al Grd. Lug (1 pc.) #14–8 Cu/Al
F6N1(S)(F)	N250 (NFD)	(1 pc.) #6–350 kcmil Grd. Lug (1 pc.) #14–2/0 Cu/Al
J6N1	W60992 (NJD)	(1 pc.) #1/0–750 kcmil Cu/Al or (2 pcs.) #1/0–300 kcmil Cu/Al Grd. Lug (1 pc.) #6–250 kcmil Cu/Al
LD6N1	W60993 (NLD)	(2 pcs.) #1/0–600 kcmil Grd. Lug (1 pc.) #6–250 kcmil Cu/Al
MND61	W63623 (NMND)	(8 pcs.) 250 kcmil–500 kcmil Cu/Al Grd. Lug (1 pc.) #6–300 kcmil Cu/Al

For inches / millimeters conversion, see Technical section.

① Does not include circuit breaker. Order circuit breaker separately.

② Neutral included in enclosure.

③ Items cannot be ordered separately. See configuration.

Built to order. Consult sales office for factory lead time and prices.

Enclosed Circuit Breakers

Enclosures — Type 3R

Selection/Dimensions

Dimensions

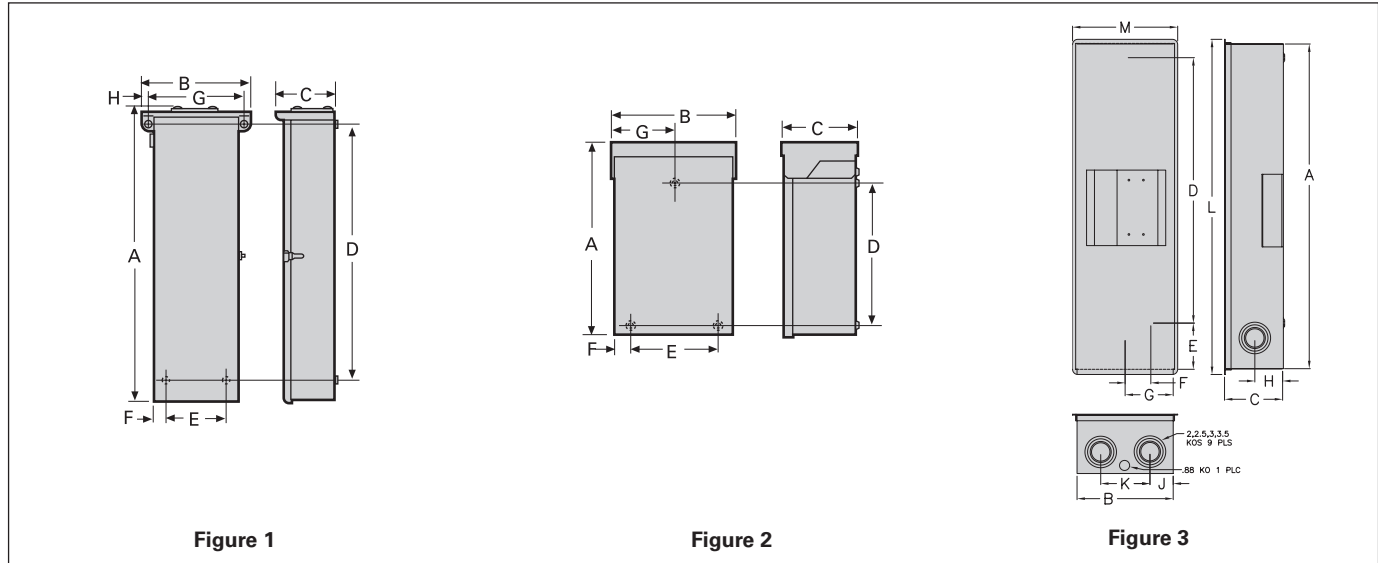

Figure 1

Figure 2

Figure 3

Type 3R

Fig. No.	Breaker Type	Number of Poles	Maximum Current Rating	Catalogue Number	Weight Lb./Ship. Package	Dimensions (inches)							
						A	B	C	D	E	F	G	H
2	BQ, BQH, HBQ	3	50 100	WB3100 ^④	9	17 ^{1/8}	7 ^{3/8}	4 ^{5/16}	14 ^{1/8}	4 ^{1/2}	1 ^{1/8}	3 ^{11/16}	—
5	ED2, ED4, ED6, HED4, HED6 CED6	2-3	100 125	E2N3R ^③ CED6N3R ^③	12 16	17 ^{9/16} 22 ^{21/64}	7 ^{1/4}	5 ^{1/4}	12 ^{39/64} 17 ^{3/8}	5 ^{1/4}	1	3	—
1	FXD6, FD6, FXD6-A, FD6-A, HFD6, HFXD6, HHFD6, CFD6		250	F6N3R ^②	45	38 ^{1/8}	14 ^{1/16}	7 ^{3/4}	33 ^{9/32}	8	13/16	13 ^{1/2}	13/16
	JXD2(A), JD6(A), JXD6(A), HJD6(A), HJXD6(A), HHJD6, HHJXD6, SJD6(A), SHJD6(A), SXD6H		400	J6N3R ^②	126	40 ^{63/64}	26 ^{3/4}	11 ^{23/32}	40 ^{3/4}	18 ^{1/4}	2 ^{1/8}	24 ^{1/2}	1 ^{1/8}
	LD6(A), LXD6(A), LXD6H, HLD6(A), HLXD6(A), HHL6(A), CLD6, SCJD6(A), SLD6(A), SHLD6(A)		600	LD6N3R ^②	127	45 ^{63/64}							
	MD6, MXD6, SMD6, HMD6, HMXD6, SHMD6, ND6, NXD6, SND6, HND6, HNXD6, SHND6, CMD6, SCMD6, CND6, SCND6		1200	MND63 ^②	210	61 ^{9/64}							

For inches / millimeters conversion, see Technical section.

- ① Does not include circuit breaker. Order circuit breaker separately.
- ② Neutral not included. Order as separate item from table on next page.

- ③ Neutral included in enclosure.
- ④ Will not accept breaker with shunt trip.
- ⑤ Items cannot be ordered separately. See configuration.

Enclosed Circuit Breakers

Enclosures — Type 3R

Selection/Dimensions

Dimensions

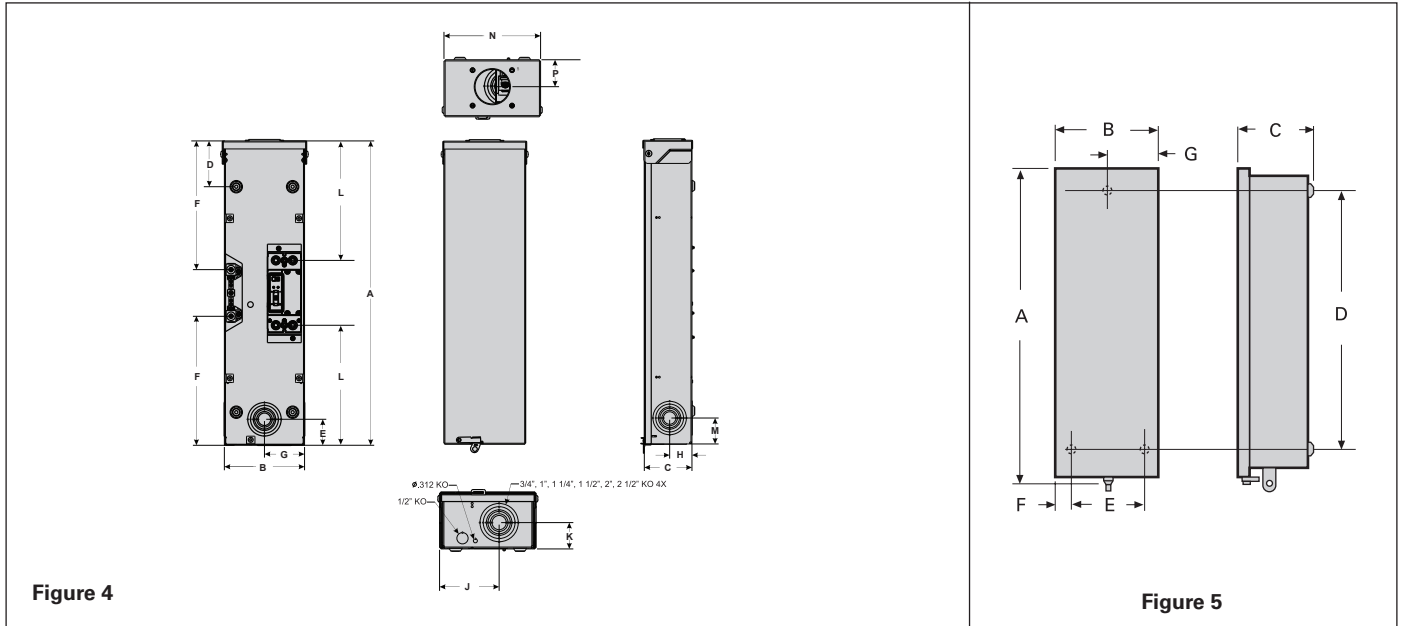

Figure 4

Figure 5

Fig. No.	Breaker Type	Number of Poles	Maximum Current Rating	Weight Lb./Ship. Package	Dimensions (inches)													
					A	B	C	D	E	F	G	H	J	K	L	M	N	P
3	QR2, QR2H, HQR2, QR2H	3	225A	40	31.4	9.1	5.6	25.3	6.1	2.4	4.6	2.2	2.1	4.9	32.2	9.6	—	—
4	QR2, QR2H, HQR2, QR2H	2	225A	40	27	7.1	4.2	4.1	2.3	11 ^{1/2}	3.6	2	4.6	2	10.7	2.3	7 ^{1/2}	2.1

Neutrals

Enclosure Catalogue Number	Neutral Catalogue Number	Neutral Cable Capacity and Wire Range
E2N3R ^③	W53045 ^③	(1 pc.) #14–2 Cu/Al Grd. Lug (1 pc.) #14–8 Cu/Al
CED6N3R ^④		
F6N3R ^②	N250	(1 pc.) #6–350 kcmil Grd. Lug (1 pc.) #14–2/0 Cu/Al
JD6N3R ^②	W60992	(1 pc.) #1/0–750 kcmil Cu/Al or (2 pcs.) #1/0–300 kcmil Cu/Al Grd. Lug (1 pc.) #6–250 kcmil Cu/Al
LD6N3R ^②	W60993	(2 pcs.) #1/0–600 kcmil Grd. Lug (1 pc.) #6–250 kcmil Cu/Al
MND63 ^②	W63623	(8 pcs.) 250 kcmil–500 kcmil Cu/Al Grd. Lug (1 pc.) #6–300 kcmil Cu/Al

Hubs — see page 5-146

For inches / millimeters conversion, see Technical section.

- ① Does not include circuit breaker. Order circuit breaker separately.
- ② Neutral not included. Order as separate item from table on next page.

- ③ Neutral included in enclosure.
- ④ Use CED enclosure for all ED-frame 110-125 ampere units.
- ⑤ Items cannot be ordered separately. See configuration.

Enclosed Circuit Breakers

Enclosures — Type 12

Selection/Dimensions

Fig. No.	Breaker Type	Number of Poles	Maximum Current Rating	Catalogue [®] Number	Weight Lb./Ship. Package	Dimensions (inches)					
						A	B	C	D	E	F
2	ED2, ED4, ED6, HED4, HED6	2-3	100	E2N12[®]	12	18 ^{5/8}	8 ^{11/32}	7 ^{1/16}	18	6 ^{1/16}	1/2
5	CED6		125	CED6N12[®]	16	22 ^{5/8}			22		5/8
1	FXD6, FD6, FXD6-A, FD6-A, HFD6, CFD6		250	F6N12[®]	40	38 ^{19/32}	14 ^{29/64}	8 ^{1/8}	34	13	22/32
	JXD2(A), JD6(A), JXD6(A), HJD6(A), HJXD6(A), HHJD6, HHJXD6, SJD6(A), SHJD6(A)		400	J6N12[®]	104	40	25 ^{35/64}	11 ^{7/8}	36	25 ^{35/64}	—
	LD6(A), LXD6(A), HLD6(A), HLXD6(A), HHL6, HHLXD6, SLD6(A), SHLD6(A), CJD6, CLD6, SCJD6(A), SCLD6(A)		600	LD6N12[®] (L6N12)					45		41
MD6, MXD6, SMD6, HMD6, HMXD6, SHMD6, ND6, NXD6, SND6, HND6, HNXD6, SHND6, CMD6, SCMD6, CND6, SCND6	1200	MND612[®]	220	60	37 ^{3/8}	10	5/8	3	2		

Dimensions

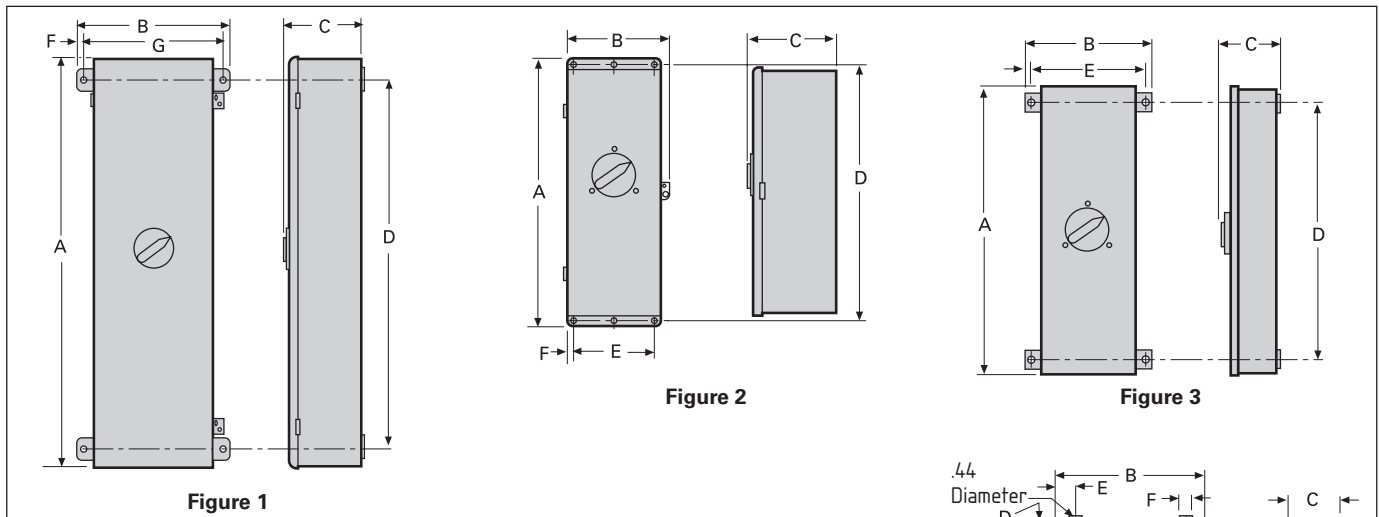

Neutrals

Enclosure Catalogue Number	Neutral Catalogue Number	Neutral Cable Capacity and Wire Range
E2N12[®]	W53045[®]	(1 pc.) #14-2 Cu/Al
CED6N12[®]		(1 pc.) #14-2 Cu/Al
F6N12[®]	N250[®]	(1 pc.) #6-350 kcmil Grd. Lug (1 pc.) #14-2/0 Cu/Al
J6N12[®]	W60992[®]	(1 pc.) #1/0-750 kcmil Cu/Al or (2 pc.) #1/0-300 kcmil Cu/Al Grd. Lug (1 pc.) #6-250 kcmil Cu/Al
L6N12[®]	W60993[®]	(2 pcs.) #1/0-600 kcmil Grd. Lug (1 pc.) #6-250 kcmil Cu/Al
MND612[®]	W63623[®]	(8 pcs.) 250 kcmil-500 kcmil Cu/Al Grd. Lug (1 pc.) #6-300 kcmil Cu/Al

For inches / millimeters conversion, see Technical section.

- ① Does not include circuit breaker. Order circuit breaker separately.
- ② Neutral not included. Order as separate item.

- ③ Neutral included in enclosure.
- ④ Use CED enclosure for all ED-frame 88-90 ampere units.
- ⑤ Items cannot be ordered separately. See configuration.

Enclosed Circuit Breakers

Selection/Dimensions

Knockouts & Wire Bending Space

Breaker Type	Conduit Range Per Knockout Outside Dimensions (inches)	Types 1, 12				Type 3R			Maximum Cable Sizes Recommended (Cu/Al) for Type 1, 3R, 4, 4X, 12 & 12K Enclosures ^{②③}		
		Number of Knockouts Per Panel (type 12 have no KO's)									
		Top	Bottom	Side	Back	Bottom	Side	Back		Maximum Hub Size (inches) Type 3R	
BQ, BQH, HBQ 70–100A	3/4, 1, 1 ^{1/4}	1	1	2	2	8	1	3	2	②	
ED2, ED4, ED6, HED4	7/8, 1 ^{1/8} , 1 ^{3/8} , 1 ^{3/4} , 2	2	2	2	2	2	1	1	2	②	
CED6	7/8, 1 ^{1/8} , 1 ^{3/8} , 1 ^{3/4} , 2 7/8, 1 ^{1/8} , 1 ^{3/8} , 1 ^{3/4} , 2, 2 ^{1/2}	— 2	— 2	— 2	— 2	2 —	— 1	— 1	2	(CFD6 only 300 kcmil) ^③	
FXD6, FD6, FXD6-A, FD6-A, HFD6, CFD6	1 ^{1/8} , 1 ^{3/8} , 1 ^{3/4} , 2, 2 ^{1/2} , 3	1 1	1 1	2 —	2 —	1 1	1 —	— —	4	②	
JXD2(A), JXD6(A), JD6(A), HJD6(A), HJXD6(A), HHJD6, HHJXD6, SJD6(A), SHJD6(A)	1 ^{1/2} , 2, 2 ^{1/2} , 3, 3 ^{1/2} , 4	1	1	2	4	—	—	—	4	(2) 500 kcmil	
LXD6(A), LD6(A), HLXD6(A), HLD6(A), HHLXD6, HHLXD6, SLD6(A), SHLD6(A)	1 ^{1/2} , 2, 2 ^{1/2} , 3, 3 ^{1/2} , 4	1	1	2	4	—	—	—	4	(2) 500 kcmil	
MD6, SMD6, HMD6, ND6, SND6, HND6	—	—	—	—	—	—	—	—	4	(3) 600 kcmil or (4) 500 kcmil	

Hubs (Type 3R)

Breaker Type	Conduit Size (inches)	Catalogue Number
BQ, BQH, HBQ, ED2, ED4, ED6, HED4, HED6, CED6	3/4 1 1/4 1 1/2 2	ECHR075 ECHR100 ECHR125 ECHR150 ECHR200
FXD6-A, FD6-A, HFD6, HFXD6, CFD6, JXD2(A), JD6(A), JXD6(A), HJD6(A), HJXD6(A), LD6(A), LXD6(A), HLD6(A), HLXD6(A)	2 1/2 3 3 1/2 4	ECHV250 ECHV300 ECHV350 ECHV400



Note: Enclosures for 250A max breakers have a hub provision on the rainshed. Enclosures for larger breakers (J, L, M & N frame) have blank top rainsheds. Drill or punch hole in the field to accommodate hub size desired.

For inches / millimeters conversion, see Technical section.

- ① 17^{1/8}" high enclosure provides sufficient wire bending space for all available CB lugs.
- ② Sufficient wire bending space is provided for all available mechanical type CB lugs.

- ③ The use of cables larger than those listed below may violate NEC & CSA wire bending space requirements.
- ④ The use of compression type connectors will violate NEC and CSA wire bending space requirements.

Lug Information

Mechanical Lug

Selection

For Use With Type(s)	Circuit Breaker Ampere Rating	Cables Per Lug	Lug Wire Range	Catalog Number
BQ, BQH, BQHF, BQE, BQF, BL, BLH, HBL, HBQ Switching Neutrals BG, BLG	Line Side			
	15-40	1 1	#14-#6 AWG Cu #12-#6 AWG Al ¹	TC1Q1 ^②
	45-125	1 1	#8-#1 AWG Cu #6-#1/0 AWG Al	TA1Q1 ^②
	Load Side			
	15-20	1 1	#14-#10 AWG Cu #12-#10 AWG Al	Lugs are integral to Circuit Breaker
	25-35	1 1	#14-#6 AWG Cu #12-#6 AWG Al	
	40-50	1 1	#8-#6 AWG Cu #8-#4 AWG Al	
	55-70 *exceptions in Table A	1 1	#8-#4 AWG Cu #8-#2 AWG Al	
	80-100	1 1	#4-#1/0 AWG Cu #2-#1/0 AWG Al	
	110-125	1 1	#2-#1/0 AWG Cu #1/0-#2/0 AWG Al	
BQD, CQD BQD6	Line Side (CQD) & Load Side			
	15-40	1	#14-#6 AWG Cu #12-#6 AWG Al	Integral
	45-100	1	#8-#1 AWG Cu #6-#1/0 AWG Al	Integral
NGG, HGG, LGG	15-30	1	#14-#6 AWG Cu #12-#6 AWG Al	TC1Q1
	15-30	1	#14-#6 AWG Cu #12-#6 AWG Al	3TC1Q1 (pkg. of 3)
	35-125	1	#8-#1/0 AWG Cu #8-#2/0 AWG Al	3TC1GG20 (pkg. of 3)
	15-125	—	NUT KEEPER PLATE	TNKG3c (pkg. of 3)

Connector wire ranges and cavities are established in conjunction with Table 6.1.4.2.1 of UL 489 standards.

Table A

For Use With Type(s)	Circuit Breaker Ampere Rating	Cables Per Lug	Lug Wire Range	Number of Poles
BQ, BL, QP	Load Side			
	55-60	1	#8-#4 AWG Cu-Al #3 AWG requires 22 or 65 kAIC	This exception is applicable to 1- and 2-pole only

Note:

- (A) Molded case circuit breakers having a rated ampacity of 125 amperes or less are to be connected with 60 or 75°C wire. Circuit breakers having a rated ampacity greater than 125 amperes shall only be cabled with 75°C cable unless otherwise indicated on the circuit breaker label. Exceptions to this rule are outlined in article 110-14 C(1)(2) of the 2005 National Electric Code and table 6.1.4.2.1 per CSA C22.2 No5.02 standard.
- (B) Connector wire ranges and cavities are established in conjunction with Table 6.1.4.2.1 of UL 489 standards.

- ① Lug is steel.
 ② Sold in package of six.
 ③ One nut keeper plate is required with each lug on the NGG breaker.

Lug Information

Aluminum Body Lugs for Copper or Aluminum Wire

Selection

For Use With Type(s)	Circuit Breaker Ampere Rating	Cables Per Lug	Lug Wire Range	Catalogue Number
QJ2, QJH2 QJ2H, HQJ2H	60–225	1	#6 AWG–300 kcmil (Cu) #4 AWG–300 kcmil (Al)	TA1Q300 (pkg of 3)
All 2, 3 pole ED2, ED4, ED6, ED6 ETI, HED4,	15–25	1	"#14–#10 AWG (Cu) #12–#10 AWG (Al)"	SA1E025
	30–100	1	#10–#1/0 (Cu or Al)	LN1E100
	110–125	1	#3-3/0 (Cu) #1-2/0 (Al)	TA1E6125
CED6 All 1 pole ED, HED	30–60	1	#10–4 (Cu or Al)	LD1E060 (Load Side)
	70–100	1	#4–#1/0 (Cu or Al)	LD1E100 (Load Side)
FXD6-A, FD6-A, HFD6, CFD6 HHFD6	70–250	1	#6 AWG–350 kcmil (Cu) #4 AWG–350 kcmil (Al)	TA1FD350A
SJD6(A), SHJD6(A) SCJD6	65–200	1–2	#4 AWG–310 kcmil (Cu or Al)	TA2J630
JXD2(A), JXD6(A), JD6(A), SJD6(A), HJD6(A), HHJXD6, HHJD6, SHJD6(A), CJD6, SCJD6	200–400	1–2	3/0–500 kcmil (Cu) 4/0–500 kcmil (Al)	TA2J6500
LXD6(A), LD6(A), SLD6(A), HLD6(A), HHLXD6, HHL6, SHLD6(A), CLD6, SCLD6	250–600	1–2	3/0–500 kcmil (Cu) 4/0–500 kcmil (Al)	TA2J6500
LMD6 ^① , LMXD6 ^① , HLM6 ^① , HLMXD6 ^① , MD6, MXD6, SMD6, HMD6, HMXD6, SHMD6, CMD6, SCMD6	500–600	1–2	#1–500 kcmil (Cu or Al)	TA2K500
		1–3	1/0–500 kcmil (Cu or Al)	TA3K500
ND6, NXD6, SND6, HND6, HNXD6, SHND6, CND6, SCND6	800–1200	1–4	250–500 kcmil (Cu or Al)	2TA4P8500 ^{②③} 3TA4P8500 ^④
			250–500 kcmil (Cu or Al)	2TA4N8500 ^③ 3TA4N8500 ^④
PD6, HPD6, CPD6 PXD6, HPXD6, SPD6, SHPD6	1200–1600	1–5	300–600 kcmil (Cu or Al)	TA5P600
PD6, PXD6, HPD6, HPXD6, SPD6, SHPD6, RD6, RXD6, HRD6, HRXD6	1200–2000	1–6	300–600 kcmil (Cu or Al)	TA6R600

① Use TA2K500 or TA3K500 only.
② Contains 2 connectors plus 1 NDTs end barrier.
③ Contains 3 connectors plus 1 NDTs end barrier.

Lug information

Optional Mechanical Lugs

Selection

For Use With Type	Circuit Breaker Ampere Rating	Cables Per Lug	Lug Material	Lug Wire Range	Qty per Cat. #	Catalogue Number
QJ2, QJH2, QJ2H, HOJ2H	60–225	1	Cu	#6 AWG–250 kcmil (Cu)	1	TC1Q250
ED, HED 2&3 pole	2–3 pole 30-125	1	Cu	#10–#1/0 (Cu)	1	TC1ED6150
HFD6, HHFD6, CFD6, F(X)D6-A	70–250	1	Cu	#6 AWG–350 kcmil (Cu)	1	TC1FD350
J(X)D2(A), J(X)D6(A), HJD6(A), HHJD6, SHJD6(A), L(X)D6(A), HHL6, SCD6, HLD6(A), SHLD6(A), CJD6, CLD6, SCJD6, SCLD6	200–600	1 1–2	Cu	3/0–600 kcmil (Cu) 3/0–500 kcmil (Cu)	1 1	TC1J6600 [Ⓞ] TC2J6500 [Ⓞ]
	250–600	1 1	Al	500–750 kcmil (Al) 500–600 kcmil (Cu)	1	TA1L6750
SMD6, M(X)D6, HM(X)D6, HMD6, CMD6, SCMD6, SND6, N(X)D6, HN(X)D6, SHND6, CND6, SCND6	500–600	1–2	Cu	#1 AWG–500 kcmil (Cu)	1	TC2K500
	700–800	1–3	Cu	#1 AWG–350 kcmil (Cu)	1	TC3K350
		1–2	Al	500–750 kcmil (Cu) 500–750 kcmil (Al)	2 3	2TA2N8750 3TA2N8750
	800–1200	1–3	Al	500–750 kcmil (Cu) 500–750 kcmil (Al)	2 3	2TA3N8750 3TA3N8750
R(X)D6, HR(X)D6	1600–2000	1–5	Cu	300–600 kcmil (Cu)	1	TC5R600
P(X)D6, HP(X)D6, CPD6, SPD6, SHPD6	1200–1600	1–4	Al	600–750 kcmil (Cu/Al)	1	TA4P750

Compression Lugs

For Circuit Breaker Types	Ampere Rating	Poles	Lugs Per Kit	Lug Wire Size	Catalogue Number
Lugs (contains indicated number of lugs and necessary hardware per kit)					
ED2, ED4, ED6, HED4, CED4	15–125	1, 2, 3	1	#2/0 AWG Cu/AL	CCE125
QJ2, QJH2, QJ2-H	125–225	2, 3	1	350 kcmil Cu/AL	CCQ225
F(X)D6-A, HF(X)D6, HHF(X)D6, CFD6	125–250	2, 3	1	350 kcmil	CCF250
JXD2-A, J(X)D6-A, HJ(X)D6-A, HHJ(X)D6-A, CJD6, SJD6-A, SHJD6-A, SCJD6, L(X)D6-A, HL(X)D6-A, CLD6, SLD6-A, SHLD6-A, SCLD6	200–600	2, 3	1	500 kcmil	CCL600
Kits (contain lugs and hardware for complete line or load end of 2 or 3 pole breaker)					
M(X)D6, HM(X)D6, CMD6, SMD6, SHMD6, SCMD6	500–800	2	6	500 kcmil	CCM800K2
		3	9		CCM800K3
N(X)D6, HN(X)D6, CND6, SND6, SHND6, SCND6	900–1200	2	8		CCN1200K2
		3	12		CCN1200K3

Distribution Lugs[Ⓞ]

For Circuit Breaker Types	Ampere Rating	Poles	Lugs Per kit	Wires Per Lug	Lug Wire Size	Catalogue Number
NGG, HGG, LGG	15-125	1,2,3	1	6	#6-#4 AL #14-#4 Cu	TA6GG04
ED2, ED4, ED6, HED4, HHED6, CED6	15-125	1,2,3	1	6	#14-#4 AWG Cu #6-#4 AWG Al	TA6ED06
F(X)D6-A, HF(X)D6, HHF(X)D6, CFD6	70-250	2,3	1	6	#14-#4 AWG Cu #6-#4 AWG Al	TA6FD04
XD2-A, J(X)D6-A, HJ(X)D6-A, HHJ(X)D6-A, CJD6-A, JD6, L(X)D6-A, HL(X)D6-A, CLD6-A, LD6-A, SCLD6	200-600	2,3	1	6	14-2/0 AWG Cu #6-2/0 AWG Al	TA6JD20

[Ⓞ]Used for 100% rated JD/LD frame circuit breakers.

[Ⓞ] Special purpose wire connectors, not for general use.

Molded Case Circuit Breakers

Modifications

A variety of internal and external accessories, as well as modifications, are available to adapt Siemens circuit breakers to special installation requirements. CSA approved / UL listed internal accessories for 100 through 2000A circuit breakers are field-addable.

Internal accessories fine tune an electrical distribution system, allowing control of the circuit breakers to meet special application requirements. For example, emergency situations may dictate tripping critically placed circuit breakers quickly. Shunt trips accomplish this conveniently and efficiently. Or, when voltage drops are a concern, undervoltage trips automatically open the circuit breaker at a predetermined voltage level.

A wide range of external operating and mounting accessories is also available. For example, face, shallow, and back mounting plates are ideal for tailoring BQ circuit breakers to OEM applications. A complete line of operating handles and handle-blocking devices meet switchboard, enclosure and safety needs. Plug-in mounting assemblies, which simplify switchboard mounting of circuit breakers and permit breaker removal without disconnecting bus or cable connections, are available.

UL 489 Supplement SB Naval Use Breakers

Breakers tested to UL 489 Supplement SB are qualified for use on non combat and auxiliary naval vessels.

Siemens' molded case breakers from the ED frame through the 2000 Amp SB frame can be labeled "Naval" in compliance with Supplement SB.

Supplement SB testing comprises two sets of vibration tests. The first is to find mechanical resonances in the product and to subject the breaker to extreme testing at each resonant frequency. The second is a swept frequency test, in which the frequency of excitation is changed in intervals of 1Hz, and held at each frequency for five minutes. The excitation frequencies run from 4 to 33Hz, and the test is conducted in each of the three orthogonal axes of the breaker.

During these tests, the breaker must not trip from the closed position, nor may the contacts touch from the open position. Calibration and insulation resistance are also verified during the test.

For detailed information, refer to UL 489, Supplement SB.

Selection/ General

Modifications^①

50°C Ambient Calibration — Not CSA approved / UL listed and not available for solid state, 100% rated breakers or 400HZ calibrated breakers.

- For BL Type Circuit Breakers
 - Add suffix 'M' to catalogue number (Example: B120M)
- For BQ, QJ2, and ED Frame Circuit Breakers
 - Replace 'B' in catalogue number with 'M' (Example: BQ3M060, QJ23M200, ED63M060)
- For FD, JD, LD, LMD, MD, ND, PD, and RD Frame Circuit Breakers
 - Non-Interchangeable Trip (3-pole only)
 - Replace 'B' in catalogue number with 'M' (Example: FXD63M225, JXD63M400)
 - Interchangeable Trip (trip unit only, 3-pole only)
 - Replace 'T' in catalogue number with 'W' (Example: FD63W200, JD63W400)

400 HZ Calibration

- CSA approved / UL Listed (5KA IR)
 - For BQ, BL, and QJ Type Circuit Breakers (200A max.)
 - Add suffix 'Y' to catalogue number
- Not CSA approved / UL Listed
 - For all other Circuit Breakers — Add suffix 'Y' to catalogue number

Fungus Proofing — In accordance with MIL-T-152.

- All BQD, CQD, NGG, ED, FD, JD, LD, LMD, MD, ND, PD, and RD, Frame Circuit Breakers are inherently fungus resistant and do not require special treatment.
- Fungus proofing in accordance with MIL-T-152
 - For BL, and BQ Type Circuit Breakers
 - Order must be placed directly with the factory by the sales office.
 - For all other Circuit Breaker Types
 - Order must be placed directly with the factory by the sales office.

Certificate of Compliance

Certificate of compliance testing must be performed on the actual device being shipped. The certificate cannot be provided after initial shipment. Order for devices with COC requirement must be placed directly with the factory by the sales office.

Ordering Information^②

For "NAVAL" label, order must be placed directly with the factory by Siemens Sales Office.

Types	UL File
ED2, ED4, ED6, HED4	E10848, Vol 4, Sec 11
CED6	E10848, Vol 4, Sec 13
FD6, FXD6, HFD6, HFXD6	E10848, Vol 4, Sec 17
CFD6	E10848, Vol 4, Sec 18
JXD2, JD6, JXD6, LXD6, LD6, HJD6, HJXD6, HLD6, HLXD6	E10848, Vol 4, Sec 8
HHJD6, HHJXD6, HHL6, HHLXD6	E10848, Vol 4, Sec 20
CJD6, CLD6	E10848, Vol 4, Sec 14
MD6, MXD6, HMD6, HMXD6, CMD6, ND6, NXD6, HND6, HNXD6, CND6	E10848, Vol 4, Sec 15
PD6, PXD6, HPD6, HPXD6, CPD6, RD6, RXD6, HRD6, HRXD6	E10848, Vol 4, Sec 19

① Consult sales office for pricing.

Molded Case Circuit Breakers

Internal Accessories

Selection/ General

Feature Combinations

The available feature combinations are shown in the chart below. For applications requiring combinations of features not listed in this chart, consult the sales office for availability.

Breakers	Modules/ Breaker	Avail. On Breaker Poles	ST	ST/ AUX	ST/ ALSW	ST/ AUX/ ALSW	UVT	UVT/ AUX	UTV/ ALSW	UVT/ ST/ ALSW	AUX	AUX/ ALSW	ALSW	Elect. Bell Alarm	Ground Fault	Ground Fault w/Bell
QP, BQ, BL ^①	1	1, 2, 3	1	—	—	—	—	—	—	—	1, 2	—	—	—	—	—
BQD, CQD, NGG	1	2, 3	1	1/1	—	—	—	—	—	—	1, 2	1/1	1	—	—	—
QR ^②	1	2, 3	1, 2	1/1, 2/2	—	—	—	—	—	—	2	—	—	—	—	—
All ED, EF	1	1, 2, 3	1	1/1	1/1	1/1/1	1	1/1, 1/2	1/1	1/1/1	1, 2	1/1, 2/1	1	—	1	1
All FD, FF	2	2, 3	1	—	—	—	1	1	—	—	1, 2	1/1	1	—	—	—
All JD, LD, LMD ^③	2	2,3	1	1	—	—	1	1/1, 1/2	—	—	1, 2	—	1, 2	—	—	—
SJD6, SHJD6, SCJD6, SLD6, SHLD6, SCLD6 ^④	1	3	1	1	—	—	1	1/1, 1/2	—	—	1, 2	—	1, 2	—	—	—
All MD, ND, PD, RD Including Electronic trip ^⑤	2	2,3	1	1/1	—	—	1	1/1, 1/2	—	—	1, 2	1/1, 2/1	1, 2	—	—	—

Shunt Trip (ST)

One or all critical circuit breakers may be tripped from a distant control point by use of a shunt trip device. A shunt trip operates through an auxiliary switch contact; when the breaker opens, current is not maintained on the shunt trip coil.

Undervoltage Trip (UVT)

When voltage drops to a value below 35% of the nominal coil rating, the undervoltage trip device automatically opens the breaker. The operation is instantaneous, and the circuit breaker cannot be reclosed

until the voltage returns to 85% of line voltage. The undervoltage trip, which is continuously energized, must be energized before the circuit breaker can be closed.

Auxiliary Switch (AUX)

For applications requiring remote "on" or "off" indication (or electrical interlocking), auxiliary switches are available. Each switch comprises an "A" (open when circuit breaker is open) and a "B" (closed when circuit breaker is open) contact with a common connection. (Form C)

Alarm Switch (ALSW)

The alarm switch contact is closed when the circuit breaker is opened automatically by an overload, short circuit, shunt trip or undervoltage trip. The alarm switch contact is open when the circuit breaker is reset.

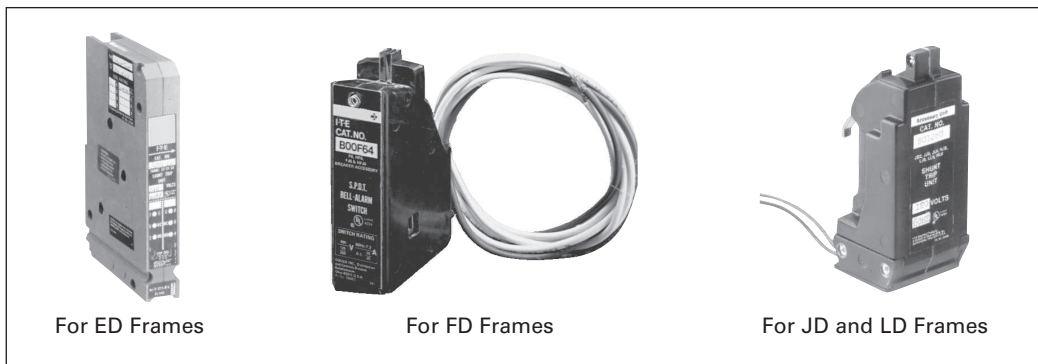

① Factory assembled only
② If mechanical interlock is installed, no accessory module can be installed in the right pocket.

③ If mechanical interlock is installed, no accessory module can be installed.
④ If mechanical interlock is installed, no accessory module can be installed in the left pocket.

⑤ Two accessory pockets in 3-pole breakers. One accessory pocket in 2-pole breakers

Molded Case Circuit Breakers

Circuit Breaker Accessories

Selection/ General

Circuit Breaker Accessories ④⑤⑥⑦⑧⑨

Catalog Number	For Use With Breaker Type	Number of Poles	Standard Package
Padlocking Device			
For locking breaker in "OFF" position. Note "ON" position does not affect breaker functionally			
ECPLD1	Type QP, BL, QAF2, QPF2, QE, QT-Duplex, BQ, BQXD	1P	3 Pieces
ECPLD1R	Type QP, BL, QAF2, QPF, QE, QT-Duplex, BQ, BQXD (Red Color)	1P	3 Pieces
ECPLD2	Type QP, BL, QAF2, QPF, QE, BQ, BQXD	2P	3 Pieces
ECPLD2R	Type QP, BL, QAF2, QPF, QE, BQ, BQXD (Red Color)	2P	3 Pieces
ECPLD3	Type QP, BL, QAF2, QPF, QE, BQ	3P	1 Piece
US2:ECPLD3R	Type QP, BL, QAF2, QPF, QE, BQ (Red Color)	3P	1 Piece
ECQLD3	Type QP, BL, BQ, BQXD	1P	10 Pieces
ECQLN3②	150-225 MBKA, QN, QNR	n/a	1 Piece
ECQTH4	Type QP, BL, BQH	Designed for (3) 1P Breakers	1 Piece
Handle Tie			
Provide simultaneous switching of 2 adjacent handles.			
ECQTH3	Type QP, BL	2P	50 Pieces
Mechanical Interlock①			
ECQML12	Type QP, BL, BQ Interlock Bracket	Designed for 1" Breaker	10 Pieces
Handle Blocking Device			
For holding breaker in "ON" or "OFF" position. Not a lockout/tagout device			
ECQL1	Type QP, BL, BQ, BQXD	1P	10 Pieces
Main Breaker Retainer			
ECMBR1③	EQ Load Centers		1 Piece
Mounting Accessories			
MB120	Type BQ, BQH Mounting Clips	1P	20 Pieces
FP9508	Type BQ, BQH FACE MOUNT PLATE	1P	10 Pieces
FP9555	Type BQ, BQH FACE MOUNT PLATE	2P	10 Pieces
FP9556	Type BQ, BQH FACE MOUNT PLATE	3P	10 Pieces
SMB6R	Type BQ MOUNTING BRACKET	1P, 2P, 3P	6 Pieces
TCH65K	Type BQ MOUNTING ADAPTER		500 Pieces
BR2	Type BQ, BQH, BQXD Back Mounting Plates	2P	10 Pieces
BR3	Type BQ, BQH, BQXD Back Mounting Plates	3P	10 Pieces
BR4	Type BQ, BQH, BQXD Back Mounting Plates	4P	10 Pieces
I0204ML1125CU	Type QP Back Mounting Plates	1P, 2P	10 Pieces
I0303ML3100CU	Type QP Back Mounting Plates	3P	10 Pieces
Replacement Lugs			
TA1Q1	Type BQ, NGG 100A Al Cu LGS	n/a	6 Pieces
TC1Q1	Type BQ, NGG 40A Al Cu LUGS	n/a	6 Pieces
Finger Shield			
BQFS1K	Type BQXD Finger Shield (Bulk Pack)	n/a	1000 Pieces
BQFS2	Type BQXD Finger Shield	n/a	2 Pieces
Filler Plate			
ECQF3	1" Filler Plate	n/a	5 Pieces

① For a complete list of standby power mechanical interlock kits, see page 1-25

② For use with Ultimate Load Center Main Breakers

③ Not suitable for use on 15-50A, 10 AIC Type QP Circuit Breakers

④ BL Type includes BLH, HBL

⑤ BQ Type includes BQH, HBO

⑥ QAF2 Type includes QAFH2, BAF2, BAFH2, QFGA2,

QFGAH2, BFGA2, BFGAH2

⑦ QPF Type includes QPHF, BLF, BLHF

⑧ QE Type includes QEH, BLE, BLEH

Molded Case Circuit Breakers

Circuit Breaker Accessories

General

Padlocking Device



ECPLD1



ECPLD2



ECPLD1R/2R/3R (Single pole pictured. 2-/3-pole available)

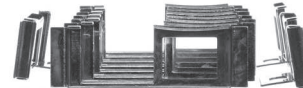

ECQLD3

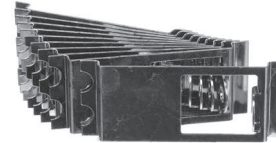

ECQLD4

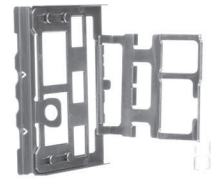

ECQTH4

Handle Tie



ECQTH2



ECQTH3

Handle Blocking Device

ECQL1

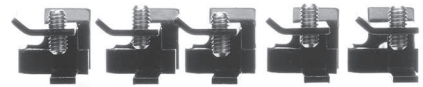

ECBX231M



Main Breaker Retainer



ECMBR1



ECMBR2

Mechanical Interlock

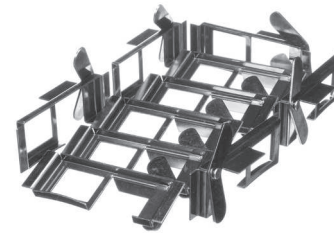

ECQML12

Mounting Accessories



MB120



SMB6R



I0204ML1125



FP9508



FP9555



FP9556

Molded Case Circuit Breakers

External Accessories

Selection

Handle Ties with Padlock Device

Provide simultaneous switching of 2 or 3 adjacent handles.
Do not provide common trip.

For Use With Breaker Frame(s)	Catalogue Number	Standard Package	Wt Lb/Std Pkg
BQD, NGB, HGB, LGB	BQDHT2	10	1/2
	BQDHT3	10	1/2

Padlocking Devices

For locking breaker in "OFF" position.

All QR	HPLQR	1	1/4
All BQD, CQD, NGB, HGB, LGB	BQDPLD	1	1/8
NGG, HGG, LGG	HPLG	1	1/4
EB, 1- thru 3-pole	HPLEB	1	1/8
All ED	ED2HPL	1	1/4
All FD	FD6PL1	1	1/4
All JD, LD, LMD	JD6HPL	1	1/4
All MD, ND, PD, RD	MN6PLD	1	1/4



Handle Blocking Devices

For holding breaker in "ON" or "OFF" position.
Not a lockout/tagout device.

All QR	HBLQR	1	1
All BQD, CQD, GG, GB	BQDHBD	1	1/4
All ED	E2HBL	1	1/4
All FD	FD6HB1	1	1/2
All JD, LD, LMD	JD6HBL	1	1/2
All MD, ND, PD, RD	MN6BL	1	1/2



Handle Extensions

For replacement. One extension shipped with breaker.

All MD, ND, PD, RD	EX11	1	2
--------------------	-------------	---	---

Terminal Shields

Breaker Type	Poles	Catalogue Number	Standard Package
NGG	3	TSSG3A	1
	1	TSSG61	1
HGG, LGG	2	TSSG62	1
	3	TSSG63	1



Ⓢ Sold only in standard package quantities.

Molded Case Circuit Breakers

External Accessories

Selection

Face Mounting Plates

For Use With Breaker Frame(s)	Number of Poles	Catalogue Number	Standard Package	Wt Lb/Std Pkg
CQD	1	CQDFMB1	1	1/4
	2	CQDFMB2	1	1/4
	3	CQDFMB3	1	1/4
NGG, HGG, LGG	1	FMPG1	1	1/4
	2	FMPG2	1	1/4
	3	FMPG3	1	1/4

Back Mounting Plates

ED2, ED4, ED6, HED4, HED6	1	E2BMB	1	1/4
---------------------------	---	-------	---	-----

Mounting Screw Kits

CQD	CQDSMK ^①	1	1 1/4
NGG, HGG, LGG	MSKG4	1	1/4
All QR	MSQR3	1	1/8
All ED (CED6 requires 2 kits)	MSE6 ^①	1	1/4
	MSE6100 ^②	100 ^③	1
All FD (CFD6 requires 2 kits)	MSF6 ^①	1	1/4
	MSF650 ^③	50 ^③	1
All JD, LD	MSJ6 ^①	1	1/4
All LMD	MSLMD	1	1/4
All MD, ND,	MSMN	1	1/4
All PD, RD	MSPR6	1	2

"MI" Mechanical Interlocks

For Use With Breaker Type(s)	Panel ^② Mounted	Plug-in Mounted	Standard Package	Wt Lb Std Pkg
All QR (Sliding Bar)	SBMIQR	—	1	1 1/2
All FD	MI5444	MI5444	1	—
All JD, LD	MI5413 ^④	—	1	1
All LMD	MI5406 ^⑤	—	1	1
All MD	MI5404 ^⑤	—	1	3
All ND	MI5404 ^⑤	—	1	3
All PD, RD	MI5405 ^⑤	—	—	—



^①Kit consists of 4 screws and washers.
^②Consists of 1 screw and washers (order 100).
^③Consists of 1 screw and washers (order 50).

^④With mechanical interlock in place, no accessory can be installed into circuit breaker right pole.
^⑤Addition of the mechanical interlock will prevent accessory installation in the left pole.
^⑥Sold only in standard package quantities. Multiply List Price Each times package quantity for full price.

^⑦Mechanical interlock is not designed for use within Siemens panelboards.

Molded Case Circuit Breakers

External Accessories

Selection

Rotary Door Mounted Operating Handles Types 1, 3, 3R, 12, 4 X

For Use With Breaker Frames	Complete Mechanism		Handle Only	Breaker Operator	Shaft Only	
	Catalog Number		Catalog Number	Catalog Number	Length (inches)	Catalog Number
	Standard Depth	Variable Depth				
ED ^①	CRHOESD	CRHOEVD	CRHOH ^②	RHOEBO	2	RHOSSD
FD	CRHOFSD	CRHOFVD		RHOFBO	12	RHOSVD
JD, LD	CRHOJSD	CRHOJVD		RHOJBO	16	RHOSXD
LMD	CRHOLMSD	CRHOLMVD		RHOLMBO		
MD, ND PD, RD	RHONSD	RHONVD	RHOH ^②	RHONBO ^②	3 12 24	RHONSSD RHONSVD RHONSXD

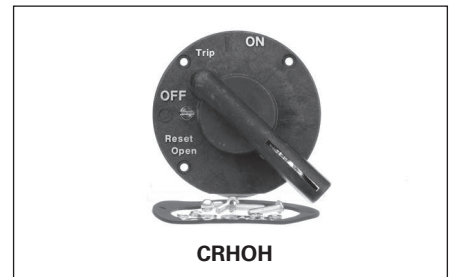

Rotary Door Mounted Operating Handles Types 1 & 12

For Use With Breaker Frames	Standard Depth Catalog Number	Variable Depth Catalog Number	Handle and Shaft Catalog Number	Breaker Operator Catalog Number
CQD, NGG, HGG, LGG	—	RHOCQVD	RHOH62 ^③	CQDOP
ED	D11CEU1	D11CEU2	—	—
FD	D11CFU1	D11CFU2	—	—
JD, LD	—	D11CJU2	—	—

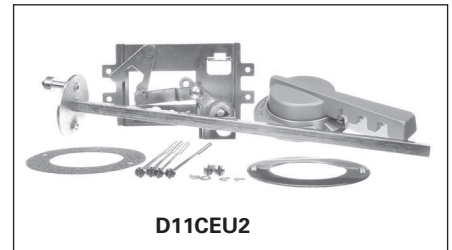

For CQD, NGG, HGG and LGG red emergency handle, order assembly **RHOCQVDE** (includes handle and operator).
For CQD, NGG, HGG and LGG in a NEMA 3R enclosure, order **CQDOP34** operator, **RHOH** handle and **RHOSVD** shaft.
For CQD, NGG, HGG and LGG in a NEMA 4 or 4X enclosure, order **CQDOP34** operator, **RHOH4** handle and **RHOSVD** shaft.

Through Door Mounted Operating Handles^④ Types 1 & 12

For Use With Breaker Frames	Standard Depth	Variable Depth
	Catalog Number	Catalog Number
CQD, NGG, HGG, LGG	FMHOS	—
ED	E2RH1	E2RHV9
FD	F6RH1	F6RHV9

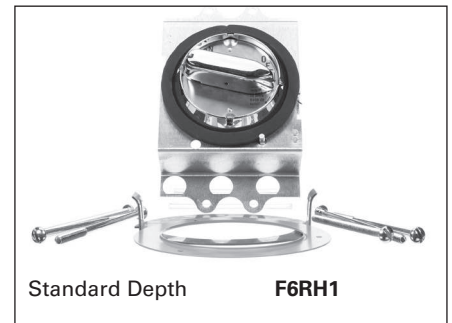

Door Latch Kits

Type	Catalog Number	Catalog Number
	Right Hand	Left Hand
2 point latch	DKR2	DKL2
3 point latch	DKR3	DKL3

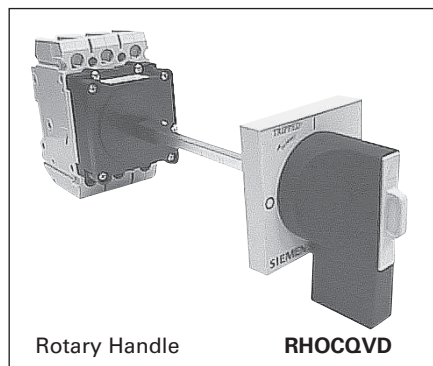
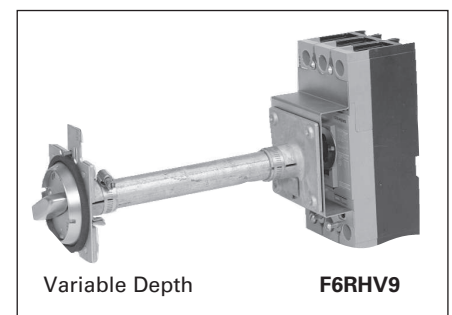

^① For use on 3-pole ED frame only.

^② Meets the requirements of NFPA 79, section 5.3.3.1 for locking external operator disconnecting devices.
^③ For 3 or 3R, order shaft and breaker operator as shown, and handle **RHOH**. For 4 & 4X, order handle **RHOH4**. Consult sales office for additional EG operator shaft lengths.

^④ For extended shaft support order catalog number **RHONSB2**.
^⑤ Length of shaft is 300mm (11.8 inches).

Molded Case Circuit Breakers

External Accessories

Selection

Max-Flex™, Flange Mounted Variable Depth Operators[®]

Frames	NEMA Type	Complete Kit Catalog Number	Handle Only Catalog Number	Breaker Operator Catalog Number	36" Cable Catalog Number
GG	1, 3 (R), 12	MFKG3R3	MFHG3R	MFMG	MFCF036
	4 (x)	MFKG4X3	MFHG4X		
ED	1, 3 (R), 12	FHOE036 [®]	FHOH	FHOEBO [®]	FHOEC036
	4 (x)	—	FHOH4		
FD	1, 3 (R), 12	FHOF036	FHOH	FHOFBO	FHOF036
	4 (x)	—	FHOH4		
JD, LD, SJD, SLD	1, 3 (R), 12	FHOJ036	FHOH	FHOJBO	FHOJC036
	4 (x)	—	FHOH4		
LMD	1, 3 (R), 12	FHOLM036 [®]	FHOH	FHOLMBO	FHOJC036
	4 (x)	—	FHOH4		
MD, ND, PD, RD, SMD, SND, SPD	1, 3 (R), 12	FHON048	FHOHN	FHONBO	FHONC048 [®]
	4 (x)	—	FHOHN4		

Max-Flex™ handles are available with solid black handles instead of the customary “red for on” flange handle. These are preferred for use in IEC markets, where red handles have specific meaning. Order components separately, appending the letter “i” to the catalog number (e.g. FHOHI).

Alternate Length Cable Only

Inches	ED Catalogue Number	FD Catalogue Number	JD/LD/LMD Catalogue Number	MD/ND/PD/RD Catalogue Number
48	FHOEC048	FHOF048	FHOJC048	FHONC048
60	FHOEC060	FHOF060	FHOJC060	FHONC060
72	FHOEC072	FHOF072	FHOJC072	FHONC072
96	FHOEC096	FHOF096	FHOJC096	FHONC096
120	FHOEC120	FHOF120	FHOJC120	FHONC120
144	FHOEC144	FHOF144	FHOJC144	FHONC144

Handle Auxiliary Switch

For use with Max-Flex and Rotary Door operators (FHOH and RHOH). 1 NO and 1 NC contact (Form C).

For Use With	Catalogue Number
ED, FD, JD, LD, LMD, ND, PD, RD, SD, Max Flex	HAS1

Fixed Depth Flange Mounting

Frames	Minimum Enclosure Depth	NEMA Type	Left Hand Mount	Right Hand Mount
			Catalogue Number	Catalogue Number
ED [®]	6.44	1, 3R, 12	FDFBEL	DFBFR
			FDFBEL4	DFBFR4
FD	6.44	1, 3R, 12	FDFBFL	DFBFR
			FDFBFL4	DFBFR4

Max-Flex™ handles are available with solid black handles instead of the customary “Red for On” flange handle. These are preferred for use in IEC markets, where red handles have specific meaning. Order components separately, appending the letter “i” to the catalog number (e.g. FHOHI).

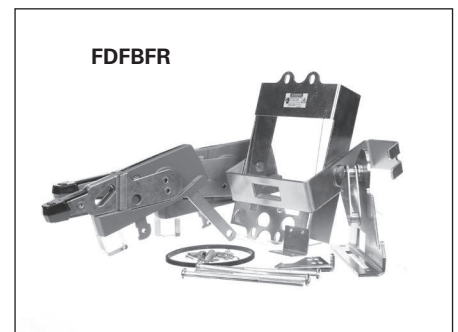
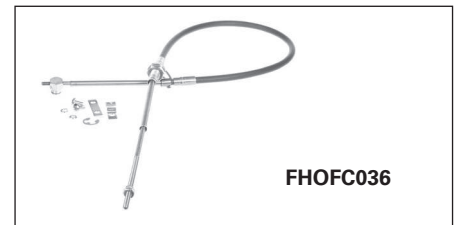

[®] For 1- or 2-pole breaker order FHOED036 complete kit or FHOEDBO breaker operator only. Use MFHM3R handle.

[®] 48 inch cable is standard length for M through R frame Max-Flex operators.

[®] Meets requirements of NFPA 79, section 5.3.3.1 for locking external operator disconnecting devices

[®] Consult sales office for additional cable lengths for EG Flex Shaft Operators. For 3-Pole only.

[®] 3-Pole ED only.

[®] FHOLM048 is available for a 48 inch handle kit.

Molded Case Circuit Breakers

External Accessories

Selection

Telemand® Motor Operator

Breaker Frame	AC Voltage	Hinged to Open Down
ED except CED	120	MOE6120
	120	MOE6240

ED motor operator opens downward.

Breaker Frame	DC Voltage	Hinged to Open Right	AC Voltage	Hinged to Open Right
FD	24	MOF6024DC	120	MOF6120
	48	MOF6048DC	240	MOF6240
	125	MOF6125DC	—	—
JD, LD	24	MOJ6024DC	120	MOJ6120
	48	MOJ6048DC	240	MOJ6240
	125	MOJ6125DC	—	—
LMD	24	MOLMD6024DC	120	MOLMD6120
	48	MOLMD6048DC	240	MOLMD6240
	125	MOLMD6125DC	—	—
MD, ND, PD, RD	—	—	120	EMOPL120MN
	—	—	240	EMOPL240MN

To order FD through RD motor operators with Left side hinges, add "L" to catalogue number (e.g. MOF6120L).

Dimensions

Frame	A	B	C	D	E	F
ED	7.04	4.31	—	4.31	13.84	8.84
FD	9.50	4.55	1.60	6.84	9.70	7.58
JD, LD, LMD	11.00	7.50	0.79	8.34	9.85	7.74
MD, ND, PD, RD	16.00	9.00	—	9.83	13.13	10.13

Operating Currents

Catalogue Number	On			Off			Reset (Amps)
	In-Rush (Amps)	Running (Amps)	Time (msec)	In-Rush (Amps)	Running (Amps)	Time (msec)	
MOE6120	10.25	2.3	550	10.0	2.3	400	2.3
MOE6240	5.2	1.1	500	5.0	1.0	330	1.1
MOF6120/L	10.0	5.5	200	10.0	5.5	175	5.5
MOF6240/L	4.7	2.5	200	4.7	2.5	185	2.5
MOLMD6120/L	15.2	6.0	210	15.2	6.0	185	6.0
MOJ6120/L	15.2	6.0	210	15.2	6.0	185	6.0
MOJ6240/L	5.0	2.5	217	5.0	2.5	185	2.5
MOMN6120/L	22.7	13.9	240	22.7	13.9	210	13.9
MOMN6240/L	12.6	4.6	260	12.6	4.6	230	12.6



FD, JD, LD, LMD, MD, ND, PD, RD Frames

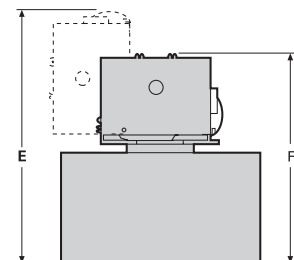
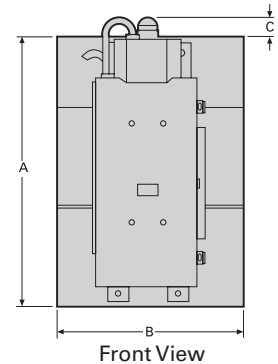

For inches / millimeters conversion, see Technical section.

Molded Case Circuit Breakers

External Accessories

Plug-In Mounting Assemblies, Including Base and Tulip Assemblies

For Use With Breaker Frames	Poles	Line Side	Load Side	Steel Switchboard Mounting Plate ^① Catalogue Number
		Catalogue Number ^②	Catalogue Number ^②	
All ED except CED	2	PC2637	PC2638	PL2616
	3	PC2657	PC2658	
CED	2	PC2637	PC2638	PL2617
	3	PC2657	PC2658	
All FD except CFD	2	PC4753	PC4753	PL4762
	3	PC4754	PC4754	
CFD	2	PC4753	PC4753	PL4763
	3	PC4754	PC4754	
All JD except CJD	2	PC5777	PC5777	PL5796
	3	PC5778	PC5778	
Kit CJD, SCJD	3	PCCJD	PCCJD	PL5797
All LD except CLD	2	PC5660	PC5660	PL5696
	3	PC5661	PC5661	
Kit CLD, SCLD	3	PCCLD	PCCLD	PL5797
All MD	2	PC5662	PC5662	PL9698
	3	PC5663	PC5663	
All ND	2	PC5664 ^③	PC5664c	PL9699
	3	PC5666 ^③	PC5666 ^③	

Selection/Dimensions

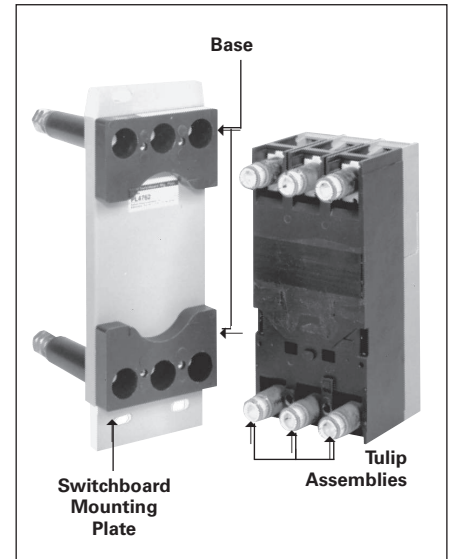

Tulip Assemblies Separately

For Frame	2 Pole	3 Pole
	Catalogue Number	Catalogue Number
ED	TCE2	TCE3
FD	TCF2	TCF3
JD	TCJ2	TCJ3
LD	TCL2	TCL3
MD	TCM2	TCM3
ND	TCN2	TCN3

Rear-Connecting Studs

For Use With Breaker Frames	Ampere Rating	Description	Extension Behind Breaker (inches)	Line Side	Load Side
				Catalogue Number	Catalogue Number
All ED	100	Line Side (Short)	2.38	RS2643 ^④	—
	100	Load Side (Short)	2.38	—	RS2644 ^④
	100	Line Side (Long)	4.88	RS2641 ^④	—
	100	Load Side (Long)	4.88	—	RS2642 ^④
All FD	250	Short Long	3.12	RS4756 ^④	RS4756 ^④
	250		7.06	RS4755 ^④	RS4755 ^④
All JD	400	Short Long	5.85	RS5774	RS5774
	400		11.20	RS5773	RS5773
All LD	600	Short Long	5.85	RS5784	RS5784
	600		11.20	RS5783	RS5783
CJD, SCJD CLD, SCLD	Add required shield kit.		—	—	CLRSJL3
LM(X)D6, HLM(X)D6	800	Short Long	5.85	RS5788	RS5788
			11.20	RS5787	RS5787
All MD, ND	1200	Short Long	5.50	RS5786	RS5786
	1200		8.00	RS5785	RS5785

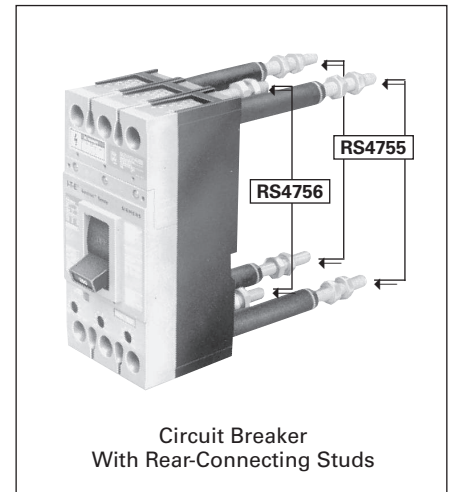

① Furnished at no extra charge when ordered with plug-in mounting assembly.
② Each piece catalogue number consists of (1) mounting block assembly and required tulip assemblies (2) for 2-pole, (3) for 3-pole

③ For vertical bus mounting — for horizontal, substitute PC5665 for PC5664 and PC5667 for PC5666.
④ Price includes one current stud, insulating tube, stud nuts and terminal shields, when required.

⑤ For proper electrical clearance, studs must alternate between short and long stud lengths on circuit breaker poles (e.g. SLSLSL or LSLSL).

Molded Case Circuit Breakers

Unusual Operating Conditions

Reference

Note: The information provided on this and the next page is intended for reference and recommendation only. Because several variables can act on a circuit breaker's performance at the same time, the data below is based less on controlled testing, than on experience and engineering judgment. Contact Siemens for further information on special conditions and treatment.

High Ambient Temperatures

Because thermal-magnetic trip breakers are temperature sensitive and calibrated for a specific ambient of 40° C (104° F) (average enclosure temperature), a higher ambient will cause the breaker to trip at lower current than its nameplate rating, in other words, causing the breaker to "derate" (see Table 1). Similarly, the current carrying capacity of a circuit conductor is based upon a certain ambient temperature, a higher ambient will reduce its current carrying capacity, causing it to "derate." Thus, with a fluctuating temperature, a thermal-magnetic breaker will derate nearly parallel with its connected circuit conductors and maintain close circuit protection. If the application temperature exceeds 40° C (104° F) and is known, either a breaker specially calibrated for the higher ambient or one oversized according to Table 1 may be selected.

In a case such as this, the circuit conductors should be oversized as well.

Siemens Sensitrip® III and Type SB Encased Systems Breakers are insensitive to temperature changes. However, they do include circuitry to protect the components from abnormally high temperatures.

Moisture – Corrosion

For atmospheres having high moisture content and / or where fungus growth is prevalent, a special preventive treatment may be required.

Where the air is heavily laden with corrosive elements, breakers made with special corrosion-resistant finishes may be required.

Altitude

Reduced air density at altitudes greater than 6600 ft. (2000 meters) affects the ability of a molded case circuit breaker to transfer heat and interrupt faults. Therefore, circuit breakers applied at these altitudes should have interrupting, insulation and continuous currents derated as indicated in Figure 1.

Table 1 – Temperature Derating Data for Thermal-Magnetic Breakers

Reference Ampere Rating at 40° C (104° F)	Ampere Rating at:			Siemens Breaker Frames
	25° C (77° F)	50° C (122° F)	60° C (140° F)	
15	17	13	11	ED
20	22	18	16	
25	28	23	21	
30	33	28	26	
35	39	30	25	
40	44	37	34	
50	55	46	42	
60	66	56	52	
70	77	65	60	
90	99	84	78	
100	110	94	87	
125	137	114	100	
150	165	136	120	
175	192	159	140	
200	220	182	160	
225	247	205	180	
250	275	235	220	
300	330	276	252	
350	385	325	301	
400	440	372	340	
500	550	468	435	
600	660	564	525	
700	770	658	613	
800	880	754	704	
900	990	828	749	
1000	1100	900	825	
1200	1320	1090	1000	
1400	1540	1304	1148	
1600	1760	1500	1320	
1800	1980	1690	1485	
2000	2200	1880	1650	
				QJ
				FD
				JD
				LD
				MD
				ND
				PD
				RD

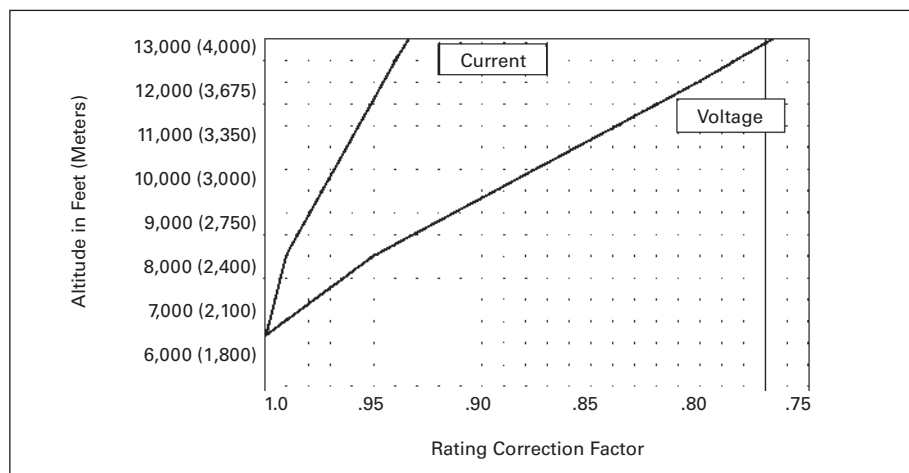

Figure 1 – Altitude Adjustment

Molded Case Circuit Breakers

Unusual Operating Conditions

Reference

400 Hz Systems^①

Siemens molded case circuit breakers can be applied for overcurrent protection on 400Hz systems, commonly used to power computer installations, aircraft, military and other specialty equipment. Below are basic guidelines.

Circuit Breaker Derating Required

This table lists the maximum continuous current carrying capacity for Siemens breakers at 400Hz. Due to the increased resistance of the copper sections resulting from the skin effect produced by eddy currents at these frequencies, circuit breakers in many cases require derating. The thermal derating on these devices is based upon 100%, three-phase application in open air in a maximum of 40° C (104° F) with 48 in. (1219 mm) of the specified cable or bus at the line and load side. Additional derating of not less than 20% will be required if the circuit breaker is to be utilized in an enclosure. Further derating may be required if the enclosure

ambient temperature exceeds 40° C (104° F).

Cable and Bus Sizing

The cable and bus sizes to be utilized at 400Hz are not based on standard National Electric Codes tables for 60Hz application. Larger cross sections are necessary at 400Hz. All bus bars specified are based upon mounting the bars in the vertical plane to allow maximum air flow. All bus bars are spaced at a minimum of 0.25 in. (6mm) apart. Mounting of bus bars in the horizontal plane will necessitate additional drafting. Edgewise orientation of the bus may change the maximum ratings indicated. If additional information is required for other connections of cable or bus, contact Siemens for information.

Application Recommendations

It is recommended that temperatures be measured on the line and load terminals or T-connectors of the center pole. These

are usually the hottest terminals with a balanced load. A maximum temperature of 75° C (35° C over a maximum ambient of 40° C) would verify the particular application. Temperature profiles taken on these breakers can be correlated to ensure that the hottest points within the breaker are within the required temperature limits.

Factory Configuration

When required, molded case circuit breakers may be factory calibrated for 400Hz application. These breakers are specially labeled for 400Hz usage and their nameplate current rating will include the necessary derating factor. The highest "Maximum Continuous Amperes" rating at 400Hz, found in the table below approximates the highest specially calibrated 400Hz nameplate ampere rating available for a given frame size. Contact Siemens for ordering information on other breakers applied in 400Hz systems.

400Hz Breakers

Siemens Breaker Type	Maximum Continuous Ampere Rating At 40° C (104° F) ^②			75° C (167° F) Copper Cable per Pole	
	60HZ	400HZ	Enclosed After Derating	No of Pieces	Wire Size
	Open Air	Open Air ^③			
ED2, ED4, ED6, HED4, CED6	15	15	12	1	#14
	20	20	16	1	#12
	25	25	20	1	#10
	30	30	24	1	#10
	35	35	28	1	#10
	40	40	32	1	#8
	45	43	34	1	#8
	50	48	38	1	#8
	60	57	46	1	#6
	70	67	54	1	#4
	80	76	61	1	#4
	90	86	69	1	#3
	FD6, FXD6, HFD6, HFXD6, CFD6	100	95	76	1
110		105	84	1	#2
125		119	95	1	#1
70		63	50	1	#4
80		72	58	1	#4
90		80	64	1	#3
100		90	72	1	#3
110		95	75	1	#2
125		105	84	1	#1
150		125	100	1	#1/0
JXD2, JD6, JXD6, HJD6, HJXD6, HHJD6, HHJXD6, CJJD6	175	140	112	1	#2/0
	200	160	128	1	#3/0
	225	180	144	1	#4/0
	250	200	160	1	250 kcmil
	200	170	136	1	#3/0
	225	190	152	1	#4/0
	250	210	168	1	250 kcmil
	300	240	192	1	350 kcmil
JD6, JXD6, HJD6, HJXD6 100% Rated	350	260	208	1	500 kcmil
	400	300	240	2	#3/0
	200	170	170	2	#3/0
	225	190	190	2	#4/0
	250	210	210	1	250 kcmil

Siemens Breaker Type	Maximum Continuous Ampere Rating At 40° C (104° F) ^②			75° C (167° F) Copper Cable per Pole	
	60HZ	400/415HZ	Enclosed After Derating	No of Pieces	Wire Size
	Open Air	Open Air ^③			
LD6, LXD6, HLD6, HLXD6, HHL6, HHLXD6, CLD6	250	210	168	1	250 kcmil
	300	240	192	1	350 kcmil
	350	260	208	1	500 kcmil
	400	300	240	2	#3/0
	450	340	272	2	#4/0
	500	375	300	2	250 kcmil
	600	420	336	2	350 kcmil
LD6, LXD6, HLD6, HLXD6, 100% Rated	250	210	210	1	250 kcmil
	300	240	240	1	350 kcmil
	350	260	260	1	500 kcmil
	400	300	300	2	#3/0
	450	340	340	2	#4/0
	500	375	375	2	250 kcmil
	600	420	420	2	350 kcmil
MD6, MXD6, HMD6, HMXD6, CMD6	500	400	320	2	250 kcmil
	600	430	360	2	350 kcmil
	700	500	400	3	250 kcmil
	800	560	448	3	300 kcmil
MD6, MXD6, HMD6, HMXD6, CMD6 100% Rated	500	400	400	2	250 kcmil
	600	430	430	2	350 kcmil
	700	500	500	3	250 kcmil
	800	560	560	3	300 kcmil
ND6, NXD6, HND6, HNXD6, CND6	800	560	448	3	300 kcmil
	900	600	480	3	350 kcmil
	1000	650	520	3	400 kcmil
	1200	780	624	4	350 kcmil
ND6, NXD6, HND6, HNXD6, CND6	900	600	600	3	350 kcmil
	1000	650	650	3	400 kcmil
	1200	780	780	4	350 kcmil
	1200	780	624	4	400 kcmil
PD6, PXD6, HPD6, HPXD6, CPD6, 100% Rated	1400	850	680	4	500 kcmil
	1600	960	768	5	500 kcmil
	1200	780	780	4	400 kcmil
PD6, PXD6, HPD6, HPXD6, CPD6	1400	850	850	4	500 kcmil
	1600	960	960	5	500 kcmil
	1600	960	768	5	500 kcmil
RD6, RXD6, HRD6, HRXD6 80% Rated	1800	1080	864	5	500 kcmil
	2000	1200	960	6	500 kcmil

^①The information provided on this page is intended for reference and recommendation only. Because several variables can act on a circuit breaker's performance at the same time, the data above is based less on

controlled testing, than on experience and engineering judgment. Contact Siemens for further information on special conditions and treatment.

^②Additional derating may be required if the ambient temperature is greater than 40° C (104° F).





^③Calculated after derating to compensate for the heating of the copper conductor, caused by the skin effect generated by eddy currents produced at 400/415Hz.

VL Circuit Breakers

Technical Overview

Technical

Frame Summary and Ratings Table

Frame Family		DG	FG	JG
				
Continuous Ampere Range		30 to 150A	40 to 250A	70 to 400A
Number of Poles		2, 3	2, 3	2, 3
Maximum Voltage Rating		600Y/347	600Y/347	600Y/347
Type of Protection				
Thermal-Magnetic		◆	◆	◆
Electronic		◆	◆	◆
Electronic with LCD		◆	◆	◆
Motor Circuit Protector		◆	◆	◆
Molded Case Switch		◆	◆	◆
100% Rated 400/500 Amp		ETU only	—	◆
Interchangeable Trip Unit		—	—	◆
	W In.(mm)	4.1 (105)		5.5 (139)
	H	7.3 (175)		11 (279)
	D	3.4 (81)		4.2 (102)
	D1	4.2 (107)		5.4 (138)
Type N – Normal Interrupting Rating^①, RMS Symmetrical Amperes (kA)				
CSA / UL	240Vac	65	65	65
	480Vac	35	35	35
	600Vac ^②	18	18	25
IEC (I_{CU}/I_{CS})	240Vac	65/65	65/65	65/65
	415Vac	40/40	40/40	45/45
	690Vac	12/6	12/6	12/6
DC Voltages – Interrupting Rating (kA)^③				
	250Vdc - 2p	30	30	30
	500Vdc - 3p ^②	18	18	25
Type H – High Interrupting Rating^①, RMS Symmetrical Amperes (kA)				
CSA / UL	240Vac	100	100	100
	480Vac	65	65	65
	600Vac ^②	18	18	25
IEC (I_{CU}/I_{CS})	240Vac	100/75	100/75	100/75
	415Vac	70/70	70/70	70/35
	690Vac	12/6	12/6	15/8
DC Voltages – Interrupting Rating (kA)^③				
	250Vdc - 2p	30	25	25
	500Vdc - 3p ^②	35	50	50
Type H – Very High Interrupting Rating^①, RMS Symmetrical Amperes (kA)				
CSA / UL	240Vac	200	200	200
	480Vac	100	100	100
	600Vac ^②	18	18	25
IEC (I_{CU}/I_{CS})	240Vac	200/150	200/150	200/150
	415Vac	100/75	100/75	100/75
	690Vac	12/6	12/6	15/8
DC Voltages – Interrupting Rating (kA)^③				
	250Vdc - 2p	30	30	30
	500Vdc - 3p ^②	35	30	35

① CSA / UL does not recognize AIC ratings for Molded Case Switches or Motor Circuit Protectors.
② 500Vdc nominal, for ungrounded DC UPS systems.





③ DC Interruption Ratings do not apply to electronic trip circuit breakers.
④ DG & FG breakers are 600Y/347V.

VL Circuit Breakers

Technical Overview

Technical

Frame Summary and Ratings Table — Continued

Frame Family		LG	MG	NG	PG
					
Continuous Ampere Range		150 to 600A	200 to 800A	300 to 1200A	400 to 1600A
Number of Poles		2, 3	2, 3	2, 3	3
Maximum Voltage Rating		600V	600V	600V	600V
Type of Protection					
Thermal-Magnetic		◆	◆	◆	◆
Electronic		◆	◆	◆	◆
Electronic with LCD		◆	◆	◆	◆
Motor Circuit Protector		◆	◆	◆	—
Molded Case Switch		◆	◆	◆	◆
100% Rated 400/500 Amp		400/500 Amp	◆	◆	◆
Interchangeable Trip Unit		—	◆	◆	◆ [Ⓞ]
	W In.(mm)	5.5 (139)	7.5 (190)		9 (229)
	H	11 (279) [Ⓞ]	16 (406)		16 (406)
	D	4.2 (102)	4.7 (114)		6.2 (157)
	D1	5.4 (138)	5.9 (151)		8.1 (207)
Type N – Normal Interrupting Rating[Ⓞ], RMS Symmetrical Amperes (kA)					
CSA / UL	240Vac	65	65	65	65
	480Vac	35	35	35	35
	600Vac	18	25	25	25
IEC (I_{CU}/I_{CS})	240Vac	65/65	65/65	65/65	65/65
	415Vac	45/45	50/50	50/25	50/25
	690Vac	12/6	20/10	20/10	20/10
DC Voltages – Interrupting Rating (kA)[Ⓞ]					
	250Vdc - 2p	30	22	22	22
	500Vdc - 3p [Ⓞ]	25	35	35	35
Type H – High Interrupting Rating[Ⓞ], RMS Symmetrical Amperes (kA)					
CSA / UL	240Vac	100	100	100	100
	480Vac	65	65	65	65
	600Vac	18 [Ⓞ]	35	35	35
IEC (I_{CU}/I_{CS})	240Vac	100/75	100/75	100/75	100/50
	415Vac	70/70	70/70	70/35	70/35
	690Vac	15/8	30/15	30/15	30/15
DC Voltages – Interrupting Rating (kA)[Ⓞ]					
	250Vdc - 2p	30	25	25	25
	500Vdc - 3p [Ⓞ]	35	50	50	50
Type H – Very High Interrupting Rating[Ⓞ], RMS Symmetrical Amperes (kA)					
CSA / UL	240Vac	200	200	200	200
	480Vac	100	100	100	100
	600Vac	18	50	65	65
IEC (I_{CU}/I_{CS})	240Vac	200/150	200/150	200/150	200/150
	415Vac	100/75	100/75	100/75	100/75
	690Vac	15/8	35/17	35/17	35/17
DC Voltages – Interrupting Rating (kA)[Ⓞ]					
	250Vdc - 2p	30	42	42	42
	500Vdc - 3p [Ⓞ]	35	65	65	65

5
MOLDED CASE
CIRCUIT BREAKERS

Ⓞ CSA / UL does not recognize AIC ratings for Molded Case Switches or Motor Circuit Protectors.
Ⓞ 25kA available in a special version. Standard breakers rated 18kA. See page 5-213.

Ⓞ 500Vdc nominal, for ungrounded DC UPS systems.
Ⓞ DC Interruption Ratings do not apply to electronic trip circuit breakers.
Ⓞ Thermal-magnetic available non-interchangeable only.

Ⓞ 13.6" with extended shields.

VL Circuit Breakers

Trip Unit Overview

Selection

The interchangeability of the VL circuit breaker trip units allow for easy conversion from any of 3 types of protection. They are thermal-magnetic, electronic, or electronic with a built-in LCD display. The thermal-magnetic trip unit features an adjustable magnetic trip setting. The electronic trip units are microprocessor based true RMS sensing devices and are available with a variety of adjustable trip settings, configurations, and information menus.

With precise control over the circuit breaker functions and access to system status, diagnostics, and information, these trip units allow for unsurpassed flexibility in circuit coordination.

An example of coordination is the out of the box Ground Fault function on the Model 555 trip units. The pick-up and time delay settings are set at the factory for each frame and do not overlap

with the settings on the other frames. Therefore, when VL breakers are used together in a system the GF protection is automatically coordinated.

The user also has the ability to program a custom coordination scheme with adjustable settings on both the 555 and 586 trip units.

Trip Unit Functions	VL Trip Units							
	Model 525	Model 555				Model 586		
	Thermal-magnetic	Electronic LI	Electronic LIG	Electronic LSI	Electronic LSIG	Electronic with LCD LSI	Electronic with LCD LSIG	Electronic with LCD LSI + G alarm only
Continuous Current Setting (I_r)	Fixed	◆	◆	◆	◆	◆	◆	◆
Long Time Delay (t_r)	□	◆	◆	◆	◆	◆	◆	◆
Instantaneous Function	●	●	●	●	●	(ON/OFF)	(ON/OFF)	(ON/OFF)
Instantaneous Pickup (I_i)	◆	◆	◆	◆	◆	◆	◆	◆
Short Time Function	□	□	□	●	●	(ON/OFF)	(ON/OFF)	(ON/OFF)
Short Time Pick-up (I_{sd})	□	□	□	◆	◆	◆	◆	◆
Short Time Delay (t_{sd})	□	□	□	◆	◆	◆	◆	◆
Ground Fault Pick-up (I_g)	□	□	◆	□	◆	□	◆	□
Ground Fault Delay (t_g)	□	□	◆	□	◆	□	◆	□
Ground Fault Alarm Pick-up	□	□	□	□	□	□	◆	◆
Ground Fault Alarm Delay	□	□	□	□	□	□	◆	◆
Alarm & Status Indicator	□	●	●	●	●	●	●	●
Built-in Display (LCD)	□	□	□	□	□	●	●	●
Pre-Trip Alarma	□	●	●	●	●	●	●	●
Last Trip Information ^①	□	●	●	●	●	●	●	●
Zone Selective ^①	□	●	●	●	●	●	●	●
Communications ^①	□	●	●	●	●	●	●	●

- ◆ Adjustable setting
- This feature is included
- Feature is not included.

① Requires a **COMPRO20** or **COMM0D21** module in a communication system.

Continuous Amps Rating (I_r)

This setting is the continuous current that the breaker will carry without tripping. It can be set up to 100% of the trip unit's nominal rating (I_n).

Long Time Delay (t_r)

Sometimes referred to as the "overload" position, this function controls the breaker's "pause-in-tripping" time. It allows low level, temporary inrush currents such as those encountered when starting a motor to pass without tripping. The time delay begins when the current reaches $6 \times I_r$.

Instantaneous Pick-up (I_i)

This function sets the breaker to trip instantaneously during high fault conditions. This function may be turned off on Model 586 trip units.

Short Time Pick-Up (I_{sd})

This function controls the level of fault current the breaker will carry for a short time without tripping, thus allowing downstream devices to clear short circuits ahead of up-stream protection. It may be defeated (turned-off) on Model 586 trip units.

Short Time Delay (t_{sd})

This controls the interval of time the breaker will remain closed against a fault (at the Short Time Pick-up current level) without tripping. The time delay may be set at fixed points or at short time intervals based on I^2t curves. This function is used with the Short Time Pick-up to achieve selectivity and better system coordination.

Ground Fault Pick-Up (I_g)

This setting controls the level of ground fault current that will cause the breaker to trip. Model 555 Electronic Trip Units act on the residual current to sense ground current. The Model 586 Electronic Trip Unit is programmable and allows the user to select either the residual current method or direct detection (via a separate current transformer) to detect ground current.

Ground Fault Time Delay (t_g)

This controls the interval of time the breaker will remain closed after a ground fault is detected (at the Ground Fault Pick-up current level) without tripping.

VL Circuit Breakers

General Information

Selection

Thermal-Magnetic trip units, Model 525, combine the inverse time element design for low level overloads, and instantaneous magnetic action for short circuit protection. The standard unit has preset overload protection and an adjustable instantaneous trip setting, with 6 set points. Thermal-Magnetic trip units are available throughout the VL family, from 30 to 1600A.

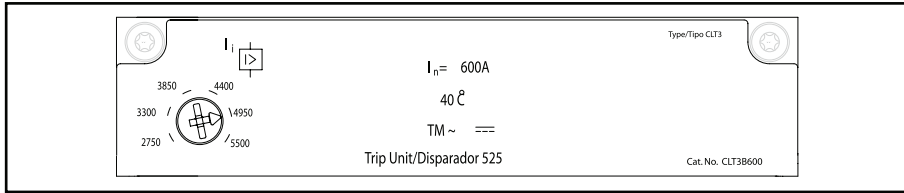

Electronic Trip Units

Electronic trip units are available through the VL family, from 60A (which can be set as low as 30A) up through 1600A. They are also available in four trip configurations (LI, LIG, LSI, LSIG) and features can include a built-in LCD display.

microprocessor is in operating and another indicates an overload condition. For ease-of-use and to insure proper coordination, the set points for the continuous current are shown on the face of these trip units in amps.

On the Model 555 Electronic Trip Unit a flashing LED confirms that the

On the Model 586, the LCD version, the current in each phase is continuously shown on the display. Unlike many

displays, no secondary or auxiliary voltage is required as long as the breaker is energized and a minimal load current is present. These trip units can also indicate the "last trip" status (date, time, amps) when they're connected to a PC via one of our communications modules. Without being connected via a communication module, the last trip status can be viewed on Model 586 trip units (no time stamp).

Typical Trip Unit Labeling and Adjustment Positions

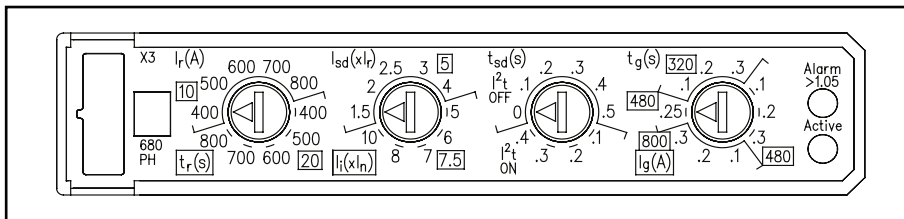

Model 555 Electronic Trip Unit with LSIG trip functions

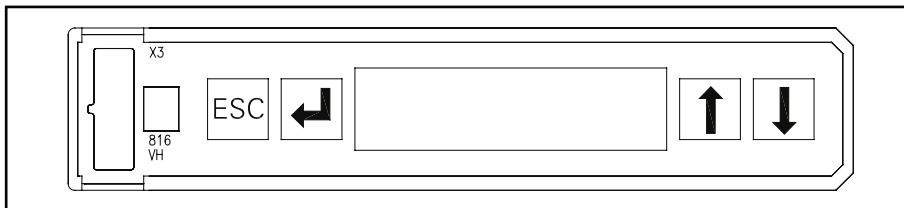

Model 586 Electronic Trip Unit has an LCD display

VL Circuit Breakers

DG 150A Frame, VL Series

Selection

Ordering Information

Complete Assembled Breaker

A complete factory assembled DG breaker includes the frame, trip unit, and standard line and load connectors, all factory installed and shipped as a complete breaker. Assembled breakers are only available with standard connectors.

For any other configuration, order the frame, trip unit, and terminals as separate items.

For DC applications, use thermal magnetic trip unit only.

For reverse feed applications, select non-interchangeable trip breakers only. For non-interchangeable trip breakers, change the third digit of the catalogue number to "X" for standard breakers.

For special applications, refer to page 5-216.

Mounting hardware is included with each frame or complete breaker.

For 100% rated breakers with a non-interchangeable trip unit, change the 3rd character of the catalogue number to "Y". Available in electronic and electronic with LCD only.

HACR rated.

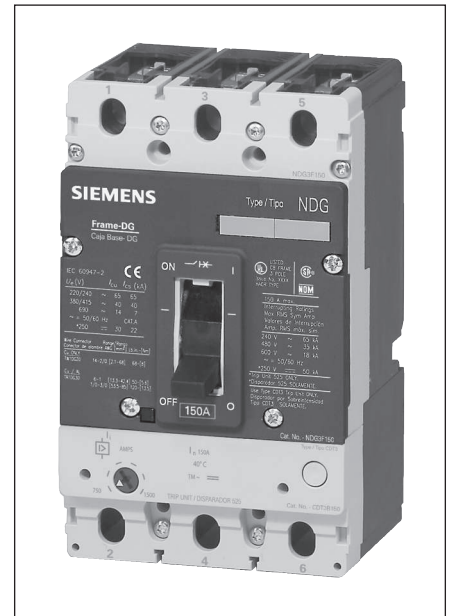

Interrupting Ratings

Breaker Type	RMS Symmetrical Amperes (KA)										
	UL 489					IEC 60947-2					
	Volts AC (50/60 Hz)			Volts DC		Volts AC (50/60 Hz)					
	240	480	600	250	500	220/240		380/415		690	
					ICU	ICS	ICU	ICS	ICU	ICS	
NDGA	65	35	18	30	18	65	65	40	40	12	6
HDGA	100	65	20	30	18	100	75	70	70	12	6
LDGA	200	100	25	30	18	200	150	100	75	12	6

Dimensions - Inches (mm)

Number of Poles	W	L	D	To Handle D1
2, 3	4.1 (105)	6.9 (175)	3.4 (81)	4.2 (107)

Connectors for 75°C Wire

Construction	Ampere Rating	Wire Range	No. of cables per connector	Catalogue Number
Steel	30-150	#8-1/0 Cu	1	3TW1DG20 ^②
Aluminum	30-150	#6-3/0 Al/Cu	1	3TA1DG30 ^{②③}
Copper	30-150	#6-3/0 Cu	1	3TC1DG30 ^{②④}
Distribution Lugs				
	30-150	#14-#2 Cu (3pcs. Max)	3	3TA3DG02 ^②
	30-150	#14-#4 Cu	6	3TA6DG04 ^②
Compression Lugs				
	30-150	#14-2/0 kcmil Al/Cu	-	2CLD20 ^③
	30-150	#14-2/0 kcmil Al/Cu	-	3CLD20 ^③

- ① Standard connector supplied with complete breakers.
- ② Kit consists of 3 terminal connectors.
- ③ 2 Lugs for 2-pole breakers.
- ④ Required for 100% rated DG breakers. Requires 90°C cable sized at 75°C ampacity

DG Thermal-Magnetic, Instantaneous Trip Adjustment Range

Trip Unit Continuous Amp Rating (I _n)	Instantaneous Overcurrent Setting (I _s)	
	Min.	Max.
50	450	700
60	450	700
70	450	700
80	450	800
90	500	1000
100	500	1000
110	550	1100
125	625	1250
150	800	1600

Note: Each breaker has 6 trip settings in this range.

Approx. Shipping Weight, lbs. (kg)

Poles	Frame	Trip Unit		Complete Breaker
		Thermal-Mag.	Electronic	
2, 3	3.7 (1.7)	2.2 (1.0)	2.6 (1.2)	5.9 (2.7)

External Accessories page 5-195 - 5-209

VL Circuit Breakers

DG 150A Thermal-Magnetic Trip Unit

Selection

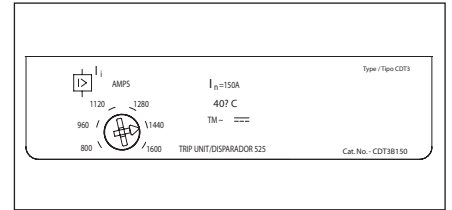

Model 525 Trip Unit

DG 150A Frame 2-Pole with Thermal-Magnetic Trip Unit

Continuous Ampere Rating	N-Interrupting Class	H-Interrupting Class	L-Interrupting Class	Catalogue Number
	Catalogue Number	Catalogue Number	Catalogue Number	
	FRAME ONLY			
	NDG2F150	HDG2F150	LDG2F150	
COMPLETE FACTORY ASSEMBLED CIRCUIT BREAKER				TRIP UNIT ONLY
50	NDG2B050L	HDG2B050L	LDG2B050L	CDT2B050
60	NDG2B060L	HDG2B060L	LDG2B060L	CDT2B060
70	NDG2B070L	HDG2B070L	LDG2B070L	CDT2B070
80	NDG2B080L	HDG2B080L	LDG2B080L	CDT2B080
90	NDG2B090L	HDG2B090L	LDG2B090L	CDT2B090
100	NDG2B100L	HDG2B100L	LDG2B100L	CDT2B100
110	NDG2B110L	HDG2B110L	LDG2B110L	CDT2B110
125	NDG2B125L	HDG2B125L	LDG2B125L	CDT2B125
150	NDG2B150L	HDG2B150L	LDG2B150L	CDT2B150

DG 150A Frame 3-Pole with Thermal-Magnetic Trip Unit

Continuous Ampere Rating	N-Interrupting Class	H-Interrupting Class	L-Interrupting Class	Catalogue Number
	Catalogue Number	Catalogue Number	Catalogue Number	
	FRAME ONLY			
	NDG3F150	HDG3F150	LDG3F150	
COMPLETE FACTORY ASSEMBLED CIRCUIT BREAKER				TRIP UNIT ONLY
50	NDG3B050L	HDG3B050L	LDG3B050L	CDT3B050
60	NDG3B060L	HDG3B060L	LDG3B060L	CDT3B060
70	NDG3B070L	HDG3B070L	LDG3B070L	CDT3B070
80	NDG3B080L	HDG3B080L	LDG3B080L	CDT3B080
90	NDG3B090L	HDG3B090L	LDG3B090L	CDT3B090
100	NDG3B100L	HDG3B100L	LDG3B100L	CDT3B100
110	NDG3B110L	HDG3B110L	LDG3B110L	CDT3B110
125	NDG3B125L	HDG3B125L	LDG3B125L	CDT3B125
150	NDG3B150L	HDG3B150L	LDG3B150L	CDT3B150

5

MOLDED CASE
CIRCUIT BREAKERS

VL Circuit Breakers

DG 150A Electronic 3-Knob & LCD Trip Units

Selection

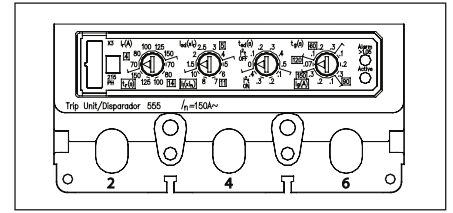
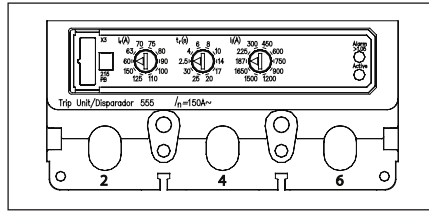

Model 555 Trip Units

DG 150A Frame 3-Pole Electronic Trip Unit^①

Continuous Ampere Rating	N-Interrupting Class	H-Interrupting Class	L-Interrupting Class	Catalogue Number
	Catalogue Number	Catalogue Number	Catalogue Number	
	FRAME ONLY			
	NDG3F150	HDG3F150	LDG3F150	
COMPLETE FACTORY ASSEMBLED CIRCUIT BREAKER				TRIP UNIT ONLY
ELECTRONIC LI TRIP				
60	NDG3R060L	HDG3R060L	LDG3R060L	CDT3R060
100	NDG3R100L	HDG3R100L	LDG3R100L	CDT3R100
150	NDG3R150L	HDG3R150L	LDG3R150L	CDT3R150
ELECTRONIC LSI TRIP				
60	NDG3T060L	HDG3T060L	LDG3T060L	CDT3T060
100	NDG3T100L	HDG3T100L	LDG3T100L	CDT3T100
150	NDG3T150L	HDG3T150L	LDG3T150L	CDT3T150
ELECTRONIC LSIG TRIP				
60	NDG3V060L	HDG3V060L	LDG3V060L	CDT3V060
100	NDG3V100L	HDG3V100L	LDG3V100L	CDT3V100
150	NDG3V150L	HDG3V150L	LDG3V150L	CDT3V150
ELECTRONIC LIG TRIP				
60	NDG3W060L	HDG3W060L	LDG3W060L	CDT3W060
100	NDG3W100L	HDG3W100L	LDG3W100L	CDT3W100
150	NDG3W150L	HDG3W150L	LDG3W150L	CDT3W150

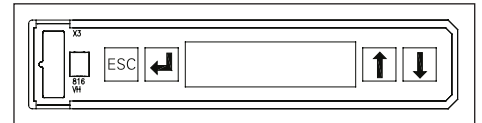

Model 586 Trip Unit

DG 150A Frame 3-Pole Electronic LCD Trip Unit^①

Continuous Ampere Rating	N-Interrupting Class	H-Interrupting Class	L-Interrupting Class	Catalogue Number
	Catalogue Number	Catalogue Number	Catalogue Number	
	FRAME ONLY			
	NDG3F150	HDG3F150	LDG3F150	
COMPLETE FACTORY ASSEMBLED CIRCUIT BREAKER				TRIP UNIT ONLY
LCD ELECTRONIC LSI TRIP				
60	NDG3A060L	HDG3A060L	LDG3A060L	CDT3A060
100	NDG3A100L	HDG3A100L	LDG3A100L	CDT3A100
150	NDG3A150L	HDG3A150L	LDG3A150L	CDT3A150
LCD ELECTRONIC LSIG TRIP				
100	NDG3G060L	HDG3G060L	LDG3G060L	CDT3G060
150	NDG3G100L	HDG3G100L	LDG3G100L	CDT3G100
250	NDG3G150L	HDG3G150L	LDG3G150L	CDT3G150
LCD ELECTRONIC LSI TRIP + GF ALARM ONLY				
100	NDG3K060L	HDG3K060L	LDG3K060L	CDT3K060
150	NDG3K100L	HDG3K100L	LDG3K100L	CDT3K100
250	NDG3K150L	HDG3K150L	LDG3K150L	CDT3K150

① Due to the location of the magnetic tripping solenoid, the left accessory pocket is not available for accessories.

VL Circuit Breakers

Internal Accessories for DG 150A and FG 250A Frames

Selection

Auxiliary Switch and Alarm Switch Combination Kits

Description	Mounting Pocket ^①	Catalogue Number
1 Alarm Switch 1A/B ^② Bases AMBL2 & AMBL3	Left, Right ^②	ASKL1
2 Aux. Switches 1A + 1B Bases AMBL1	Left, Right	ASKL2
2 Aux. + 1 Alarm Switches 1A + 1B, 1A/B ^② Bases AMBL2 & AMBL3	Left, Right ^②	ASKL3

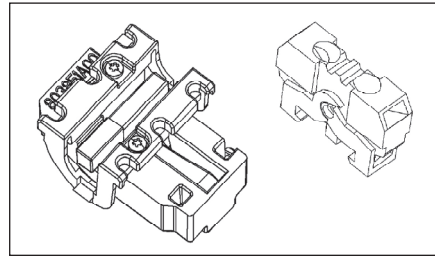

Auxiliary/Alarm Switch Mounting Base Only

Description	Mounting Pocket	Catalogue Number
Up to 3 Auxiliary Switches	Left, Right	AMBL1
2 Aux. + 1 Alarm Switch	Left Pocket Only	AMBL2
2 Aux. + 1 Alarm Switch	Right Pocket Only	AMBL3

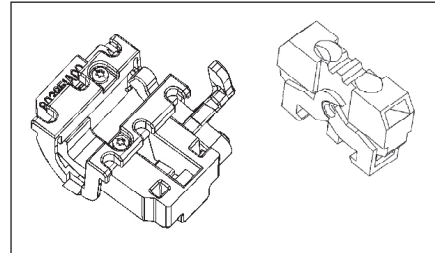

Auxiliary/Alarm Switch Only

Common to DG - PG Frames

Description	Catalogue Number
1 Normally Open Contact (1A)	ASWPA
1 Normally Closed Contact (1B)	ASWPB

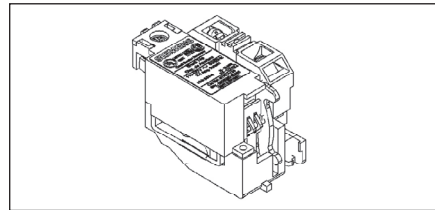

Shunt Trips

Description	Mounting Pocket	Catalogue Number
24 VDC	Right Pocket Only	STRLB24DC
48-60 VDC		STRLC60DC
110-127 VDC		STRLD125DC
220-250 VDC		STRLE250DC
48-60 VAC		STRLM60
110-127 VAC		STRLN120
208-277 VAC		STRLS277
380-600 VAC		STRLV600

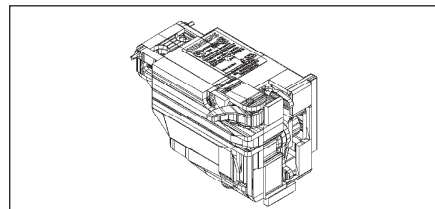

Undervoltage Release

Description	Mounting Pocket	Catalogue Number
12 VDC	Right Pocket Only	UVRLA12DC
24 VDC		UVRLB24DC
48 VDC		UVRLC48DC
60 VDC		UVRLG60DC
110-127 VDC		UVRLD125DC
220-250 VDC		UVRLE250DC
24 VAC		UVRLA24
110-127 VAC		UVRLN120
220-240 VAC		UVRLR240
208 VAC		UVRLP208
277 VAC		UVRLS277
380-415 VAC		UVRLT415
440-480 VAC		UVRLU480

'A' refers to a normally open contact (open when the breaker contacts are open).

'B' refers to a normally closed contact (closed when the breaker contacts are open).

① Refer to the "Accessory Locations" chart for guidelines and limitations about which pockets may be used for accessory combinations.

② These kits include two bases, one for mounting switches in the left pocket and another for mounting in the right.

③ Includes 1A and 1B contact for alarm purposes, only one of which may be installed at any time.

External Accessories page 5-195 - 5-209

VL Circuit Breakers

FG 250A Frame, VL Series

Selection/Dimensions

Ordering Information

Complete Assembled Breaker

A complete factory assembled FG breaker includes the frame, trip unit, and standard line and load connectors, all factory installed and shipped as a complete breaker. Assembled breakers are available only with standard connectors.

For any other configuration, order the frame, trip unit, and terminals as separate items.

For DC applications, use thermal magnetic trip unit only.

For reverse feed applications, select non-interchangeable trip breakers only. For non-interchangeable trip breakers, change the third digit of the catalogue number to "X" for standard breakers.

For special applications, refer to page 5-216.

Mounting hardware is included with each frame or complete breaker.
HACR rated.



Dimensions - Inches (mm)

Number of Poles	W	L	D	To Handle D1
2, 3	4.1 (105)	6.9 (175)	3.4 (81)	4.2 (107)

Interrupting Ratings

Interrupting Class	Breaker Type	RMS Symmetrical Amperes (KA)										
		CSA C22.2 NO.5 / UL 489					IEC 60947-2					
		Volts AC (50/60 Hz)			Volts DC		Volts AC (50/60 Hz)					
		240	480	600	250	500	220/240		380/415		690	
N	NFGA	65	35	18	30	18	I _{co}	I _{cs}	I _{co}	I _{cs}	I _{co}	I _{cs}
H	HFGA	100	65	20	30	25	100	75	70	70	12	6
L	LFGA	200	100	25	30	30	200	150	100	75	12	6

Shipping Weight, lbs. (kg)

Poles	Frame	Trip Unit		Complete Breaker
		Thermal-Mag.	Electronic	
2, 3	4.0 (1.8)	2.2 (1.0)	2.6 (1.2)	6.2 (2.8)

Connectors for 75°C Wire

Construction	Ampere Rating	Wire Range	No. of cables per phase	Catalogue Number
Steel	50-250	#4-350 kcmil Cu	1	3TW1FG350 [ⓐ]
Aluminum	50-250	#4-350 kcmil Al/Cu	1	3TAW1FG350 ^{ⓐⓑ}
Copper	50-250	#4-350 kcmil Cu	1	3TCW1FG350 [ⓐ]
Distribution Lugs				
	50-250	#14-2/0 Cu	3	3TA3FG20 [ⓐ]
	50-250	#14-#4 Cu	6	3TA6FG04 [ⓐ]
Compression Lugs				
	50-250	#4-350 Al/Cu	1	3CLF350 [ⓐ]

[ⓐ] Standard connector supplied with complete breakers.

[ⓑ] Kit consists of 3 terminal connectors.

FG Thermal-Magnetic, Instantaneous Trip Adjustment Range

Trip Unit Continuous Amp Rating (I _n)	Instantaneous Overcurrent Setting (I _i)	
	Min.	Max.
100	625	1250
110	800	1600
125	800	1600
150	800	1600
175	1000	2000
200	1000	2000
225	1250	2500
250	1250	2500

Note: Each breaker has 6 trip settings in this range.

External Accessories page 5-195 - 5-209

VL Circuit Breakers

FG 250A Thermal-Magnetic Trip Unit

Selection

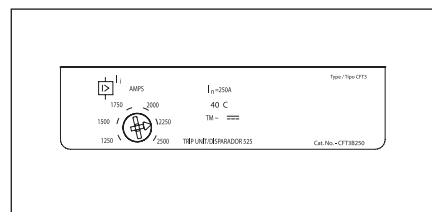

Model 525 Trip Unit

FG 250A Frame 2-Pole with Thermal-Magnetic Trip Unit

Continuous Ampere Rating	N-Interrupting Class	H-Interrupting Class	L-Interrupting Class	Catalogue Number
	Catalogue Number	Catalogue Number	Catalogue Number	
	FRAME ONLY			
	NFG2F250	HFG2F250	LFG2F250	
COMPLETE FACTORY ASSEMBLED CIRCUIT BREAKER				TRIP UNIT ONLY
100	NFG2B100L	HFG2B100L	LFG2B100L	CFT2B100
110	NFG2B110L	HFG2B110L	LFG2B110L	CFT2B110
125	NFG2B125L	HFG2B125L	LFG2B125L	CFT2B125
150	NFG2B150L	HFG2B150L	LFG2B150L	CFT2B150
175	NFG2B175L	HFG2B175L	LFG2B175L	CFT2B175
200	NFG2B200L	HFG2B200L	LFG2B200L	CFT2B200
225	NFG2B225L	HFG2B225L	LFG2B225L	CFT2B225
250	NFG2B250L	HFG2B250L	LFG2B250L	CFT2B250

FG 250A Frame 3-Pole with Thermal-Magnetic Trip Unit

Continuous Ampere Rating	N-Interrupting Class	H-Interrupting Class	L-Interrupting Class	Catalogue Number
	Catalogue Number	Catalogue Number	Catalogue Number	
	FRAME ONLY			
	NFG3F250	HFG3F250	LFG3F250	
COMPLETE FACTORY ASSEMBLED CIRCUIT BREAKER				TRIP UNIT ONLY
100	NFG3B100L	HFG3B100L	LFG3B100L	CFT3B100
110	NFG3B110L	HFG3B110L	LFG3B110L	CFT3B110
125	NFG3B125L	HFG3B125L	LFG3B125L	CFT3B125
150	NFG3B150L	HFG3B150L	LFG3B150L	CFT3B150
175	NFG3B175L	HFG3B175L	LFG3B175L	CFT3B175
200	NFG3B200L	HFG3B200L	LFG3B200L	CFT3B200
225	NFG3B225L	HFG3B225L	LFG3B225L	CFT3B225
250	NFG3B250L	HFG3B250L	LFG3B250L	CFT3B250

5

MOLDED CASE
CIRCUIT BREAKERS

VL Circuit Breakers

FG 250A Electronic 3-Knob & LCD Trip Units

Selection

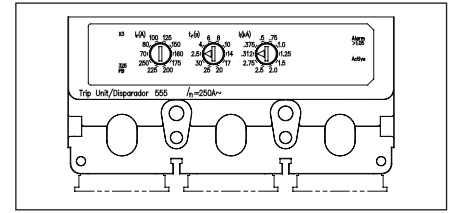
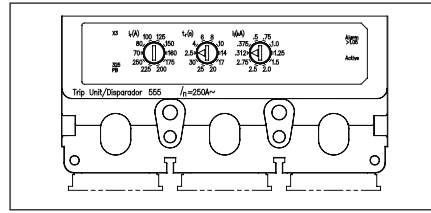

Model 555 Trip Units

FG 250A Frame 3-Pole Electronic Trip Unit^①

Continuous Ampere Rating	N-Interrupting Class	H-Interrupting Class	L-Interrupting Class	Catalogue Number
	Catalogue Number	Catalogue Number	Catalogue Number	
	FRAME ONLY			
	NFG3F250	HFG3F250	LFG3F250	
COMPLETE FACTORY ASSEMBLED CIRCUIT BREAKER				TRIP UNIT ONLY
ELECTRONIC LI TRIP				
100	NFG3R100L	HFG3R100L	LFG3R100L	CFT3R100
150	NFG3R150L	HFG3R150L	LFG3R150L	CFT3R150
250	NFG3R250L	HFG3R250L	LFG3R250L	CFT3R250
ELECTRONIC LSI TRIP				
100	NFG3T100L	HFG3T100L	LFG3T100L	CFT3T100
150	NFG3T150L	HFG3T150L	LFG3T150L	CFT3T150
250	NFG3T250L	HFG3T250L	LFG3T250L	CFT3T250
ELECTRONIC LSIG TRIP				
100	NFG3V100L	HFG3V100L	LFG3V100L	CFT3V100
150	NFG3V150L	HFG3V150L	LFG3V150L	CFT3V150
250	NFG3V250L	HFG3V250L	LFG3V250L	CFT3V250
ELECTRONIC LIG TRIP				
100	NFG3W100L	HFG3W100L	LFG3W100L	CFT3W100
150	NFG3W150L	HFG3W150L	LFG3W150L	CFT3W150
250	NFG3W250L	HFG3W250L	LFG3W250L	CFT3W250

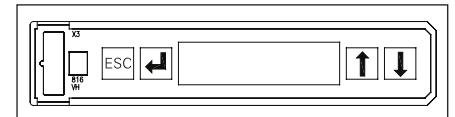

Model 586 Trip Unit

FG 250A Frame 3-Pole Electronic LCD Trip Unit^①

Continuous Ampere Rating	N-Interrupting Class	H-Interrupting Class	L-Interrupting Class	Catalogue Number
	Catalogue Number	Catalogue Number	Catalogue Number	
	FRAME ONLY			
	NFG3F250	HFG3F250	LFG3F250	
COMPLETE FACTORY ASSEMBLED CIRCUIT BREAKER				TRIP UNIT ONLY
LCD ELECTRONIC LSI TRIP				
100	NFG3A100L	HFG3A100L	LFG3A100L	CFT3A100
150	NFG3A150L	HFG3A150L	LFG3A150L	CFT3A150
250	NFG3A250L	HFG3A250L	LFG3A250L	CFT3A250
LCD ELECTRONIC LSIG TRIP				
100	NFG3G100L	HFG3G100L	LFG3G100L	CFT3G100
150	NFG3G150L	HFG3G150L	LFG3G150L	CFT3G150
250	NFG3G250L	HFG3G250L	LFG3G250L	CFT3G250
LCD ELECTRONIC LSI TRIP + GF ALARM ONLY				
100	NFG3K100L	HFG3K100L	LFG3K100L	CFT3K100
150	NFG3K150L	HFG3K150L	LFG3K150L	CFT3K150
250	NFG3K250L	HFG3K250L	LFG3K250L	CFT3K250

^① Due to the location of the magnetic tripping solenoid, the left accessory pocket is not available for accessories.

VL Circuit Breakers

Internal Accessories for DG 150A and FG 250A Frames

Selection

Auxiliary Switch and Alarm Switch Combination Kits

Description	Mounting Pocket ^①	Catalogue Number
1 Alarm Switch 1A/B ^② Bases AMBL2 & AMBL3	Left, Right ^②	ASKL1
2 Aux. Switches 1A + 1B Bases AMBL1	Left, Right	ASKL2
2 Aux. + 1 Alarm Switches 1A + 1B, 1A/B ^② Bases AMBL2 & AMBL3	Left, Right ^②	ASKL3

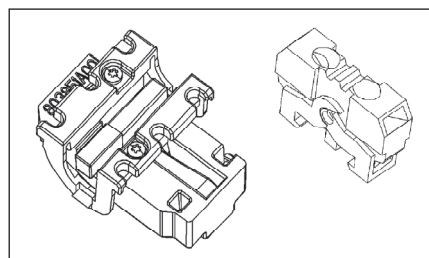

Auxiliary/Alarm Switch Mounting Base Only

Description	Mounting Pocket	Catalogue Number
Up to 3 Auxiliary Switches	Left, Right	AMBL1
2 Aux. + 1 Alarm Switch	Left Pocket Only	AMBL2
2 Aux. + 1 Alarm Switch	Right Pocket Only	AMBL3

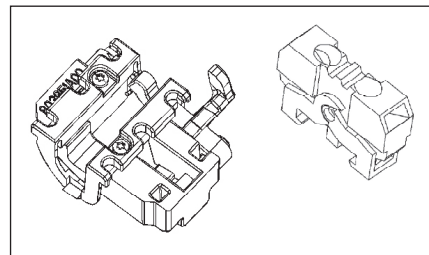

Auxiliary/Alarm Switch Only

Common to DG - PG Frames

Description	Catalogue Number
1 Normally Open Contact (1A)	ASWPA
1 Normally Closed Contact (1B)	ASWPB

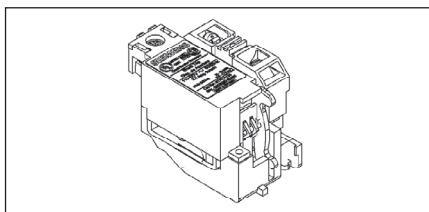

Shunt Trips

Description	Mounting Pocket	Catalogue Number
24 VDC	Right Pocket Only	STRLB24DC
48-60 VDC		STRLC60DC
110-127 VDC		STRLD125DC
220-250 VDC		STRLE250DC
48-60 VAC		STRLM60
110-127 VAC		STRLN120
208-277 VAC		STRLS277
380-600 VAC		STRLV600

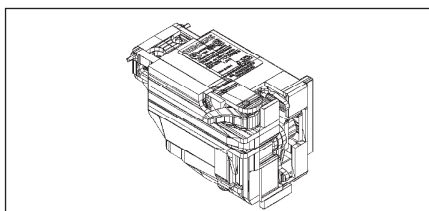

Undervoltage Release

Description	Mounting Pocket	Catalogue Number
12 VDC	Right Pocket Only	UVRLA12DC
24 VDC		UVRLB24DC
48 VDC		UVRLC48DC
60 VDC		UVRLG60DC
110-127 VDC		UVRLD125DC
220-250 VDC		UVRLE250DC
24 VAC		UVRLI24
110-127 VAC		UVRLN120
220-240 VAC		UVRLR240
208 VAC		UVRLP208
277 VAC		UVRLS277
380-415 VAC		UVRLT415
440-480 VAC		UVRLU480

① Refer to the "Accessory Locations" chart for guidelines and limitations about which pockets may be used for accessory combinations.

② These kits include two bases, one for mounting switches in the left pocket and another for mounting in the right.

③ Includes 1A and 1B contact for alarm purposes, only one of which may be installed at any time.

'A' refers to a normally open contact (open when the breaker contacts are open).

'B' refers to a normally closed contact (closed when the breaker contacts are open).

External Accessories page 5-195 - 5-209

VL Circuit Breakers

JG 400A Frame, VL Series

Selection/Dimensions

Ordering Information

Complete Assembled Breaker

A complete factory assembled JG breaker includes the frame, trip unit, and standard line and load connectors, all factory installed and shipped as a complete breaker. Assembled breakers are available only with standard connectors.

For any other configuration, order the frame, trip unit, and terminals as separate items.

For DC applications, use thermal magnetic trip unit only.

For reverse feed applications, select non-interchangeable trip breakers only.

For non-interchangeable trip breakers, change the third digit of the catalogue number to "X" for standard breakers.

For 100% rated breakers with a non-interchangeable trip unit, change the 3rd character of the catalogue number to "Y".

For special applications, refer to page 5-216.

Mounting hardware is included with each frame or complete breaker.

HACR rated.



Dimensions - Inches (mm)

Number of Poles	W	L	D	To Handle D1
2, 3	5.5 (139)	11 (279)	4.2 (102)	5.4 (138)

Shipping Weight, lbs. (kg)

Poles	Frame	Trip Unit		Complete Breaker
		Thermal-Mag.	Electronic	
2, 3	9.3 (7.9)	4.0 (1.8)	4.0 (1.8)	12.6 (5.7)

Interrupting Ratings

Interrupting Class	Breaker Type	RMS Symmetrical Amperes (KA)										
		UL 489 AIR (File E10848)					IEC 60947-2					
		Volts AC (50/60 Hz)			Volts DC		Volts AC (50/60 Hz)					
		240	480	600	250	500	220/240		380/415		690	
N	NJGA	65	35	25	30	25	65	65	45	45	12	6
H	HJGA	100	65	25	30	35	100	75	70	70	15	8
L	LJGA	200	100	25	30	35	200	150	100	75	15	8

Connectors for 75°C Wire

Construction	Ampere Rating	Wire Range	No. of cables per phase	Catalogue Number
Steel	70-400	1/0-600 kcmil Cu	1	3TW1JG600 ^②
Aluminum	70-400	3/0-250 kcmil Al/Cu	2	3TA2JG250 ^{①②}
Aluminum	70-400	250-750 kcmil Al	1	3TA1JG750 ^②
Aluminum	70-400	3/0-600 kcmil Cu	1	3TA1JG750 ^②
Copper	70-400	3/0-750 kcmil Cu	1	TC1JG750 ^③
Copper	70-400	3/0-250 kcmil Cu	2	TC2JG250 ^③
Distribution Lugs				
	70-400	#14-4 Cu	12	3TA12JG04 ^②
	70-400	#14-2/0 Cu	6	3TA6JG20 ^②
Compression Lugs				
	70-400	#6-350 kcmil	—	3CLJ350 ^②
	70-400	250-600 kcmil	—	3CLJ600 ^②
	70-400	250-750 kcmil	—	3CLJ750 ^②

① Standard construction supplied for each breaker.

② Kit consists of 3 terminal connectors.

③ Required for 100% rated JG breakers. Requires 90°C cable sized at 75°C ampacity.

JG Thermal-Magnetic, Instantaneous Trip Adjustment Range

Trip Unit Continuous Amp Rating (I _n)	Instantaneous Overcurrent Setting (I _i)	
	Min.	Max.
250	1250	2500
300	1500	3000
350	1750	3500
400	2000	4000

Note: Each breaker has 6 trip settings in this range.

External Accessories page 5-195 - 5-209

VL Circuit Breakers

JG 400A Thermal-Magnetic Trip Unit

Selection

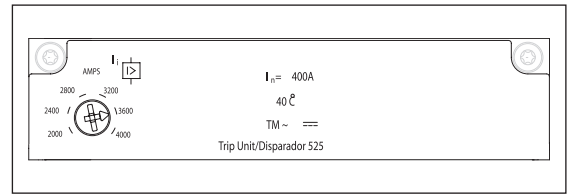

Model 525 Trip Unit

JG 400A Frame 2-Pole with Thermal-Magnetic Trip Unit

Continuous Ampere Rating	N-Interrupting Class	H-Interrupting Class	L-Interrupting Class	Catalogue Number
	Catalogue Number	Catalogue Number	Catalogue Number	
	FRAME ONLY			
	NJG2F400	HJG2F400	LJG2F400	
COMPLETE FACTORY ASSEMBLED CIRCUIT BREAKER				TRIP UNIT ONLY
250	NJG2B250L	HJG2B250L	LJG2B250L	CJT2B250
300	NJG2B300L	HJG2B300L	LJG2B300L	CJT2B300
350	NJG2B350L	HJG2B350L	LJG2B350L	CJT2B350
400	NJG2B400L	HJG2B400L	LJG2B400L	CJT2B400

JG 400A Frame 3-Pole with Thermal-Magnetic Trip Unit

Continuous Ampere Rating	N-Interrupting Class	H-Interrupting Class	L-Interrupting Class	Catalogue Number
	Catalogue Number	Catalogue Number	Catalogue Number	
	FRAME ONLY			
	NJG3F400	HJG3F400	LJG3F400	
COMPLETE FACTORY ASSEMBLED CIRCUIT BREAKER				TRIP UNIT ONLY
250	NJG3B250L	HJG3B250L	LJG3B250L	CJT3B250
300	NJG3B300L	HJG3B300L	LJG3B300L	CJT3B300
350	NJG3B350L	HJG3B350L	LJG3B350L	CJT3B350
400	NJG3B400L	HJG3B400L	LJG3B400L	CJT3B400

5
MOLDED CASE
CIRCUIT BREAKERS

JJ 400A Frame 240V max., 2-pole with Thermal-Magnetic Non-Interchangeable Trip Unit^①

Continuous Ampere Rating	N-Interrupting Class
	Catalogue Number
	COMPLETE BREAKER
250	NJJ2B250
300	NJJ2B300
350	NJJ2B350
400	NJJ2B400

JJ 400A Frame 240V max., 3-pole with Thermal-Magnetic Non-Interchangeable Trip Unit^①

Continuous Ampere Rating	N-Interrupting Class
	Catalogue Number
	COMPLETE BREAKER
250	NJJ3B250
300	NJJ3B300
350	NJJ3B350
400	NJJ3B400

^① Terminal connectors must be ordered separately.
Breaker Type NJJA.

VL Circuit Breakers

JG 400A Electronic 3-Knob & LCD Trip Units

Selection

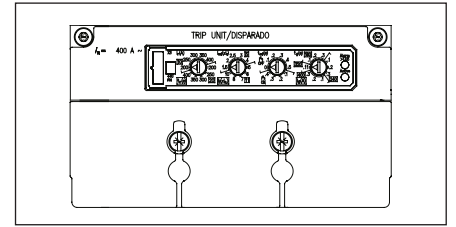
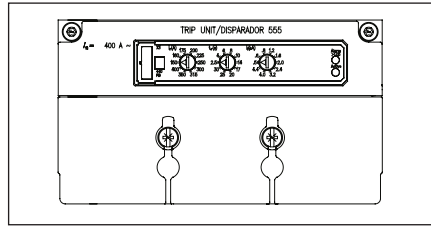

Model 555 Trip Units

JG 400A Frame 3-Pole Electronic Trip Unit

Continuous Ampere Rating	N-Interrupting Class	H-Interrupting Class	L-Interrupting Class	Catalogue Number
	Catalogue Number	Catalogue Number	Catalogue Number	
	FRAME ONLY			
	COMPLETE FACTORY ASSEMBLED CIRCUIT BREAKER			
	NJG3F400	HJG3F400	LJG3F400	TRIP UNIT ONLY
ELECTRONIC LI TRIP				
250 400	NJG3R250L NJG3R400L	HJG3R250L HJG3R400L	LJG3R250L LJG3R400L	CJT3R250 CJT3R400
ELECTRONIC LSI TRIP				
250 400	NJG3T250L NJG3T400L	HJG3T250L HJG3T400L	LJG3T250L LJG3T400L	CJT3T250 CJT3T400
ELECTRONIC LSIG TRIP				
250 400	NJG3V250L NJG3V400L	HJG3V250L HJG3V400L	LJG3V250L LJG3V400L	CJT3V250 CJT3V400
ELECTRONIC LIG TRIP				
250 400	NJG3W250L NJG3W400L	HJG3W250L HJG3W400L	LJG3W250L LJG3W400L	CJT3W250 CJT3W400

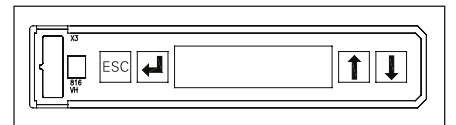

Model 586 Trip Unit

JG 400A Frame 3-Pole Electronic LCD Trip Unit

Continuous Ampere Rating	N-Interrupting Class	H-Interrupting Class	L-Interrupting Class	Catalogue Number
	Catalogue Number	Catalogue Number	Catalogue Number	
	FRAME ONLY			
	COMPLETE FACTORY ASSEMBLED CIRCUIT BREAKER			
	NJG3F400	HJG3F400	LJG3F400	TRIP UNIT ONLY
LCD ELECTRONIC LSI TRIP				
250 400	NJG3A250L NJG3A400L	HJG3A250L HJG3A400L	LJG3A250L LJG3A400L	CJT3A250 CJT3A400
LCD ELECTRONIC LSIG TRIP				
250 400	NJG3G250L NJG3G400L	HJG3G250L HJG3G400L	LJG3G250L LJG3G400L	CJT3G250 CJT3G400
LCD ELECTRONIC LSI TRIP + GF ALARM ONLY				
250 400	NJG3K250L NJG3K400L	HJG3K250L HJG3K400L	LJG3K250L LJG3K400L	CJT3K250 CJT3K400

VL Circuit Breakers

Internal Accessories for JG 400A and LG 600A Frames

Selection

Auxiliary Switch and Alarm Switch Combination Kits

Description	Mounting Pocket ^①	Catalogue Number
1 Alarm Switch 1A/B ^② Bases AMBL2 & AMBL3	Left, Right ^②	ASKL1
2 Aux. Switches 1A + 1B Bases AMBL1	Left, Right	ASKL2
2 Aux. + 1 Alarm Switches 1A + 1B, 1A/B ^② Bases AMBL2 & AMBL3	Left, Right ^②	ASKL3

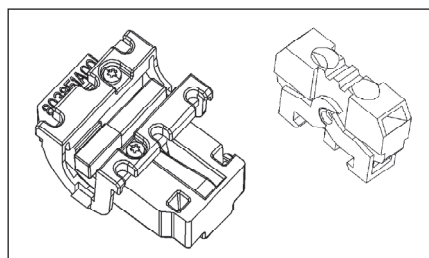

Auxiliary/Alarm Switch Mounting Base Only

Description	Mounting Pocket	Catalogue Number
Up to 3 Auxiliary Switches	Left, Right	AMBL1
2 Aux. + 1 Alarm Switch	Left Pocket Only	AMBL2
2 Aux. + 1 Alarm Switch	Right Pocket Only	AMBL3

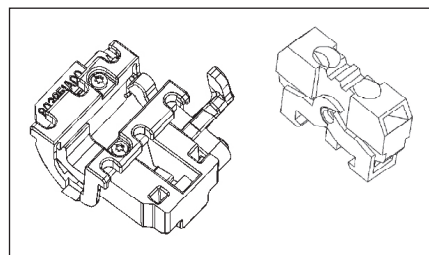

Auxiliary/Alarm Switch Only

Common to DG - PG Frames

Description	Catalogue Number
1 Normally Open Contact (1A)	ASWPA
1 Normally Closed Contact (1B)	ASWPB

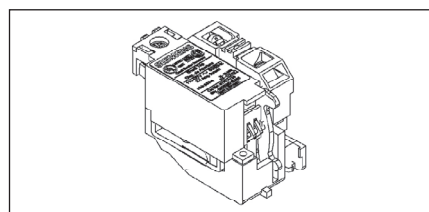

Shunt Trips

Description	Mounting Pocket	Catalogue Number
24 VDC	Right Pocket Only	STRLB24DC
48-60 VDC		STRLC60DC
110-127 VDC		STRLD125DC
220-250 VDC		STRLE250DC
48-60 VAC		STRLM60
110-127 VAC		STRLN120
208-277 VAC		STRLS277
380-600 VAC		STRLV600

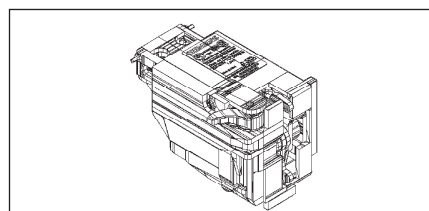

Undervoltage Release

Description	Mounting Pocket	Catalogue Number
12 VDC	Right Pocket Only	UVRLA12DC
24 VDC		UVRLB24DC
48 VDC		UVRLC48DC
60 VDC		UVRLG60DC
110-127 VDC		UVRLD125DC
220-250 VDC		UVRLE250DC
24 VAC		UVRLI24
110-127 VAC		UVRLN120
220-240 VAC		UVRLR240
208 VAC		UVRLP208
277 VAC		UVRLS277
380-415 VAC		UVRLT415
440-480 VAC		UVRLU480

① Refer to the "Accessory Locations" chart for guidelines and limitations about which pockets may be used for accessory combinations.

② Includes 1A and 1B contact for alarm purposes, only one of which may be installed at any time.

'A' refers to a normally open contact (open when the breaker contacts are open).

'B' refers to a normally closed contact (closed when the breaker contacts are open).

External Accessories page 5-195 - 5-209

VL Circuit Breakers

LG 600A Frame, VL Series

Selection/Dimensions

Ordering Information

Complete Assembled Breaker

A complete factory assembled LG breaker includes the frame, trip unit, and standard line and load lugs, all factory installed and shipped as a complete breaker. Assembled breakers are available only with standard connectors.

For DC applications, use thermal magnetic trip unit only.

Breakers are suitable for reverse feed applications.

For special applications, refer to page 5-216.

Mounting hardware is included with each breaker.

For 100% rated breakers, change the 3rd character of the catalogue number to "W". Available on 400/500 Amp only.

HACR rated.



Interrupting Ratings

Interrupting Class	Breaker Type	RMS Symmetrical Amperes (KA)										
		CSA C22.2 NO.5 / UL 489					IEC 60947-2					
		Volts AC (50/60 Hz)			Volts DC		Volts AC (50/60 Hz)					
		240	480	600	250	500	220/240		380/415		690	
					I _{cu}	I _{cs}	I _{cu}	I _{cs}	I _{cu}	I _{cs}		
N	NLGB	65	35	18	30	25	65	65	45	45	12	6
H	HLGB	100	65	18	30	35	100	75	70	70	15	8
L	LLGB	200	100	18	30	35	200	150	100	75	15	8

Dimensions - Inches (mm)

Number of Poles	W	L	D	To Handle D1
2, 3	5.5 (139)	11 (279)	4.2 (102)	5.4 (138)
Ext. Shield		13.6 (345.5)		

Shipping Weight, lbs. (kg)

Poles	Frame	Trip Unit		Complete Breaker
		Thermal-Mag.	Electronic	
2, 3	17.4 (7.9)	3.5 (1.6)	4.2 (1.9)	20.9 (9.5)

Connectors for 75°C Wire

Construction	Ampere Rating	Wire Range	No. of cables per phase	Catalogue Number ²
Aluminum	150-600	#2/0-600 kcmil Al/Cu	2 (load side)	3TA2LG600LD ¹
Aluminum	150-600	#2/0-600 kcmil Al/Cu	2 (line side)	3TA2LG600LN ¹
Copper	150-600	#2/0-600 kcmil Cu	2 (load side)	3TC2LG600LD ³
Copper	150-600	#2/0-600 kcmil Cu	2 (line side)	3TC2LG600LN ³
Compression Lugs				
	150-600	#6-350 kcmil Al/Cu	—	6CLL350 ³
	150-600	250-750 kcmil Al/Cu	—	3CLL750 ²
	150-600	250-600 kcmil Al/Cu	—	6CLL600 ³

¹ Standard construction supplied for each breaker.

² Kit consists of 3 terminal connectors.

³ Kit consists of 6 lugs for Line or Load end.

⁴ Required for 100% rated LG breakers. Requires 90°C cable sized at 75°C ampacity.

LG Thermal-Magnetic, Instantaneous Trip Adjustment Range

Trip Unit Continuous Amp Rating (I _n)	Instantaneous Overcurrent Setting (I _i)	
	Min.	Max.
400	2000	4000
500	2500	5000
600	2750	5500

Note: Each breaker has 6 trip settings.

External Accessories page 5-195 - 5-209

VL Circuit Breakers

LG 600A Electronic 3-Knob & LCD Trip Units

Selection

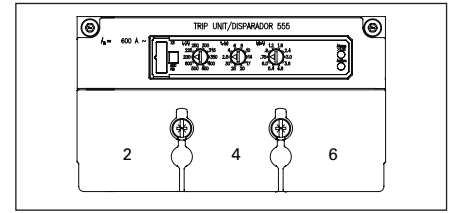

Model 555 Trip Unit

LG 600A Frame 3-Pole Electronic Trip Unit

Continuous Ampere Rating	N-Interrupting Class	H-Interrupting Class	L-Interrupting Class
	Catalogue Number	Catalogue Number	Catalogue Number
COMPLETE FACTORY ASSEMBLED CIRCUIT BREAKER			
ELECTRONIC LI TRIP			
400	NLK3R400L	HLK3R400L	LLK3R400L
600	NLK3R600L	HLK3R600L	LLK3R600L
ELECTRONIC LSI TRIP			
400	NLK3T400L	HLK3T400L	LLK3T400L
600	NLK3T600L	HLK3T600L	LLK3T600L
ELECTRONIC LSIG TRIP			
400	NLK3V400L	HLK3V400L	LLK3V400L
600	NLK3V600L	HLK3V600L	LLK3V600L
ELECTRONIC LIG TRIP			
400	NLK3W400L	HLK3W400L	LLK3W400L
600	NLK3W600L	HLK3W600L	LLK3W600L

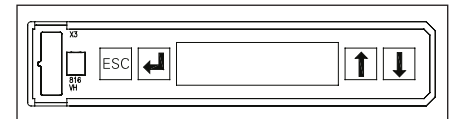

Model 586 Trip Unit

LG 600A Frame 3-Pole Electronic LCD Trip Unit

Continuous Ampere Rating	N-Interrupting Class	H-Interrupting Class	L-Interrupting Class
	Catalogue Number	Catalogue Number	Catalogue Number
COMPLETE FACTORY ASSEMBLED CIRCUIT BREAKER			
ELECTRONIC LSI TRIP			
400	NLK3A400L	HLK3A400L	LLK3A400L
600	NLK3A600L	HLK3A600L	LLK3A600L
ELECTRONIC LSIG TRIP			
400	NLK3G400L	HLK3G400L	LLK3G400L
600	NLK3G600L	HLK3G600L	LLK3G600L
ELECTRONIC LSIG TRIP + GFG ALARM ONLY			
400	NLK3K400L	HLK3K400L	LLK3K400L
600	NLK3K600L	HLK3K600L	LLK3K600L

VL Circuit Breakers

Internal Accessories for JG 400A and LG 600A Frames

Selection

Auxiliary Switch and Alarm Switch Combination Kits

Description	Mounting Pocket ^①	Catalogue Number
1 Alarm Switch 1A/B ^② Bases AMBL2 & AMBL3	Left, Right ^②	ASKL1
2 Aux. Switches 1A + 1B Bases AMBL1	Left, Right	ASKL2
2 Aux. + 1 Alarm Switches 1A + 1B, 1A/B ^② Bases AMBL2 & AMBL3	Left, Right ^②	ASKL3

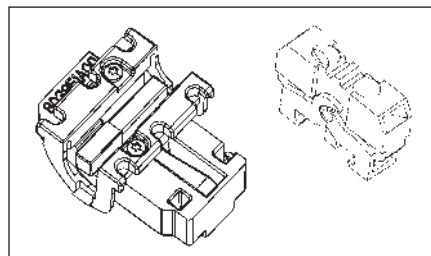

Auxiliary/Alarm Switch Mounting Base Only

Description	Mounting Pocket	Catalogue Number
Up to 3 Auxiliary Switches	Left, Right	AMBL1
2 Aux. + 1 Alarm Switch	Left Pocket Only	AMBL2
2 Aux. + 1 Alarm Switch	Right Pocket Only	AMBL3

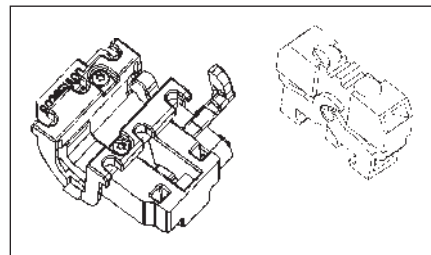

Auxiliary/Alarm Switch Only

Common to DG - PG Frames

Description	Catalogue Number
1 Normally Open Contact (1A)	ASWPA
1 Normally Closed Contact (1B)	ASWPB

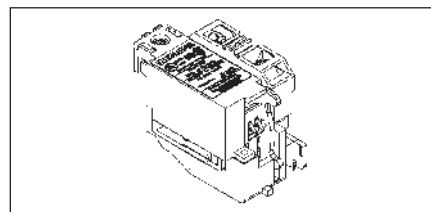

Shunt Trips

Description	Mounting Pocket	Catalogue Number
24 VDC	Right Pocket Only	STRLB24DC
48-60 VDC		STRLC60DC
110-127 VDC		STRLD125DC
220-250 VDC		STRLE250DC
48-60 VAC		STRLM60
110-127 VAC		STRLN120
208-277 VAC		STRLS277
380-600 VAC		STRLV600

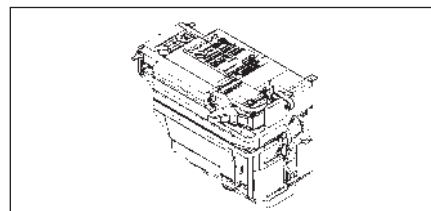

Undervoltage Release

Description	Mounting Pocket	Catalogue Number
12 VDC	Right Pocket Only	UVRLA12DC
24 VDC		UVRLB24DC
48 VDC		UVRLC48DC
60 VDC		UVRLG60DC
110-127 VDC		UVRLD125DC
220-250 VDC		UVRLE250DC
24 VAC		UVRL24
110-127 VAC		UVRLN120
220-240 VAC		UVRLR240
208 VAC		UVRLP208
277 VAC		UVRLS277
380-415 VAC		UVRLT415
440-480 VAC		UVRLU480

① Refer to the "Accessory Locations" chart for guidelines and limitations about which pockets may be used for accessory combinations.

② Includes 1A and 1B contact for alarm purposes, only one of which may be installed at any time.

'A' refers to a normally open contact (open when the breaker contacts are open).

'B' refers to a normally closed contact (closed when the breaker contacts are open).

External Accessories page 5-195 - 5-209

VL Circuit Breakers

MG 800A Frame, VL Series

Selection/Dimensions

Ordering Information

Complete Assembled Breaker

A complete factory assembled MG breaker includes the frame, trip unit, and standard line and load lugs, all factory installed and shipped as a complete breaker. Assembled breakers are available only with standard connectors.

For any other configuration, order the frame, trip unit, and terminals as separate items.

For DC applications, use thermal magnetic trip unit only.

For reverse feed applications, select non-interchangeable trip breakers only. For non-interchangeable trip breakers, change the third digit of the catalogue number to "X" for standard breakers.

For 100% rated breakers with a non-interchangeable trip unit, change the 3rd character of the catalogue number to "Y".

For special applications, refer to page 5-216.

Mounting hardware is included with each frame or complete breaker.

HACR rated.



Dimensions - Inches (mm)

Number of Poles	W	L	D	To Handle D1
2, 3	7.5 (190)	16 (406)	4.7 (119)	5.9 (151)

Shipping Weight, lbs. (kg)

Poles	Frame	Trip Unit	Complete Breaker
2, 3	31.3 (14.2)	4.0 (1.8)	35.3 (16.0)

Interrupting Ratings

Interrupting Class	Breaker Type	RMS Symmetrical Amperes (KA)										
		CSA C22.2 NO.5 / UL 489					IEC 60947-2					
		Volts AC (50/60 Hz)			Volts DC		Volts AC (50/60 Hz)					
		240	480	600	250	500	220/240		380/415		690	
N	NMG	65	35	25	22	35	65	65	50	50	20	10
H	HMG	100	65	35	25	50	100	75	70	70	30	15
L	LMG	200	100	50	42	65	200	150	100	75	35	17

Connectors for 75°C Wire

Construction	Ampere Rating	Wire Range	No. of cables per phase	Catalogue Number
Aluminum	200-800A	1/0-500 kcmil Al/Cu	3	3TA3MG500 ^{①②}
Aluminum	200-800A	500-750 kcmil Al/Cu	2	3TA2MG750 ^②
Copper	200-800A	1/0-500 kcmil Cu	3	TC3MG500 ^{③④}
Aluminum	200-800A	#2-600 kcmil Al/Cu	3	3TA3MG600 ^{②④}

① Standard connector supplied with complete breakers.

② Kit consists of 3 terminal connectors.

③ Consists of one terminal.

④ Includes extended terminal cover.

⑤ Required for 100% rated MG breakers. Requires 90°C cable sized at 75°C ampacity.

MG Thermal-Magnetic, Instantaneous Trip Adjustment Range

Trip Unit Continuous Amp Rating (I _n)	Instantaneous Overcurrent Setting (I _i)	
	Min.	Max.
600	3000	6000
700	3250	6500
800	3250	6500

Note: Each breaker has 6 trip settings.

External Accessories page 5-195 - 5-209

VL Circuit Breakers

MG 800A Thermal-Magnetic Trip Unit

Selection

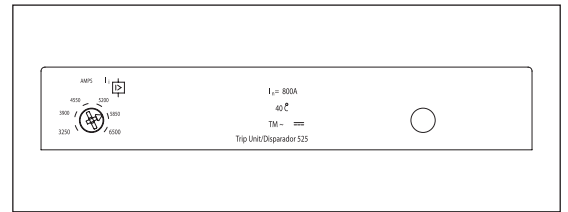

Model 525 Trip Unit

MG 800A Frame 2-Pole with Thermal-Magnetic Trip Unit

Continuous Ampere Rating	N-Interrupting Class	H-Interrupting Class	L-Interrupting Class	Catalogue Number
	Catalogue Number	Catalogue Number	Catalogue Number	
	FRAME ONLY			
	NMG2F800	HMG2F800	LMG2F800	
	COMPLETE FACTORY ASSEMBLED CIRCUIT BREAKER			TRIP UNIT ONLY
600	NMG2B600L	HMG2B600L	LMG2B600L	CMT2B600
700	NMG2B700L	HMG2B700L	LMG2B700L	CMT2B700
800	NMG2B800L	HMG2B800L	LMG2B800L	CMT2B800

MG 800A Frame 3-Pole with Thermal-Magnetic Trip Unit

Continuous Ampere Rating	N-Interrupting Class	H-Interrupting Class	L-Interrupting Class	Catalogue Number
	Catalogue Number	Catalogue Number	Catalogue Number	
	FRAME ONLY			
	NMG3F800	HMG3F800	LMG3F800	
	COMPLETE FACTORY ASSEMBLED CIRCUIT BREAKER			TRIP UNIT ONLY
600	NMG3B600L	HMG3B600L	LMG3B600L	CMT3B600
700	NMG3B700L	HMG3B700L	LMG3B700L	CMT3B700
800	NMG3B800L	HMG3B800L	LMG3B800L	CMT3B800

5

**MOLDED CASE
CIRCUIT BREAKERS**

VL Circuit Breakers

MG 800A Electronic 3-Knob & LCD Trip Units

Selection

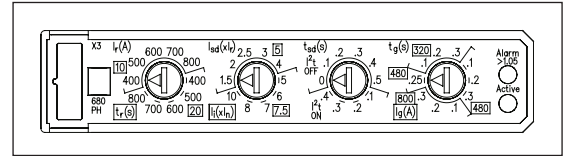
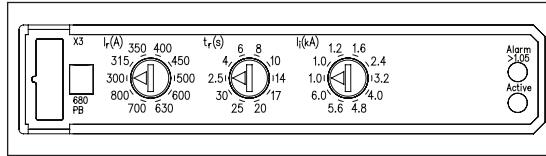

Model 555 Trip Units

MG 800A Frame 3-Pole Electronic Trip Unit

Continuous Ampere Rating	N-Interrupting Class	H-Interrupting Class	L-Interrupting Class	Catalogue Number
	Catalogue Number	Catalogue Number	Catalogue Number	
	FRAME ONLY			
	NMG3F800	HMG3F800	LMG3F800	
COMPLETE FACTORY ASSEMBLED CIRCUIT BREAKER				TRIP UNIT ONLY
ELECTRONIC LI TRIP				
600 800	NMG3R600L NMG3R800L	HMG3R600L HMG3R800L	LMG3R600L LMG3R800L	CMT3R600 CMT3R800
ELECTRONIC LSI TRIP				
600 800	NMG3T600L NMG3T800L	HMG3T600L HMG3T800L	LMG3T600L LMG3T800L	CMT3T600 CMT3T800
ELECTRONIC LSIG TRIP				
600 800	NMG3V600L NMG3V800L	HMG3V600L HMG3V800L	LMG3V600L LMG3V800L	CMT3V600 CMT3V800
ELECTRONIC LIG TRIP				
600 800	NMG3W600L NMG3W800L	HMG3W600L HMG3W800L	LMG3W600L LMG3W800L	CMT3W600 CMT3W800

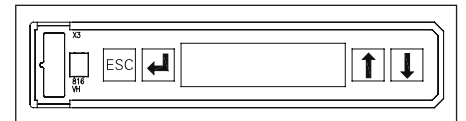

Model 586 Trip Unit

MG 800A Frame 3-Pole Electronic LCD Trip Unit

Continuous Ampere Rating	N-Interrupting Class	H-Interrupting Class	L-Interrupting Class	Catalogue Number
	Catalogue Number	Catalogue Number	Catalogue Number	
	FRAME ONLY			
	NMG3F800	HMG3F800	LMG3F800	
COMPLETE FACTORY ASSEMBLED CIRCUIT BREAKER				TRIP UNIT ONLY
LCD ELECTRONIC LSI TRIP				
600 800	NMG3A600L NMG3A800L	HMG3A600L HMG3A800L	LMG3A600L LMG3A800L	CMT3A600 CMT3A800
LCD ELECTRONIC LSIG TRIP				
600 800	NMG3G600L NMG3G800L	HMG3G600L HMG3G800L	LMG3G600L LMG3G800L	CMT3G600 CMT3G800
LCD ELECTRONIC LSIG TRIP + GF ALARM ONLY				
600 800	NMG3K600L NMG3K800L	HMG3K600L HMG3K800L	LMG3K600L LMG3K800L	CMT3K600 CMT3K800

VL Circuit Breakers

Internal Accessories for MG 800A, NG 1200A and PG 1600A Frames

Selection

Auxiliary Switch and Alarm Switch Combination Kits

Description	Mounting Pocket ^①	Catalogue Number
2 Aux. + 2 Alarm Switches 2A + 2B Base AMBP2	Left Pocket Only	ASKP3
4 Aux. Switches 2A + 2B Base AMBP1	Left, Right	ASKP4

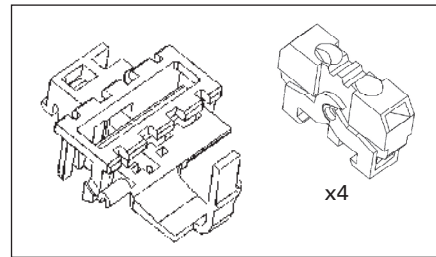

Auxiliary/Alarm Switch Mounting Base Only

Description	Mounting Pocket ^①	Catalogue Number
Up to 4 Auxiliary Switches	Left, Right	AMBP1
2 Aux. + 2 Alarm Switches	Left Pocket Only	AMBP2

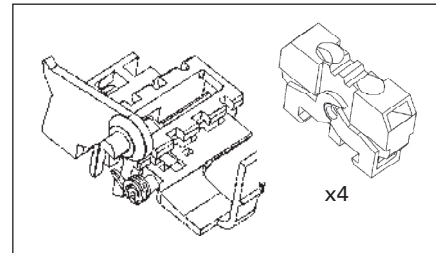

Auxiliary/Alarm Switch Only

Common to DG - PG Frames

Description	Catalogue Number
1 Normally Open Contact (1A)	ASWPA
1 Normally Closed Contact (1B)	ASWPB

Shunt Trips

Description	Mounting Pocket	Catalogue Number
24 VDC	Right Pocket Only	STRPB24DC
48-60 VDC		STRPC60DC
110-127 VDC		STRPD125DC
220-250 VDC		STRPE250DC
48-60 VAC		STRPM60
110-127 VAC		STRPN120
208-277 VAC		STRPS277
380-600 VAC		STRPV600

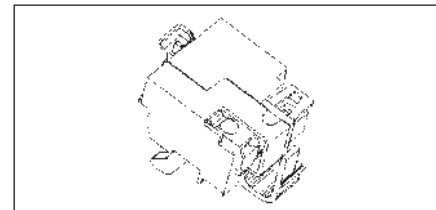

Undervoltage Release

Description	Mounting Pocket	Catalogue Number
12 VDC	Right Pocket Only	UVRPA12DC
24 VDC		UVRPB24DC
48 VDC		UVRPC48DC
60 VDC		UVRPG60DC
110-127 VDC		UVRPD125DC
220-250 VDC		UVRPE250DC
110-127 VAC		UVRPN120
220-240 VAC		UVRPR240
208 VAC		UVRPP208
277 VAC		UVRPS277
380-415 VAC		UVRPT415
440-480 VAC		UVRPU480

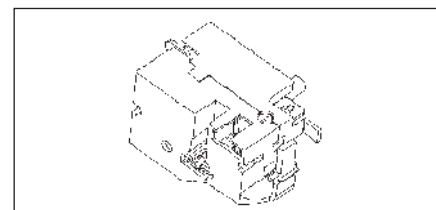

① Refer to the "Accessory Locations" chart for guidelines and limitations about which pockets may be used for accessory combinations.

'A' refers to a normally open contact (open when the breaker contacts are open).

'B' refers to a normally closed contact (closed when the breaker contacts are open).

VL Circuit Breakers

NG 1200A Frame, VL Series

Selection/Dimensions

Ordering Information

Complete Assembled Breaker with Lugs

A complete factory assembled NG breaker includes the frame, trip unit, and standard line and load lugs, all factory installed and shipped as a complete breaker. Assembled breakers are available only with standard connectors.

For any other configuration, order the frame, trip unit, and terminals as separate items.

For DC applications, use thermal magnetic trip unit only.

For reverse feed applications, select non-interchangeable trip breakers only. For non-interchangeable trip breakers, change the third digit of the catalogue number to "X" for standard breakers.

For 100% rated breakers with a non-interchangeable trip unit, change the 3rd character of the catalogue number to "Y".

For special applications, refer to page 5-216.

Mounting hardware is included with each frame or complete breaker.

A Toggle Handle Extension is included with each frame or complete breaker.

HACR rated.



Dimensions - Inches (mm)

Number of Poles	W	L	D	To Handle D1
2, 3	9 (229)	16 (406)	6 (152)	8.1 (207)

Shipping Weight, lbs. (kg)

Poles	Frame	Trip Unit	Complete Breaker
2, 3	46.3 (21.0)	8.8 (4.0)	55.1 (25.0)

Interrupting Ratings

Interrupting Class	Breaker Type	RMS Symmetrical Amperes (KA)										
		CSA C22.2 NO.5 / UL 489					IEC 60947-2					
		Volts AC (50/60 Hz)			Volts DC		Volts AC (50/60 Hz)					
		240	480	600	250	500	220/240		380/415		690	
N	NNG	65	35	25	22	35	65	35	50	25	20	10
H	HNG	100	65	35	25	50	100	50	70	35	30	15
L	LNG	200	100	65	42	65	200	100	100	50	35	17

Connectors for 75°C Wire

Construction	Ampere Rating	Wire Range	No. of cables per phase	Catalogue Number
Aluminum	300-1200A	1/0-500 kcmil Al/Cu	4	3TA4NG500 ^{③④}
Aluminum	300-1200A	500-750 kcmil Al/Cu	3	3TA3NG750 ^④
Copper	300-1200A	1/0-500 kcmil Cu	4	3TC4NG500 ^{③③}
Aluminum	300-1200A	1/0-500 kcmil Al/Cu	4	3TA4NG500H ^④
Compression Lugs				
	300-1200A	1/0-500 kcmil Al/Cu	—	12CLN500 ^①

① Total of 12 connectors (4 per phase Line or Load).

② For 100% rated NG breakers. Requires 90°C cable sized at 75°C ampacity.

③ Standard connector provided with complete breakers.

④ Kit consists of 3 terminal connectors.

NG Thermal-Magnetic, Instantaneous Trip Adjustment Range

Trip Unit Continuous Amp Rating (I _n)	Instantaneous Overcurrent Setting (I _i)	
	Min.	Max.
800	4000	8000
900	5000	10000
1000	5000	10000
1200	7000	12000

Note: Each breaker has 6 trip settings.

External Accessories page 5-195 - 5-209

VL Circuit Breakers

NG 1200A Thermal-Magnetic Trip Unit

Selection

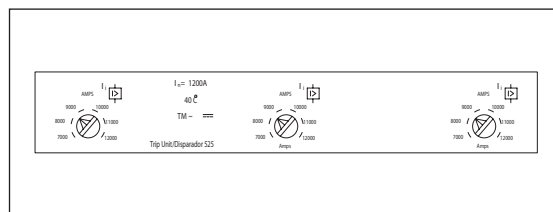

Model 525 Trip Unit

NG 1200A Frame 2-Pole with Thermal-Magnetic Trip Unit

Continuous Ampere Rating	N-Interrupting Class	H-Interrupting Class	L-Interrupting Class	Catalogue Number
	Catalogue Number	Catalogue Number	Catalogue Number	
	FRAME ONLY			
	NNG2F120	HNG2F120	LNG2F120	
COMPLETE FACTORY ASSEMBLED CIRCUIT BREAKER				TRIP UNIT ONLY
800	NNG2B800L	HNG2B800L	LNG2B800L	CNT2B800
900	NNG2B900L	HNG2B900L	LNG2B900L	CNT2B900
1000	NNG2B100L	HNG2B100L	LNG2B100L	CNT2B100
1200	NNG2B120L	HNG2B120L	LNG2B120L	CNT2B120

NG 1200A Frame 3-Pole with Thermal-Magnetic Trip Unit

Continuous Ampere Rating	N-Interrupting Class	H-Interrupting Class	L-Interrupting Class	Catalogue Number
	Catalogue Number	Catalogue Number	Catalogue Number	
	FRAME ONLY			
	NNG3F120	HNG3F120	LNG3F120	
COMPLETE FACTORY ASSEMBLED CIRCUIT BREAKER				TRIP UNIT ONLY
800	NNG3B800L	HNG3B800L	LNG3B800L	CNT3B800
900	NNG3B900L	HNG3B900L	LNG3B900L	CNT3B900
1000	NNG3B100L	HNG3B100L	LNG3B100L	CNT3B100
1200	NNG3B120L	HNG3B120L	LNG3B120L	CNT3B120

5
MOLDED CASE
CIRCUIT BREAKERS

VL Circuit Breakers

NG 1200A Electronic 3-Knob & LCD Trip Units

Selection

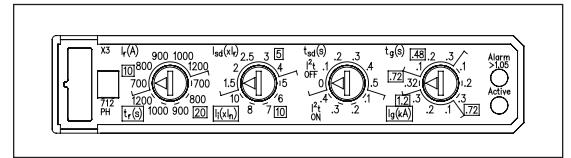
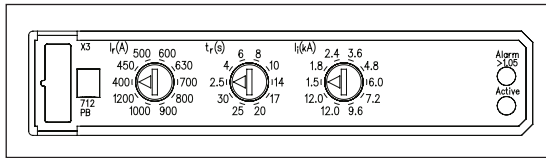

Model 555 Trip Units

NG 1200A Frame 3-Pole Electronic Trip Unit

Continuous Ampere Rating	N-Interrupting Class	H-Interrupting Class	L-Interrupting Class	Catalogue Number
	Catalogue Number	Catalogue Number	Catalogue Number	
	FRAME ONLY			
	NNG3F120	HNG3F120	LNG3F120	
COMPLETE FACTORY ASSEMBLED CIRCUIT BREAKER				TRIP UNIT ONLY
ELECTRONIC LI TRIP				
800	NNG3R800L	HNG3R800L	LNG3R800L	CNT3R800
1000	NNG3R100L	HNG3R100L	LNG3R100L	CNT3R100
1200	NNG3R120L	HNG3R120L	LNG3R120L	CNT3R120
ELECTRONIC LSI TRIP				
800	NNG3T800L	HNG3T800L	LNG3T800L	CNT3T800
1000	NNG3T100L	HNG3T100L	LNG3T100L	CNT3T100
1200	NNG3T120L	HNG3T120L	LNG3T120L	CNT3T120
ELECTRONIC LSIG TRIP				
800	NNG3V800L	HNG3V800L	LNG3V800L	CNT3V800
1000	NNG3V100L	HNG3V100L	LNG3V100L	CNT3V100
1200	NNG3V120L	HNG3V120L	LNG3V120L	CNT3V120
ELECTRONIC LIG TRIP				
800	NNG3W800L	HNG3W800L	LNG3W800L	CNT3W800
1000	NNG3W100L	HNG3W100L	LNG3W100L	CNT3W100
1200	NNG3W120L	HNG3W120L	LNG3W120L	CNT3W120

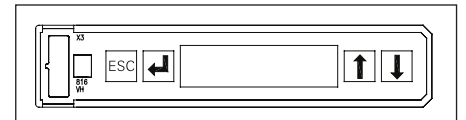

Model 586 Trip Unit

NG 1200A Frame 3-Pole Electronic LCD Trip Unit

Continuous Ampere Rating	N-Interrupting Class	H-Interrupting Class	L-Interrupting Class	Catalogue Number
	Catalogue Number	Catalogue Number	Catalogue Number	
	FRAME ONLY			
	NNG3F120	HNG3F120	LNG3F120	
COMPLETE FACTORY ASSEMBLED CIRCUIT BREAKER				TRIP UNIT ONLY
LCD ELECTRONIC LSI TRIP				
800	NNG3A800L	HNG3A800L	LNG3A800L	CNT3A800
1000	NNG3A100L	HNG3A100L	LNG3A100L	CNT3A100
1200	NNG3A120L	HNG3A120L	LNG3A120L	CNT3A120
LCD ELECTRONIC LSIG TRIP				
800	NNG3G800L	HNG3G800L	LNG3G800L	CNT3G800
1000	NNG3G100L	HNG3G100L	LNG3G100L	CNT3G100
1200	NNG3G120L	HNG3G120L	LNG3G120L	CNT3G120
LCD ELECTRONIC LSIG TRIP + GF ALARM ONLY				
800	NNG3K800L	HNG3K800L	LNG3K800L	CNT3K800
1000	NNG3K100L	HNG3K100L	LNG3K100L	CNT3K100
1200	NNG3K120L	HNG3K120L	LNG3K120L	CNT3K120

VL Circuit Breakers

Internal Accessories for MG 800A, NG 1200A, and PG 1600A Frames

Selection

Auxiliary Switch and Alarm Switch Combination Kits

Description	Mounting Pocket [Ⓞ]	Catalogue Number
2 Aux. + 2 Alarm Switches 2A + 2B Base AMBP2	Left Pocket Only	ASKP3
4 Aux. Switches 2A + 2B Base AMBP1	Left, Right	ASKP4

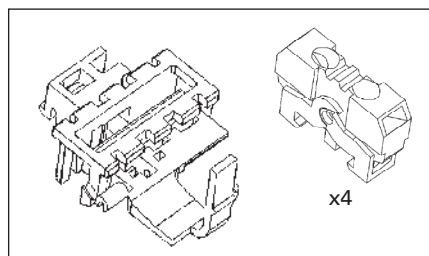

Auxiliary/Alarm Switch Mounting Base Only

Description	Mounting Pocket [Ⓞ]	Catalogue Number
Up to 4 Auxiliary Switches	Left, Right	AMBP1
2 Aux. + 2 Alarm Switches	Left Pocket Only	AMBP2

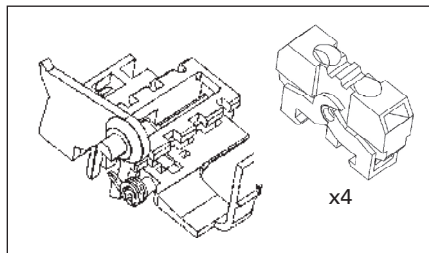

Auxiliary/Alarm Switch Only

Common to DG-PG Frames

Description	Catalogue Number
1 Normally Open Contact (1A)	ASWPA
1 Normally Closed Contact (1B)	ASWPB

Shunt Trips

Description	Mounting Pocket	Catalogue Number
24 VDC	Right Pocket Only	STRPB24DC
48-60 VDC		STRPC60DC
110-127 VDC		STRPD125DC
220-250 VDC		STRPE250DC
48-60 VAC		STRPM60
110-127 VAC		STRPN120
208-277 VAC		STRPS277
380-600 VAC		STRPV600

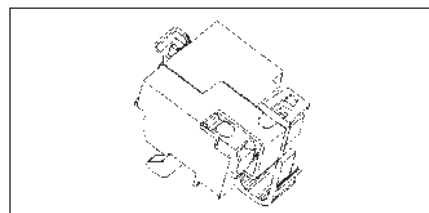

Undervoltage Release

Description	Mounting Pocket	Catalogue Number
12 VDC	Right Pocket Only	UVRPA12DC
24 VDC		UVRPB24DC
48 VDC		UVRPC48DC
60 VDC		UVRPG60DC
110-127 VDC		UVRPD125DC
220-250 VDC		UVRPE250DC
110-127 VAC		UVRPN120
220-240 VAC		UVRPR240
208 VAC		UVRPP208
277 VAC		UVRPS277
380-415 VAC		UVRPT415
440-480 VAC		UVRPU480

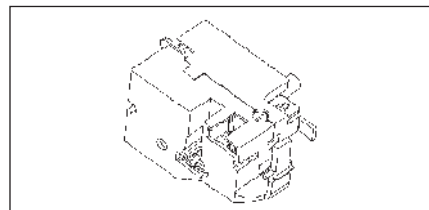

[Ⓞ] Refer to the "Accessory Locations" chart for guidelines and limitations about which pockets may be used for accessory combinations.

'A' refers to a normally open contact (open when the breaker contacts are open).

'B' refers to a normally closed contact (closed when the breaker contacts are open).

VL Circuit Breakers

PG 1600A Frame, VL Series & Thermal-Magnetic Trip Unit

Selection/Dimensions

Ordering Information

A complete factory assembled PG breaker includes the frame and trip unit only. The connectors must be ordered as separate items.

PG thermal-magnetic breakers sold as non-interchangeable only.

For any other configuration, order the frame, trip unit, and connectors as separate items.

Connectors require a Breaker Lug Mounting Assembly or Breaker Mounting Base and must be ordered as a separate item.

For DC applications, use Thermal magnetic trip unit only.

For reverse feed applications select non-interchangeable trip breakers only. Change the third digit of the catalogue number to "X" for non-interchangeable trip breakers.

For 100% rated breakers with a non-interchangeable trip unit, change the 3rd character of the catalogue number to "Y".

For special applications, refer to page 5-216.

Mounting hardware is included with each frame or complete breaker.

A Toggle Handle Extension is included with each frame or complete breaker.



Dimensions - Inches (mm)

Number of Poles	W	L	D	To Handle D1
2, 3	9 (229)	16 (406)	6 (152)	8.1 (207)

Shipping Weight, lbs. (kg)

Poles	Frame	Trip Unit	Complete Breaker
2, 3	60.2 (27.3)	8.8 (4.0)	69.0 (31.3)

PG Thermal-Magnetic, Instantaneous Trip Adjustment Range

Trip Unit Continuous Amp Rating (I _n)	Instantaneous Overcurrent Setting (I _i)	
	Min.	Max.
1200	7000	12000
1400	7000	12000
1600	7000	12000

Note: Each breaker has 6 trip settings in this range.

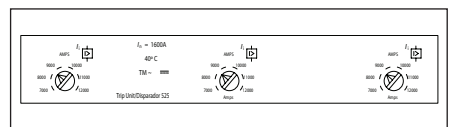

Model 525 Trip Unit

Interrupting Ratings

Interrupting Class	Breaker Type	RMS Symmetrical Amperes (KA)										
		CSA C22.2 NO.5 / UL 489					IEC 60947-2					
		Volts AC (50/60 Hz)			Volts DC		Volts AC (50/60 Hz)					
		240	480	600	250	500	220/240		380/415		690	
N	NPG	65	35	25	22	35	65	35	50	25	20	10
H	HPG	100	65	35	25	50	100	50	70	35	30	15
L	LPG	200	100	65	42	65	200	100	100	50	35	17

Connectors for 75°C Wire

Construction	Ampere Rating	Wire Range	No. of cables per phase	Catalogue Number
Aluminum	1200-1600A	1/0-750 kcmil Al/Cu	6	3TA6PG750 ^{①③}
Aluminum	1200-1600A	300-600 kcmil	5	TA5P600 ^{②④}
Aluminum	1200-1600A	600-750 kcmil	4	TA4P750 ^{②④}
Aluminum	1200-1600A	300-600 kcmil	6	TA6R600 ^{②④}
Copper	1200-1600A	300-600 kcmil	5	TC5R600 ^{②④⑤}

① Requires Lug Mounting Assembly LMAP1600.

② Requires Breaker Mounting Base MBPG1600 Kit or MBPG1601.

③ Consists of 3 connectors.

④ Consists of 1 connector.

⑤ For 100% rated PG breakers. Requires 90°C cable sized at 75°C ampacity.

Mounting Arrangement

Description	Catalogue Number
Lug Mounting Assembly	LMAP1600
Breaker Mounting Base (Front Connect)	MBPG1600
Breaker Mounting Base (Rear Connect)	MBPG1601

PG 1600A Frame 3-Pole with Thermal-Magnetic Trip Unit

Continuous Ampere Rating	N-Interrupting Class	H-Interrupting Class	L-Interrupting Class
	Catalogue Number	Catalogue Number	Catalogue Number
COMPLETE FACTORY ASSEMBLED CIRCUIT BREAKER			
1200	NPX3B120	HPX3B120	LPX3B120
1400	NPX3B140	HPX3B140	LPX3B140
1600	NPX3B160	HPX3B160	LPX3B160

External Accessories page 5-195 - 5-209

VL Circuit Breakers

PG 1600A Electronic 3-Knob & LCD Trip Units

Selection

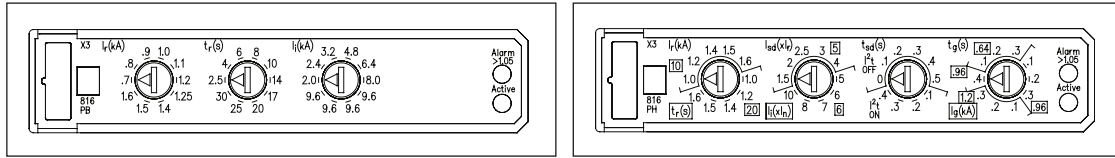

Model 555 Trip Unit

PG 1600A Frame 3-Pole Electronic Trip Unit

Continuous Ampere Rating	N-Interrupting Class	H-Interrupting Class	L-Interrupting Class	Catalogue Number
	Catalogue Number	Catalogue Number	Catalogue Number	
	FRAME ONLY			
	NPG3F160	HPG3F160	LPG3F160	
COMPLETE FACTORY ASSEMBLED CIRCUIT BREAKER				TRIP UNIT ONLY
ELECTRONIC LI TRIP				
1200	NPG3R120	HPG3R120	LPG3R120	CPT3R120
1600	NPG3R160	HPG3R160	LPG3R160	CPT3R160
ELECTRONIC LSI TRIP				
1200	NPG3T120	HPG3T120	LPG3T120	CPT3T120
1600	NPG3T160	HPG3T160	LPG3T160	CPT3T160
ELECTRONIC LSIG TRIP				
1200	NPG3V120	HPG3V120	LPG3V120	CPT3V120
1600	NPG3V160	HPG3V160	LPG3V160	CPT3V160
ELECTRONIC LIG TRIP				
1200	NPG3W120	HPG3W120	LPG3W120	CPT3W120
1600	NPG3W160	HPG3W160	LPG3W160	CPT3W160

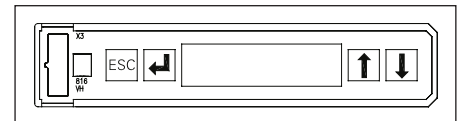

Model 586 Trip Unit

PG 1600A Frame 3-Pole Electronic LCD Trip Unit

Continuous Ampere Rating	N-Interrupting Class	H-Interrupting Class	L-Interrupting Class	Catalogue Number
	Catalogue Number	Catalogue Number	Catalogue Number	
	FRAME ONLY			
	NPG3F160	HPG3F160	LPG3F160	
COMPLETE FACTORY ASSEMBLED CIRCUIT BREAKER				TRIP UNIT ONLY
LCD ELECTRONIC LSI TRIP				
1200	NPG3A120	HPG3A120	LPG3A120	CPT3A120
1600	NPG3A160	HPG3A160	LPG3A160	CPT3A160
LCD ELECTRONIC LSIG TRIP				
1200	NPG3G120	HPG3G120	LPG3G120	CPT3G120
1600	NPG3G160	HPG3G160	LPG3G160	CPT3G160
LCD ELECTRONIC LSIG TRIP + GF ALARM ONLY				
1200	NPG3K120	HPG3K120	LPG3K120	CPT3K120
1600	NPG3K160	HPG3K160	LPG3K160	CPT3K160

5
MOLDED CASE
CIRCUIT BREAKERS

VL Circuit Breakers

Internal Accessories for MG 800A, NG 1200A, and PG 1600A Frames

Selection

Auxiliary Switch and Alarm Switch Combination Kits

Description	Mounting Pocket [ⓐ]	Catalogue Number
2 Aux. + 2 Alarm Switches 2A + 2B Base AMBP2	Left Pocket Only	ASKP3
4 Aux. Switches 2A + 2B Base AMBP1	Left, Right	ASKP4

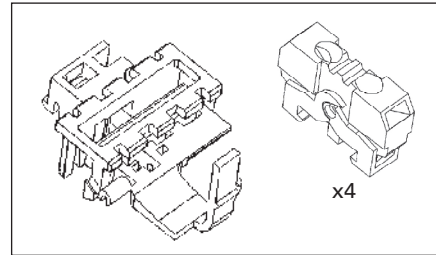

Auxiliary/Alarm Switch Mounting Base Only

Description	Mounting Pocket [ⓐ]	Catalogue Number
Up to 4 Auxiliary Switches	Left, Right	AMBP1
2 Aux. + 2 Alarm Switches	Left Pocket Only	AMBP2

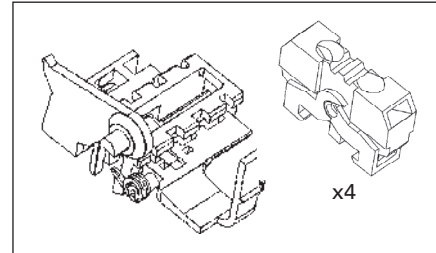

Auxiliary/Alarm Switch Only

Common to DG-PG Frames

Description	Catalogue Number
1 Normally Open Contact (1A)	ASWPA
1 Normally Closed Contact (1B)	ASWPB

Shunt Trips

Description	Mounting Pocket	Catalogue Number
24 VDC	Right Pocket Only	STRPB24DC
48-60 VDC		STRPC60DC
110-127 VDC		STRPD125DC
220-250 VDC		STRPE250DC
48-60 VAC		STRPM60
110-127 VAC		STRPN120
208-277 VAC		STRPS277
380-600 VAC		STRPV600

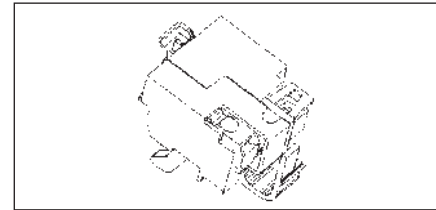

Undervoltage Release

Description	Mounting Pocket	Catalogue Number
12 VDC	Right Pocket Only	UVRPA12DC
24 VDC		UVRPB24DC
48 VDC		UVRPC48DC
60 VDC		UVRPG60DC
110-127 VDC		UVRPD125DC
220-250 VDC		UVRPE250DC
110-127 VAC		UVRPN120
220-240 VAC		UVRPR240
208 VAC		UVRPP208
277 VAC		UVRPS277
380-415 VAC		UVRPT415
440-480 VAC		UVRPU480

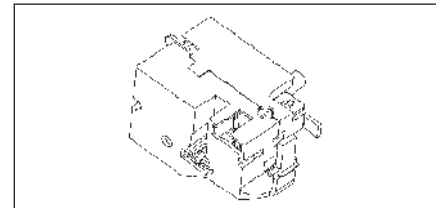

[ⓐ] Refer to the "Accessory Locations" chart for guidelines and limitations about which pockets may be used for accessory combinations.
 'A' refers to a normally open contact (open when the breaker contacts are open).
 'B' refers to a normally closed contact (closed when the breaker contacts are open).

Molded Case Circuit Breakers

Molded Case Switch

Selection

General

Typically a molded case switch is used when a compact load-break switch is needed for disconnect purposes. The VL line of molded case switches from Siemens is made of the same materials and components as the VL circuit breakers but do not provide overcurrent protection. Each molded case

switch has a fixed instantaneous self-protecting trip element which may open the switch under high fault conditions.

Application Note

Overcurrent protection must be provided by an appropriate overcurrent protective device located upstream

from the molded case switch. Also, the short-circuit current rating of the switch is limited to the interrupting rating of the upstream protective device or the ratings in the table below, **whichever is less.**

Ordering Information

Each type VL molded case switch accepts the same terminals and accessories as the equivalent VL circuit breakers.

All type VL molded case switches are suitable for reverse feed applications.

Mounting hardware and standard line and load terminals are included on ratings through 250A. For 400 – 1600A ratings, order the lugs separately.

All ratings are UL listed and CSA certified.

Molded Case Switch

Maximum Ampere Rating / Frame	2-Pole	3-Pole	Short-Circuit Current Rating ^①			Self Protective Instantaneous Override
	Catalogue Number	Catalogue Number	240V	480V	600V	
150A / DG	HDS2S150L	HDS3S150L	100k	65k	20k	2,500A
250A / FG	HFS2S250L	HFS3S250L	100k	65k	20k	3,500A
400A / JG	HJS2S400	HJS3S400	100k	65k	25k	4,400A
600A / LG	HLR2S600	HLR3S600	100k	65k	18k	5,500A
800A / MG	HMS2S800	HMS3S800	100k	65k	35k	6,500A
1200A / NG	HNS2S120	HNS3S120	100k	65k	35k	12,000A
1600A / PG	-	HPS3S160	100k	65k	35k	14,000A

Maximum Ampere Rating / Frame	3-Pole	Short-Circuit Current Rating ^①			Self Protective Instantaneous Override
	Catalogue Number	240V	480V	600V	
250A / FG	LFS3S250L	200k	100k	25k	3,500A
400A / JG	LJS3S400	200k	100k	25k	4,400A
600A / LG	LLR3S600	200k	100k	18k	5,500A
800A / MG	LMS3S800	200k	100k	65k	6,500A
1200A / NG	LNS3S120	200k	100k	65k	12,000A
1600A / PG	LPS3S160	200k	100k	65k	14,000A

^①The Short-Circuit Current Rating is the maximum available current of the circuit where the switch is used, when protected by an appropriate overcurrent protective device.

Molded Case Circuit Breakers

Motor Circuit Protectors

Selection

General

Protection of Motor Circuits

Molded case circuit breakers are used in motor circuits as a disconnecting means and for short-circuit protection. They should be used in conjunction with motor-running, over-current protection devices, and should permit the motor to start without nuisance tripping from motor-inrush current. The circuit breaker should have a continuous current rating of not less than 115% of the motor full-load current.

The recommended motor circuit protectors listed have continuous-current ratings of at least 115% of motor full-load currents. The trip setting positions are approximately 11 times motor full-load current. The suggested trip settings may need to be adjusted upward to no higher than 1300% of full-load current for non-design E type motors, and no greater than 1700% of full-load current for design E motors, to allow for motor startup due to in-rush current.

Breaker Mounted Immediately Ahead of Motor Starter

Siemens motor circuit protectors are recommended for use in combination motor starters to provide selective short-circuit protection for the motor branch circuit. The adjustable instantaneous trip feature of the Siemens motor circuit protector provides for a trip setting slightly above the peak motor in-rush current. With this setting, no delay is introduced in opening the circuit when a fault occurs. This circuit breaker has no time-delay trip element. Therefore it must be used in conjunction with, and immediately ahead of, the motor-running overcurrent protection device.

Important: The information below does not apply to all motor applications: it is recommended that the user refer to the National Electrical Code (NEC) for specific needs.

Table 1 (When Breaker is Mounted Immediately Ahead of Motor Starter)

3-Phase Induction Type Motors (Siemens motor circuit protectors for branch circuit use with alternating-current combination, full voltage motor starters)

Motor Full Load Amperes	Trip Setting (A)	Catalogue Number ^①
35-50	450	HDM3L150L
42-60	540	
48-70	630	
55-80	720	
62-90	810	
69-100	900	
58-83	750	HDM3M150L
69-100	900	
81-117	1050	
92-133	1200	
104-150	1350	
115-150 ^②	1500	
96-139	1250	HDM3H150L
115-150 ^②	1500	
135-150 ^②	1750	
135-150 ^②	2000	
135-150 ^②	2250	
135-150 ^②	2500	
46-67	600	HFM3L250L
55-80	720	
65-93	840	
74-107	960	
83-120	1080	
92-133	1200	
77-111	1000	HFM3M250L
92-133	1200	
108-156	1400	
123-178	1600	
138-200	1800	
154-222	2000	
135-194	1750	HFM3H250L
162-210	2100	
188-220	2450	
215-241	2800	
242-250 ^②	3150	
242-250 ^②	3500	

① Motor circuit protectors rated 150A and 250A are supplied with line and load lugs installed. If lugs are required on 400A to 1200A motor circuit breakers, order required lugs separately.

Motor Full Load Amperes	Trip Setting (A)	Catalogue Number ^①
96-139	1250	HJM3L400
115-167	1500	
135-194	1750	
154-222	2000	
173-250	2250	
192-278	2500	
154-222	2000	HJM3M400
185-267	2400	
215-311	2800	
246-356	3200	
277-400	3600	
308-400 ^②	4000	
154-222	2000	HLM3J600
185-267	2400	
215-311	2800	
246-356	3200	
277-400	3600	
308-444	4000	
212-306	2750	HLM3Y600
254-367	3300	
296-428	3850	
338-489	4400	
381-550	4950	
423-600	5500	
250-361	3250	HMM3M800
292-422	3800	
335-483	4350	
385-556	5000	
442-638	5740	
500-722	6500	
385-556	5000	HNM3M120
462-667	6000	
538-778	7000	
615-889	8000	
692-1000	9000	
769-1111	10,000	

② These settings are provided for starting currents greater than 11X but not to exceed 17X. Full Load Amps (FLA) not to exceed ampere rating of MCP.

VL External Accessories

Operating Mechanisms

Selection

Modularity To Support All Your Application Needs

Modules and More: VL Circuit Breakers with Optional Accessories

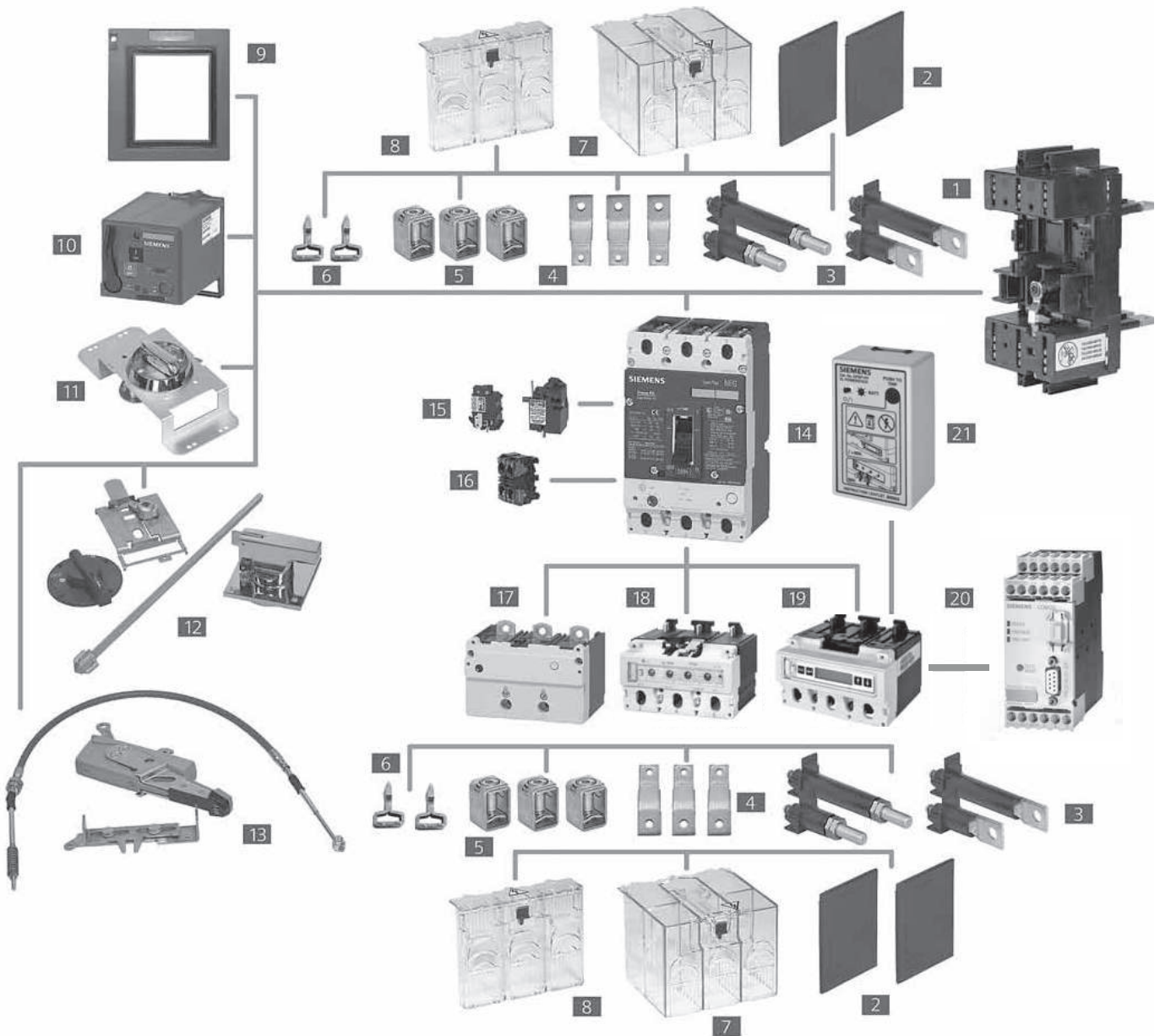

5
MOLDED CASE
CIRCUIT BREAKERS

- 1** Base for Plug-In or Draw-Out
- 2** Interphase Barriers
- 3** Rear Terminals – Flat and Round
- 4** Bus Extensions
- 5** Terminal Connectors
- 6** Plug-In Terminal Blades
- 7** Extended Terminal Shield
- 8** Standard Terminal Shield

- 9** Cover Frame for Door Cutout
- 10** Stored Energy Operator
- 11** Rotary Handle Operator
- 12** Variable Depth Rotary Operator
- 13** Max Flex Operator
- 14** Circuit Breaker
- 15** Shunt Trip or Undervoltage Releases
- 16** Auxiliary/Alarm Switches

- 17** Thermal Magnetic Trip Unit (525)
- 18** Electronic Trip Unit (555)
- 19** Elec. Trip Unit with LCD (586)
- 20** Communication Module with ZSI
- 21** Electronic Trip Unit Tester and LCB Power Supply

VL External Accessories

Operating Mechanisms

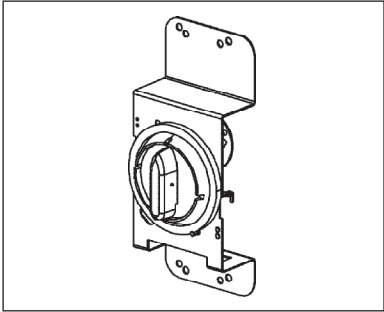
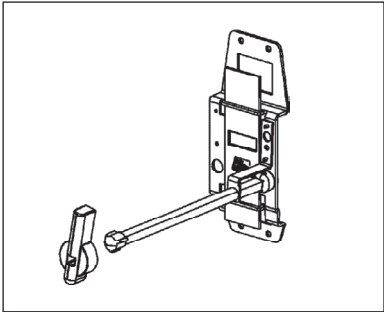
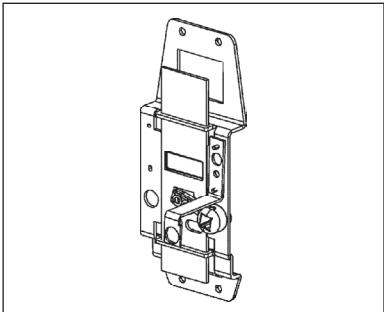
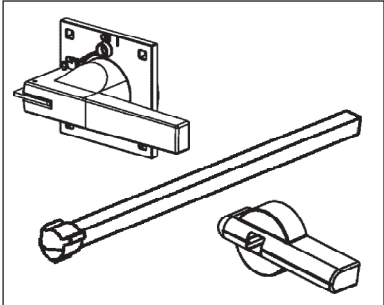
		For DG to FG Frame 150 to 250 A	For JG to LG Frame 400 A to 600 A
	Description	Catalogue Number	Catalogue Number
	Through-Door Rotary Handle Operator Kit Fixed depth and the handle is mounted directly on the circuit breaker. Lockable knob (for up to 3 padlocks). NEMA 1, 12	RHFF	RHFL
	Red Handle Version with red knob, yellow indicator plate NEMA 1, 12	RHFFEM	RHFLEM
	Door-Mounted Rotary Handle Operator Kit Variable depth, door mounted handle. Includes knob with masking frame, indicator plate, detachable door coupling, 12" shaft, and breaker mounted rotary operator. Lockable knob (for up to 3 padlocks). NEMA 1, 12	RHVF12	RHVL12
	Auxiliary Switch Kits For Direct or Extended Rotary Handle Operators (RHF and RHV). Form C, Early Break type2 Aux. Switch Kit [Ⓞ] Includes 1 switch with 5' wire For Door-Mounted Operator For Through-Door Operator	— RHSFA1F	RHSLA1 RHSLA1F
	Includes 2 switches with 5' wire For Door-Mounted Operator For Through-Door Operator	— RHSFA2F	RHSLA2 RHSLA2F
	Door-Mounted Rotary Operator Mechanism Breaker mechanism only	RHVFBM	RHVLBM
	Door-Mounted Rotary Handle Only Standard version NEMA 1, 12 NEMA 3R NEMA 4X Red Handle version	RHVM12H RHVM3RH RHVM4XH RHVMEMH	RHVM12H RHVM3RH RHVM4XH RHVMEMH
	NFPA-79 Handle Kit Intermediate handle for NFPA-79 compliance with door-mounted rotary operator	RHVF79H	RHVM79H
	Extension Shaft Only, for Door Mounted Operator 2 inches (50.8mm) 3 inches (76.2mm) 12 inches (304.8 mm) 16 inches (406.4 mm) 24 inches (609.6mm) w/ support bracket	RHVMS02 — RHVMS12 RHVMS16 RHVMS24	RHVMS02 — RHVMS12 RHVMS16 RHVMS24

Ⓞ During manual operation, Early Break auxiliary switch contacts open before the breaker opens.

Description	For MG Frame 800 A	For NG to PG Frame 1200 to 1600 A
	Catalogue Number	Catalogue Number
Through-Door Rotary Handle Operator Kit Fixed depth, breaker mounted. For direct fitting to the circuit breaker. Lockable with up to 3 padlocks. NEMA 1, 12 Red Handle Version with red knob, yellow indicator plate NEMA 1, 12	RHFM —	— —
Door-Mounted Rotary Handle Operator Kit Variable depth, door mounted handle. Includes knob with masking frame, indicator plate, detachable door coupling, 12" shaft, and breaker mounted rotary operator. Lockable knob (for up to 3 padlocks). NEMA 1, 12	RHVM12	—
Auxiliary Switch Kits For Direct or Extended Rotary Handle Operators (RHF and RHV). Early Break type2 Aux. Switch Kit Includes 1 switch with 5' wire For Door-Mounted Operator For Through-Door Operator Includes 2 switches with 5' wire For Door-Mounted Operator For Through-Door Operator	RHSMA1 — RHSMA2 —	RHSPA1 — RHSPA2 —
Door-Mounted Rotary Operator Mechanism Breaker mechanism only	RHVMBM	RHVPBM
Door-Mounted Rotary Handle Only Standard version NEMA 1, 12 NEMA 3R NEMA 4X Red Handle version	RHVM12H RHVM3RH RHVM4XH RHVMEMH	RHVP12H RHVP3RH RHVP4XH RHVPEMH
NFPA-79 Handle Kit Intermediate handle for NFPA-79 compliance with door-mounted rotary operator	RHVM79H	RHVP79H
Extension Shaft Only, for Door Mounted Operator 2 inches (50.8mm) 3 inches (76.2mm) 12 inches (304.8 mm) 16 inches (406.4 mm) 24 inches (609.6mm) w/ support bracket	RHVMS02 — RHVMS12 RHVMS16 RHVMS24	— RHVPS03 RHVPS12 — RHVPS24

VL External Accessories

Operating Mechanisms

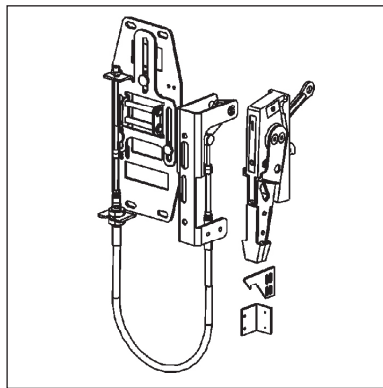
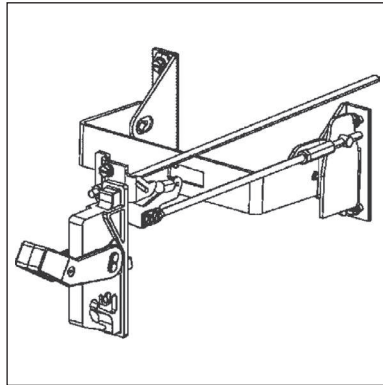

Description	For DG and FG Frame 150 to 250 A	For JG and LG Frame 400 to 600 A
	Catalogue Number	Catalogue Number
Variable Depth Flange Mounted Operator Kit Adjustable from 8" to 16" Complete kit, includes handle and variable depth operator. NEMA 1, 3R, 12 NEMA 4X IEC Black Handle NEMA 1, 3R, 12 NEMA 4X	FHVF3R FHVF4X FHVF3RB FHVF4XB	FHVL3R FHVL4X FHVL3RB FHVL4XB
Max-Flex™, Variable Depth Flange Mounted Operator Kit Complete kit, includes plastic handle, breaker operator, and cable. NEMA 1, 3R, 12 For DG and FG operators, the cable is 36", all others are 48" May be right- or left-hand mounted	MFKF3R	MFKL3R
Handle Only, for Max-Flex™ Variable Depth NEMA 1, 3R, 12 Plastic NEMA 1, 3R, 12 Steel - epoxy coated NEMA 4, 4X Steel - chrome plated Solid color (all gray) Plastic [Ⓞ] NEMA 1, 3R, 12 Solid color (black handle) Steel epoxy coated [Ⓞ] NEMA 1, 3R, 12	MFHM3R MFHM3RS MFHM4X MFHM3RB MFHM3RSB	MFHM3R MFHM3RS MFHM4X MFHM3RB MFHM3RSB
Breaker Operator Mechanism Only, for Max-Flex™	MFMF	MFML
Cable Only, for Max-Flex™ Variable Depth 36" 48" 60" 72" 84" 96" 120" 144"	MFCF036 MFCF048 MFCF060 MFCF072 MFCF084 MFCF096 MFCF120 MFCF144	MFCM036 MFCM048 MFCM060 MFCM072 MFCM084 MFCM096 MFCM120 MFCM144
Handle Auxiliary Switch Form C (1NO - 1NC), early break [Ⓞ] 1 Aux. switch 2 Aux. switch	MFSA1 MFSA2	MFSLA1 MFSLA2

Ⓞ Max-Flex™ handles are available with solid gray or black handles instead of the customary "Red for On" flange handle.

The black handle is preferred for IEC markets, where red handles have a specific meaning.

Ⓞ During manual operation, Early Break aux. contacts open before the breaker opens.

Description	For MG Frame 800 A	For NG Frame 1200 A	For PG Frame 1600 A
	Catalogue Number	Catalogue Number	Catalogue Number
Variable Depth Flange Mounted Operator Kit Adjustable from 8" to 16" Complete kit, includes handle and variable depth operator. NEMA 1, 3R, 12 NEMA 4X IEC Black Handle NEMA 1, 3R, 12 NEMA 4X	— — —	— — —	
Max-Flex™, Variable Depth Flange Mounted Operator Kit Complete kit, includes plastic handle, breaker operator, and cable. NEMA 1, 3R, 12 For DG and FG operators, the cable is 36", all others are 48" May be right- or left-hand mounted	MFKM3R	MFKP3RS	MFKP3RS
Handle Only, for Max-Flex™ Variable Depth NEMA 1, 3R, 12 Plastic NEMA 1, 3R, 12 Steel - epoxy coated NEMA 4, 4X Steel - chrome plated Solid color (all gray) Plastic [Ⓞ] NEMA 1, 3R, 12 Solid color (black handle) Steel epoxy coated [Ⓞ] NEMA 1, 3R, 12	MFHM3R MFHM3RS MFHM4X MFHM3RB MFHM3RSB	— MFHP3RS MFHP4X — MFHP3RSB	— MFHP3RS MFHP4X — MFHP3RSB
Breaker Operator Mechanism Only, for Max-Flex™	MFMM	MFMP	MFMP
Cable Only, for Max-Flex™ Variable Depth 36" 48" 60" 72" 84" 96" 120" 144"	MFCM036 MFCM048 MFCM060 MFCM072 MFCM084 MFCM096 MFCM120 MFCM144	— MFCP048 MFCP060 MFCP072 MFCP084 MFCP096 MFCP120 MFCP144	— MFCP048 MFCP060 MFCP072 MFCP084 MFCP096 MFCP120 MFCP144
Handle Auxiliary Switch Form C (1NO - 1NC), early break [Ⓞ] 1 Aux. switch 2 Aux. switch	MFSPA1 MFSPA2	MFSPA1 MFSPA2	MFSPA1 MFSPA2

Ⓞ Max-Flex™ handles are available with solid gray or black handles instead of the customary "Red for On" flange handle.
 The black handle is preferred for IEC markets, where red handles have a specific meaning.
 Ⓞ During manual operation, Early Break aux. contacts open before the breaker opens.

VL External Accessories

Operating Mechanisms

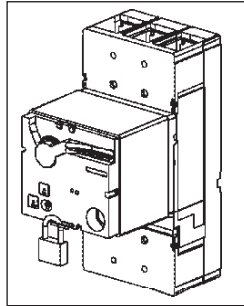

Description	For DG to FG Frame 150 to 250 A	
	Catalogue Number	
Stored Energy and Motor Operators Lockable with up to 3 padlocks.		
AC Voltage DC Voltage	Stored Energy Type	
— 24	SEAFB	
42-48 42-48	SEAFM	
60 60	SEAFY	
110-127 110-127	SEAFN	
220-250 220-250	SEAFR	
Cylinder Locks for Field Installation	CLKF	

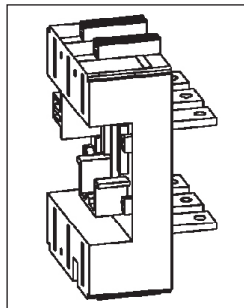

Description	For DG Frame 150 A	For FG Frame 250 A
	Catalogue Number	Catalogue Number
Plug-in Mounting Base Assembly Includes base, terminal blade kit, sec. terminal block assembly, base trip interlock, and mounting hardware.		
Rear Connected 3-pole	PCBDRC3	PCBFRC3
Front Connected 3-pole	PCBDFC3	PCBFFC3
Draw-out Assembly Includes base, position indicator switch, socket, base trip interlock, crank handle, connectors, and necessary shields.		
Rear Connected 3-pole	DCADRC3	DCAFR3
Front Connected 3-pole (Draw-out assembly includes side plates and all hardware)	DCADFC3	DCAFFC3
Hex Wrench for racking draw-out assembly and position indicator	DCHP	DCHP
Position Indicator Switch Form "C" switch to indicate breaker engaged/de-engaged position.Ⓢ	DCIP	DCIP
Secondary Terminal Block Assy. Accessory connections for plug-in or draw-out breakers. Pre-wired plug and block with 8 terminal points.Ⓢ	PCTF83	PCTF83
Plug-In Spare Breaker Kit Set of 6 terminal blades, 2 terminal shield, & 1 trip interlock	PCXD3	PCXF3
Draw-out Spare Breaker Kit Set of 6 terminal blades, & 1 trip interlock	DCXD3	DCXF3
Spare Breaker Trip Interlock	PCXFT	PCXFT

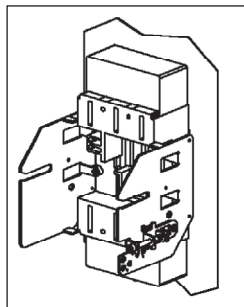
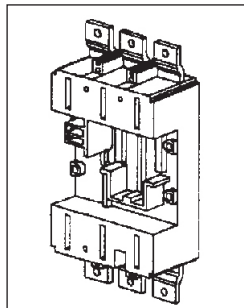

Ⓢ Up to 2 position indicator switches may be mounted per plug-in or draw-out base.

Ⓢ Up to 2 plugs per breaker (16 terminal points) may be mounted on DG, and FG breakers. Up to 3 plugs per breaker (24 terminal points) may be mounted on JG, LG, MG, NG, and PG breakers.

VL External Accessories

Connections

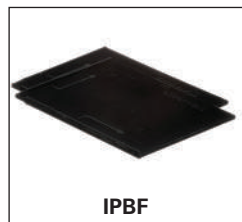
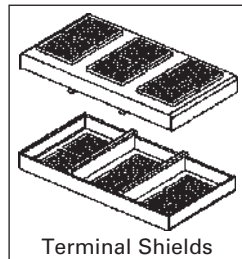
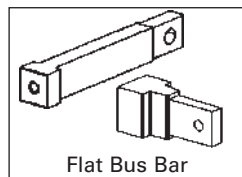
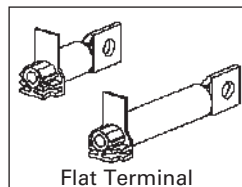
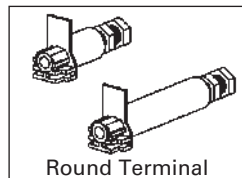
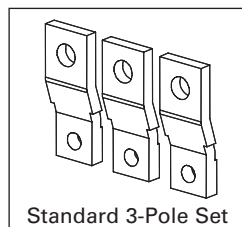

Description	For DG Frame 150 A	For FG Frame 250 A
	Catalog Number	Catalog Number
Front Bus Bar Connections Includes nut keeper plates and shield. Standard (straight) 3-Pole Set Bus Bar Connection Strap Kit Includes 6 - Bus Bars, 6 Nut Keepers & Shields 100% rated applications	FB3CD3 — —	FB3CF3 — —
Rear-Connecting Studs Short length round term. (1piece) Long length round term. (1piece) 3-Pole round term. kit, 2 short + 1 long Short length flat term. (1piece) Long length flat term. (1piece) 3-Pole flat term. kit, 2 short + 1 long Flat bus bar type (1 piece) 3-Pole set of flat bus bar	RTLDSR RTLDLR SRTDR3 RTLDSF RTLDLF SRTDF3 — —	RTLF3SR RTLF3LR SRTFR3 RTLF3SF RTLF3LF SRTFF3 — —
Terminal Shields Includes 2 terminal shields. 3-Pole Standard Shield 3-Pole Extended Shield	TSS3F3 TSL3F3	TSS3F3 TSL3F3
Interphase Barriers Set of 2 barriers Also fits plug-in and draw-out bases.	IPBF	IPBF
Lug Mounting Assy.	—	—
Breaker Mounting Base Front connected Rear connected	— —	— —







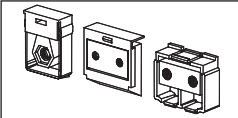
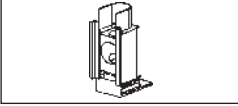

For JG Frame 400 A	For LG Frame 600 A	For MG Frame 800 A	For NG Frame 1200 A	For PG Frame 1600 A
Catalog Number	Catalog Number	Catalog Number	Catalog Number	Catalog Number
FBCJ3 —	FBCL3 —	FBCM3 —	SSBP SSBPH	SSBP SSBPH
RTLJSR RTLJLR SRTJR3 RTLJSF RTLJLF SRTJF3 — —	— — — — — — RTLLSF SRTL3F3	— — — — — — RTLMSF SRTMF3	— — — — — — RTLNSF SRTNF3	— — — — — — — —
TSSL3 TSLL3	— —	TSSM3 TSLM3	TSSP3 TSLP3	TSSP3 TSLP3
IPBM	IPBM	IPBM	IPBP	IPBP
—	—	—	—	LMAP1600®
— —	— —	— —	— —	MBPG1600 MBPG1601

Ⓞ Not for use with standard AI terminals. Use Standard Shield for rear connection and Extended Shield for bus-bar connection.

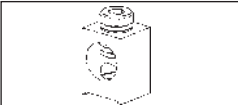
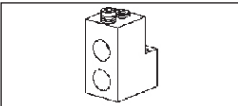
Ⓞ Kit includes connection for one side of breaker only. Order quantity 2 if connecting line and load side.

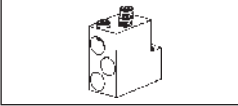
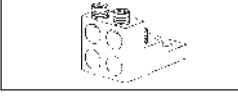
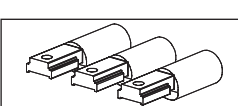
VL External Accessories

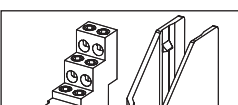
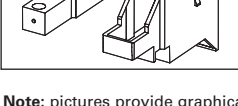
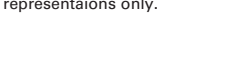
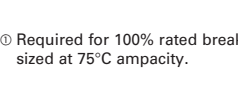
Connections

		For DG Frame 150 A	For FG Frame 250 A
	Description	Catalogue Number	Catalogue Number
	Nut Keeper Plates For ring/tongue terminal or bus bar connections. (For metric threads on other than the JG or LG frame, change "TNK" to "TMK") 1 Nut Keeper Plate Kit of 3	TNKD TNKD3	TNKF TNKF3
			
	Mechanical Lugs <i>Steel Wrap Around Body (Cu Wire Only)</i> Cable Size; (cables per phase) Single Lug Kit of 3	#8-1/0; 1-hole TW1DG20 3TW1DG20	#4-350 kcmil; 1-hole TW1FG350 3TW1FG350
	<i>Aluminum Body (Al or Cu Wire)</i> Cable Size; (cables per phase) Single Lug Kit of 2	#6-3/0; 1-hole TA1DG30 —	#4-350 kcmil; 1-hole TAW1FG350 —
	Kit of 3	3TA1DG30	3TAW1FG350
	Cable Size; (cables per phase) Single Lug Kit of 2 Kit of 3	— — —	— — —
	Cable Size; (cables per phase) Single Lug Kit of 3	— — —	— — —
	<i>Copper Body (Cu Wire Only)</i> Cable Size; (cables per phase) Single Lug Kit of 2	#6-3/0; 1-hole TC1DG30 [Ⓞ] —	#4-350 kcmil; 1-hole TCW1FG350 [Ⓞ] —
	Kit of 3	3TC1DG30 [Ⓞ]	3TCW1FG350 [Ⓞ]
	Cable Size; (cables per phase) Single Lug	— —	— —
	Compression Lugs Cable Size; (cables per phase) Kit of 2 Kit of 3	#14-2/0; 1-cable 2CLD20 3CLD20	#4-350 kcmil; 1-cable — 3CLF350
	Cable Size; (cables per phase) Kit of 2 Kit of 3	— —	— —
	Cable Size; (cables per phase) Kit of 3	— —	— —
	Distribution Lugs (Cu Wire Only) Cable Size; (cables per phase) Single Lug Kit of 3 Cable Size; (cables per phase) Single Lug Kit of 3	#14-#2; 3-hole TA3DG02 3TA3DG02 #14-#4; 6-hole TA6DG04 3TA6DG04	#14-#1; 2-hole and #14-2/0; 1-hole TA3FG20 3TA3FG20 #14-#4; 6-hole TA6FG04 3TA6FG04
	Control Wire Terminals Control Wire Terminal (Single) Control Wire Terminal (Kit of 3)	— —	— —

Note: pictures provide graphical representations only.

Ⓞ Required for 100% rated breakers. Requires 90°C cable sized at 75°C ampacity.

For JG Frame 400 A	For LG Frame 600 A	For MG Frame 800 A	For NG Frame 1200 A	For PG Frame 1600 A
Catalogue Number	Catalogue Number	Catalogue Number	Catalogue Number	Catalogue Number
TMKJ TMKJ3 <i>metric only</i>	TNKL TNKL3	TNKM TNKM3	TNKP TNKP3	TNKP TNKP3
1/0-600 kcmil; 1-hole TW1JG600 3TW1JG600	— — —	— — —	— — —	— — —
3/0-250 kcmil; 2-hole TA2JG250 — 3TA2JG250 AL: 250-750 kcmil CU: 3/0-600 kcmil; 1-hole TA1JG750 — 3TA1JG750 — — —	#2-600 kcmil; 2-hole — — 3TA2LG600LD ^① 3TA2LG600LN ^② AL: 250-750 kcmil CU: 3/0-600 kcmil; 1-hole TA1JG750 (400A max) — 3TA1JG750 (400A max) — — —	1/0-500 kcmil, 3-hole TA3MG500 3TA3MG500 500 -750 kcmil; 2-hole TA2MG750 — 3TA2MG750 #2-600 kcmil; 3-hole — 3TA3MG600 ^④	1/0-500 kcmil; 4-hole — 2TA4NG500 3TA4NG500 3TA4NG500H ^⑤ 500 -750 kcmil; 3-hole — 2TA3NG750 3TA3NG750 — —	1/0-750 kcmil; 6-hole — — 3TA6PG750 ^⑥ 600-750 kcmil; 4-hole TA4P750 ^⑥ — 300-600 kcmil; 5; 6-hole TA5P600 ^⑥ TA6R600 ^⑥ —
3/0-250 kcmil; 2-hole TC2JG250 ^③ — — 3/0-750 kcmil; 1-hole TC1JG750 ^③	#2-600 kcmil; 2-hole — — 3TC2LG600LD ^{①③} 3TC2LG600LN ^{②③} — —	1/0-500 kcmil; 3-hole TC3MG500 ^③ — — — —	1/0-500 kcmil; 4-hole — — 3TC4NG500 ^③ — —	— — — — 300-600 kcmil; 5-hole TC5R600 ^{③⑥}
#6-350 kcmil; 1-cable — 3CLJ350 250-600 kcmil; 1-cable 3CLJ600 — 250-750 kcmil; 1-cable 3CLJG750 —	#6-350 kcmil; 2-cable — 6CLL350 (kit of 6) 250-750 kcmil; 1-cable 3CLL750 — 250-600 kcmil; 2-cable 6CLL600 (kit of 6) —	— — — — — —	1/0-500 kcmil; 4-cable — 12CLN500 (kit of 12) — — — — —	— — — — — —
#14-#4; 12-hole TA12JG04 3TA12JG04 #14-2/0; 6-hole TA6JG20 3TA6JG20	— — — — —	— — — — —	— — — — —	— — — — —
TA2JG250PT —	— 3TA2LG600LNPT	TA3MG500PT —	— 3TA4NG500PT	— —

All lug kits include the nut keepers.

① Mounted on Load Side Only.

② Mounted on Line Side Only.

③ Required for 100% rated breakers. Requires 90°C cable

sized at 75°C ampacity.

④ Requires extended modified shield.

⑤ Used only with LMAP1600 mounting base.

⑥ Used only with MBPG1600 or MBPG1601 mounting base.

VL External Accessories

General

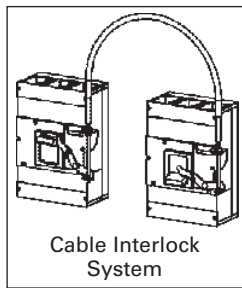
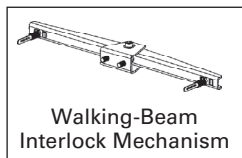
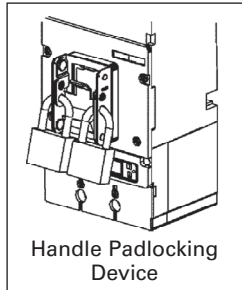

Description	For DG Frame 150 A	For FG Frame 250 A
	Catalogue Number	Catalogue Number
Handle Padlocking Device To padlock breaker toggle in the "OFF" position. Accepts up to 3 padlocks with 5–8 mm shackles.	HPLF	HPLF
Handle Blocking Device For holding the handle in the "ON" position. Not a lockout/tagout device.	HBDF	HBDF
Walking-Beam Interlock Mechanism Provides mechanical interlocking between two adjacent circuit breakers. Fixed mounted breakers Note: Both breakers must be of the same frame size.	WBMFFM	WBMFFM
Cable Interlock Mechanism Provides mechanical interlocking between 2 circuit-breakers - includes operator mechanism for one circuit breaker only. Combination with the next larger or smaller frame size is possible.	CBTF	CBTF
Interlock Cable Cable only, to connect 2 circuit breakers. Cable length 18 in. .46m (recommended up to 250A) Cable length 36 in. .91m (recommended from 400–800A) Cable length 54 in. 1.37m (recommended from 1200–1600A)	CBCF18 CBCM36 CBCP54	CBCF18 CBCM36 CBCP54
Mounting Screw Kit Includes the necessary hardware to mount a circuit breaker to the user's prepared surface Kit with 2 screws (SAE thread) Kit with 4 screws (SAE thread)	MSKF2 MSKF4	MSKF2 MSKF4
Trip Adjustment Sealing Cover Includes a trip unit cover to prevent tampering or adjustment of trip settings. Seal not included. Thermal-Magnetic Trip Units	TSCFTM	TSCFTM

VL External Accessories

Ground Sensors & Electronic Accessories

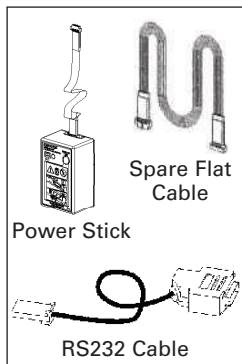
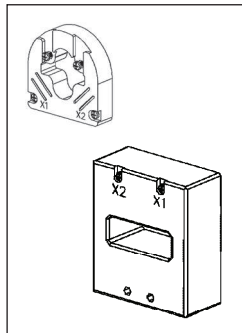

Description	For DG Frame 150 A	For FG Frame 250 A
	Catalogue Number	Catalogue Number
Neutral Current Transformer (Ground Sensor, N-pole) Neutral = 35/60A Neutral = 100A Neutral = 150A Neutral = 250A Neutral = 400A Neutral = 600A Neutral = 800A Neutral = 1000/1200A Neutral = 1600A	NGSD060 NGSF100 NGSF150 — — — — — — —	— NGSF100 NGSF150 NGSJ250 — — — — — —
Communications & Electronics Power Stick - Hand held, battery operated power supply for LCD trip units. (Requires two -9V batteries) For programming and trip testing only.	EPSP18V	EPSP18V
Com20 Profibus Communications Module with ZSI for electronic trip units (order cable separately)	COMPRO20	COMPRO020
Com21 Modbus Communications Module with ZSI for electronic trip units (order cable separately)	COMM021	COMM021
Cable for COM20/21 and power supply.....5ft. (1.5m)	COMKIT13	COMKIT13
Cable for COM20/21, 3.0m (9.8ft).	COMKIT6	COMKIT6
Spare flat cable for Test Kits	COMPCA	COMPCA
Addressing Plug - Assigns a field bus address without a PC by plugging into Com20/21	3UF79100AA00	3UF79100AA000

Door Cutouts & Extensions

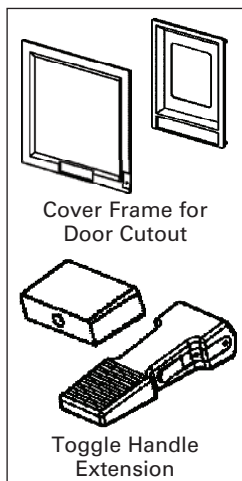

Cover Frame for Door Cutout For fixed or plug-in mounted circuit breakers. (IP30) 2-Pole & 3-Pole	BZLF3	BZLF3
For breakers with stored energy operator. (IP40)	BZLFRHSE	BZLFRHSE
Circuit-breaker draw-out mounted and toggle handle operated. Kit includes cover frame (bezel) and escutcheon as needed. (IP40) (not for use with rotary handle or stored energy operator)	BZLFBDC	BZLFBDC
Toggle Handle Extension For spare or replacement. (One is included with each NG - PG frame.)	—	—

For JG Frame 400 A	For LG Frame 600 A	For MG Frame 800 A	For NG Frame 1200 A	For PG Frame 1600 A
Catalogue Number	Catalogue Number	Catalogue Number	Catalogue Number	Catalogue Number
— — — NGSJ250 NGSL400 — — — —	— — — — NGSL400 NGSM600 — — — —	— — — — — NGSM600 NGSN800 — — —	— — — — — — NGSN800 NGSP120 —	— — — — — — — NGSP120 NGSP160
EPSP18V	EPSP18V	EPSP18V	EPSP18V	EPSP18V
COMPRO20	COMPRO20	COMPRO20	COMPRO20	COMPRO20
COMMOD21	COMMOD21	COMMOD21	COMMOD21	COMMOD21
COMKIT4	COMKIT4	COMKIT5	COMKIT5	COMKIT5
COMKIT7	COMKIT7	COMKIT8	COMKIT8	COMKIT8
COMPCA	COMPCA	COMPCA	COMPCA	COMPCA
3UF79100AA000	3UF79100AA000	3UF79100AA000	3UF79100AA000	3UF79100AA000
BZLL3	BZLL3	BZLM3	BZLP3	BZLP3
BZLLRHSE	BZLLRHSE	BZLMRHSE	BZLPRHSE	BZLPRHSE
BZLLBDC	BZLLBDC	BZLMBDC	BZLPBDC	BZLPBDC
THEL	THEL	THEM	THEP	THEP

VL Molded Case Circuit Breakers

Accessory Locations

Selection

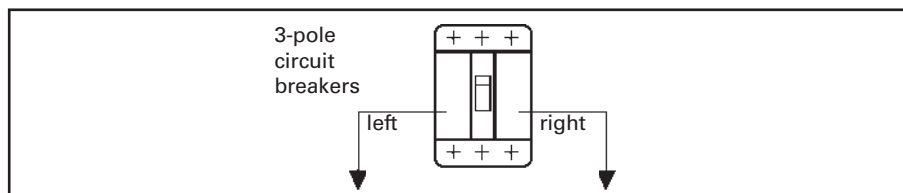

Locations of Internally Mounted Accessories

Frame Family	Left Pocket	Right Pocket
DG*, FG*, JG, LG 150 to 600A	Up to 2 Auxiliary Switches + 1 Alarm Switch	Shunt Trip or UVR or up to 3 Auxiliary Switches or up to 2 Auxiliary Switches + 1 Alarm Switch
		Shunt Trip or UVR or up to 3 Auxiliary Switches or up to 2 Auxiliary Switches + 1 Alarm Switch
MG, NG, PG 800 to 1600A	Up to 4 Auxiliary Switches	Shunt Trip or UVR or up to 4 Auxiliary Switches
	Up to 2 Auxiliary Switches + 2 Alarm Switches	Shunt Trip or UVR or up to 4 Auxiliary Switches

* Except DG and FG breakers with Electronic Trip Units. Due to the location of the Magnetic Latch, the Left Pocket is not available for accessories.

Accessory Information

- Aux. Switch is an Auxiliary Switch, 1A or 1B contact
- Alarm Switch has 1A or 1B contact
- UVR is an Undervoltage Release
- The standard location for factory mounted Auxiliary and Alarm Switches is the Left Pocket

Accessory Maximums

DG, FG, JG, LG Maximum Accessories:

- Maximum of six (6) switches total
- DG, FG Maximum of two (2) Alarm Switches, one each in the Left and Right Pockets. JG, LG Max. of 1 Alarm, Left only

MG, NG, PG Maximum Accessories:

- Maximum of eight (8) switches total
- Maximum of two (2) Alarm Switches, Left Pocket only

5

**MOLDED CASE
CIRCUIT BREAKERS**

VL Circuit Breakers

Suffix for factory mounted Switch Combinations

Selection

If the frame is:	And you need these functions:	Then add this suffix:	Device Catalog Number
DG, FG, JG or LG	1 Alarm Switch 1 NO Alarm 1 NC Alarm	A1	ASKL1
DG, FG, JG or LG	2 Aux. Switches 1 NO + 1 NC Aux. Contacts	A2	ASKL2
DG, FG, JG or LG	2 Aux. + 1 Alarm Switches 1 NO + 1NC Aux. and 1 NC Alarm 2 NO Aux. and 1 NC Alarm	A3	ASKL3
MG, NG or PG	2 Aux. + 2 Alarm Switches 1 NO + 1 NC Aux. and 1 NO + 1 NC Alarm 2 NO Aux. and 2 NC Alarm 2 NC Aux. and 2 NO Alarm	A3	ASKP3
MG, NG or PG	4 Aux. Switches 2 NO + 2 NC Aux.	A4	ASKP4

Suffix for factory mounted Shunt Trips

If the frame is:	And you need these functions:	Then add this suffix:	Device Catalog Number
DG, FG, JG or LG	24V DC 48-60V DC 110-127V DC "220-250V DC 48-60V AC" 110-127V AC 208-277V AC 380-600V AC	RB RC RD RE RM RN RS RV	STRLB24DC STRLC60DC STRLD125DC STRLE250DC STRLM60 STRLN120 STRLS277 STRLV600
MG, NG or PG	24V DC 48-60V DC 110-127V DC 220-250V DC 48-60V AC 110-127V AC 208-277V AC 380-600V AC	RB RC RD RE RM RN RS RV	STRPB24DC STRPC60DC STRPD125DC STRPE250DC STRPM60 STRPN120 STRPS277 STRPV600

Suffix for factory mounted Undervoltage Releases

If the frame is:	And you need these functions:	Then add this suffix:	Device Catalog Number
DG, FG, JG or LG	12V DC 24V DC 48V DC 60V DC 110-127V DC 220-250V DC 24V AC 110-127V AC 220-240V AC 208V AC 277V AC 380-415V AC 440-480V AC	UA UB UC UG UD UE UK UN UR UP US UT UU	UVRLA12DC UVRLB24DC UVRLC48DC UVRLG60DC UVRLD125DC UVRLE250DC UVRL24 UVRLN120 UVRLR240 UVRLP208 UVRLS277 UVRLT415 UVRLU480
MG, NG or PG	12V DC 24V DC 48V DC 60V DC 110-127V DC 220-250V DC 110-127V AC 220-240V AC 208V AC 277V AC 380-415V AC 440-480V AC	UA UB UC UG UD UE UN UR UP US UT UU	UVRPA12DC UVRPB24DC UVRPC48DC UVRPG60DC UVRPD125DC UVRPE250DC UVRPN120 UVRPR240 UVRPP208 UVRPS277 UVRPT415 UVRPU480

VL Technical Data

		DG	FG	JG	LG	MG	NG	PG
Max rated continuous current		150	250	400	600	800	1200	1600
Rated operational voltage								
NEMA	V AC	600	600	600	600	600	600	600
IEC	V AC	690	690	690	690	690	690	690
Rated impulse withstand voltage								
Main conducting paths	kV	8	8	8	8	8	8	8
Auxiliary circuits	kV	4	4	4	4	4	4	4
Ambient temperature range								
	°C	-25 to +75	-25 to +75	-25 to +75	-25 to +75	-25 to +75	-25 to +75	-25 to +75
High ambient derating (thermal-mag.)	50°C	93%	93%	93%	93%	95%	95%	95%
	60°C	86%	86%	86%	86%	86%	86%	80%
	70°C	80%	80%	80%	80%	80%	80%	74%
Operating cycles								
		20,000	20,000	20,000	10,000	5,000	3,000	3,000
Max switching rate (per hour)		120	120	120	60	60	30	30
Power loss (at max. rated current)								
Thermal-magnetic	W	15 – 48	32 – 80	60 – 175	85 – 230	170 – 250	150 – 220	200 – 260
Electronic trip unit	W	40	60	90	160	250	210	260
IEC ①								
Time constant t = 10 ms								
1 current path		—	—	—	—	—	—	—
2 current paths in series		—	—	—	—	—	—	—
3 current paths in series		—	—	—	—	—	—	—
Up to 250V DC		—	—	—	—	—	—	—
440V DC		—	—	—	—	—	—	—
600V DC		—	—	—	—	—	—	—
NEMA								
Time constant t = 8 ms								
2 poles switching		30	30	30	30	42	42	42
1 current path								
250V DC max.②								
3 poles switching		18	25	35	35	65	65	65
2 current paths in series								
500V DC max.②								
Accessories								
Auxiliary/Alarm switch								
Current rating (1 or 2 switches)		10	10	10	10	10	10	10
Current rating (3 or 4 same switch)	A	5	5	5	5	5	5	5
Shunt trip								
Pick-up voltage	V	0.7 – 1.1	0.7 – 1.1	0.7 – 1.1	0.7 – 1.1	0.7 – 1.1	0.7 – 1.1	0.7 – 1.1
Power consumption (short-time) at:								
48 – 60 V AC	VA	158 – 200	158 – 200	158 – 200	158 – 200	380 – 480	380 – 480	380 – 480
110 – 127 V AC	VA	136 – 158	136 – 158	136 – 158	136 – 158	302 – 353	302 – 353	302 – 353
208 – 277 V AC	VA	274 – 350	274 – 350	274 – 350	274 – 350	330 – 439	330 – 439	330 – 439
380 – 600 V AC	VA	158 – 237	158 – 237	158 – 237	158 – 237	243 – 384	243 – 384	243 – 384
24 V DC	W	110	110	110	110	360	360	360
48 – 60 V DC	W	110 – 172	110 – 172	110 – 172	110 – 172	512 – 820	512 – 820	512 – 820
110 – 127 V DC	W	220 – 254	220 – 254	220 – 254	220 – 254	302 – 353	302 – 353	302 – 353
220 – 250 V DC	W	97 – 110	97 – 110	97 – 110	97 – 110	348 – 397	348 – 397	348 – 397
Max. operating time	ms	50	50	50	50	50	50	50

① Consult Siemens for short circuit values.

② Review individual frame and type values.

VL Technical Data

Undervoltage trip		DG	FG	JG	LG	MG	NG	PG
Drop voltage (percentage)	V	35% – 70%	35% – 70%	35% – 70%	35% – 70%	35% – 70%	35% – 70%	35% – 70%
Pick-up voltage (percentage)	V	70% – 85%	70% – 85%	70% – 85%	70% – 85%	70% – 85%	70% – 85%	70% – 85%
Power consumption (continuous) at:								
110 – 127 V AC	VA	1.5	1.5	1.5	1.5	1.1	1.1	1.1
220 – 250 V AC	VA	1.5	1.5	1.5	1.5	2.1	2.1	2.1
208 V AC	VA	1.8	1.8	1.8	1.8	2.2	2.2	2.2
277 V AC	VA	2.1	2.1	2.1	2.1	1.6	1.6	1.6
380 – 415 V AC	VA	1.6	1.6	1.6	1.6	2.0	2.0	2.0
440 – 480 V AC	VA	1.8	1.8	1.8	1.8	2.3	2.3	2.3
500 – 525 V AC	VA	2.5	2.5	2.5	2.5	2.9	2.9	2.9
Max. opening time	ms	50	50	50	50	50	50	50
Motorized operating mechanism								
Motor with stored energy mechanism (synchronizable)		X	X	X	X	X	—	—
Motor Operator						—	X	X
Max. switching rate (per hour)		120	120	120	60	60	30	30
Command duration	ms	20 – 50	20 – 50	20 – 50	20 – 50	20 – 50	50	50
Closing time	ms	<100	<100	<100	<100	<100	<5,000	<5,000
Charging time	s	<5	<5	<5	<5	<5	<5	<5
Break time	s	<5	<5	<5	<5	<5	<5	<5
Power consumption	VA/W	<100	<100	<100	<100	<250	<250	<250
Control voltages 24 V DC								
42 – 48 V AC / DC								
60 V AC / DC								
110 – 127 V AC / DC								
220 – 250 V AC / DC								
Operating range: 85 – 110% of rated control voltage								

Technical Data

Unusual Operating Conditions

Reference

Note: The information provided on this and the next page is intended for reference and recommendation only. Because several variables can act on a circuit breaker's performance at the same time, the data below is based less on controlled testing, than on experience and engineering judgment. Contact Siemens for further information on special conditions and treatment.

High Ambient Temperatures

Because thermal-magnetic trip breakers are temperature sensitive and calibrated for a specific ambient of 40° C (104° F) (average enclosure temperature), a higher ambient will cause the breaker to trip at lower current than its nameplate rating, in other words, causing the breaker to "derate" (see Table 1). Similarly, the current carrying capacity of a circuit conductor is based upon a certain ambient temperature, a higher ambient will reduce its current carrying capacity, causing it to "derate." Thus, with a fluctuating temperature, a thermal-magnetic breaker will derate nearly parallel with its connected circuit conductors and maintain close circuit protection. If the application temperature exceeds 40° C (104° F) and is known, either a breaker specially calibrated for the higher ambient or one oversized according to Table 1 may be selected. In a case such as this, the circuit conductors should be oversized as well.

Siemens Electronic Trip Unit Breakers are insensitive to temperature changes. However, they do include circuitry to protect the components from abnormally high temperatures.

Altitude

Reduced air density at altitudes greater than 6600 ft. (2000 meters) affects the ability of a molded case circuit breaker to transfer heat and interrupt faults. Therefore, circuit breakers applied at these altitudes should have interrupting, insulation and continuous currents derated as indicated in Figure 1.

Table 1 – Temperature derating date for thermal-magnetic breakers

Reference Ampere Rating at 40° C (104° F)	Ampere Rating at:			Siemens Breaker Frames
	25° C (77° F)	50° C (122° F)	60° C (140° F)	
50	55	46	42	DG
60	66	56	52	
70	77	65	60	
90	99	84	78	
100	110	94	87	
125	137	114	100	
150	165	136	120	
175	192	159	140	
200	220	182	160	
225	247	205	180	
250	275	235	220	
300	330	276	252	
350	385	325	301	
400	440	372	340	
500	550	468	435	
600	660	564	525	
700	770	658	613	
800	880	754	704	
900	990	828	749	
1000	1100	900	825	
1200	1320	1090	1000	
1400	1540	1304	1148	
1600	1760	1500	1320	

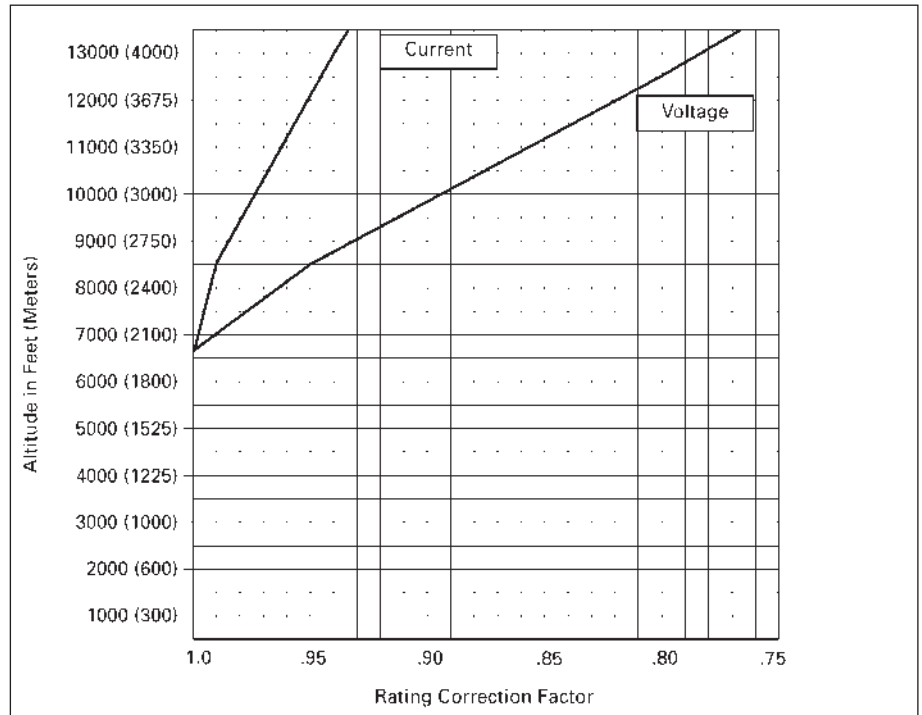

Figure 1 – Altitude adjustment

Technical Data

Unusual Operating Conditions

Reference

Unusual Operating Conditions 400 Hz Systems

Circuit Breaker Derating Required

This table lists the maximum continuous current carrying capacity for Siemens breakers at 400Hz. Due to the increased resistance of the copper sections resulting from the skin effect produced by eddy currents at these frequencies, circuit breakers in many cases require derating. The thermal derating on these devices is based upon 100%, three phase application in open air in a maximum of 40°C (104° F) with 48 in. (1219 mm) of the specified cable or bus at the line and load side. Additional derating of not less than 20% will be required if the circuit breaker is to be utilized in an enclosure. Further derating may be required if the enclosure ambient temperature exceeds 40°C(104° F).

Cable and Bus Sizing

The cable and bus sizes to be utilized at 400Hz are not based on standard National Electric Codes tables for 60Hz application. Larger cross sections are necessary at 400Hz. All bus bars specified are based upon mounting the bars in the vertical plane to allow maximum air flow. All bus bars are spaced at a minimum of 0.25 in. (6 mm) apart. Mounting of bus bars in the horizontal plane will necessitate additional drafting. Edgewise orientation of the bus may change the maximum ratings indicated. If additional information is required for other connections of cable or bus, contact Siemens for information.

Application Recommendations

It is recommended that temperatures be measured on the line and load terminals or T-connectors of the center pole. These are usually the hottest terminals with a balanced load. A maximum temperature of 75°C (35°C over a maximum ambient of 40°C) would verify the particular application. Temperature profiles taken on these breakers can be correlated to ensure that the hottest points within the breaker are within the required temperature limits.

Interrupting Rating

Circuit breakers used in 400 Hz systems are limited to a 5000 A interrupting rating. If higher ratings are required, consult Siemens.

Breaker type	Maximum continuous ampere rating at 40°C (104°F)®			75°C (167F) Copper cable per pole	
	60HZ		400HZ	No of pieces	Wire size
	Open air	Open air®	Enclosed after derating		
DG	50	48	38	1	#8
	60	57	46	1	#6
	70	63	50	1	#4
	80	72	58	1	#4
	90	80	64	1	#3
	100	90	72	1	#3
	110	95	75	1	#2
	125	105	84	1	#1
FG	150	125	100	1	#1/0
	100	90	72	1	#3
	110	95	75	1	#2
	125	105	84	1	#1
	150	125	100	1	#1/0
	175	140	112	1	#2/0
	200	160	128	1	#3/0
	225	180	144	1	#4/0
JG	250	200	160	1	250 kcmil
	250	210	168	1	250 kcmil
	300	240	192	1	350 kcmil
	350	260	208	1	500 kcmil
JG 100% Rated	400	300	240	2	#2/0
	250	210	210	1	250 kcmil
	300	240	240	1	350 kcmil
	350	260	260	1	500 kcmil
LG	400	300	300	2	#3/0
	400	300	240	2	#3/0
	500	375	300	2	250 kcmil
	600	420	336	2	350 kcmil

Breaker type	Maximum continuous ampere rating at 40°C (104°F)®			75°C (167F) Copper cable per pole	
	60HZ		400HZ	No of pieces	Wire size
	Open air	Open air®	Enclosed after derating		
LG	400	300	240	2	#3/0
	500	375	300	2	250 kcmil
	600	420	336	2	350 kcmil
	600	430	360	2	350 kcmil
MG	700	500	400	3	250 kcmil
	800	560	448	3	300 kcmil
MG 100% Rated	600	430	430	2	350 kcmil
	700	500	500	3	250 kcmil
NG	800	560	560	3	300 kcmil
	900	600	448	3	300 kcmil
	1000	650	480	3	350 kcmil
	1200	780	624	4	400 kcmil
NG 100% Rated	900	600	600	3	350 kcmil
	1000	650	650	3	400 kcmil
PG	1200	780	780	4	350 kcmil
	1200	780	624	4	400 kcmil
	1400	850	680	4	500 kcmil
PG 100% Rated	1600	960	768	5	500 kcmil
	1200	780	780	4	400 kcmil
PG 100% Rated	1400	850	850	4	500 kcmil
	1600	960	960	5	500 kcmil

® The information provided on this page is intended for reference and recommendation only. Because several variables can act on a circuit breaker's performance at the same time, the data above is based less on controlled testing, than on experience and engineering

judgment. Contact Siemens for further information on special conditions and treatment.

® Additional derating may be required if the ambient temperature is greater than 40°C (104°F).

® Calculated after derating to compensate for the heating of the copper conductor, caused by the skin effect generated by eddy currents produced at 400/415HZ.

Molded Case Circuit Breakers

Series Connected Short Circuit Ratings

General

The term "Series Connected Short Circuit Rating" refers to the application of series circuit breakers in a combination that allows downstream breakers to have lower individual interrupting ratings than the available fault current.

This is permitted as long as the series combination has been tested and certified by CSA.

The tables on these pages list specific main and branch breaker combinations that may be used for the short circuit interrupting ratings shown.

No substitutions are permitted. All combinations shown have been tested and are CSA Certified. This information is provided as a reference tool only.

240V Series Ratings

Series Rating	Main Breaker		Branch Breaker				
	Max. Amps	Type	Type	Poles	Amps	Volts	
22,000	70 125 100	QPH,BQH,BLH 70(1P) 125(2P) 100(3P)	QP,BQ,BL	1	15-70	120/240	
				2	15-125	120/240	
				2	15-125	240	
				3	15-100	240	
			QT	1,2	15-50	120/240	
			QPF,BQF,BLF	1	15-30	120	
			QE,BE,BLE	1	15-30	120	
			QPF2,BLF2	1	15-30	120	
			QAF,BQAF,BAF	1	15-20	120	
			QAF2,BAF2	1	15-20	120	
			QFGA2,BFGA2	1	15-20	120	
			QPF,BLF	2	15-60	120/240	
			QE,BLE	2	15-60	120/240	
			QAF,BAF	2	15-20	120/240	
			QPH,BQH,BLH 100(3P)	70(1P)	QT	1	15-50
	125	EQ967# (2P)	QP,BQ,BL		1	15-70	120/240
					2	15-125	120/240
			QT	1,2	15-50	120/240	
			QPF,BQF,BLF	1	15-30	120	
			QPF,BLF,SPF	2	15-60	120/240	
			QE,BE,BLE	1	15-30	120	
			2	15-60	120/240		
			QAF,BQAF,BAF	1	15-20	120	
			QAF,BAF	2	15-20	120/240	
	QAF2,BAF2	1	15-20	120			
	200	EQ968# (2P)	QP,BQ,BL	1	15-70	120/240	
				2	15-125	120/240	
			QT	1,2	15-50	120/240	
			QPF,BQF,BLF	1	15-30	120	
			QPF,BLF	2	15-60	120/240	
			QE,BE,BLE	1	15-30	120	
			2	15-60	120/240		
			QPF2,BLF2	1	15-30	120	
			QAF,BQAF,BAF	1	15-20	120	
			QAF,BAF	2	15-20	120/240	
			QAF2,BAF2	1	15-20	120	
			QFGA2,BFGA2	1	15-20	120	
			QNH,QNRH (2P)	QP,BQ,BL	1	15-70	120/240
					2	15-125	120/240
				QT	1,2	15-50	120/240
		QPF,BQF,BLF		1	15-30	120	
		QPF,BLF		2	15-60	120/240	
QE,BE,BLE		1		15-30	120		
2		15-60	120/240				
QPF2,BLF2		1	15-30	120			
QAF,BQAF,BAF		1	15-20	120			
QAF,BAF	2	15-20	120/240				
QAF2,BAF2	1	15-20	120				
QFGA2,BFGA2	1	15-20	120				

240V Series Ratings (Continued)

Series Rating	Main Breaker		Branch Breaker				
	Max. Amps	Type	Type	Poles	Amps	Volts	
22,000	225	QPPH (2P)	QP,BQ,BL	1	15-70	120/240	
				2	15-125	120/240	
			QT	1,2	15-50	120/240	
			QPF,BQF,BLF	1	15-30	120	
			QPF,BLF	2	15-60	120/240	
			QE,BE,BLE	1	15-30	120	
			2	15-60	120/240		
			QPF2,BLF2	1	15-30	120	
			QAF,BQAF,BAF	1	15-20	120	
			QAF,BAF	2	15-20	120/240	
			QAF2,BAF2	1	15-20	120	
			QFGA2,BFGA2	1	15-20	120	
			QPP	2	125-200	120/240	
			EQ948#	2	125-200	120/240	
			QJH2 (2, 3P)	QP,BQ,BL	1	15-70	120/240
		2			15-125	120/240	
		2			15-125	240	
		QT		1,2	15,20,40	120/240	
		QPF,BQF,BLF		1	15-30	120	
		QPF,BLF		2	15-60	120/240	
		QE,BE,BLE		1	15-30	120	
	2	15-60		120/240			
	EQ948#	2		125-200	120/240		
	QJH2 (3P)	QP,BQ,BL	3	60-100	240		
	250	QRH2 (2, 3P)	QP,BQ,BL	1	15-70	120/240	
				2	15-125	120/240	
				2	15-125	240	
			QT	1,2	15-50	120/240	
			QPF,BQF,BLF	1	15-30	120	
			QPF,BLF	2	15-60	120/240	
			QE,BE,BLE	1	15-30	120	
			QE,BLE	2	15-60	120/240	
			QPF2,BLF2	1	15-30	120	
			QAF,BQAF,BAF	1	15-20	120	
			QAF,BAF	2	15-20	120	
			QAF2,BAF2	1	15-20	120	
			QFGA2,BFGA2	1	15-20	120	
			QRH2 (3P)	QP,BQ,BL	3	15-100	240
			42,000	225	QJ2H (2, 3P)	QP,BQ,BL	1
	2	15-125					120/240
	QPH	1				15-70	120/240
	2	15-125				120/240	
BQH,BLH	1	15-70				120/240	
2	15-125	120/240					
EQ967#	2	100-125				120/240	
QJH2	2	60-225				240	
QJ2H (3P)	QP,BQ,BL	3				60-100	240
		QPH			3	15-100	240
	BQH,BLH	3			15-100	240	
		QJH2			3	60-225	240

Molded Case Circuit Breakers

Series Connected Short Circuit Ratings

General

240V Series Ratings (Continued)

240V Series Ratings (Continued)

Series Rating	Main Breaker		Branch Breaker				
	Max. Amps	Type	Type	Poles	Amps	Volts	
65,000	70	HQPHBQ,HBL 70(1P)	QP,BQ,BL	1	15-70	120/240	
			QPH	1	15-70	120/240	
			BQH,BLH	1	15-70	120/240	
			QT	1	15-50	120/240	
	125	HQPHBQ,HBL 125(2P)	QP,BQ,BL	1	15-70	120/240	
				2	15-125	120/240	
			QPH	1	15-70	120/240	
				2	15-125	120/240	
			BQH,BLH	1	15-70	120/240	
				2	15-125	120/240	
EQ967#	2	100-125	120/240				
100	HQPHBQ,HBL 100(3P)	QP,BQ,BL	1	15-70	120/240		
			2	15-100	120/240		
			2	15-100	240		
			3	15-100	240		
			QPH	1	15-70	120/240	
				2	15-100	120/240	
		3		15-100	240		
		BQH,BLH	1	15-70	120/240		
			2	15-100	120/240		
			3	15-100	240		
		125 100	HQPHBQ,HBL 125(2P) 100(3P)	QT	1,2	15-50	120/240
				QPF,BLF	2	15-60	120/240
QE,BLE	2			15-60	120/240		
QPHF,BLHF	2			15-60	120/240		
QEH,BLEH	2			15-60	120/240		
70 125 100	HQPHBQ,HBL 70(1P) 125(2P) 100(3P)	QPF,BQF,BLF	1	15-30	120		
		QE,BE,BLE	1	15-30	120		
		QPHF,BQHF	1	15-30	120		
		BLHF	1	15-30	120		
		QEH,BLEH	1	15-30	120		
		QPF2,BLF2	1	15-30	120		
		QPHF2,BLHF2	1	15-30	120		
		QAF,BQAF,BAF	1	15-20	120		
		QAFH,BQAFH	1	15-20	120		
		BAFH	1	15-20	120		
		QAF2,BAF2	1	15-20	120		
		QAFH2,BAFH2	1	15-20	120		
		QFGA2,BFGA2	1	15-20	120		
		QFGAH2,BFGAH2	1	15-20	120		
100	ED4 (1P)	QP,BQ,BL	1	15-70	120		
		QPH	1	15-70	120		
		BQH,BLH	1	15-70	120		
		QT	1	15-50	120		
		QPF,BQF,BLF	1	15-30	120		
		QE,BE,BLE	1	15-30	120		
		QPHF,BQHF	1	15-30	120		
		BLHF	1	15-30	120		
		QEH,BLEH	1	15-30	120		
		QPF2,BLF2	1	15-30	120		
		QPHF2,BLHF2	1	15-30	120		
		QAF,BQAF,BAF	1	15-20	120		
		QAFH,BQAFH	1	15-20	120		
		BAFH	1	15-20	120		
		QAF2,BAF2	1	15-20	120		
		QAFH2,BAFH2	1	15-20	120		
		QFGA2,BFGA2	1	15-20	120		
		QFGAH2,BFGAH2	1	15-20	120		
		ED2	1	15-100	120		
		125	ED4,ED6 (2, 3P)	QP,BQ,BL	1	15-70	120/240
					2	15-125	120/240
					2	15-125	240

Series Rating	Main Breaker		Branch Breaker					
	Max. Amps	Type	Type	Poles	Amps	Volts		
65,000	125	ED4,ED6 (2, 3P)	QPH	1	15-70	120/240		
				2	15-125	120/240		
			BQH,BLH	1	15-70	120/240		
				2	15-125	120/240		
			QT	1,2	15-50	120/240		
			QPF,BQF,BLF	1	15-30	120		
			QPF,BLF	2	15-60	120/240		
			QE,BE,BLE	1	15-30	120		
			QE,BLE	2	15-60	120/240		
			QPHF,BQHF	1	15-30	120		
			QPHF,BLHF	2	15-60	120/240		
			BLHF	1	15-30	120		
			QEH,BLEH	1	15-30	120		
			2	15-60	120/240			
			QPF2,BLF2	1	15-30	120		
			QPHF2,BLHF2	1	15-30	120		
			QAF,BQAF,BAF	1	15-20	120		
			QAFH,BQAFH	1	15-20	120		
			BAFH	1	15-20	120		
			QAF2,BAF2	1	15-20	120		
			QAFH2,BAFH2	1	15-20	120		
			QFGA2,BFGA2	1	15-20	120		
			QFGAH2,BFGAH2	1	15-20	120		
			ED2	1	15-100	120		
			2	15-100	240			
			ED4,ED6 (3P)	QP,BQ,BL	3	15-100	240	
				QPH	3	15-100	240	
				BQH,BLH	3	15-100	240	
				ED2	3	15-100	240	
			150	NDGA,NDGB (2, 3P)	QPH,BQH,BLH	1	15-70	120/240
						2	15-125	120/240
			NDGA,NDGB (3P)	QPH,BQH,BLH	3	15-100	240	
			200	HQN,HQNR (2P)	QP,BQ,BL	1	15-70	120/240
						2	15-125	120/240
					QPH,BQH,BLH	1	15-70	120/240
						2	15-125	120/240
					QT	1,2	15-50	120/240
					QPF,BQF,BLF	1	15-30	120
					QPF,BLF	2	15-60	120/240
					QE,BE,BLE	1	15-30	120
					2	15-60	120/240	
					QPHF,BQHF	1	15-30	120
QPHF,BLHF	2	15-60			120/240			
BLHF	1	15-30			120			
QEH,BLEH	1	15-30			120			
2	15-60	120/240						
QPF2,BLF2	1	15-30			120			
QPHF2,BLHF2	1	15-30			120			
QAF,BQAF,BAF	1	15-20			120			
QAFH,BQAFH	1	15-20			120			
BAFH	1	15-20			120			
QAF2,BAF2	1	15-20			120			
QAFH2,BAFH2	1	15-20			120			
QFGA2,BFGA2	1	15-20			120			
QFGAH2,BFGAH2	1	15-20	120					
EQ967#	2	100-125	120/240					
EQ968#	2	150-200	120/240					
225	HQPP (2P)	QP,BQ,BL	1	15-70	120/240			
			2	15-125	120/240			
		QPH	1	15-70	120/240			
			2	15-125	120/240			

Molded Case Circuit Breakers

Series Connected Short Circuit Ratings

General

240V Series Ratings (Continued)

240V Series Ratings (Continued)

Series Rating	Main Breaker		Branch Breaker				
	Max. Amps	Type	Type	Poles	Amps	Volts	
65,000	225	HQPP (2P)	BQH,BLH	1	15-70	120/240	
				2	15-125	120/240	
			QT	1,2	15-50	120/240	
			QPF,BQF,BLF	1	15-30	120	
			QPF,BLF	2	15-60	120/240	
			QE,BE,BLE	1	15-30	120	
			QE,BLE	2	15-60	120/240	
			QPHF,BQHF	1	15-30	120	
			QPHF,BLHF	2	15-60	120/240	
			BLHF	1	15-30	120	
			QEH,BLEH	1	15-30	120	
				2	15-60	120/240	
			QPF2,BLF2	1	15-30	120	
			QPHF2,BLHF2	1	15-30	120	
			QAF,BQAF,BAF	1	15-20	120	
			QAFH,BQAFH	1	15-20	120	
			BAFH	1	15-20	120	
			QAF2,BAF2	1	15-20	120	
			QAFH2,BAFH2	1	15-20	120	
			QFGA2,BFGA2	1	15-20	120	
			QFGAH2,BFGAH2	1	15-20	120	
			EQ967#	2	100-125	120/240	
			QPP	2	125-200	120/240	
			QPPH	2	125-200	120/240	
			EQ968#	2	150-200	120/240	
			EQ978# (2P)	QP,BQ,BL	1	15-70	120/240
					2	15-125	120/240
				QPH	1	15-70	120/240
					2	15-125	120/240
				BQH,BLH	1	15-70	120/240
		2			15-125	120/240	
		QT		1,2	15-50	120/240	
		QPF,BQF,BLF		1	15-30	120	
		QPF,BLF		2	15-60	120/240	
		QE,BE,BLE		1	15-30	120	
		QE,BLE		2	15-60	120/240	
		QPHF,BQHF		1	15-30	120	
		QPHF,BLHF		2	15-60	120/240	
		BLHF		1	15-30	120	
		QEH,BLEH		1	15-30	120	
				2	15-60	120/240	
		QPF2,BLF2		1	15-30	120	
		QPHF2,BLHF2		1	15-30	120	
		QAF,BQAF,BAF		1	15-20	120	
		QAFH,BQAFH		1	15-20	120	
		BAFH		1	15-20	120	
		QAF2,BAF2		1	15-20	120	
		QAFH2,BAFH2		1	15-20	120	
		QFGA2,BFGA2		1	15-20	120	
		QFGAH2,BFGAH2		1	15-20	120	
		EQ967#		2	100-125	120/240	
		QPP		2	125-200	120/240	
		QPPH		2	125-200	120/240	
		EQ968#		2	150-200	120/240	
		HQJ2 (3P)		QP,BQ,BL	1	15-70	120/240
			2		15-125	120/240	
			3		15-100	240	
			QPH,BQH,BLH	1	15-70	120/240	
				2	15-125	120/240	
				3	15-100	240	
			QT	1,2	15-50	120/240	
			QPF,BQF,BLF	1	15-30	120	

Series Rating	Main Breaker		Branch Breaker			
	Max. Amps	Type	Type	Poles	Amps	Volts
65,000	225	HQJ2 (3P)	QPF,BLF	2	15-60	120/240
			QE,BE,BLE	1	15-30	120
			QE,BLE	2	15-60	120/240
				1	15-30	120
			QPHF,BLHF	2	15-60	120/240
			QEH,BLEH	1	15-30	120
				2	15-60	120/240
			QPF2,BLF2	1	15-30	120
			QPHF2,BLHF2	1	15-30	120
			QAF,BQAF,BAF	1	15-20	120
			QAF,BAF	2	15-20	120/240
			QAFH,BQAFH	1	15-20	120
			QAFH,BAFH	2	15-20	120/240
			BAFH	1	15-20	120
			QAF2,BAF2	1	15-20	120
			QAFH2,BAFH2	1	15-20	120
			QFGA2,BFGA2	1	15-20	120
			QFGAH2,BFGAH2	1	15-20	120
				1	15-70	120/240
				2	15-125	120/240
				2	15-125	240
				1	15-70	120
				2	15-125	120/240
				2	15-125	240
			QT	1,2	15-50	120/240
			QPF,BQF,BLF	1	15-30	120
			QPF,BLF	2	15-60	120/240
			QE,BE,BLE	1	15-30	120
			QE,BLE	2	15-60	120/240
			QPHF,BQHF	1	15-30	120
	QPHF,BLHF	2	15-60	120/240		
	BLHF	1	15-30	120		
	QEH,BLEH	1	15-30	120		
		2	15-60	120/240		
	QPF2,BLF2	1	15-30	120		
	QPHF2,BLHF2	1	15-30	120		
	QAF,BQAF,BAF	1	15-20	120		
	QAF,BAF	2	15-20	120/240		
	QAFH,BQAFH	1	15-20	120		
	QAFH,BAFH	2	15-20	120/240		
	BAFH	1	15-20	120		
	QAF2,BAF2	1	15-20	120		
	QAFH2,BAFH2	1	15-20	120		
	QFGA2,BFGA2	1	15-20	120		
	QFGAH2,BFGAH2	1	15-20	120		
	QR2,QRH2	2	100-250	240		
	HQR2 (2, 3P)	QP,BQ,BL	3	15-100	240	
			QPH,BQH,BLH	3	15-100	240
			QR2,QRH2	3	100-250	240
	NFGA,NFGB (2, 3P)	QPH,BQH,BLH	1	15-70	120/240	
			2	15-125	120/240	
	NFGA,NFGB (3P)	QPH,BQH,BLH	3	15-100	240	
	FD6-A,FXD6-A (2, 3P)	QP,BQ,BL	1	15-70	120/240	
			2	15-125	120/240	
		QPH	1	15-70	120/240	
			2	15-125	120/240	
		BQH,BLH	1	15-70	120/240	
			2	15-125	120/240	
		QPPH	2	125-225	120/240	
		QJ2	2	60-225	240	
	QJH2	2	60-225	240		
	QJ2H	2	60-225	240		

5 MOLDED CASE CIRCUIT BREAKERS

Molded Case Circuit Breakers

Series Connected Short Circuit Ratings

General

240V Series Ratings (Continued)

240V Series Ratings (Continued)

Series Rating	Main Breaker		Branch Breaker				
	Max. Amps	Type	Type	Poles	Amps	Volts	
250	FD6-A,FXD6-A (2, 3P)		QR2,QRH2	2	100-250	240	
			QP,BQ,BL	1	15-70	120/240	
				2	15-125	120/240	
			QPH	1	15-70	120/240	
				2	15-125	120/240	
			BQH,BLH	1	15-70	120/240	
				2	15-125	120/240	
			QPPH	2	125-225	120/240	
			QJ2	2	60-225	240	
			QJH2	2	60-225	240	
			QJ2H	2	60-225	240	
			FD6-A,FXD6-A (3P)	QP,BQ,BL	3	15-100	240
				QPH	3	15-100	240
				BQH,BLH	3	15-100	240
				QJ2	3	60-225	240
	QJH2	3		60-225	240		
	QJ2H	3		60-225	240		
	QR2,QRH2	3		100-250	240		
	QP,BQ,BL	3		15-100	240		
	QPH	3		15-100	240		
	BQH,BLH	3		15-100	240		
	65,000	NJGA,NJJA (2, 3P)		QPH,BQH,BLH	1	15-70	120/240
				2	15-125	120/240	
				QN,QNH	2	150-200	120/240
				QNR,QNRH	2	150-200	120/240
NJGA,NJJA (3P)			QPH,BQH,BLH	3	15-100	240	
			QR2,QRH2	3	100-250	240	
JXD2-A (2, 3P)			QPH	1	15-70	120/240	
			2	15-125	120/240		
			BQH,BLH	1	15-70	120/240	
			2	15-125	120/240		
			QN,QNH	2	150-200	120/240	
			QNR,QNRH	2	150-200	120/240	
			QJH2	2	60-225	240	
			QJ2H	2	60-225	240	
			QR2,QRH2	2	100-250	240	
	JXD2-A (3P)			QPH	3	15-100	240
BQH,BLH		3		15-100	240		
QJH2		3		60-225	240		
QJ2H		3		60-225	240		
JXD2 (2, 3P)				QPH	1	15-70	120/240
	2		15-125	120/240			
	BQH,BLH		1	15-70	120/240		
	2		15-125	120/240			
	QN,QNH		2	150-200	120/240		
	QNR,QNRH		2	150-200	120/240		
	QJH2		2	60-225	240		
	QJ2H		2	60-225	240		
JXD2 (3P)		QR2,QRH2	3	100-250	240		
		QPH	3	15-100	240		
		BQH,BLH	3	15-100	240		
		QJH2	3	60-225	240		
		QJ2H	3	60-225	240		
400	JD6-A,JXD6-A (2, 3P)		QPH	1	15-70	120/240	
			2	15-125	120/240		
			BQH,BLH	1	15-70	120/240	
			2	15-125	120/240		
			QN,QNH	2	150-200	120/240	
			QNR,QNRH	2	150-200	120/240	

Series Rating	Main Breaker		Branch Breaker					
	Max. Amps	Type	Type	Poles	Amps	Volts		
400	65,000	JD6-A,JXD6-A (2, 3P)	QJH2	2	60-225	240		
			QJ2H	2	60-225	240		
			QR2,QRH2	2	100-250	240		
			QPH	3	15-100	240		
			BQH,BLH	3	15-100	240		
			QJH2	3	60-225	240		
		JD6-A,JXD6-A (3P)	QJ2H	3	60-225	240		
			QR2,QRH2	3	100-250	240		
			JD6,JXD6 (2, 3P)	QPH	1	15-70	120/240	
				2	15-125	120/240		
				BQH,BLH	1	15-70	120/240	
				2	15-125	120/240		
		JD6,JXD6 (3P)	QN,QNH	2	150-200	120/240		
			QNR,QNRH	2	150-200	120/240		
			QJH2	2	60-225	240		
	SJD6-A (3P)		QPH	3	15-100	240		
		BQH,BLH	3	15-100	240			
		QJH2	3	60-225	240			
		QJ2H	3	60-225	240			
		SJD6 (3P)	QPH	1	15-70	120/240		
			2	15-125	120/240			
	3		15-100	240				
	BQH,BLH		1	15-70	120/240			
	2		15-125	120/240				
	3		15-100	240				
	600	NJGA,NJJA (2, 3P)		QPH	1	15-70	120/240	
				2	15-125	120/240		
				3	15-100	240		
				BQH,BLH	1	15-70	120/240	
				2	15-125	120/240		
				3	15-100	240		
	600	SJD6 (3P)		QPH	1	15-70	120/240	
				2	15-125	120/240		
				3	15-100	240		
				BQH,BLH	1	15-70	120/240	
2				15-125	120/240			
3				15-100	240			
600	HJD6-A (2, 3P)		QPH	1	15-70	120/240		
			2	15-125	120/240			
			QR2,QRH2	2	100-250	240		
			HJD6-A (3P)	QPH	3	15-100	240	
				HJXD6-A (2, 3P)	QPH	1	15-70	120/240
					2	15-125	120/240	
HJXD6-A (3P)	QPH	3	15-100		240			
	QR2,QRH2	3	100-250	240				
	QPH	3	15-100	240				
600	NLGA (2, 3P)		QPH,BQH,BLH	1	15-70	120/240		
			2	15-125	120/240			
			QN,QNH	2	150-200	120/240		
			QNR,QNRH	2	150-200	120/240		
			QR2,QRH2	2	100-250	240		
			QPH,BQH,BLH	1	15-70	120/240		
			2	15-125	120/240			
			QN,QNH	2	150-200	120/240		
			QNR,QNRH	2	150-200	120/240		
			QR2,QRH2	2	100-250	240		
			NLGA (3P)	QPH,BQH,BLH	3	15-100	240	
				QR2,QRH2	3	100-250	240	
				LD6-A (2, 3P)	QPH	1	15-70	120/240
			2		15-125	120/240		
			BQH,BLH		1	15-70	120/240	
2	15-125	120/240						
QN,QNH	2	150-200	120/240					
QNR,QNRH	2	150-200	120/240					
600	LD6-A (2, 3P)		QJH2	2	60-225	240		
			QJ2H	2	60-225	240		
			QR2,QRH2	2	100-250	240		

5 MOLDED CASE CIRCUIT BREAKERS

Molded Case Circuit Breakers

Series Connected Short Circuit Ratings

General

240V Series Ratings (Continued)

Series Rating	Main Breaker		Branch Breaker				
	Max. Amps	Type	Type	Poles	Amps	Volts	
65,000	600	LD6-A (3P)	QPH	3	15-100	240	
			BQH,BLH	3	15-100	240	
			QJH2	3	60-225	240	
			QJ2H	3	60-225	240	
		LD6 (2, 3P)	QPH	1	15-70	120/240	
				2	15-125	120/240	
			BQH,BLH	1	15-70	120/240	
				2	15-125	120/240	
			QN,QNH	2	150-200	120/240	
			QNR,QNRH	2	150-200	120/240	
			QJH2	2	60-225	240	
			QJ2H	2	60-225	240	
		LD6 (3P)	QPH	3	15-100	240	
			BQH,BLH	3	15-100	240	
			QJH2	3	60-225	240	
			QJ2H	3	60-225	240	
		LXD6-A (2, 3P)	QPH	1	15-70	120/240	
				2	15-125	120/240	
			BQH,BLH	1	15-70	120/240	
				2	15-125	120/240	
			QN,QNH	2	150-200	120/240	
			QNR,QNRH	2	150-200	120/240	
			QJH2	2	60-225	240	
			QJ2H	2	60-225	240	
		LXD6-A (3P)	QPH	3	15-100	240	
				BQH,BLH	3	15-100	240
				QJH2	3	60-225	240
				QJ2H	3	60-225	240
			QR2,QRH2	3	100-250	240	
				1	15-70	120/240	
				2	15-125	120/240	
				1	15-70	120/240	
		LXD6 (2, 3P)	QN,QNH	2	150-200	120/240	
				2	150-200	120/240	
			QJH2	2	60-225	240	
				2	60-225	240	
		LXD6 (3P)	QPH	3	15-100	240	
				BQH,BLH	3	15-100	240
			QJH2	3	60-225	240	
				3	60-225	240	
		SLD6-A (3P)	QPH	1	15-70	120/240	
				2	15-125	120/240	
				3	15-100	240	
			BQH,BLH	1	15-70	120/240	
				2	15-125	120/240	
				3	15-100	240	
			QR2,QRH2	2	100-250	240	
				3	100-250	240	
		SLD6 (3P)	QPH	1	15-70	120/240	
				2	15-125	120/240	
				3	15-100	240	
			BQH,BLH	1	15-70	120/240	
				3	15-100	240	
		HLD6-A (2, 3P)	QPH	1	15-70	120/240	
				2	15-125	120/240	
			QR2,QRH2	2	100-250	240	
				3	100-250	240	
		HLD6-A (3P)	QPH	3	15-100	240	
			QR2,QRH2	3	100-250	240	
		HLD6 (2, 3P)	QPH	1	15-70	120/240	
				2	15-125	120/240	

240V Series Ratings (Continued)

Series Rating	Main Breaker		Branch Breaker				
	Max. Amps	Type	Type	Poles	Amps	Volts	
65,000	800	HLD6 (3P)	QPH	3	15-100	240	
				1	15-70	120/240	
			HLXD6-A (2, 3P)	QPH	2	15-125	120/240
					2	100-250	240
			HLXD6 (2, 3P)	QPH	1	15-70	120/240
					2	15-125	120/240
		HLXD6-A (3P)	QPH	3	15-100	240	
				3	100-250	240	
		HLXD6 (2, 3P)	QPH	1	15-70	120/240	
				2	15-125	120/240	
		HLXD6 (3P)	QPH	3	15-100	240	
				3	15-100	240	
		LMD6,LMXD6 (2, 3P)	QPH,BQH,BLH	1	15-70	120/240	
				2	15-125	120/240	
			QPH,BQH,BLH	2	15-125	120/240	
				2	15-125	120/240	
			LMD6,LMXD6 (3P)	QPH,BQH,BLH	3	15-100	240
					3	15-100	240
			HLMD6,HLMXD6 (2, 3P)	QPH,BQH,BLH	1	15-70	120/240
					2	15-125	120/240
			HLMD6,HLMXD6 (3P)	QPH,BQH,BLH	3	15-100	240
					3	15-100	240
			NMG,HMG (2, 3P)	QPH,BQH,BLH	1	15-70	120/240
					2	15-125	120/240
		QN,QNH		2	150-200	120/240	
				2	150-200	120/240	
		QR2,QRH2		2	100-250	240	
				2	100-250	240	
		NMG,HMG (3P)	QPH,BQH,BLH	3	15-100	240	
				3	100-250	240	
		MD6,MXD6 (2, 3P)	QPH	1	15-70	120/240	
				2	15-125	120/240	
			BQH,BLH	1	15-70	120/240	
				2	15-125	120/240	
			QN,QNH	2	150-200	120/240	
				2	150-200	120/240	
			QR2,QRH2	2	100-250	240	
				2	100-250	240	
		MD6,MXD6 (3P)	QPH	3	15-100	240	
				3	15-100	240	
		SMD6 (3P)	QPH	1	15-70	120/240	
				2	15-125	120/240	
				3	15-100	240	
			BQH,BLH	1	15-70	120/240	
				2	15-125	120/240	
				3	15-100	240	
			QR2,QRH2	2	100-250	240	
				3	100-250	240	
				3	100-250	240	
			HMD6,HMXD6 (2, 3P)	QPH	1	15-70	120/240
					2	15-125	120/240
			QR2,QRH2	2	100-250	240	
		2		100-250	240		
		HMD6,HMXD6 (3P)	QPH	3	15-100	240	
				3	15-100	240	
		QR2,QRH2	3	100-250	240		
			3	100-250	240		
		NNG,HNG (2, 3P)	QPH,BQH,BLH	1	15-70	120/240	
				2	15-125	120/240	
			QN,QNH	2	150-200	120/240	
				2	150-200	120/240	
			QR2,QRH2	2	100-250	240	
				2	100-250	240	
			NNG,HNG (3P)	QPH,BQH,BLH	3	15-100	240
					3	100-250	240
			ND6,NXD6 (2, 3P)	QPH	1	15-70	120/240
					2	15-125	120/240
				BQH,BLH	1	15-70	120/240
					2	15-125	120/240
		QN,QNH		2	150-200	120/240	
				2	150-200	120/240	
		QNR,QNRH		2	150-200	120/240	
				2	150-200	120/240	

5 MOLDED CASE CIRCUIT BREAKERS

Molded Case Circuit Breakers

Series Connected Short Circuit Ratings

General

240V Series Ratings (Continued)

240V Series Ratings (Continued)

Series Rating	Main Breaker		Branch Breaker				
	Max. Amps	Type	Type	Poles	Amps	Volts	
65,000	1200	ND6,NXD6 (2, 3P)	QR2,QRH2	2	100-250	240	
			QPH	3	15-100	240	
		ND6,NXD6 (3P)	BQH,BLH	3	15-100	240	
			QR2,QRH2	3	100-250	240	
			QPH	1	15-70	120/240	
		SND6 (3P)	QPH	2	15-125	120/240	
				3	15-100	240	
				BQH,BLH	1	15-70	120/240
			BQH,BLH	2	15-125	120/240	
				3	15-100	240	
				QR2,QRH2	2	100-250	240
		HND6,HNXD6 (2, 3P)	QPH	1	15-70	120/240	
	2			15-125	120/240		
	HND6,HNXD6 (3P)	QPH	3	15-100	240		
			QR2,QRH2	3	100-250	240	
	1600	NPG,HPG (3P)	QPH,BQH,BLH	1	15-70	120/240	
				2	15-125	120/240	
				3	15-100	240	
			QN,QNH	2	150-200	120/240	
				QNR,QNRH	2	150-200	120/240
				QR2,QRH2	2	100-250	240
		PD6,PXD6 (3P)	QPH	1	15-70	120/240	
				2	15-125	120/240	
				3	15-100	240	
			BQH,BLH	1	15-70	120/240	
				2	15-125	120/240	
				3	15-100	240	
		SPD6 (3P)	QN,QNH	2	150-200	120/240	
				QNR,QNRH	2	150-200	120/240
				QR2,QRH2	2	100-250	240
			QR2,QRH2	3	100-250	240	
				QPH	1	15-70	120/240
					2	15-125	120/240
3	15-100	240					
HPD6,HPXD6 (3P)	QPH	1	15-70	120/240			
		2	15-125	120/240			
	QR2,QRH2	3	15-100	240			
		2	100-250	240			
2000	RD6,RXD6 (3P)	QPH	1	15-70	120/240		
			2	15-125	120/240		
			3	15-100	240		
		BQH,BLH	1	15-70	120/240		
			2	15-125	120/240		
			3	15-100	240		
	HRD6,HRXD6 (3P)	QN,QNH	2	150-200	120/240		
			QNR,QNRH	2	150-200	120/240	
			QR2,QRH2	2	100-250	240	
		QR2,QRH2	3	100-250	240		
			QPH	1	15-70	120/240	
				2	15-125	120/240	
3	15-100	240					
QR2,QRH2	2	100-250	240				
	3	100-250	240				
100,000	100	HED4 (1P)	ED2	1	15-100	120	

Series Rating	Main Breaker		Branch Breaker					
	Max. Amps	Type	Type	Poles	Amps	Volts		
100,000	100	HED4 (1P)	ED4	1	15-100	120		
			QPBO,BL	1	15-70	120		
				2	15-125	120/240		
			QPH	1	15-70	120		
				2	15-125	120/240		
			BQH,BLH	1	15-70	120		
				2	15-125	120/240		
			HQP	1	15-70	120		
				2	15-125	120/240		
			HBO,HBL	1	15-70	120		
				2	15-125	120/240		
			QPF,BLF	1	15-60	120/240		
				2	15-60	120/240		
			NGB,HGB,LGB (2, 3P)	NGB,HGB,LGB (2, 3P)	QPBO,BL	3	15-100	240
						QPH	3	15-100
					BQH,BLH	3	15-100	240
						HQP	3	15-100
					HBO,HBL	3	15-100	240
	QPF,BQF,BLF	1				15-30	120	
	125	NGB,HGB,LGB (1, 2, 3P)	QPHF,BQHF	1	15-30	120		
				BLHF	1	15-30	120	
			QPF2,BLF2	1	15-30	120		
				QPHF2,BLHF2	1	15-30	120	
			HQP	1	15-30	120		
				2	15-30	120		
			QAF,BQAF,BAF	1	15-20	120		
				QAFH,BOAFH	1	15-20	120	
			BAFH	1	15-20	120		
				QAF2,BAF2	1	15-20	120	
			QAFH2,BAFH2	1	15-20	120		
				HOAF2,HBAF2	1	15-20	120	
			QFGA2,BFGA2	1	15-20	120		
				QFGAH2,BFGAH2	1	15-20	120	
			HOFGA2,HBFGA2	1	15-20	120		
				QPBO,BL	1	15-70	120	
			2		15-125	120/240		
				QPH	1	15-70	120	
	2	15-125	120/240					
		BQH,BLH	1	15-70	120			
	2		15-125	120/240				
		HQP	1	15-70	120			
	2		15-125	120/240				
		HBO,HBL	1	15-70	120			
	2		15-125	120/240				
		QT	1	15-50	120			
	1,2		15-50	120/240				
		QPF,BQF,BLF	1	15-30	120			
	QPF,BLF		2	15-60	120/240			
		QE,BE,BLE	1	15-30	120			
	QE,BLE		2	15-60	120/240			
		QPHF,BQHF	1	15-30	120			
	2		15-60	120/240				
		BLHF	1	15-30	120			
	QE,H,BLEH		1	15-30	120			
2		15-60	120/240					
	QPF2,BLF2	1	15-30	120				
QPHF2,BLHF2		1	15-30	120				
	HQP	1	15-30	120				
QAF,BQAF,BAF		1	15-20	120				
	QAFH,BOAFH	1	15-20	240				
BAFH		1	15-20	120				
	QAF2,BAF2	1	15-20	120				
QAFH2,BAFH2		1	15-20	240				
	HOAF2,HBAF2	1	15-20	240				
HED4,HED6 (2, 3P)		HED4,HED6 (2, 3P)	HED4,HED6 (2, 3P)	1	15-100	120		

Molded Case Circuit Breakers

Series Connected Short Circuit Ratings

General

240V Series Ratings (Continued)

240V Series Ratings (Continued)

Series Rating	Main Breaker		Branch Breaker				
	Max. Amps	Type	Type	Poles	Amps	Volts	
100,000	125	HED4,HED6 (2, 3P)	QFGA2,BFGA2	1	15-20	120	
			QFGAH2,BFGAH2	1	15-20	120	
			HQFGA2,HBFGA2	1	15-20	120	
			ED2	1	15-100	120	
			ED4	1	15-100	120	
			ED4,ED6	2	15-125	240	
		HED4,HED6 (3P)	QPBO,BL	3	15-100	240	
			QPH	3	15-100	240	
			BQH,BLH	3	15-100	240	
			HQP	3	15-100	240	
			HBQ,HBL	3	15-100	240	
			ED2	3	15-100	240	
		150	HDGA (2, 3P)	ED4,ED6	1	15-100	240
				NDGA,NDGB	2	50-150	240
			HDGA (3P)	ED4,ED6	3	15-125	240
				NDGA,NDGB	3	50-150	240
		225	HQP2H (2P)	QPBO,BL	1	15-70	120/240
					2	15-125	120/240
	QPH			1	15-70	120/240	
				2	15-125	120/240	
	BQH,BLH			1	15-70	120/240	
				2	15-125	120/240	
	HQP			1	15-70	120/240	
				2	15-125	120/240	
	HBQ,HBL			1	15-70	120/240	
				2	15-125	120/240	
	QT			1,2	15-50	120/240	
	QPF,BQF,BLF			1	15-30	120	
	QPF,BLF			2	15-60	120/240	
	QE,BE,BLE			1	15-30	120	
	QE,BLE			2	15-60	120/240	
	QPHF,BQHF			1	15-30	120	
	QPHF,BLHF			2	15-60	120/240	
	BLHF			1	15-30	120	
	QEH,BLEH			1	15-30	120	
				2	15-60	120/240	
	QPF2,BLF2			1	15-30	120	
	QPHF2,BLHF2			1	15-30	120	
	HQPF2,HBLF2			1	15-30	120	
	QAF,BQAF,BAF			1	15-20	120	
	QAFH,BQAFH			1	15-20	120	
	BAFH			1	15-20	120	
	QAF2,BAF2			1	15-20	120	
	QAFH2,BAFH2			1	15-20	120	
	HQAF2,HBAF2			1	15-20	120	
	QFGA2,BFGA2			1	15-20	120	
	QFGAH2,BFGAH2			1	15-20	120	
	HQFGA2,HBFGA2			1	15-20	120	
	QPP			2	125-225	120/240	
	EQ948#			2	125-225	120/240	
	QPPH			2	125-225	120/240	
	EQ968#			2	125-225	120/240	
	HQPP			2	125-225	120/240	
	EQ978#			2	125-225	120/240	
	EQ988# (2P)			QPBO,BL	1	15-70	120/240
					2	15-125	120/240
				QPH	1	15-70	120/240
					2	15-125	120/240
		BQH,BLH	1	15-70	120/240		
			2	15-125	120/240		

Series Rating	Main Breaker		Branch Breaker					
	Max. Amps	Type	Type	Poles	Amps	Volts		
100,000	225	EQ988# (2P)	HQP	1	15-70	120/240		
				2	15-125	120/240		
			HBQ,HBL	1	15-70	120/240		
				2	15-125	120/240		
			QT	1,2	15-50	120/240		
			QPF,BQF,BLF	1	15-30	120		
			QPF,BLF	2	15-60	120/240		
			QE,BE,BLE	1	15-30	120		
			QE,BLE	2	15-60	120/240		
			QPHF,BQHF	1	15-30	120		
				2	15-60	120/240		
			BLHF	1	15-30	120		
			QEH,BLEH	1	15-30	120		
				2	15-60	120/240		
			QPF2,BLF2	1	15-30	120		
			QPHF2,BLHF2	1	15-30	120		
			HQPF2,HBLF2	1	15-30	120		
			QAF,BQAF,BAF	1	15-20	120		
			QAFH,BQAFH	1	15-20	120		
			BAFH	1	15-20	120		
			QAF2,BAF2	1	15-20	120		
			QAFH2,BAFH2	1	15-20	120		
			HQAF2,HBAF2	1	15-20	120		
			QFGA2,BFGA2	1	15-20	120		
			QFGAH2,BFGAH2	1	15-20	120		
			HQFGA2,HBFGA2	1	15-20	120		
			QPP	2	125-225	120/240		
			EQ948#	2	125-225	120/240		
			QPPH	2	125-225	120/240		
			EQ968#	2	125-225	120/240		
			HQPP	2	125-225	120/240		
			EQ978#	2	125-225	120/240		
			HQP2H (2, 3P)	QPBO,BL	1	15-25	120/240	
						1	35-70	120/240
						2	15-25	120/240
						2	35-125	120/240
					QPH,BQH,BLH	1	15-70	120/240
						2	15-125	120/240
				HQP,HBQ,HBL	1	15-70	120/240	
					2	15-125	120/240	
				QT	1	15-50	120/240	
					1	15-50	120/240	
	QPF,BQF,BLF	1		15-30	120			
		2		15-60	120/240			
	QPF,BLF	1		15-30	120			
		2		15-60	120/240			
	QE,BE,BLE	1		15-30	120			
		2		15-60	120/240			
	QPHF,BQHF	1		15-30	120			
		2		15-60	120/240			
	BLHF	1	15-30	120				
		1	15-30	120				
	QEH,BLEH	1	15-30	120				
		2	15-60	120/240				
	QPF2,BLF2	1	15-30	120				
		1	15-30	120				
	QPHF2,BLHF2	1	15-30	120				
		1	15-30	120				
	HQP2H (2, 3P)	QAF,BQAF,BAF	1	15-20	120			
			1	15-20	120			
	QAFH,BQAFH	1	15-20	120				
		1	15-20	120				
	BAFH	1	15-20	120				
		1	15-20	120				
	QAF2,BAF2	1	15-20	120				
		1	15-20	120				
	QAFH2,BAFH2	1	15-20	120				
		1	15-20	120				
	HQAF2,HBAF2	1	15-20	120				
		1	15-20	120				
	QFGA2,BFGA2	1	15-20	120				
		1	15-20	120				
	QFGAH2,BFGAH2	1	15-20	120				
		1	15-20	120				
	HQFGA2,HBFGA2	1	15-20	120				
		1	15-20	120				

5 MOLDED CASE CIRCUIT BREAKERS

Molded Case Circuit Breakers

Series Connected Short Circuit Ratings

General

240V Series Ratings (Continued)

240V Series Ratings (Continued)

Series Rating	Main Breaker		Branch Breaker				
	Max. Amps	Type	Type	Poles	Amps	Volts	
100,000	225	HQJ2H (3P)	QP,BQ,BL	3	15-100	240	
			QPH,BQH,BLH	3	15-100	240	
			HQP,HBQ,HBL	3	15-100	240	
	250	HQR2H (2, 3P)	QP,BQ,BL	1	15-70	120/240	
				2	15-125	120/240	
			QPH,BQH,BLH	1	15-70	120/240	
				2	15-125	120/240	
			HQP,HBQ,HBL	1	15-70	120/240	
				2	15-125	240	
			QT	1,2	15-50	120/240	
			QPF,BQF,BLF	1	15-30	120	
			QPF,BLF	2	15-60	120/240	
			QE,BE,BLE	1	15-30	120	
			QE,BLE	2	15-60	120/240	
			QPHF,BQHf	1	15-30	120	
			QPHF,BLHF	2	15-60	120/240	
			BLHF	1	15-30	120	
			QEH,BLEH	1	15-30	120	
				2	15-60	120/240	
			QPF2,BLF2	1	15-30	120	
			QPHF2,BLHF2	1	15-30	120	
			HQPF2,HBLF2	1	15-30	120	
			QAF,BQAF,BAF	1	15-20	120	
			QAF,BAF	2	15-20	120/240	
			QAFH,BQAFH	1	15-20	120	
			QAFH,BAFH	2	15-20	120/240	
			BAFH	1	15-20	120	
			QAF2,BAF2	1	15-20	120	
			QAFH2,BAFH2	1	15-20	120	
			HQAF2,HBAF2	1	15-20	120	
			QFGA2,BFGA2	1	15-20	120	
			QFGAH2,BFGAH2	1	15-20	120	
			HQFGA2,HBFGA2	1	15-20	120	
			QR2,QRH2,HQR2	2	100-250	240	
			HQR2H (3P)	QP,BQ,BL	3	15-100	240
				QPH,BQH,BLH	3	15-100	240
				HQP,HBQ,HBL	3	15-100	240
			HFGA (2, 3P)	QR2,QRH2,HQR2	3	100-250	240
				QR2,QRH2,HQR2	2	100-250	240
				ED4,ED6	1	15-100	240
					2	15-125	240
				NDGA,NDGB	2	50-150	240
				NFGA,NFGB	2	70-250	240
				FD6-A,FXD6-A	2	70-250	240
				FD6,FXD6	2	70-250	240
	HFGA (3P)	QR2,QRH2,HQR2		3	100-250	240	
		ED4,ED6		3	15-125	240	
		NDGA,NDGB	3	50-150	240		
		NFGA,NFGB	3	70-250	240		
		FD6-A,FXD6-A	3	70-250	240		
	FD6,FXD6	3	70-250	240			
	HFGB (2, 3P)	QR2,QRH2,HQR2	2	100-250	240		
		ED4,ED6	1	15-100	240		
			2	15-125	240		
		NDGA,NDGB	2	50-150	240		
		NFGA,NFGB	2	70-250	240		
		FD6-A,FXD6-A	2	70-250	240		
	FD6,FXD6	2	70-250	240			
	HFGB (3P)	QR2,QRH2,HQR2	3	100-250	240		
		ED4,ED6	3	15-125	240		

Series Rating	Main Breaker		Branch Breaker			
	Max. Amps	Type	Type	Poles	Amps	Volts
100,000	250	HFGB (3P)	NDGA,NDGB	3	50-150	240
			NFGA,NFGB	3	70-250	240
			FD6-A,FXD6-A	3	70-250	240
			FD6,FXD6	3	70-250	240
			QP,BQ,BL	1	15-70	120/240
				2	15-125	120/240
		HFDB,HFXD6 (2, 3P)	QPH	1	15-70	120/240
				2	15-125	120/240
			BQH,BLH	1	15-70	120/240
				2	15-125	120/240
			HQP	1	15-70	120/240
				2	15-125	120/240
			HBQ,HBL	1	15-70	120/240
				2	15-125	120/240
			QT	1,2	15-50	120/240
			QPF,BQF,BLF	1	15-30	120
			QPF,BLF	2	15-60	120/240
			QE,BE,BLE	1	15-30	120
			QE,BLE	2	15-60	120/240
			QPHF,BQHf	1	15-30	120
		QPHF,BLHF	2	15-60	120/240	
		BLHF	1	15-30	120	
		QEH,BLEH	1	15-30	120	
			2	15-60	120/240	
		QPF2,BLF2	1	15-30	120	
		QPHF2,BLHF2	1	15-30	120	
		HQPF2,HBLF2	1	15-30	120	
		QAF,BQAF,BAF	1	15-20	120	
		QAF,BAF	2	15-20	120/240	
		QAFH,BQAFH	1	15-20	120	
		QAFH,BAFH	1	15-20	120	
		BAFH	1	15-20	120	
		QAF2,BAF2	1	15-20	120	
		QAFH2,BAFH2	1	15-20	120	
		HQAF2,HBAF2	1	15-20	120	
		QFGA2,BFGA2	1	15-20	120	
		QFGAH2,BFGAH2	1	15-20	120	
		HQFGA2,HBFGA2	1	15-20	120	
		QPP	2	125-225	120/240	
		QPPH	2	125-225	120/240	
		HQPP	2	125-225	120/240	
		QJ2	2	60-225	240	
		QJH2	2	60-225	240	
		QJ2H	2	60-225	240	
		QR2,QRH2,HQR2	2	100-250	240	
		ED4	1	15-100	120	
		ED4,ED6	2	15-125	240	
		NDGA,NDGB	2	50-150	240	
		NFGA,NFGB	2	70-250	240	
		FD6-A,FXD6-A	2	70-250	240	
		FD6,FXD6	2	70-250	240	
		HFDB,HFXD6 (3P)	QP,BQ,BL	3	15-100	240
			QPH	3	15-100	240
			BQH,BLH	3	15-100	240
			HQP	3	15-100	240
			HBQ,HBL	3	15-100	240
			QJ2	3	60-225	240
			QJH2	3	60-225	240
			QJ2H	3	60-225	240
			QR2,QRH2,HQR2	3	100-250	240
			ED4,ED6	3	15-125	240
			NDGA,NDGB	3	50-150	240
			NFGA,NFGB	3	70-250	240
			FD6-A,FXD6-A	3	70-250	240
			FD6,FXD6	3	70-250	240

Molded Case Circuit Breakers

Series Connected Short Circuit Ratings

General

240V Series Ratings (Continued)

Series Rating	Main Breaker		Branch Breaker			
	Max. Amps	Type	Type	Poles	Amps	Volts
100,000	400	HJGA (2, 3P)	QR2,QRH2,HQR2	2	100-250	240
			ED4,ED6	1	15-100	240
			ED4,ED6	2	15-125	240
			NDGA,NDGB	2	50-150	240
			NFGA,NFGB	2	70-250	240
			FD6-A,FXD6-A	2	70-250	240
			FD6,FXD6	2	70-250	240
			NJGA,NJJA	2	200-400	240
			JD6-A,JXD6-A	2	200-400	240
			JD6,JXD6	2	200-400	240
		HJGA (3P)	QR2,QRH2,HQR2	3	100-250	240
			ED4,ED6	3	15-125	240
			NDGA,NDGB	3	50-150	240
			NFGA,NFGB	3	70-250	240
			FD6-A,FXD6-A	3	70-250	240
			FD6,FXD6	3	70-250	240
			NJGA,NJJA	3	200-400	240
			JD6-A,JXD6-A	3	200-400	240
			JD6,JXD6	3	200-400	240
			HJD6-A (2, 3P)	QR2,QRH2,HQR2	2	100-250
		ED4		1	15-100	120
		ED4,ED6		2	15-125	240
		NDGA,NDGB		2	50-150	240
		NFGA,NFGB		2	70-250	240
		FD6-A,FXD6-A		2	70-250	240
		FD6,FXD6		2	70-250	240
		NJGA,NJJA		2	200-400	240
		JXD2-A		2	200-400	240
		JD6-A,JXD6-A		2	200-400	240
		HJD6-A (3P)	QR2,QRH2,HQR2	3	100-250	240
			ED4,ED6	3	15-125	240
			NDGA,NDGB	3	50-150	240
			NFGA,NFGB	3	70-250	240
			FD6-A,FXD6-A	3	70-250	240
			FD6,FXD6	3	70-250	240
			NJGA,NJJA	3	200-400	240
			JXD2-A	3	200-400	240
			JD6-A,JXD6-A	3	200-400	240
			SJD6-A	3	200-400	240
		HJXD6-A (2, 3P)	QR2,QRH2,HQR2	2	100-250	240
			ED4	1	15-100	120
			ED4,ED6	2	15-125	240
			NDGA,NDGB	2	50-150	240
			NFGA,NFGB	2	70-250	240
			FD6-A,FXD6-A	2	70-250	240
			FD6,FXD6	2	70-250	240
			NJGA,NJJA	2	200-400	240
			JXD2-A	2	200-400	240
			JD6-A,JXD6-A	2	200-400	240
		HJXD6-A (3P)	QR2,QRH2,HQR2	3	100-250	240
			ED4,ED6	3	15-125	240
			NDGA,NDGB	3	50-150	240
			NFGA,NFGB	3	70-250	240
			FD6-A,FXD6-A	3	70-250	240
			FD6,FXD6	3	70-250	240
			NJGA,NJJA	3	200-400	240
			JXD2-A	3	200-400	240
			JD6-A,JXD6-A	3	200-400	240
			SJD6-A	3	200-400	240
		HJD6,HJXD6 (2, 3P)	ED4	1	15-100	120
			ED4,ED6	2	15-125	240
			NDGA,NDGB	2	50-150	240
			NFGA,NFGB	2	70-250	240

240V Series Ratings (Continued)

Series Rating	Main Breaker		Branch Breaker				
	Max. Amps	Type	Type	Poles	Amps	Volts	
100,000	400	HJD6,HJXD6 (2, 3P)	FD6-A,FXD6-A	2	70-250	240	
			FD6,FXD6	2	70-250	240	
			NJGA,NJJA	2	200-400	240	
			JXD2	2	200-400	240	
			JD6,JXD6	2	200-400	240	
			HJD6,HJXD6 (3P)	ED4,ED6	3	15-125	240
				NDGA,NDGB	3	50-150	240
				NFGA,NFGB	3	70-250	240
				FD6-A,FXD6-A	3	70-250	240
				FD6,FXD6	3	70-250	240
		NJGA,NJJA		3	200-400	240	
		JXD2		3	200-400	240	
		JD6,JXD6		3	200-400	240	
		SJD6		3	200-400	240	
		SHJD6-A (3P)		QR2,QRH2,HQR2	2	100-250	240
			ED4	1	15-100	120	
			ED4,ED6	2	15-125	240	
			ED4,ED6	3	15-125	240	
			NDGA,NDGB	2	50-150	240	
			NDGA,NDGB	3	50-150	240	
			NFGA,NFGB	2	70-250	240	
			NFGA,NFGB	3	70-250	240	
			FD6-A,FXD6-A	2	70-250	240	
			FD6-A,FXD6-A	3	70-250	240	
		SHJD6 (3P)	ED4	1	15-100	120	
			ED4,ED6	2	15-125	240	
			ED4,ED6	3	15-125	240	
			NDGA,NDGB	2	50-150	240	
			NDGA,NDGB	3	50-150	240	
			NFGA,NFGB	2	70-250	240	
			NFGA,NFGB	3	70-250	240	
			FD6-A,FXD6-A	2	70-250	240	
			FD6-A,FXD6-A	3	70-250	240	
			FD6,FXD6	2	70-250	240	
		FD6,FXD6	3	70-250	240		
		HLGA (2, 3P)	QR2,QRH2,HQR2	2	100-250	240	
			ED4,ED6	1	15-100	120	
			ED4,ED6	2	15-125	240	
			NDGA,NDGB	2	50-150	240	
			NDGA,NDGB	2	50-150	240	
			NFGA,NFGB	2	70-250	240	
			NFGA,NFGB	2	70-250	240	
			FD6-A,FXD6-A	2	70-250	240	
			FD6-A,FXD6-A	2	70-250	240	
			FD6,FXD6	2	70-250	240	

5 MOLDED CASE CIRCUIT BREAKERS

Molded Case Circuit Breakers

Series Connected Short Circuit Ratings

General

240V Series Ratings (Continued)

240V Series Ratings (Continued)

Series Rating	Main Breaker		Branch Breaker				
	Max. Amps	Type	Type	Poles	Amps	Volts	
100,000	600	HLGA (2, 3P)	NLGA,NLGB	2	400-600	240	
			LD6,LD6-A	2	200-600	240	
			LXD6-A,LXD6	2	450-600	240	
		HLGA (3P)	QR2,QRH2,HQR2	3	100-250	240	
			ED4,ED6	3	15-125	240	
			NDGA,NDGB	3	50-150	240	
			NFGA,NFGB	3	70-250	240	
			FD6-A,FXD6-A	3	70-250	240	
			FD6,FXD6	3	70-250	240	
			NJGA,NJJA	3	200-400	240	
				3	200-400	240	
			JD6-A,JXD6-A	3	200-400	240	
			JD6,JXD6	3	200-400	240	
			NLGA,NLGB	3	400-600	240	
			LD6,LD6-A	3	200-600	240	
			LXD6-A,LXD6	3	450-600	240	
			HLGB (2, 3P)	QR2,QRH2,HQR2	2	100-250	240
				ED4,ED6	1	15-100	240
		ED4,ED6		2	15-125	240	
		NDGA,NDGB		2	50-150	240	
		NFGA,NFGB		2	70-250	240	
		FD6-A,FXD6-A		2	70-250	240	
		FD6,FXD6		2	70-250	240	
		NJGA,NJJA		2	200-400	240	
				2	200-400	240	
		JD6-A,JXD6-A		2	200-400	240	
		JD6,JXD6		2	200-400	240	
		NLGA,NLGB		2	400-600	240	
		LD6,LD6-A		2	200-600	240	
		LXD6-A,LXD6		2	450-600	240	
		HLGB (3P)		QR2,QRH2,HQR2	3	100-250	240
			ED4,ED6	3	15-125	240	
			NDGA,NDGB	3	50-150	240	
			NFGA,NFGB	3	70-250	240	
			FD6-A,FXD6-A	3	70-250	240	
			FD6,FXD6	3	70-250	240	
			NJGA,NJJA	3	200-400	240	
				3	200-400	240	
			JD6-A,JXD6-A	3	200-400	240	
			JD6,JXD6	3	200-400	240	
			NLGA,NLGB	3	400-600	240	
			LD6,LD6-A	3	200-600	240	
			LXD6-A,LXD6	3	450-600	240	
			HLD6-A (2, 3P)	QR2,QRH2,HQR2	2	100-250	240
				ED4	1	15-100	120
		ED4,ED6		2	15-125	240	
		NDGA,NDGB		2	50-150	240	
		NFGA,NFGB		2	70-250	240	
		FD6-A,FXD6-A		2	70-250	240	
		FD6,FXD6		2	70-250	240	
		NJGA,NJJA		2	200-400	240	
		JXD2		2	200-400	240	
		JD6-A,JXD6-A		2	200-400	240	
		NLGA,NLGB		2	400-600	240	
		LD6-A		2	200-600	240	
		LXD6-A		2	450-600	240	
		HLD6-A (3P)		ED4,ED6	3	15-125	240
				NDGA,NDGB	3	50-150	240
			NFGA,NFGB	3	70-250	240	
			FD6-A,FXD6-A	3	70-250	240	
			FD6,FXD6	3	70-250	240	
			NJGA,NJJA	3	200-400	240	
			JXD2-A	3	200-400	240	
				3	200-400	240	
				3	200-400	240	

Series Rating	Main Breaker		Branch Breaker				
	Max. Amps	Type	Type	Poles	Amps	Volts	
100,000	600	HLD6-A (3P)	JD6-A,JXD6-A	3	200-400	240	
			SJD6-A	3	200-400	240	
			NLGA,NLGB	3	400-600	240	
			LD6-A	3	200-600	240	
			LXD6-A	3	450-600	240	
			SLD6-A	3	300-600	240	
			ED4	1	15-100	120	
			ED4,ED6	2	15-125	240	
			NDGA,NDGB	2	50-150	240	
		HLD6 (2, 3P)	NFGA,NFGB	2	70-250	240	
			FD6-A,FXD6-A	2	70-250	240	
			FD6,FXD6	2	70-250	240	
			NJGA,NJJA	2	200-400	240	
			JXD2	2	200-400	240	
			JD6,JXD6	2	200-400	240	
			NLGA,NLGB	2	400-600	240	
			LD6	2	200-600	240	
			LXD6	2	450-600	240	
		HLD6 (3P)	ED4,ED6	3	15-125	240	
			NDGA,NDGB	3	50-150	240	
			NFGA,NFGB	3	70-250	240	
			FD6-A,FXD6-A	3	70-250	240	
			FD6,FXD6	3	70-250	240	
			NJGA,NJJA	3	200-400	240	
			JXD2	3	200-400	240	
			JD6,JXD6	3	200-400	240	
			SJD6	3	200-400	240	
			NLGA,NLGB	3	400-600	240	
			LD6	3	200-600	240	
			LXD6	3	450-600	240	
			SLD6	3	300-600	240	
			HLXD6-A (2, 3P)	QR2,QRH2,HQR2	2	100-250	240
				ED4	1	15-100	120
		ED4,ED6		2	15-125	240	
		NDGA,NDGB		2	50-150	240	
		NFGA,NFGB		2	70-250	240	
		FD6-A,FXD6-A		2	70-250	240	
		FD6,FXD6		2	70-250	240	
		NJGA,NJJA		2	200-400	240	
		JXD2-A		2	200-400	240	
		JD6-A,JXD6-A		2	200-400	240	
		NLGA,NLGB		2	400-600	240	
		LD6-A		2	200-600	240	
		LXD6-A		2	450-600	240	
		HLXD6-A (3P)		QR2,QRH2,HQR2	3	100-250	240
				ED4,ED6	3	15-125	240
			NDGA,NDGB	3	50-150	240	
			NFGA,NFGB	3	70-250	240	
			FD6-A,FXD6-A	3	70-250	240	
			FD6,FXD6	3	70-250	240	
			NJGA,NJJA	3	200-400	240	
			JXD2-A	3	200-400	240	
			JD6-A,JXD6-A	3	200-400	240	
		HLXD6 (2, 3P)	SJD6-A	3	200-400	240	
			NLGA,NLGB	3	400-600	240	
			LD6-A	3	200-600	240	
			LXD6-A	3	450-600	240	
			ED4	1	15-100	120	
			ED4,ED6	2	15-125	240	
			NDGA,NDGB	2	50-150	240	
			NFGA,NFGB	2	70-250	240	
			FD6-A,FXD6-A	2	70-250	240	
		FD6,FXD6	2	70-250	240		

Molded Case Circuit Breakers

Series Connected Short Circuit Ratings

General

240V Series Ratings (Continued)

240V Series Ratings (Continued)

Series Rating	Main Breaker		Branch Breaker				
	Max. Amps	Type	Type	Poles	Amps	Volts	
100,000	600	HLXD6 (2, 3P)	NJGA,NJJA	2	200-400	240	
			JXD2	2	200-400	240	
			JD6,JXD6	2	200-400	240	
			NLGA,NLGB	2	400-600	240	
			LD6	2	200-600	240	
		LXD6	2	450-600	240		
		HLXD6 (3P)	ED4,ED6	3	15-125	240	
			NDGA,NDGB	3	50-150	240	
			NFGA,NFGB	3	70-250	240	
			FD6-A,FXD6-A	3	70-250	240	
			FD6,FXD6	3	70-250	240	
			NJGA,NJJA	3	200-400	240	
			JXD2	3	200-400	240	
			JD6,JXD6	3	200-400	240	
			SJD6	3	200-400	240	
			NLGA,NLGB	3	400-600	240	
			LD6	3	200-600	240	
			LXD6	3	450-600	240	
			SLD6	3	300-600	240	
			SHLD6-A (3P)	QR2,QRH2,HQR2	2	100-250	240
					3	100-250	240
		ED4		1	15-100	120	
		ED4,ED6		2	15-125	240	
				3	15-125	240	
		NDGA,NDGB		2	50-150	240	
				3	50-150	240	
		NFGA,NFGB		2	70-250	240	
				3	70-250	240	
		FD6-A,FXD6-A		2	70-250	240	
				3	70-250	240	
		FD6,FXD6		2	70-250	240	
				3	70-250	240	
		NJGA,NJJA		2	200-400	240	
				3	200-400	240	
		JXD2-A		2	200-400	240	
				3	200-400	240	
		JD6-A,JXD6-A		2	200-400	240	
				3	200-400	240	
		SJD6-A		3	200-400	240	
		NLGA,NLGB	2	400-600	240		
			3	400-600	240		
		LD6-A	2	200-600	240		
			3	200-600	240		
			2	450-600	240		
			3	450-600	240		
		SLD6-A	3	300-600	240		
		SHLD6 (3P)	ED4	1	15-100	120	
			ED4,ED6	2	15-125	240	
				3	15-125	240	
			NDGA,NDGB	2	50-150	240	
	3		50-150	240			
NFGA,NFGB	2		70-250	240			
	3		70-250	240			
FD6,FXD6	2		70-250	240			
	3		70-250	240			
NJGA,NJJA	2		200-400	240			
	3		200-400	240			
JXD2	2		200-400	240			
	3		200-400	240			
JD6,JXD6	2		200-400	240			
	3		200-400	240			
SJD6	3	200-400	240				

Series Rating	Main Breaker		Branch Breaker			
	Max. Amps	Type	Type	Poles	Amps	Volts
100,000	600	SHLD6 (3P)	NLGA,NLGB	2	400-600	240
				3	400-600	240
			LD6	2	200-600	240
				3	200-600	240
			LXD6	2	450-600	240
			3	450-600	240	
		SLD6	3	300-600	240	
		HMG (2, 3P)	QR2,QRH2,HQR2	2	100-250	240
				3	100-250	240
			ED4,ED6	1	15-100	120
				2	15-125	240
				3	15-125	240
			NDGA,NDGB	2	50-150	240
				3	50-150	240
			NFGA,NFGB	2	70-250	240
				3	70-250	240
			FD6-A,FXD6-A	2	70-250	240
				3	70-250	240
			FD6,FXD6	2	70-250	240
				3	70-250	240
			NJGA,NJJA	2	200-400	240
				3	200-400	240
			JD6-A,JXD6-A	2	200-400	240
				3	200-400	240
			JD6,JXD6	2	200-400	240
				3	200-400	240
			NLGA,NLGB	2	400-600	240
			3	400-600	240	
		LD6,LD6-A	2	200-600	240	
			3	200-600	240	
		LXD6-A,LXD6	2	450-600	240	
			3	450-600	240	
		LMD6,LMXD6	2	600-800	240	
		NMG	2	600-800	240	
		MD6,MXD6	2	400-800	240	
		HMG (3P)	QR2,QRH2,HQR2	3	100-250	240
			ED4,ED6	3	15-125	240
			NDGA,NDGB	3	50-150	240
			NFGA,NFGB	3	70-250	240
			FD6-A,FXD6-A	3	70-250	240
			FD6,FXD6	3	70-250	240
			NJGA,NJJA	3	200-400	240
			JD6-A,JXD6-A	3	200-400	240
			JD6,JXD6	3	200-400	240
			NLGA,NLGB	3	400-600	240
			LD6,LD6-A	3	200-600	240
			LXD6-A,LXD6	3	450-600	240
			LMD6,LMXD6	3	600-800	240
			NMG	3	600-800	240
			MD6,MXD6	3	400-800	240
HMD6,HMXD6 (2, 3P)	QR2,QRH2,HQR2	2	100-250	240		
		3	100-250	240		
	ED4	1	15-100	120		
	ED4,ED6	2	15-125	240		
		3	15-125	240		
	NDGA,NDGB	2	50-150	240		
		3	50-150	240		
	NFGA,NFGB	2	70-250	240		
		3	70-250	240		
	FD6-A,FXD6-A	2	70-250	240		
		3	70-250	240		
	FD6,FXD6	2	70-250	240		
		3	70-250	240		
	NJGA,NJJA	2	200-400	240		
		3	200-400	240		
	JXD2-A	2	200-400	240		
		3	200-400	240		
	JD6-A,JXD6-A	2	200-400	240		
		3	200-400	240		
	JD6,JXD6	2	200-400	240		
	3	200-400	240			
NLGA,NLGB	2	400-600	240			
LD6-A	2	200-600	240			
LD6	2	200-600	240			
LXD6-A	2	450-600	240			
LXD6	2	450-600	240			
NMG	2	500-800	240			
MD6,MXD6	2	500-800	240			
HMD6,HMXD6 (3P)	QR2,QRH2,HQR2	3	100-250	240		
	ED4,ED6	3	15-125	240		
	NDGA,NDGB	3	50-150	240		
	NFGA,NFGB	3	70-250	240		
	FD6-A,FXD6-A	3	70-250	240		
FD6,FXD6	3	70-250	240			

5 MOLDED CASE CIRCUIT BREAKERS

Molded Case Circuit Breakers

Series Connected Short Circuit Ratings

General

240V Series Ratings (Continued)

240V Series Ratings (Continued)

Series Rating	Main Breaker		Branch Breaker				
	Max. Amps	Type	Type	Poles	Amps	Volts	
100,000	1200	HND6,HNXD6 (3P)	LD6-A	3	200-600	240	
			LD6	3	200-600	240	
			LXD6-A	3	450-600	240	
			LXD6	3	450-600	240	
			SLD6-A	3	300-600	240	
			SLD6	3	300-600	240	
			NMG	3	500-800	240	
			MD6,MXD6	3	500-800	240	
			SMD6	3	500-800	240	
			NNG	3	800-1200	240	
			ND6,NXD6	3	500-1200	240	
			SND6	3	500-1200	240	
			QR2,QRH2,HQR2	2	100-250	240	
			ED4	1	15-100	240	
			ED4,ED6	2	15-125	240	
			ED4,ED6	3	15-125	240	
			NDGA,NDGB	2	50-150	240	
			NDGA,NDGB	3	50-150	240	
			NFGA,NFGB	2	70-250	240	
			NFGA,NFGB	3	70-250	240	
		FD6-A,FXD6-A	2	70-250	240		
		FD6-A,FXD6-A	3	70-250	240		
		FD6,FXD6	2	70-250	240		
		FD6,FXD6	3	70-250	240		
		NJGA,NJJA	2	200-400	240		
		NJGA,NJJA	3	200-400	240		
		JXD2-A	2	200-400	240		
		JXD2-A	3	200-400	240		
		JXD2	2	200-400	240		
		JXD2	3	200-400	240		
		JD6-A,JXD6-A	2	200-400	240		
		JD6-A,JXD6-A	3	200-400	240		
		JD6,JXD6	2	200-400	240		
		JD6,JXD6	3	200-400	240		
		SHND6 (3P)	SJD6-A	3	200-400	240	
			SJD6	3	200-400	240	
			NLGA,NLGB	2	400-600	240	
			NLGA,NLGB	3	400-600	240	
			LD6-A	2	200-600	240	
			LD6-A	3	200-600	240	
			LD6	2	200-600	240	
			LD6	3	200-600	240	
			LXD6-A	2	450-600	240	
			LXD6-A	3	450-600	240	
			LXD6	2	450-600	240	
			LXD6	3	450-600	240	
			SLD6-A	3	300-600	240	
			SLD6	3	200-600	240	
			NMG	2	500-800	240	
			NMG	3	500-800	240	
	MD6,MXD6		2	500-800	240		
	MD6,MXD6		3	500-800	240		
	SMD6		3	500-800	240		
	NNG		2	800-1200	240		
	NNG		3	800-1200	240		
	ND6,NXD6		2	500-1200	240		
	ND6,NXD6		3	500-1200	240		
	SND6		3	500-1200	240		
	1600		HPG (3P)	QR2,QRH2,HQR2	2	100-250	240
				QR2,QRH2,HQR2	3	100-250	240
				ED4,ED6	1	15-100	240
				ED4,ED6	2	15-125	240
				ED4,ED6	3	15-125	240

Series Rating	Main Breaker		Branch Breaker				
	Max. Amps	Type	Type	Poles	Amps	Volts	
100,000	1600	HPG (3P)	NDGA,NDGB	2	50-150	240	
			NDGA,NDGB	3	50-150	240	
			NFGA,NFGB	2	70-250	240	
			NFGA,NFGB	3	70-250	240	
			FD6-A,FXD6-A	2	70-250	240	
			FD6-A,FXD6-A	3	70-250	240	
			FD6,FXD6	2	70-250	240	
			FD6,FXD6	3	70-250	240	
			NJGA,NJJA	2	200-400	240	
			NJGA,NJJA	3	200-400	240	
			JD6-A,JXD6-A	2	200-400	240	
			JD6-A,JXD6-A	3	200-400	240	
			JD6,JXD6	2	200-400	240	
			JD6,JXD6	3	200-400	240	
			NLGA,NLGB	2	400-600	240	
			NLGA,NLGB	3	400-600	240	
			LD6,LD6-A	2	200-600	240	
			LD6,LD6-A	3	200-600	240	
			LXD6-A,LXD6	2	450-600	240	
			LXD6-A,LXD6	3	450-600	240	
			LMD6,LMXD6	2	600-800	240	
			LMD6,LMXD6	3	600-800	240	
			NMG	2	600-800	240	
			NMG	3	600-800	240	
			MD6,MXD6	2	400-800	240	
			MD6,MXD6	3	400-800	240	
			NNG	2	800-1200	240	
			NNG	3	800-1200	240	
			ND6,NXD6	2	600-1200	240	
			ND6,NXD6	3	600-1200	240	
			NPG	2	1200-1600	240	
			NPG	3	1200-1600	240	
			PD6,PXD6	2	1200-1600	240	
			PD6,PXD6	3	1200-1600	240	
			HPD6,HPXD6 (3P)	QR2,QRH2,HQR2	2	100-250	240
				QR2,QRH2,HQR2	3	100-250	240
				ED4	1	15-100	120
				ED4,ED6	2	15-125	240
				ED4,ED6	3	15-125	240
				NDGA,NDGB	2	50-150	240
				NDGA,NDGB	3	50-150	240
				NFGA,NFGB	2	70-250	240
				NFGA,NFGB	3	70-250	240
				FXD6-A,FD6-A	2	70-250	240
				FXD6-A,FD6-A	3	70-250	240
				FXD6,FD6	2	70-250	240
				FXD6,FD6	3	70-250	240
				NJGA,NJJA	2	200-400	240
				NJGA,NJJA	3	200-400	240
				JXD2-A	2	200-400	240
	JXD2-A	3		200-400	240		
	JXD2	2		200-400	240		
	JXD2	3		200-400	240		
	JXD6-A,JD6-A	2		200-400	240		
	JXD6-A,JD6-A	3		200-400	240		
	JXD6,JD6	2		200-400	240		
	JXD6,JD6	3		200-400	240		
	SJD6-A	3		200-400	240		
	SJD6	3		200-400	240		
	NLGA,NLGB	2		400-600	240		
	NLGA,NLGB	3		400-600	240		
	LD6-A	2		200-600	240		
	LD6-A	3		200-600	240		

Molded Case Circuit Breakers

Series Connected Short Circuit Ratings

General

240V Series Ratings (Continued)

240V Series Ratings (Continued)

Series Rating	Main Breaker		Branch Breaker					
	Max. Amps	Type	Type	Poles	Amps	Volts		
100,000	1600	HPD6,HPXD6 (3P)	LD6	2	200-600	240		
				3	200-600	240		
			LXD6-A	2	450-600	240		
				3	450-600	240		
			LXD6	2	450-600	240		
				3	450-600	240		
			SLD6-A	3	300-600	240		
			SLD6	3	300-600	240		
			NMG	2	600-800	240		
				3	600-800	240		
			MD6,MXD6	2	500-800	240		
				3	500-800	240		
			SMD6	3	500-800	240		
			NNG	2	800-1200	240		
				3	800-1200	240		
			ND6,NXD6	2	500-1200	240		
				3	500-1200	240		
			SND6	3	500-1200	240		
			NPG	2	1200-1600	240		
				3	1200-1600	240		
			PD6,PXD6	2	1200-1600	240		
				3	1200-1600	240		
			SPD6	3	1400-1600	240		
				SHPD6 (3P)	QR2,QRH2,HQR2	2	100-250	240
					3	100-250	240	
			ED4		1	15-100	120	
			ED4,ED6		2	15-125	240	
		3	15-125		240			
	NDGA,NDGB	2	50-150		240			
		3	50-150		240			
	NFGA,NFGB	2	70-250		240			
		3	70-250		240			
	FXD6-A,FD6-A	2	70-250		240			
		3	70-250		240			
	FXD6,FD6	2	70-250		240			
		3	70-250		240			
	NJGA,NJJA	2	200-400		240			
		3	200-400		240			
	JXD2-A	2	200-400		240			
		3	200-400		240			
	JXD2	2	200-400		240			
		3	200-400		240			
	JXD6-A,JD6-A	2	200-400		240			
		3	200-400		240			
	JXD6,JD6	2	200-400		240			
		3	200-400		240			
	SJD6-A	3	200-400		240			
	SJD6	3	200-400		240			
	NLGA,NLGB	2	400-600		240			
		3	400-600		240			
	LD6-A	2	200-600	240				
		3	200-600	240				
	LD6	2	200-600	240				
		3	200-600	240				
LXD6-A	2	450-600	240					
	3	450-600	240					
LXD6	2	450-600	240					
	3	450-600	240					
SLD6-A	3	300-600	240					
SLD6	3	300-600	240					
NMG	2	600-800	240					
	3	600-800	240					
MD6,MXD6	2	500-800	240					
	3	500-800	240					

Series Rating	Main Breaker		Branch Breaker					
	Max. Amps	Type	Type	Poles	Amps	Volts		
100,000	1600	SHPD6 (3P)	SMD6	3	500-800	240		
			NNG	2	800-1200	240		
				3	800-1200	240		
			ND6,NXD6	2	500-1200	240		
				3	500-1200	240		
			SND6	3	500-1200	240		
			NPG	2	1200-1600	240		
				3	1200-1600	240		
			PD6,PXD6	2	1200-1600	240		
				3	1200-1600	240		
			SPD6	3	1400-1600	240		
				HRD6,HRXD6 (3P)	QR2,QRH2,HQR2	2	100-250	240
					3	100-250	240	
			ED4		1	15-100	120	
			ED4,ED6		2	15-125	240	
					3	15-125	240	
			NDGA,NDGB		2	50-150	240	
					3	50-150	240	
	NFGA,NFGB	2	70-250		240			
		3	70-250		240			
	FXD6-A,FD6-A	2	70-250		240			
		3	70-250		240			
	FXD6,FD6	2	70-250		240			
		3	70-250		240			
	NJGA,NJJA	2	200-400		240			
		3	200-400		240			
	JXD2-A	2	200-400		240			
		3	200-400		240			
	JXD2	2	200-400		240			
		3	200-400		240			
	JXD6-A,JD6-A	2	200-400		240			
		3	200-400		240			
	JXD6,JD6	2	200-400		240			
		3	200-400		240			
	SJD6-A	3	200-400		240			
	SJD6	3	200-400		240			
	NLGA,NLGB	2	400-600		240			
		3	400-600		240			
	LD6-A	2	200-600		240			
		3	200-600		240			
	LD6	2	200-600		240			
		3	200-600		240			
	LXD6-A	2	450-600		240			
		3	450-600		240			
	LXD6	2	450-600		240			
		3	450-600		240			
	SLD6-A	3	300-600		240			
	SLD6	3	300-600	240				
	NMG	2	600-800	240				
		3	600-800	240				
	MD6,MXD6	2	500-800	240				
		3	500-800	240				
	SMD6	3	500-800	240				
	NNG	2	800-1200	240				
	3	800-1200	240					
ND6,NXD6	2	500-1200	240					
	3	500-1200	240					
SND6	3	500-1200	240					
NPG	2	1200-1600	240					
	3	1200-1600	240					
PD6,PXD6	2	1200-1600	240					
	3	1200-1600	240					
SPD6	3	1400-1600	240					
RD6,RXD6	2	1600-2000	240					
	3	1600-2000	240					

Molded Case Circuit Breakers

Series Connected Short Circuit Ratings

General

240V Series Ratings (Continued)

240V Series Ratings (Continued)

Series Rating	Main Breaker		Branch Breaker			
	Max. Amps	Type	Type	Poles	Amps	Volts
200,000	125	CED6 (2, 3P)	QP,BQ,BL	1	15-70	120/240
				2	15-125	120/240
			2	15-125	240	
			QPH	1	15-70	120/240
				2	15-125	120/240
			BQH,BLH	1	15-70	120/240
				2	15-125	120/240
			HQP	1	15-70	120/240
				2	15-125	120/240
			HBO,HBL	1	15-70	120/240
				2	15-125	120/240
			QT	1	15-50	120/240
			QT	1,2	15-50	120/240
			QPF,BQF,BLF	1	15-30	120
			QPF,BLF	2	15-60	120/240
			QE,BE,BLE	1	15-30	120
			QE,BLE	2	15-60	120/240
			QPHF,BQHF	1	15-30	120
			QPHF,BLHF	2	15-60	120/240
			BLHF	1	15-30	120
			QEH,BLEH	1	15-30	120
			QEH,BLEH	2	15-60	120/240
			QAF,BQAF,BAF	1	15-20	120
			QAFH,BQAFH	1	15-20	120
			BAFH	1	15-20	120
			QAF2,BAF2	1	15-20	120
			QAFH2,BAFH2	1	15-20	120
			HQAF2,HBAF2	1	15-20	120
			QFGA2,BFGA2	1	15-20	120
			QFGAH2,BFGAH2	1	15-20	120
		HQFGA2,HBFGA2	1	15-20	120	
		ED4	1	15-100	120	
		ED4,ED6	2	15-125	240	
		HED4	1	15-100	120	
		HED4,HED6	2	15-125	240	
		CED6 (3P)	QP,BQ,BL	3	15-100	240
			QPH	3	15-100	240
			BQH,BLH	3	15-100	240
			HQP	3	15-100	240
			HBO,HBL	3	15-100	240
			ED4,ED6	3	15-125	240
			HED4,HED6	3	15-125	240
		150	LDGA (2, 3P)	1	15-125	120
				2	15-125	240
				2	50-150	240
			LDGA (3P)	1	15-125	240
				3	50-150	240
				3	50-150	240
			LDGB (2, 3P)	1	15-125	120
				2	15-125	240
2	50-150			240		
LDGB (3P)	1		15-125	240		
	3		50-150	240		
	3		50-150	240		
250	LFGA (2, 3P)	1	15-125	120		
		2	15-125	240		
		2	50-150	240		
		2	50-150	240		
		2	70-250	240		
		2	70-250	240		
		2	70-250	240		
		2	70-250	240		
		2	70-250	240		
		2	70-250	240		

Series Rating	Main Breaker		Branch Breaker				
	Max. Amps	Type	Type	Poles	Amps	Volts	
200,000	250	LFGB (2, 3P)	LFGB (3P)	1	15-125	120	
				2	15-125	240	
				2	50-150	240	
				2	50-150	240	
				2	70-250	240	
			LFGB (2, 3P)	1	15-125	120	
				2	15-125	240	
				2	50-150	240	
				2	50-150	240	
				2	70-250	240	
		LFGB (3P)	1	15-125	240		
			3	15-125	240		
			3	50-150	240		
			3	50-150	240		
			3	70-250	240		
		CFD6(-A) (2, 3P)	LFGB (3P)	QP,BQ,BL	1	15-70	120/240
				2	15-125	120/240	
				1	15-70	120/240	
				2	15-125	120/240	
				1	15-70	120/240	
				2	15-125	120/240	
				1	15-70	120/240	
				2	15-125	120/240	
				1	15-70	120/240	
				2	15-125	120/240	
			CFD6(-A) (2, 3P)	QPH	1	15-70	120/240
				2	15-125	120/240	
				BQH,BLH	1	15-70	120/240
				2	15-125	120/240	
				HQP	1	15-70	120/240
				2	15-125	120/240	
				HBO,HBL	1	15-70	120/240
				2	15-125	120/240	
				QP,BQ,BL	3	15-100	240
				QPH	3	15-100	240
		CFD6(-A) (2, 3P)	BQH,BLH	3	15-100	240	
			HQP	3	15-100	240	
			HBO,HBL	3	15-100	240	
			QT	1,2	15-50	120/240	
			QPF,BQF,BLF	1	15-30	120	
			QPF,BLF	2	15-60	120/240	
			QE,BE,BLE	1	15-30	120	
			QE,BLE	2	15-60	120/240	
			QPHF,BQHF	1	15-30	120	
			QPHF,BLHF	2	15-60	120/240	
		CFD6(-A) (2, 3P)	BLHF	1	15-30	120	
			QEH,BLEH	1	15-30	120	
			2	15-60	120/240		
			QAF,BQAF,BAF	1	15-20	120	
			QAFH,BQAFH	1	15-20	120	
BAFH	1		15-20	120			
QAF2,BAF2	1		15-20	120			
QAFH2,BAFH2	1		15-20	120			
HQAF2,HBAF2	1		15-20	120			
QFGA2,BFGA2	1		15-20	120			
CFD6(-A) (2, 3P)	QFGAH2,BFGAH2	1	15-20	120			
	HQFGA2,HBFGA2	1	15-20	120			
	QPP	2	125-225	120/240			
	QPPH	2	125-225	120/240			
	QJ2	2	60-225	240			
	QJH2	2	60-225	240			
	QJ2H	2	60-225	240			
	ED2	1	15-100	120			
	ED2	2	15-100	240			
	ED4	1	15-100	120			
CFD6(-A) (2, 3P)	ED4,ED6	2	15-125	240			
	HED4	1	15-100	120			
	HED4,HED6	2	15-125	240			
	NDGB,HDGB	2	50-150	240			
	NDGA,HDGA	2	50-150	240			

5 MOLDED CASE CIRCUIT BREAKERS

Molded Case Circuit Breakers

Series Connected Short Circuit Ratings

General

240V Series Ratings (Continued)

240V Series Ratings (Continued)

Series Rating	Main Breaker		Branch Breaker			
	Max. Amps	Type	Type	Poles	Amps	Volts
200,000	250	CFD6(-A) (2, 3P)	NFGA,HFGA	2	70-250	240
			NFGB,HFGB	2	70-250	240
			FXD6-A,FD6-A	2	70-250	240
			FXD6,FD6	2	70-250	240
			HFD6,HFXD6	2	70-250	240
		CFD6(-A) (3P)	QPBO,BL	3	15-100	240
			QPH	3	15-100	240
			BQH,BLH	3	15-100	240
			HQP	3	15-100	240
			HBO,HBL	3	15-100	240
			QJ2	3	60-225	240
			QJH2	3	60-225	240
			QJ2H	3	60-225	240
			ED2	3	15-100	240
			ED4,ED6	3	15-125	240
			HED4,HED6	3	15-125	240
	400	LJGA (2, 3P)	NGB,HGB,LGB	1	15-125	120
				2	15-125	240
			NDGB,HDGB	2	50-150	240
			NDGA,HDGA	2	50-150	240
			NFGA,HFGA	2	70-250	240
			NFGB,HFGB	2	70-250	240
			HFD6,HFXD6	2	70-250	240
			NJGA,NJJA	2	200-400	240
		HJGA	2	200-400	240	
		LJGA (3P)	NGB,HGB,LGB	3	15-125	240
			NDGB,HDGB	3	50-150	240
			NDGA,HDGA	3	50-150	240
			NFGA,HFGA	3	70-250	240
			NFGB,HFGB	3	70-250	240
			HFD6,HFXD6	3	70-250	240
	NJGA,NJJA		3	200-400	240	
HJGA	3	200-400	240			
HHJD6 (2, 3P)	NDGB,HDGB	2	50-150	240		
	NDGA,HDGA	2	50-150	240		
	NFGA,HFGA	2	70-250	240		
	NFGB,HFGB	2	70-250	240		
	FXD6-A,FD6-A	2	70-250	240		
	FXD6,FD6	2	70-250	240		
	HFXD6,HFD6	2	70-250	240		
	NJGA,NJJA	2	200-400	240		
	HJGA	2	200-400	240		
	HHJD6 (3P)	NDGB,HDGB	3	50-150	240	
NDGA,HDGA		3	50-150	240		
NFGA,HFGA		3	70-250	240		
NFGB,HFGB		3	70-250	240		
FXD6-A,FD6-A		3	70-250	240		
FXD6,FD6		3	70-250	240		
HFXD6,HFD6		3	70-250	240		
NJGA,NJJA		3	200-400	240		
HJGA		3	200-400	240		
HHJXD6(2, 3P)		NDGB,HDGB	2	50-150	240	
	NDGA,HDGA	2	50-150	240		
	NFGA,HFGA	2	70-250	240		
	NFGB,HFGB	2	70-250	240		
	FXD6-A,FD6-A	2	70-250	240		

Series Rating	Main Breaker		Branch Breaker			
	Max. Amps	Type	Type	Poles	Amps	Volts
200,000	400	HHJXD6(2, 3P)	FXD6,FD6	2	70-250	240
			HFXD6,HFD6	2	70-250	240
			NJGA,NJJA	2	200-400	240
			HJGA	2	200-400	240
		HHJXD6 (3P)	NDGB,HDGB	3	50-150	240
			NDGA,HDGA	3	50-150	240
			NFGA,HFGA	3	70-250	240
			NFGB,HFGB	3	70-250	240
			FXD6-A,FD6-A	3	70-250	240
			FXD6,FD6	3	70-250	240
			HFXD6,HFD6	3	70-250	240
			NJGA,NJJA	3	200-400	240
			HJGA	3	200-400	240
			CJD6(-A) (2, 3P)	QPH	2	100-125
		BQH,BLH		2	100-125	120/240
		HQP		2	100-125	120/240
		HBO,HBL		2	100-125	120/240
		QT		1,2	15-30	120/240
		ED4,ED6		2	15-125	240
		NDGB,HDGB		2	50-150	240
		NDGA,HDGA		2	50-150	240
		NFGA,HFGA		2	70-250	240
		NFGB,HFGB		2	70-250	240
	CJD6(-A) (3P)	FXD6-A,FD6-A	2	70-250	240	
		FXD6,FD6	2	70-250	240	
		HFD6,HFXD6	2	70-250	240	
		NJGA,NJJA	2	200-400	240	
		HJGA	2	200-400	240	
		JXD2-A	2	200-400	240	
		JXD2	2	200-400	240	
		JD6-A,JXD6-A	2	200-400	240	
		JD6,JXD6	2	200-400	240	
		HJD6-A	2	200-400	240	
		HJXD6-A	2	200-400	240	
		HJD6,HJXD6	2	200-400	240	
		CJD6(-A) (3P)	QPH	3	100	240
			BQH,BLH	3	100	240
			HQP	3	100	240
			HBO,HBL	3	100	240
			ED4,ED6	3	15-125	240
			NDGB,HDGB	3	50-150	240
	NDGA,HDGA		3	50-150	240	
	NFGA,HFGA		3	70-250	240	
	NFGB,HFGB		3	70-250	240	
	FXD6-A,FD6-A		3	70-250	240	
	FXD6,FD6		3	70-250	240	
	HFD6,HFXD6		3	70-250	240	
	NJGA,NJJA		3	200-400	240	
	HJGA		3	200-400	240	
	CJD6(-A),CJD6-A (2, 3P)	JXD2-A	3	200-400	240	
		JXD2	3	200-400	240	
JD6-A,JXD6-A		3	200-400	240		
JD6,JXD6		3	200-400	240		
HJD6-A		3	200-400	240		
HJXD6-A		3	200-400	240		
CJD6(-A),CJD6-A (3P)	HJD6,HJXD6	3	200-400	240		
	NGB,HGB,LGB	1	15-125	120		
600	LLGA (2, 3P)	NGB,HGB,LGB	2	15-125	240	
		NDGB,HDGB	2	50-150	240	
		NDGA,HDGA	2	50-150	240	

Molded Case Circuit Breakers

Series Connected Short Circuit Ratings

General

240V Series Ratings (Continued)

240V Series Ratings (Continued)

Series Rating	Main Breaker		Branch Breaker			
	Max. Amps	Type	Type	Poles	Amps	Volts
200,000	600	LLGA (2, 3P)	NFGA,HFGA	2	70-250	240
			NFGB,HFGB	2	70-250	240
			HFD6,HFXD6	2	70-250	240
			NJGA,NJJA	2	200-400	240
			HJGA	2	200-400	240
			NLGA,HLGA	2	400-600	240
			NLGB,HLGB	2	400-600	240
		LLGA (3P)	NGB,HGB,LGB	3	15-125	240
			NDGB,HDGB	3	50-150	240
			NDGA,HDGA	3	50-150	240
			NFGA,HFGA	3	70-250	240
			NFGB,HFGB	3	70-250	240
			HFD6,HFXD6	3	70-250	240
			NJGA,NJJA	3	200-400	240
			HJGA	3	200-400	240
		LLGB (2, 3P)	NLGA,HLGA	3	400-600	240
			NLGB,HLGB	3	400-600	240
			NGB,HGB,LGB	1	15-125	120
				2	15-125	240
			NDGB,HDGB	2	50-150	240
			NDGA,HDGA	2	50-150	240
			NFGA,HFGA	2	70-250	240
			NFGB,HFGB	2	70-250	240
			HFD6,HFXD6	2	70-250	240
			NJGA,NJJA	2	200-400	240
		LLGB (3P)	HJGA	2	200-400	240
			NLGA,HLGA	2	400-600	240
			NLGB,HLGB	2	400-600	240
			NGB,HGB,LGB	3	15-125	240
			NDGB,HDGB	3	50-150	240
			NDGA,HDGA	3	50-150	240
			NFGA,HFGA	3	70-250	240
			NFGB,HFGB	3	70-250	240
			HFD6,HFXD6	3	70-250	240
			NJGA,NJJA	3	200-400	240
		HHLd6 (2, 3P)	HJGA	3	200-400	240
			NLGA,HLGA	3	400-600	240
			NLGB,HLGB	3	400-600	240
			NDGB,HDGB	2	50-150	240
			NDGA,HDGA	2	50-150	240
			NFGA,HFGA	2	70-250	240
			NFGB,HFGB	2	70-250	240
			FXD6-A,FD6-A	2	70-250	240
			FXD6,FD6	2	70-250	240
			HFXD6,HFD6	2	70-250	240
		HHLd6 (3P)	NJGA,NJJA	2	200-400	240
			HJGA	2	200-400	240
			NLGA,HLGA	2	400-600	240
			NLGB,HLGB	2	400-600	240
			NDGB,HDGB	3	50-150	240
			NDGA,HDGA	3	50-150	240
			NFGA,HFGA	3	70-250	240
			NFGB,HFGB	3	70-250	240
			FXD6-A,FD6-A	3	70-250	240
			FXD6,FD6	3	70-250	240
		HHLXD6 (2, 3P)	HFXD6,HFD6	3	70-250	240
			NJGA,NJJA	3	200-400	240
			HJGA	3	200-400	240
			NLGA,HLGA	3	400-600	240
			NLGB,HLGB	3	400-600	240
			NDGB,HDGB	2	50-150	240
			NDGA,HDGA	2	50-150	240
		NFGA,HFGA	2	70-250	240	

Series Rating	Main Breaker		Branch Breaker				
	Max. Amps	Type	Type	Poles	Amps	Volts	
200,000	600	HHLXD6 (2, 3P)	NFGB,HFGB	2	70-250	240	
			FXD6-A,FD6-A	2	70-250	240	
			FXD6,FD6	2	70-250	240	
			HFXD6,HFD6	2	70-250	240	
			NJGA,NJJA	2	200-400	240	
			HJGA	2	200-400	240	
			NLGA,HLGA	2	400-600	240	
			NLGB,HLGB	2	400-600	240	
			HHLXD6 (3P)	NDGB,HDGB	3	50-150	240
				NDGA,HDGA	3	50-150	240
		NFGA,HFGA		3	70-250	240	
		NFGB,HFGB		3	70-250	240	
		FXD6-A,FD6-A		3	70-250	240	
		FXD6,FD6		3	70-250	240	
		HFXD6,HFD6		3	70-250	240	
		NJGA,NJJA		3	200-400	240	
		HJGA		3	200-400	240	
		NLGA,HLGA		3	400-600	240	
		CLD6(-A) (2, 3P)	NLGB,HLGB	3	400-600	240	
			QPH	2	100-125	120/240	
			BQH,BLH	2	100-125	120/240	
			HQP	2	100-125	120/240	
			HBO,HBL	2	100-125	120/240	
			QT	1,2	15-30	120/240	
			NGB,HGB,LGB	1	15-125	120	
				2	15-125	240	
			ED4,ED6	2	15-125	240	
			NDGB,HDGB	2	50-150	240	
		CLD6(-A) (3P)	NDGA,HDGA	2	50-150	240	
			NFGA,HFGA	2	70-250	240	
			NFGB,HFGB	2	70-250	240	
			FXD6-A,FD6-A	2	70-250	240	
			FXD6,FD6	2	70-250	240	
			HFD6,HFXD6	2	70-250	240	
			NJGA,NJJA	2	200-400	240	
			HJGA	2	200-400	240	
			JXD2-A	3	200-400	240	
			JXD2	3	200-400	240	
		CLD6(-A) (3P)	JD6-A,JXD6-A	2	200-400	240	
			JD6,JXD6	2	200-400	240	
			HJD6-A	2	200-400	240	
			HJXD6-A	2	200-400	240	
			HJD6,HJXD6	2	200-400	240	
			NLGA,HLGA	2	400-600	240	
			NLGB,HLGB	2	400-600	240	
			LD6-A	2	200-600	240	
			LD6	2	200-600	240	
			LXD6-A	2	450-600	240	
		CLD6(-A) (3P)	LXD6	2	450-600	240	
			HLD6-A	2	200-600	240	
			HLD6	2	200-600	240	
			HLXD6-A	2	450-600	240	
			HLXD6	2	450-600	240	
			QPH	3	100	240	
			BQH,BLH	3	100	240	
			HQP	3	100	240	
			HBO,HBL	3	100	240	
			NGB,HGB,LGB	3	15-125	240	
		CLD6(-A) (3P)	ED4,ED6	3	15-125	240	
			NDGB,HDGB	3	50-150	240	
			NDGA,HDGA	3	50-150	240	
			NFGA,HFGA	3	70-250	240	
			NFGB,HFGB	3	70-250	240	
			NFGB,HFGB	3	70-250	240	

5 MOLDED CASE CIRCUIT BREAKERS

Molded Case Circuit Breakers

Series Connected Short Circuit Ratings

General

240V Series Ratings (Continued)

240V Series Ratings (Continued)

Series Rating	Main Breaker		Branch Breaker			
	Max. Amps	Type	Type	Poles	Amps	Volts
200,000	600	CLD6(-A) (3P)	FXD6-A,FD6-A	3	70-250	240
			FXD6,FD6	3	70-250	240
			HFD6,HFXD6	3	70-250	240
			NJGA,NJJA	3	200-400	240
			HJGA	3	200-400	240
			JXD2-A	2	200-400	240
			JXD2	2	200-400	240
			JD6-A,JXD6-A	3	200-400	240
			JD6,JXD6	3	200-400	240
			HJD6-A	3	200-400	240
			HJXD6-A	3	200-400	240
			HJD6,HJXD6	3	200-400	240
			NLGA,HLGA	3	400-600	240
			NLGB,HLGB	3	400-600	240
			LD6-A	3	200-600	240
			LD6	3	200-600	240
			LXD6-A	3	450-600	240
			LXD6	3	450-600	240
			HLD6-A	3	200-600	240
			HLD6	3	200-600	240
HLXD6-A	3	450-600	240			
HLXD6	3	450-600	240			
200,000	800	LMG (2, 3P)	NDGB,HDGB	2	50-150	240
			NDGA,HDGA	2	50-150	240
			NFGA,HFGA	2	70-250	240
			NFGB,HFGB	2	70-250	240
			HFD6,HFXD6	2	70-250	240
			NJGA,NJJA	2	200-400	240
			HJGA	2	200-400	240
			NLGA,HLGA	2	400-600	240
			NLGB,HLGB	2	400-600	240
			MD6,MXD6	2	400-800	240
		HMD6,HMXD6	2	400-800	240	
		LMG (3P)	NDGB,HDGB	3	50-150	240
			NDGA,HDGA	3	50-150	240
			NFGA,HFGA	3	70-250	240
			NFGB,HFGB	3	70-250	240
			HFD6,HFXD6	3	70-250	240
			NJGA,NJJA	3	200-400	240
			HJGA	3	200-400	240
			NLGA,HLGA	3	400-600	240
			NLGB,HLGB	3	400-600	240
MD6,MXD6	3		400-800	240		
HMD6,HMXD6	3	400-800	240			
CMD6 (2, 3P)	ED4,ED6	2	15-125	240		
	HED4,HED6	2	15-125	240		
	NDGB,HDGB	2	50-150	240		
	NDGA,HDGA	2	50-150	240		
	NFGA,HFGA	2	70-250	240		
	NFGB,HFGB	2	70-250	240		
	FXD6-A,FD6-A	2	70-250	240		
	FXD6,FD6	2	70-250	240		
	HFD6,HFXD6	2	70-250	240		
	NJGA,NJJA	2	200-400	240		
	HJGA	2	200-400	240		
	JXD2-A	2	200-400	240		
	JXD2	2	200-400	240		
	JD6-A	2	200-400	240		
	JD6	2	200-400	240		
	JXD6-A	2	200-400	240		
	JXD6	2	200-400	240		
	HJD6-A	2	200-400	240		
	HJXD6-A	2	200-400	240		

Series Rating	Main Breaker		Branch Breaker			
	Max. Amps	Type	Type	Poles	Amps	Volts
200,000	800	CMD6 (2, 3P)	HJD6,HJXD6	2	200-400	240
			NLGA,HLGA	2	400-600	240
			NLGB,HLGB	2	400-600	240
			LD6-A	2	200-600	240
			LD6	2	200-600	240
			LXD6-A	2	450-600	240
			LXD6	2	450-600	240
			HLD6-A	2	200-600	240
			HLD6	2	200-600	240
			HLXD6-A	2	450-600	240
		HLXD6	2	450-600	240	
		MD6,MXD6	2	500-800	240	
		HMD6,HMXD6	2	500-800	240	
		CMD6 (3P)	ED4,ED6	3	15-125	240
			HED4,HED6	3	15-125	240
			NDGB,HDGB	3	50-150	240
			NDGA,HDGA	3	50-150	240
			NFGA,HFGA	3	70-250	240
			NFGB,HFGB	3	70-250	240
			FXD6-A,FD6-A	3	70-250	240
FXD6,FD6	3		70-250	240		
HFD6,HFXD6	3		70-250	240		
NJGA,NJJA	3		200-400	240		
HJGA	3	200-400	240			
JXD2-A	3	200-400	240			
JXD2	3	200-400	240			
JD6-A	3	200-400	240			
JD6	3	200-400	240			
JXD6-A	3	200-400	240			
JXD6	3	200-400	240			
HJD6-A	3	200-400	240			
HJXD6-A	3	200-400	240			
SCMD6(-A) (3P)	CMD6 (3P)	HJD6-A	3	200-400	240	
		HJXD6-A	3	200-400	240	
		NLGA,HLGA	3	400-600	240	
		NLGB,HLGB	3	400-600	240	
		LD6-A	3	200-600	240	
		LD6	3	200-600	240	
		LXD6-A	3	450-600	240	
		LXD6	3	450-600	240	
		HLD6-A	3	200-600	240	
		HLD6	3	200-600	240	
	HLXD6-A	3	450-600	240		
	HLXD6	3	450-600	240		
	MD6,MXD6	3	500-800	240		
	HMD6,HMXD6	3	500-800	240		
	SCMD6(-A) (3P)	NDGB,HDGB	2	50-150	240	
		NDGA,HDGA	2	50-150	240	
		NFGA,HFGA	2	70-250	240	
		NFGB,HFGB	2	70-250	240	
		FXD6-A,FD6-A	2	70-250	240	
		FXD6,FD6	2	70-250	240	
HFD6,HFXD6		2	70-250	240		
NJGA,NJJA		2	200-400	240		
HJGA		2	200-400	240		
JXD2-A		2	200-400	240		
JXD2	2	200-400	240			
JD6-A	2	200-400	240			
JD6	2	200-400	240			
JXD6-A	2	200-400	240			
JXD6	2	200-400	240			
HJD6-A	2	200-400	240			
HJXD6-A	2	200-400	240			

Molded Case Circuit Breakers

Series Connected Short Circuit Ratings

General

240V Series Ratings (Continued)

Series Rating	Main Breaker		Branch Breaker			
	Max. Amps	Type	Type	Poles	Amps	Volts
200,000	1200	LNG (2, 3P)	NDGB,HDGB	2	50-150	240
			NDGA,HDGA	2	50-150	240
			NFGA,HFGA	2	70-250	240
			NFGB,HFGB	2	70-250	240
			HFD6,HFXD6	2	70-250	240
			NJGA,NJJA	2	200-400	240
			HJGA	2	200-400	240
			NLGA,HLGA	2	400-600	240
			NLGB,HLGB	2	400-600	240
			MD6,MXD6	2	400-800	240
			HMD6,HMXD6	2	400-800	240
			ND6,NXD6	2	600-1200	240
			HND6,HNXD6	2	600-1200	240
			LNG (3P)	NDGB,HDGB	3	50-150
		NDGA,HDGA		3	50-150	240
		NFGA,HFGA		3	70-250	240
		NFGB,HFGB		3	70-250	240
		HFD6,HFXD6		3	70-250	240
		NJGA,NJJA		3	200-400	240
		HJGA		3	200-400	240
		NLGA,HLGA		3	400-600	240
		NLGB,HLGB		3	400-600	240
		MD6,MXD6		3	400-800	240
		HMD6,HMXD6		3	400-800	240
		ND6,NXD6		3	600-1200	240
		HND6,HNXD6		3	600-1200	240
		CND6 (2, 3P)		ED4,ED6	2	15-125
			HED4,HED6	2	15-125	240
			FXD6-A,FD6-A	2	70-250	240
			FXD6,FD6	2	70-250	240
			HFD6,HFXD6	2	70-250	240
			JXD2-A	2	200-400	240
			JXD2	2	200-400	240
			JD6-A	2	200-400	240
			JD6	2	200-400	240
			JXD6-A	2	200-400	240
			JXD6	2	200-400	240
			HJD6-A	2	200-400	240
			HJXD6-A	2	200-400	240
			HJD6,HJXD6	2	200-400	240
			LD6-A	2	200-600	240
			LD6	2	200-600	240
			LXD6-A	2	450-600	240
			CND6 (3P)	LXD6	2	450-600
		HLD6-A		2	200-600	240
		HLD6		2	200-600	240
		HLXD6-A		2	450-600	240
		HLXD6		2	450-600	240
		MD6,MXD6		2	500-800	240
		HMD6,HMXD6		2	500-800	240
		ND6,NXD6		2	500-1200	240
		HND6,HNXD6		2	500-1200	240
		ED4,ED6		3	15-125	240
		HED4,HED6		3	15-125	240
		FXD6-A,FD6-A		3	70-250	240
		FXD6,FD6		3	70-250	240
		HFD6,HFXD6		3	70-250	240
		JXD2-A		3	200-400	240
		JXD2		3	200-400	240
		JD6-A		3	200-400	240
		JD6		3	200-400	240
		JXD6-A	3	200-400	240	
		JXD6	3	200-400	240	

240V Series Ratings (Continued)

Series Rating	Main Breaker		Branch Breaker				
	Max. Amps	Type	Type	Poles	Amps	Volts	
200,000	1200	CND6 (3P)	HJD6-A	3	200-400	240	
			HJXD6-A	3	200-400	240	
			HJD6,HJXD6	3	200-400	240	
			LD6-A	3	200-600	240	
			LD6	3	200-600	240	
			LXD6-A	3	450-600	240	
			LXD6	3	450-600	240	
			HLD6-A	3	200-600	240	
			HLD6	3	200-600	240	
			HLXD6-A	3	450-600	240	
			HLXD6	3	450-600	240	
			MD6,MXD6	3	500-800	240	
			HMD6,HMXD6	3	500-800	240	
			ND6,NXD6	3	500-1200	240	
			HND6,HNXD6	3	500-1200	240	
			SCND6(-A) (3P)	NDGB,HDGB	2	50-150	240
				NDGA,HDGA	2	50-150	240
				NFGA,HFGA	2	70-250	240
				NFGB,HFGB	2	70-250	240
				HFD6,HFXD6	2	70-250	240
				NJGA,NJJA	2	200-400	240
				HJGA	2	200-400	240
				NLGA,HLGA	2	400-600	240
				NLGB,HLGB	2	400-600	240
				MD6,MXD6	2	500-800	240
				SMD6	3	500-800	240
				HMD6,HMXD6	2	500-800	240
				HMD6,HMXD6	3	500-800	240
				SHMD6	3	500-800	240
				ND6,NXD6	2	500-1200	240
				ND6,NXD6	3	500-1200	240
				SND6	3	500-1200	240
				HND6,HNXD6	2	500-1200	240
				HND6,HNXD6	3	500-1200	240
		SHND6		3	500-1200	240	
		LPG (3P)		NDGB,HDGB	2	50-150	240
				NDGB,HDGB	3	50-150	240
				NDGA,HDGA	2	50-150	240
				NDGA,HDGA	3	50-150	240
				NFGA,HFGA	2	70-250	240
				NFGA,HFGA	3	70-250	240
				NFGB,HFGB	2	70-250	240
				NFGB,HFGB	3	70-250	240
				HFD6,HFXD6	2	70-250	240
				HFD6,HFXD6	3	70-250	240
				NJGA,NJJA	2	200-400	240
				NJGA,NJJA	3	200-400	240
				HJGA	2	200-400	240
				HJGA	3	200-400	240
			NLGA,HLGA	2	400-600	240	
			NLGA,HLGA	3	400-600	240	
			NLGB,HLGB	2	400-600	240	
			NLGB,HLGB	3	400-600	240	
			MD6,HMXD6	2	400-800	240	
			MD6,HMXD6	3	400-800	240	

5 MOLDED CASE CIRCUIT BREAKERS

Molded Case Circuit Breakers

Series Connected Short Circuit Ratings

General

240V Series Ratings (Continued)

240V Series Ratings (Continued)

Series Rating	Main Breaker		Branch Breaker			
	Max. Amps	Type	Type	Poles	Amps	Volts
200,000	1600	LPG (3P)	HMD6,HMXD6	2	400-800	240
				3	400-800	240
			ND6,NXD6	2	600-1200	240
				3	600-1200	240
			HND6,HNXD6	2	600-1200	240
				3	600-1200	240
			PD6,PXD6	2	1200-1600	240
				3	1200-1600	240
			HPD6,HPXD6	2	1200-1600	240
				3	1200-1600	240
			NDGB,HDGB	2	50-150	240
				3	50-150	240
			NDGA,HDGA	2	50-150	240
				3	50-150	240
		NFGA,HFGA	2	70-250	240	
			3	70-250	240	
		NFGB,HFGB	2	70-250	240	
			3	70-250	240	
		FXD6-A,FD6-A	2	70-250	240	
			3	70-250	240	
		FXD6,FD6	2	70-250	240	
			3	70-250	240	
		HFD6,HFXD6	2	70-250	240	
			3	70-250	240	
		NJGA,NJJA	2	200-400	240	
			3	200-400	240	
		HJGA	2	200-400	240	
			3	200-400	240	
		JXD2-A	2	200-400	240	
			3	200-400	240	
		JXD2	2	200-400	240	
			3	200-400	240	
		JD6-A,JXD6-A	2	200-400	240	
			3	200-400	240	
		JD6,JXD6	2	200-400	240	
			3	200-400	240	
		HJD6-A	2	200-400	240	
			3	200-400	240	
		HJXD6-A	2	200-400	240	
			3	200-400	240	
		HJD6,HJXD6	2	200-400	240	
			3	200-400	240	
		NLGA,HLGA	2	400-600	240	
			3	400-600	240	
		NLGB,HLGB	2	400-600	240	
			3	400-600	240	
		LD6-A	2	200-600	240	
			3	200-600	240	
		LD6	2	200-600	240	
			3	200-600	240	
LXD6-A	2	450-600	240			
	3	450-600	240			
LXD6	2	450-600	240			
	3	450-600	240			
HLD6-A	2	200-600	240			
	3	200-600	240			
HLD6	2	200-600	240			
	3	200-600	240			
HLXD6-A	2	450-600	240			
	3	450-600	240			
HLXD6	2	450-600	240			
	3	450-600	240			
MD6,MXD6	2	500-800	240			
	3	500-800	240			

Series Rating	Main Breaker		Branch Breaker			
	Max. Amps	Type	Type	Poles	Amps	Volts
200,000	1600	CPD6 (3P)	HMD6,HMXD6	2	500-800	240
			HMD6,HMXD6	3	500-800	240
			ND6,NXD6	2	500-1200	240
			ND6,NXD6	3	500-1200	240
			HND6,HNXD6	2	500-1200	240
			HND6,HNXD6	3	500-1200	240

Molded Case Circuit Breakers

Series Connected Short Circuit Ratings

General

480V Series Ratings

Series Rating	Main Breaker		Branch Breaker			
	Max. Amps	Type	Type	Poles	Amps	Volts
25,000	125	NGB,HGB,LGB (2,3P)	BQD,CQD	1	15-100	277
				2	15-100	277/480
30,000	125	NGB,HGB,LGB (3P)	BQD,CQD	3	15-100	277/480
35,000	250	FD6-A,FXD6-A (2,3P)	ED4	1	15-100	277
			ED4,ED6	2	15-125	480
	400	FD6-A,FXD6-A (3P)	ED4,ED6	3	15-125	480
		JD6-A,JXD6-A (2,3P)	NGB	1	15-125	277
				2	15-125	277/480
600	JD6,JXD6 (2,3P)	NGB	3	15-125	277/480	
42,000	125	HED4 (2,3P)	ED4	1	15-100	277
			ED4,ED6	2	15-125	480
	400	HED4 (3P)	ED4,ED6	3	15-125	480
		HJD6-A (2,3P)	NGB,HGB	1	15-125	277
				2	15-125	277/480
		HJD6-A (3P)	NGB,HGB	3	15-125	277/480
		HJXD6-A (2,3P)	NGB,HGB	1	15-125	277
				2	15-125	277/480
600	HJXD6-A (3P)	NGB,HGB	3	15-125	277/480	
50,000	250	HFD6,HFXD6 (2,3P)	NGB,HGB	1	15-125	277
				2	15-125	277/480
	400	HFD6,HFXD6 (3P)	NGB,HGB	3	15-125	277/480
		HJD6-A (2,3P)	HED4	2	15-50	480
		HJD6-A (3P)	HED4	3	15-50	480
	HJXD6-A (2,3P)	HED4	2	15-50	480	
	600	HJXD6-A (3P)	HED4	3	15-50	480
	HLD6-A (2,3P)	HED4	2	15-50	480	
	HLD6-A (3P)	HED4	3	15-50	480	
	HLXD6-A (2,3P)	HED4	2	15-50	480	
	HLD6,HLXD6 (2,3P)	HED4	3	15-50	480	
	HLD6,HLXD6 (3P)	HED4	3	15-50	480	
800	MD6,MXD6 (2,3P)	NDGA,NDGB	2	50-150	480	
		NFGA,NFGB	2	70-250	480	
		FXD6,FD6	2	70-250	480	
		FXD6-A,FD6-A	2	70-250	480	
		NJGA	2	250-400	480	
		JXD6,JD6	2	200-400	480	
		JXD6-A,JD6-A	2	200-400	480	
		NLGA,NLGB	2	400-600	480	
		LD6	2	200-600	480	
		LD6-A	2	200-600	480	
		LXD6	2	450-600	480	
		LXD6-A	2	450-600	480	
		SJD6-A	3	200-400	480	
		SJD6	3	200-400	480	
	MD6,MXD6 (3P)	NDGA,NDGB	3	50-150	480	
		NFGA,NFGB	3	70-250	480	
	SMD6 (3P)	NDGA,NDGB	2	50-150	480	
		NFGA,NFGB	2	70-250	480	
	NMG	NMG	2	600-800	480	
		NMG	3	600-800	480	

480V Series Ratings (Continued)

Series Rating	Main Breaker		Branch Breaker				
	Max. Amps	Type	Type	Poles	Amps	Volts	
50,000	800	MD6,MXD6 (3P)	FXD6-A,FD6-A	3	70-250	480	
			NJGA	3	250-400	480	
			JXD6,JD6	3	200-400	480	
			JXD6-A,JD6-A	3	200-400	480	
			NLGA,NLGB	3	400-600	480	
			LD6	3	200-600	480	
			LD6-A	3	200-600	480	
			LXD6	3	450-600	480	
			LXD6-A	3	450-600	480	
			SJD6-A	3	200-400	480	
			SJD6	3	200-400	480	
			SLD6-A	3	400-600	480	
			SLD6	3	400-600	480	
			LMD6,LMXD6	3	600-800	480	
			NMG	3	600-800	480	
			SMD6 (3P)	NDGA,NDGB	2	50-150	480
					3	50-150	480
				NFGA,NFGB	2	70-250	480
					3	70-250	480
				NJGA	2	250-400	480
				3	250-400	480	
		JD6,JXD6		2	200-400	480	
				3	200-400	480	
		JD6-A,JXD6-A		2	200-400	480	
				3	200-400	480	
		NLGA,NLGB		2	400-600	480	
				3	400-600	480	
		LD6-A		2	200-600	480	
				3	200-600	480	
		LD6		2	200-600	480	
				3	200-600	480	
		LXD6-A		2	450-600	480	
				3	450-600	480	
		LXD6		2	450-600	480	
				3	450-600	480	
		SJD6-A		3	200-400	480	
		SJD6		3	200-400	480	
		SLD6-A	3	400-600	480		
		SLD6	3	400-600	480		
		LMD6,LMXD6	2	600-800	480		
			3	600-800	480		
		NMG	2	600-800	480		
	3	600-800	480				
1200	ND6,NXD6 (2,3P)	NDGA,NDGB	2	50-150	480		
		NFGA,NFGB	2	70-250	480		
		FXD6,FD6	2	70-250	480		
		FXD6-A,FD6-A	2	70-250	480		
		NJGA	2	250-400	480		
		JXD6,JD6	2	200-400	480		
		JXD6-A,JD6-A	2	200-400	480		
		NLGA,NLGB	2	400-600	480		
		LD6	2	200-600	480		
		LD6-A	2	200-600	480		
		LXD6	2	450-600	480		
		LXD6-A	2	450-600	480		
		NMG	2	600-800	480		
		ND6,NXD6 (3P)	NDGA,NDGB	3	50-150	480	

Molded Case Circuit Breakers

Series Connected Short Circuit Ratings

General

480V Series Ratings (Continued)

Series Rating	Main Breaker		Branch Breaker				
	Max. Amps	Type	Type	Poles	Amps	Volts	
50,000	1200	ND6,NXD6 (3P)	NFGA,NFGB	3	70-250	480	
			FXD6,FD6	3	70-250	480	
			FXD6-A,FD6-A	3	70-250	480	
			NJGA	3	250-400	480	
			JXD6,JD6	3	200-400	480	
			JXD6-A,JD6-A	3	200-400	480	
			NLGA,NLGB	3	400-600	480	
			LD6	3	200-600	480	
			LD6-A	3	200-600	480	
			LXD6	3	450-600	480	
			LXD6-A	3	450-600	480	
			SJD6	3	200-400	480	
			SJD6-A	3	200-400	480	
			SLD6	3	400-600	480	
			SLD6-A	3	400-600	480	
			NMG	3	600-800	480	
			LMD6,LXMD6	3	600-800	480	
			SND6 (3P)	NDGA,NDGB	2	50-150	480
				NDGA,NDGB	3	50-150	480
				NFGA,NFGB	2	70-250	480
				NFGA,NFGB	3	70-250	480
		NJGA		2	250-400	480	
		NJGA		3	250-400	480	
		JD6,JXD6		2	200-400	480	
		JD6,JXD6		3	200-400	480	
		JD6-A,JXD6-A		2	200-400	480	
		JD6-A,JXD6-A		3	200-400	480	
		NLGA,NLGB		2	400-600	480	
		NLGA,NLGB		3	400-600	480	
		LD6		2	200-600	480	
		LD6		3	200-600	480	
		LD6-A		2	200-600	480	
		LD6-A		3	200-600	480	
	LXD6	2		450-600	480		
	LXD6	3		450-600	480		
	LXD6-A	2		450-600	480		
	LXD6-A	3		450-600	480		
	SJD6	3		200-400	480		
	SJD6-A	3	200-400	480			
	SLD6	3	400-600	480			
	SLD6-A	3	400-600	480			
	NMG	2	600-800	480			
	NMG	3	600-800	480			
	LMD6,LXMD6	2	600-800	480			
	LMD6,LXMD6	3	600-800	480			
	1600	PD6,PXD6 (3P)	NDGA,NDGB	2	50-150	480	
			NDGA,NDGB	3	50-150	480	
			NFGA,NFGB	2	70-250	480	
			NFGA,NFGB	3	70-250	480	
			FXD6,FD6	2	70-250	480	
			FXD6,FD6	3	70-250	480	
			FXD6-A,FD6-A	2	70-250	480	
			FXD6-A,FD6-A	3	70-250	480	
			NJGA	2	250-400	480	
NJGA			3	250-400	480		
JD6,JXD6			2	200-400	480		
JD6,JXD6			3	200-400	480		
JD6-A,JXD6-A			2	200-400	480		
JD6-A,JXD6-A			3	200-400	480		
NLGA,NLGB			2	400-600	480		
NLGA,NLGB			3	400-600	480		
LD6			2	200-600	480		
LD6			3	200-600	480		
LD6-A			2	200-600	480		
LD6-A			3	200-600	480		
LXD6			2	450-600	480		
LXD6	3	450-600	480				
LXD6-A	2	450-600	480				
LXD6-A	3	450-600	480				
SJD6	3	200-400	480				
SJD6-A	3	200-400	480				

480V Series Ratings (Continued)

Series Rating	Main Breaker		Branch Breaker				
	Max. Amps	Type	Type	Poles	Amps	Volts	
50,000	1600	PD6,PXD6 (3P)	SLD6	3	400-600	480	
			SLD6-A	3	400-600	480	
			NMG	2	600-800	480	
			NMG	3	600-800	480	
			NNG	2	800-1200	480	
			NNG	3	800-1200	480	
			NPG	2	1200-1600	480	
			NPG	3	1200-1600	480	
			SPD6 (3P)	JD6,JXD6	2	200-400	480
				JD6,JXD6	3	200-400	480
				JD6-A,JXD6-A	2	200-400	480
				JD6-A,JXD6-A	3	200-400	480
				LD6	2	200-600	480
				LD6	3	200-600	480
				LD6-A	2	200-600	480
		LD6-A		3	200-600	480	
		LXD6		2	450-600	480	
		LXD6		3	450-600	480	
		LXD6-A		2	450-600	480	
		LXD6-A		3	450-600	480	
		SJD6		3	200-400	480	
		SJD6-A		3	200-400	480	
		SLD6		3	400-600	480	
		SLD6-A	3	400-600	480		
		2000	RD6,RXD6 (3P)	NDGA,NDGB	2	50-150	480
				NDGA,NDGB	3	50-150	480
				NFGA,NFGB	2	70-250	480
				NFGA,NFGB	3	70-250	480
				FXD6,FD6	2	70-250	480
				FXD6,FD6	3	70-250	480
				FXD6-A,FD6-A	2	70-250	480
				FXD6-A,FD6-A	3	70-250	480
				NJGA	2	250-400	480
	NJGA			3	250-400	480	
	JD6-A,JXD6-A			2	200-400	480	
	JD6-A,JXD6-A			3	200-400	480	
	JD6,JXD6			2	200-400	480	
	JD6,JXD6			3	200-400	480	
	NLGA,NLGB			2	400-600	480	
	NLGA,NLGB			3	400-600	480	
	LD6-A			2	200-600	480	
	LD6-A			3	200-600	480	
	LXD6-A			2	450-600	480	
	LXD6-A			3	450-600	480	
	SJD6-A			3	200-400	480	
	SJD6	3	200-400	480			
	SLD6-A	3	400-600	480			
	SLD6	3	400-600	480			
	NMG	2	600-800	480			
	NMG	3	600-800	480			
	NNG	2	800-1200	480			
	NNG	3	800-1200	480			
	NPG	2	1200-1600	480			
	NPG	3	1200-1600	480			
65,000	150	HDGA,HDGB (2,3P)	NDGA,NDGB	2	50-150	480	
		HDGA,HDGB (3P)	NDGA,NDGB	3	50-150	480	
		HFGA,HFGB (2,3P)	NDGA,NDGB	2	50-150	480	
	250	HFGA,HFGB (2,3P)	NFGA,NFGB	2	70-250	480	
		HFGA,HFGB (3P)	NDGA,NDGB	3	50-150	480	
		HFGA,HFGB (3P)	NFGA,NFGB	3	70-250	480	
		HFD6,HFXD6 (2,3P)	ED4	1	15-100	277	
			ED4,ED6	2	15-125	480	
			HED4	1	15-100	277	
			HED4,HED6	2	15-125	480	
			NDGA,NDGB	2	50-150	480	
			NDGA,NDGB	3	50-150	480	
			NFGA,NFGB	2	70-250	480	
			NFGA,NFGB	3	70-250	480	
			NFGA,NFGB	2	70-250	480	

Molded Case Circuit Breakers

Series Connected Short Circuit Ratings

General

480V Series Ratings (Continued)

Series Rating	Main Breaker		Branch Breaker				
	Max. Amps	Type	Type	Poles	Amps	Volts	
65,000	250	HFD6,HFXD6 (3P)	ED4,ED6	3	15-125	480	
			HED4,HED6	3	15-125	480	
			NDGA,NDGB	3	50-150	480	
			NFGA,NFGB	3	70-250	480	
	HJGA (2,3P)	HJGA (2,3P)	NGB,HGB	1	15-125	277	
				2	15-125	277/480	
			NDGA,NDGB	2	50-150	480	
			NFGA,NFGB	2	70-250	480	
			NJGA	2	250-400	480	
				2	250-400	480	
	HJGA (3P)	HJGA (3P)	NGB,HGB	3	15-125	277/480	
			NDGA,NDGB	3	50-150	480	
			NFGA,NFGB	3	70-250	480	
	HJD6-A (2,3P)	HJD6-A (2,3P)	NJGA	3	250-400	480	
			ED4	1	15-100	277	
	400	HJD6-A (2,3P)	HED4	1	15-100	277	
			NDGA,NDGB	2	50-150	480	
			NFGA,NFGB	2	70-250	480	
			FD6-A,FXD6-A	2	70-250	480	
			FD6,FXD6	2	70-250	480	
			JD6-A,JXD6-A	2	200-400	480	
		HJD6-A (3P)	HJD6-A (3P)	NJGA	2	250-400	480
				JD6,JXD6	2	200-400	480
				NDGA,NDGB	3	50-150	480
				NFGA,NFGB	3	70-250	480
FD6-A,FXD6-A				3	70-250	480	
FD6,FXD6				3	70-250	480	
65,000	HJXD6-A (2,3P)	HJXD6-A (2,3P)	NJGA	3	250-400	480	
			JD6-A,JXD6-A	3	200-400	480	
			JD6,JXD6	3	200-400	480	
			ED4	1	15-100	277	
			HED4	1	15-100	277	
			NDGA,NDGB	2	50-150	480	
	HJXD6-A (3P)	HJXD6-A (3P)	NFGA,NFGB	2	70-250	480	
			FD6-A,FXD6-A	2	70-250	480	
			FD6,FXD6	2	70-250	480	
			NJGA	2	250-400	480	
			JD6-A,JXD6-A	2	200-400	480	
			JD6,JXD6	2	200-400	480	
	HJD6,HJXD6 (2,3P)	HJD6,HJXD6 (2,3P)	ED4	1	15-100	277	
			HED4	1	15-100	277	
			NDGA,NDGB	2	50-150	480	
	HJD6,HJXD6 (3P)	HJD6,HJXD6 (3P)	NFGA,NFGB	2	70-250	480	
			FD6-A,FXD6-A	2	70-250	480	
			FD6,FXD6	2	70-250	480	
600	HJXD6-A (2,3P)	HJXD6-A (2,3P)	JD6,JXD6	2	200-400	480	
			NJGA	2	250-400	480	
			JD6-A,JXD6-A	2	200-400	480	
			JD6,JXD6	2	200-400	480	
			ED4	1	15-100	277	
			HED4	1	15-100	277	
	HJXD6-A (3P)	HJXD6-A (3P)	NDGA,NDGB	3	50-150	480	
			NFGA,NFGB	3	70-250	480	
			FD6-A,FXD6-A	3	70-250	480	
			FD6,FXD6	3	70-250	480	
			NJGA	3	250-400	480	
			JD6-A,JXD6-A	3	200-400	480	
HJD6,HJXD6 (2,3P)	HJD6,HJXD6 (2,3P)	JD6,JXD6	3	200-400	480		
		ED4	1	15-100	277		
		HED4	1	15-100	277		
		NDGA,NDGB	2	50-150	480		
		NFGA,NFGB	2	70-250	480		
		FD6-A,FXD6-A	2	70-250	480		
HJD6,HJXD6 (3P)	HJD6,HJXD6 (3P)	FD6,FXD6	2	70-250	480		
		JD6,JXD6	2	200-400	480		
		JD6-A,FXD6-A	3	70-250	480		
		FD6,FXD6	3	70-250	480		
		JD6,JXD6	3	200-400	480		
		JD6-A,FXD6-A	3	200-400	480		
HJXD6 (2,3P)	HJXD6 (2,3P)	NGB,HGB	1	15-125	277		
			2	15-125	277/480		
		NGB,HGB	3	15-125	277/480		
		NGB,HGB	1	15-125	277		
		NGB,HGB	2	15-125	277/480		
		NGB,HGB	3	15-125	277/480		
HJXD6 (3P)	HJXD6 (3P)	NGB,HGB	3	15-125	277/480		
		NDGA,NDGB	3	50-150	480		
		NFGA,NFGB	3	70-250	480		
		NJGA	3	250-400	480		
		NLGA,NLGB	2	400-600	480		
		NLGA,NLGB	3	400-600	480		
HJXD6 (2,3P)	HJXD6 (2,3P)	NGB,HGB	1	15-125	277		
		NGB,HGB	2	15-125	277/480		
		NDGA,NDGB	2	50-150	480		
		NFGA,NFGB	2	70-250	480		
		NJGA	2	250-400	480		
		NLGA,NLGB	2	400-600	480		
HJXD6 (3P)	HJXD6 (3P)	NGB,HGB	3	15-125	277/480		
		NDGA,NDGB	3	50-150	480		
		NFGA,NFGB	3	70-250	480		
		NJGA	3	250-400	480		
		NLGA,NLGB	2	400-600	480		
		NLGA,NLGB	3	400-600	480		

480V Series Ratings (Continued)

Series Rating	Main Breaker		Branch Breaker				
	Max. Amps	Type	Type	Poles	Amps	Volts	
65,000	600	HLD6-A (2,3P)	HED4	1	15-100	277	
			NDGA,NDGB	2	50-150	480	
			NFGA,NFGB	2	70-250	480	
			FD6-A,FXD6-A	2	70-250	480	
			FD6,FXD6	2	70-250	480	
			NJGA	2	200-400	480	
			NLGA,NLGB	2	400-600	480	
			JXD6-A,JD6-A	2	200-400	480	
			LD6-A	2	200-600	480	
			LXD6-A	2	450-600	480	
				2	450-600	480	
			HLD6-A (3P)	HLD6-A (3P)	NDGA,NDGB	3	50-150
		NFGA,NFGB			3	70-250	480
		FD6-A,FXD6-A			3	70-250	480
		FD6,FXD6			3	70-250	480
		NJGA			3	200-400	480
		NLGA,NLGB			3	400-600	480
		HLD6 (2,3P)	HLD6 (2,3P)	JXD6-A,JD6-A	3	200-400	480
				LD6-A	3	200-600	480
				LXD6-A	3	450-600	480
				ED4	1	15-100	277
				HED4	1	15-100	277
				NDGA,NDGB	2	50-150	480
		HLD6 (3P)	HLD6 (3P)	NFGA,NFGB	2	70-250	480
				FD6-A,FXD6-A	2	70-250	480
LD6	2			200-600	480		
LXD6	2			450-600	480		
FD6-A,FXD6-A	3			70-250	480		
FD6,FXD6	3			70-250	480		
HLXD6-A (2,3P)	HLXD6-A (2,3P)	JXD6,JD6	3	200-400	480		
		LD6	3	200-600	480		
		LXD6	3	450-600	480		
		ED4	1	15-100	277		
		HED4	1	15-100	277		
		NDGA,NDGB	2	50-150	480		
		NFGA,NFGB	2	70-250	480		
		FD6-A,FXD6-A	2	70-250	480		
		FD6,FXD6	2	70-250	480		
		NJGA	2	250-400	480		
		JXD6-A,JD6-A	2	200-400	480		
		JXD6,JD6	2	200-400	480		
HLXD6-A (3P)	HLXD6-A (3P)	NLGA,NLGB	2	400-600	480		
		LD6-A	2	200-600	480		
		LD6	2	200-600	480		
		LXD6-A	2	450-600	480		
		LXD6	2	450-600	480		
		NDGA,NDGB	3	50-150	480		
HLXD6 (2,3P)	HLXD6 (2,3P)	NFGA,NFGB	3	70-250	480		
		FD6-A,FXD6-A	3	70-250	480		
		FD6,FXD6	3	70-250	480		
		NJGA	3	250-400	480		
		JXD6-A,JD6-A	3	200-400	480		
		JXD6,JD6	3	200-400	480		
HLXD6 (3P)	HLXD6 (3P)	NLGA,NLGB	3	400-600	480		
		LD6-A	3	200-600	480		
		LD6	3	200-600	480		
		LXD6-A	3	450-600	480		
		LXD6	3	450-600	480		
		ED4	1	15-100	277		
HHLXD6 (2,3P)	HHLXD6 (2,3P)	HED4	1	15-100	277		
		NDGA,NDGB	2	50-150	480		
		NFGA,NFGB	2	70-250	480		
		FD6-A,FXD6-A	2	70-250	480		
		FD6,FXD6	2	70-250	480		
		JXD6,JD6	2	200-400	480		
HHLXD6 (3P)	HHLXD6 (3P)	LD6	2	200-600	480		
		LXD6-A	2	450-600	480		
		LXD6	2	450-600	480		
		NGB,HGB	1	15-125	277		
		FD6-A,FXD6-A	3	70-250	480		
		FD6,FXD6	3	70-250	480		

5 MOLDED CASE CIRCUIT BREAKERS

Molded Case Circuit Breakers

Series Connected Short Circuit Ratings

General

480V Series Ratings (Continued)

Series Rating	Main Breaker		Branch Breaker			
	Max. Amps	Type	Type	Poles	Amps	Volts
65,000	600	HHLXD6 (3P)	NGB,HGB	3	15-125	277/480
		HHLXD6 (2,3P)	NGB,HGB	2	15-125	277/480
		HHLXD6 (3P)	NGB,HGB	3	15-125	277/480
	800	HMG (2,3P)	NDGA,NDGB	2	50-150	480
			NFGA,NFGB	2	70-250	480
			NJGA	2	250-400	480
			NLGA,NLGB	2	400-600	480
			NMG	2	600-800	480
			LMD6,LMXD6	2	600-800	480
			MD6,MXD6	2	400-800	480
			NDGA,NDGB	3	50-150	480
			NFGA,NFGB	3	70-250	480
		NJGA	3	250-400	480	
		HMG (3P)	NLGA,NLGB	3	400-600	480
			NMG	3	600-800	480
			LMD6,LMXD6	3	600-800	480
			MD6,MXD6	3	400-800	480
			NDGA,NDGB	2	50-150	480
			NFGA,NFGB	2	70-250	480
			FXD6,FD6	2	70-250	480
			FXD6-A,FD6-A	2	70-250	480
			NJGA	2	250-400	480
		HMD6,HMXD6 (2,3P)	JXD6,JD6	2	200-400	480
			JXD6-A,JD6-A	2	200-400	480
			NLGA,NLGB	2	400-600	480
			LD6	2	200-600	480
			LD6-A	2	200-600	480
			LXD6	2	450-600	480
			LXD6-A	2	450-600	480
			LMD6,LMXD6	2	600-800	480
			NMG	2	600-800	480
			MD6	2	500-800	480
			HMD6,HMXD6 (3P)	NDGA,NDGB	3	50-150
NFGA,NFGB				3	70-250	480
FXD6,FD6				3	70-250	480
FXD6-A,FD6-A				3	70-250	480
NJGA	3			250-400	480	
JXD6,JD6	3	200-400		480		
JXD6-A,JD6-A	3	200-400		480		
NLGA,NLGB	3	400-600		480		
LD6	3	200-600		480		
1200	HNG (2,3P)	LD6-A	3	200-600	480	
		LXD6	3	450-600	480	
		LXD6-A	3	450-600	480	
		LMD6,LMXD6	3	600-800	480	
		NMG	3	600-800	480	
		MD6	3	500-800	480	
		NDGA,NDGB	2	50-150	480	
		NFGA,NFGB	2	70-250	480	
		NJGA	2	250-400	480	
	HNG (3P)	NLGA,NLGB	2	400-600	480	
		NMG	2	600-800	480	
		LMD6,LMXD6	2	600-800	480	
		MD6,MXD6	2	400-800	480	
		NNG	2	800-1200	480	
		ND6,NXD6	2	800-1200	480	
NDGA,NDGB		3	50-150	480		
NFGA,NFGB		3	70-250	480		
NJGA		3	250-400	480		
HND6,HNXD6 (2,3P)	NLGA,NLGB	3	400-600	480		
	NMG	3	600-800	480		
	LMD6,LMXD6	3	600-800	480		
	MD6,MXD6	3	400-800	480		
	NNG	3	800-1200	480		
	ND6,NXD6	3	800-1200	480		
	NDGA,NDGB	2	50-150	480		
	NFGA,NFGB	2	70-250	480		
	FXD6,FD6	2	70-250	480		
2000	HRD6,HRXD6 (3P)	FXD6-A,FD6-A	2	70-250	480	
		NJGA	2	250-400	480	
		JXD6,JD6	2	200-400	480	
	HND6,HNXD6 (2,3P)	JXD6-A,JD6-A	2	200-400	480	
		NDGA,NDGB	2	50-150	480	
		NFGA,NFGB	2	70-250	480	
		FXD6,FD6	2	70-250	480	
		FXD6-A,FD6-A	2	70-250	480	
		NJGA	2	250-400	480	

480V Series Ratings (Continued)

Series Rating	Main Breaker		Branch Breaker				
	Max. Amps	Type	Type	Poles	Amps	Volts	
65,000	1200	HND6,HNXD6 (2,3P)	NLGA,NLGB	2	400-600	480	
			LD6	2	200-600	480	
			LD6-A	2	200-600	480	
			LXD6	2	450-600	480	
			LXD6-A	2	450-600	480	
			NMG	2	600-800	480	
			LMD6,LMXD6	2	600-800	480	
			MD6,MXD6	2	500-800	480	
			NNG	2	800-1200	480	
			ND6,NXD6	2	800-1200	480	
			NDGA,NDGB	3	50-150	480	
			NFGA,NFGB	3	70-250	480	
			FXD6,FD6	3	70-250	480	
			FXD6-A,FD6-A	3	70-250	480	
			NJGA	3	250-400	480	
		HND6,HNXD6 (3P)	JXD6,JD6	3	200-400	480	
			JXD6-A,JD6-A	3	200-400	480	
			NLGA,NLGB	3	400-600	480	
			LD6	3	200-600	480	
			LD6-A	3	200-600	480	
			LXD6	3	450-600	480	
			LXD6-A	3	450-600	480	
			NMG	3	600-800	480	
			LMD6,LMXD6	3	600-800	480	
			MD6,MXD6	3	500-800	480	
			SMD6	3	500-800	480	
			NNG	3	800-1200	480	
			ND6,NXD6	3	800-1200	480	
			HPG (2,3P)	NDGA,NDGB	2	50-150	480
				NFGA,NFGB	2	70-250	480
		NJGA		2	250-400	480	
		NLGA,NLGB		2	400-600	480	
		NMG		2	600-800	480	
MD6,MXD6	2	400-800		480			
LMD6,LMXD6	2	600-800		480			
NNG	2	800-1200		480			
ND6,NXD6	2	800-1200		480			
HPG (3P)	NPG	2	1200-1600	480			
	NDGA,NDGB	3	50-150	480			
	NFGA,NFGB	3	70-250	480			
	NJGA	3	250-400	480			
	NLGA,NLGB	3	400-600	480			
	NMG	3	600-800	480			
	MD6,MXD6	3	400-800	480			
	LMD6,LMXD6	3	600-800	480			
	NNG	3	800-1200	480			
1600	HPD6,HPXD6 (3P)	ND6,NXD6	3	800-1200	480		
		NPG	3	1200-1600	480		
		NDGA,NDGB	2	50-150	480		
		NFGA,NFGB	2	70-250	480		
		FXD6,FD6	2	70-250	480		
		FXD6-A,FD6-A	2	70-250	480		
		NJGA	2	250-400	480		
		NLGA,NLGB	2	400-600	480		
		NMG	2	600-800	480		
	HRD6,HRXD6 (3P)	NNG	2	800-1200	480		
		NPG	2	1200-1600	480		
		NNG	3	800-1200	480		
		NPG	3	1200-1600	480		
		NDGA,NDGB	2	50-150	480		
		NFGA,NFGB	2	70-250	480		
2000	HRD6,HRXD6 (3P)	FXD6,FD6	2	70-250	480		
		NJGA	2	250-400	480		
		JXD6,JD6	2	200-400	480		
	HRD6,HRXD6 (3P)	JXD6-A,JD6-A	2	200-400	480		
		NDGA,NDGB	2	50-150	480		
		NFGA,NFGB	2	70-250	480		
		FXD6,FD6	2	70-250	480		
		FXD6-A,FD6-A	2	70-250	480		
		NJGA	2	250-400	480		

Molded Case Circuit Breakers

Series Connected Short Circuit Ratings

General

480V Series Ratings (Continued)

Series Rating	Main Breaker		Branch Breaker							
	Max. Amps	Type	Type	Poles	Amps	Volts				
65,000	2000	HRD6,HRXD6 (3P)	FXD6-A,FD6-A	2	70-250	480				
				3	70-250	480				
			NJGA	2	250-400	480				
				3	250-400	480				
			JD6,JXD6	2	200-400	480				
				3	200-400	480				
			JD6-A,JXD6-A	2	200-400	480				
				3	200-400	480				
			NLGA,NLGB	2	400-600	480				
				3	400-600	480				
			LD6	2	200-600	480				
				3	200-600	480				
			LD6-A	2	200-600	480				
				3	200-600	480				
			LXD6	2	450-600	480				
				3	450-600	480				
			LXD6-A	2	450-600	480				
				3	450-600	480				
			NMG	2	600-800	480				
				3	600-800	480				
NNG	2	800-1200	480							
	3	800-1200	480							
NPG	2	1200-1600	480							
	3	1200-1600	480							
100,000	150	LDGA,LDGB (2,3P)	NGB,HGB,LGB	1	15-125	277				
				2	15-125	277/480				
	LDGA,LDGB (3P)	NGB,HGB,LGB	1	15-125	277	277/480				
							2	15-125	277/480	
	LFGA,LFGB (2,3P)	NGB,HGB,LGB	1	15-125	277	277/480				
							NDGB,HDGB	2	50-150	480
								2	50-150	480
							NDGA,HDGA	2	50-150	480
								2	70-250	480
							NFGA,HFGA	2	70-250	480
	2	70-250	480							
	LFGA,LFGB (3P)	NGB,HGB,LGB	3	15-125	277/480	277/480				
							NDGB,HDGB	3	50-150	480
								3	50-150	480
							NDGA,HDGA	3	50-150	480
								3	70-250	480
							NFGA,HFGA	3	70-250	480
	3	70-250	480							
	HFFD6 (2,3P)	NGB,HGB,LGB	1	15-125	277	277/480				
							2	15-125	277/480	
HFFD6 (3P)	NGB,HGB,LGB	3	15-125	277/480	277/480					
						HFFXD6 (2,3P)	NGB,HGB,LGB	1	15-125	277
HFFXD6 (3P)	NGB,HGB,LGB	2	15-125	277/480	277/480					
						HFFXD6 (3P)	NGB,HGB,LGB	3	15-125	277/480
CJD6(-A) (2,3P)	NGB,HGB,LGB	1	15-125	277	277/480					
						CJD6(-A) (3P)	NGB,HGB,LGB	3	15-125	277/480
LJGA (2,3P)	NDGB,HDGB	2	50-150	480	480					
						NDGA,HDGA	2	50-150	480	
							2	70-250	480	
						NFGA,HFGA	2	70-250	480	
							2	70-250	480	
						LJGA (3P)	NDGB,HDGB	3	50-150	480
NDGA,HDGA	3	50-150	480							
	3	70-250	480							
NFGA,HFGA	3	70-250	480							
	3	70-250	480							
HHJD6 (2,3P)	ED4,ED6	1	15-100	277	277					
						HED4,HED6	1	15-100	277	
							2	70-250	480	
						FD6,FXD6	2	70-250	480	
							2	70-250	480	
						FD6-A,FXD6-A	3	70-250	480	
3	70-250	480								
HHJD6 (3P)	FD6,FXD6	3	70-250	480	480					
						HFD6,HFXD6	3	70-250	480	
HHJXD6 (2,3P)	ED4,ED6	1	15-100	277	277					
						HED4,HED6	1	15-100	277	

480V Series Ratings (Continued)

Series Rating	Main Breaker		Branch Breaker				
	Max. Amps	Type	Type	Poles	Amps	Volts	
100,000	400	HHJXD6 (2,3P)	FD6-A,FXD6-A	2	70-250	480	
				2	70-250	480	
			FD6,FXD6	2	70-250	480	
				2	70-250	480	
			HFD6,HFXD6	2	70-250	480	
		2		70-250	480		
		HHJXD6 (3P)	FD6-A,FXD6-A	3	70-250	480	
				3	70-250	480	
			FD6,FXD6	3	70-250	480	
				3	70-250	480	
	HFD6,HFXD6		3	70-250	480		
		LLGA,LLGB (2,3P)	NDGB,HDGB	2	50-150	480	480
	NDGA,HDGA						
				NFGA,HFGA	2	70-250	480
	HFD6,HFXD6				2	70-250	480
				NJGA,HJGA	2	200-400	480
	LLGA,LLGB (3P)		NDGB,HDGB		3	50-150	480
				NDGA,HDGA			
			NFGA,HFGA		3	70-250	480
				HFD6,HFXD6	3	70-250	480
NJGA,HJGA			3		200-400	480	
	HHL6 (2,3P)	NDGB,HDGB	2	50-150	480	480	
NDGA,HDGA							2
			NFGA,HFGA	2	70-250	480	
HFD6,HFXD6				2	70-250	480	
			NJGA,HJGA	2	200-400	480	
HHL6 (3P)		NDGB,HDGB		3	50-150	480	480
			NDGA,HDGA				
		NFGA,HFGA		3	70-250	480	
			HFD6,HFXD6	3	70-250	480	
		NJGA,HJGA		3	200-400	480	
HHLXD6 (2,3P)	NDGB,HDGB		2	50-150	480	480	
		NDGA,HDGA					2
			NFGA,HFGA	2	70-250	480	
		HFD6,HFXD6		2	70-250	480	
			NJGA,HJGA	2	200-400	480	
	HHLXD6 (3P)	NDGB,HDGB		3	50-150	480	480
			NDGA,HDGA				
		NFGA,HFGA		3	70-250	480	
			HFD6,HFXD6	3	70-250	480	
		NJGA,HJGA		3	200-400	480	
LMG (2,3P)	NDGB,HDGB		2	50-150	480	480	
		NDGA,HDGA					2
			NFGA,HFGA	2	70-250	480	
		HFD6,HFXD6		2	70-250	480	
			NJGA,HJGA	2	200-200	480	
	LMG (3P)	NLGB,HLGB		2	400-600	480	480
			NLGA,HLGA				
		MD6,MXD6		2	400-800	480	480
			HMD6,HMXD6				
		NDGB,HDGB		3	50-150	480	480
NDGA,HDGA	3		50-150				
	NFGA,HFGA	3	70-250	480			
HFD6,HFXD6		3	70-250	480			
	NJGA,HJGA	3	200-200	480			
NLGB,HLGB		3	400-600	480	480		

5 MOLDED CASE CIRCUIT BREAKERS

Molded Case Circuit Breakers

Series Connected Short Circuit Ratings

General

480V Series Ratings (Continued)

Series Rating	Main Breaker		Branch Breaker			
	Max. Amps	Type	Type	Poles	Amps	Volts
100,000	800	LMG (3P)	NLGA,HLGA	3	400-600	480
			MD6,MXD6	3	400-800	480
			HMD6,HMXD6	3	400-800	480
		CMD6 (3P)	NDGB,HDGB	2	50-150	480
			NDGA,HDGA	3	50-150	480
			NFGB,HFGB	2	70-250	480
			NFGA,HFGA	3	70-250	480
			FXD6,FD6	2	70-250	480
			FXD6-A,FD6-A	3	70-250	480
			HFD6,HFXD6	2	70-250	480
			HFD6,HFXD6	3	70-250	480
			NJGA,HJGA	2	200-200	480
			NJGA,HJGA	3	200-200	480
			JXD6,JD6	2	200-400	480
			JXD6,JD6	3	200-400	480
			JXD6-A,JD6-A	2	200-400	480
			JXD6-A,JD6-A	3	200-400	480
			HJD6,HJXD6	2	200-400	480
		HJD6,HJXD6	3	200-400	480	
		HJD6-A	2	200-400	480	
		HJXD6-A	2	200-400	480	
		HJD6-A	3	200-400	480	
		HJXD6-A	3	200-400	480	
		NLGB,HLGB	2	400-600	480	
		NLGB,HLGB	3	400-600	480	
		NLGA,HLGA	2	400-600	480	
		NLGA,HLGA	3	400-600	480	
		LD6	2	200-600	480	
		LD6	3	200-600	480	
		LD6-A	2	200-600	480	
		LD6-A	3	200-600	480	
		LXD6	2	450-600	480	
		LXD6	3	450-600	480	
		LXD6-A	2	450-600	480	
		LXD6-A	3	450-600	480	
		HLD6	2	200-600	480	
		HLD6	3	200-600	480	
		HLD6-A	2	200-600	480	
		HLD6-A	3	200-600	480	
		HLXD6	2	450-600	480	
		HLXD6	3	450-600	480	
		HLXD6-A	2	450-600	480	
		HLXD6-A	3	450-600	480	
		MD6,MXD6	2	500-800	480	
		MD6,MXD6	3	500-800	480	
		HMD6,HMXD6	2	500-800	480	
		HMD6,HMXD6	3	500-800	480	
		SCMD6 (3P)	HFD6,HFXD6	2	70-250	480
			HFD6,HFXD6	3	70-250	480
			LNG (2,3P)	NDGB,HDGB	2	50-150
	NDGA,HDGA			2	50-150	480
	NFGB,HFGB			2	70-250	480
	NFGA,HFGA			2	70-250	480
	HFD6,HFXD6			2	70-250	480
	NJGA,HJGA			2	200-400	480
	NLGB,HLGB			2	400-600	480
	NLGA,HLGA			2	400-600	480
	MD6,MXD6	2		400-800	480	
	HMD6,HMXD6	2		400-800	480	
	ND6,NXD6	2		600-1200	480	
	HND6,HNXD6	2		600-1200	480	
	NDGB,HDGB	3		50-150	480	
	NDGA,HDGA	3		50-150	480	
	NFGB,HFGB	3		70-250	480	
	NFGA,HFGA	3	70-250	480		
	LNG (3P)	NDGB,HDGB	3	50-150	480	
		NDGA,HDGA	3	50-150	480	
		NFGB,HFGB	3	70-250	480	

480V Series Ratings (Continued)

Series Rating	Main Breaker		Branch Breaker				
	Max. Amps	Type	Type	Poles	Amps	Volts	
100,000	1200	LNG (3P)	HFD6,HFXD6	3	70-250	480	
			NJGA,HJGA	3	200-400	480	
			NLGB,HLGB	3	400-600	480	
			NLGA,HLGA	3	400-600	480	
			MD6,MXD6	3	400-800	480	
			HMD6,HMXD6	3	400-800	480	
			ND6,NXD6	3	600-1200	480	
			HND6,HNXD6	3	600-1200	480	
			CND6 (3P)	NDGB,HDGB	2	50-150	480
				NDGB,HDGB	3	50-150	480
				NDGA,HDGA	2	50-150	480
				NDGA,HDGA	3	50-150	480
				NFGB,HFGB	2	70-250	480
				NFGB,HFGB	3	70-250	480
				NFGA,HFGA	2	70-250	480
		NFGA,HFGA		3	70-250	480	
		FXD6,FD6		2	70-250	480	
		FXD6,FD6		3	70-250	480	
		FXD6-A,FD6-A		2	70-250	480	
		FXD6-A,FD6-A		3	70-250	480	
		HFD6,HFXD6		2	70-250	480	
		HFD6,HFXD6		3	70-250	480	
		NJGA,HJGA		2	200-400	480	
		NJGA,HJGA	3	200-400	480		
		JXD6,JD6	2	200-400	480		
		JXD6,JD6	3	200-400	480		
		JXD6-A,JD6-A	2	200-400	480		
		JXD6-A,JD6-A	3	200-400	480		
		HJD6,HJXD6	2	200-400	480		
		HJD6,HJXD6	3	200-400	480		
		HJD6-A	2	200-400	480		
		HJXD6-A	2	200-400	480		
		HJD6-A	3	200-400	480		
		HJXD6-A	3	200-400	480		
		NLGB,HLGB	2	400-600	480		
		NLGB,HLGB	3	400-600	480		
		NLGA,HLGA	2	400-600	480		
		NLGA,HLGA	3	400-600	480		
		LD6	2	200-600	480		
		LD6	3	200-600	480		
		LD6-A	2	200-600	480		
		LD6-A	3	200-600	480		
		LXD6	2	450-600	480		
		LXD6	3	450-600	480		
		LXD6-A	2	450-600	480		
		LXD6-A	3	450-600	480		
		HLD6	2	200-600	480		
		HLD6	3	200-600	480		
		HLD6-A	2	200-600	480		
		HLD6-A	3	200-600	480		
	HLXD6	2	450-600	480			
	HLXD6	3	450-600	480			
	HLXD6-A	2	450-600	480			
	HLXD6-A	3	450-600	480			
	MD6,MXD6	2	500-800	480			
	MD6,MXD6	3	500-800	480			
	HMD6,HMXD6	2	500-800	480			
	HMD6,HMXD6	3	500-800	480			
	SCND6 (3P)	HFD6,HFXD6	2	70-250	480		
		HFD6,HFXD6	3	70-250	480		
		LPG (2,3P)	ND6,NXD6	2	600-1200	480	
			HND6,HNXD6	2	600-1200	480	
			ND6,NXD6	3	600-1200	480	
			HND6,HNXD6	3	600-1200	480	
			LPG (3P)	NDGB,HDGB	2	50-150	480
				NDGA,HDGA	2	50-150	480
				NFGB,HFGB	2	70-250	480
				NFGA,HFGA	2	70-250	480
	HFD6,HFXD6			2	70-250	480	
	NJGA,HJGA			2	200-400	480	
	NLGB,HLGB			2	400-600	480	
	NLGA,HLGA			2	400-600	480	
	MD6,MXD6			2	400-800	480	
	HMD6,HMXD6			2	400-800	480	
	LPG (2,3P)		ND6,NXD6	2	600-1200	480	
		HND6,HNXD6	2	600-1200	480		
		ND6,NXD6	3	600-1200	480		
		HND6,HNXD6	3	600-1200	480		
		LPG (3P)	NDGB,HDGB	2	50-150	480	
			NDGA,HDGA	2	50-150	480	
			NFGB,HFGB	2	70-250	480	
			NFGA,HFGA	2	70-250	480	
			HFD6,HFXD6	2	70-250	480	
			NJGA,HJGA	2	200-400	480	
	NLGB,HLGB		2	400-600	480		
	NLGA,HLGA		2	400-600	480		
	MD6,MXD6		2	400-800	480		
	HMD6,HMXD6		2	400-800	480		

Molded Case Circuit Breakers

Series Connected Short Circuit Ratings

General

480V Series Ratings (Continued)

Series Rating	Main Breaker		Branch Breaker				
	Max. Amps	Type	Type	Poles	Amps	Volts	
100,000	1600	LPG (2,3P)	NFGA,HFGA	2	70-250	480	
			HFD6,HFXD6	2	70-250	480	
			NJGA,HJGA	2	200-400	480	
			NLGB,HLGB	2	400-600	480	
			NLGA,HLGA	2	400-600	480	
			MD6,MXD6	2	400-800	480	
			HMD6,HMXD6	2	400-800	480	
			PD6,PXD6	2	1200-1600	480	
			HPD6,HPXD6	2	1200-1600	480	
			LPG (3P)	NDGB,HDGB	3	50-150	480
				NDGA,HDGA	3	50-150	480
				NFGB,HFGB	3	70-250	480
		NFGA,HFGA		3	70-250	480	
		HFD6,HFXD6		3	70-250	480	
		NJGA,HJGA		3	200-400	480	
		NLGB,HLGB		3	400-600	480	
		NLGA,HLGA		3	400-600	480	
		MD6,MXD6		3	400-800	480	
		HMD6,HMXD6		3	400-800	480	
		PD6,PXD6		3	1200-1600	480	
		HPD6,HPXD6		3	1200-1600	480	
		CPD6 (3P)	NDGB,HDGB	2	50-150	480	
			NDGA,HDGA	3	50-150	480	
			NFGB,HFGB	2	70-250	480	
			NFGA,HFGA	3	70-250	480	
			FXD6,FD6	2	70-250	480	
			FXD6-A,FD6-A	3	70-250	480	
			HFD6,HFXD6	2	70-250	480	
			HJGA,HJGA	2	200-400	480	
			NLGB,HLGB	3	400-600	480	
			NLGA,HLGA	2	400-600	480	
			ED4	1	15-100	277	
			HFD6,HFXD6	2	70-250	480	
			JXD6,JD6	2	200-400	480	
			JXD6-A,JD6-A	2	200-400	480	
			HJD6,HJXD6	2	200-400	480	
			HJD6-A	2	200-400	480	
			HJXD6-A	2	200-400	480	
			CJD6(-A) (2,3P)	HFD6,HFXD6	3	70-250	480
		JXD6,JD6		3	200-400	480	
		JXD6-A,JD6-A		3	200-400	480	
		HJD6,HJXD6		3	200-400	480	
		HJD6-A		3	200-400	480	
		HJXD6-A		3	200-400	480	
		CJD6(-A) (3P)		ED4	1	15-100	277
				HFD6,HFXD6	2	70-250	480
				JXD6,JD6	2	200-400	480
				JXD6-A,JD6-A	2	200-400	480
HJD6,HJXD6	2			200-400	480		
HJD6-A	2			200-400	480		
HJXD6-A	2		200-400	480			
CLD6(-A) (2,3P)	LD6		2	200-600	480		
	LD6-A		2	200-600	480		
	LXD6		2	450-600	480		
	LXD6-A		2	450-600	480		
	HLD6		2	200-600	480		
	HLD6-A	2	200-600	480			
	HLXD6	2	450-600	480			
	HLXD6-A	2	450-600	480			
	CLD6(-A) (3P)	HFD6,HFXD6	3	70-250	480		

480V Series Ratings (Continued)

Series Rating	Main Breaker		Branch Breaker						
	Max. Amps	Type	Type	Poles	Amps	Volts			
150,000	600	CLD6(-A) (3P)	JXD6,JD6	3	200-400	480			
			JXD6-A,JD6-A	3	200-400	480			
			HJD6,HJXD6	3	200-400	480			
			HJD6-A	3	200-400	480			
			HJXD6-A	3	200-400	480			
			LD6	3	200-600	480			
			LD6-A	3	200-600	480			
			LXD6	3	450-600	480			
			LXD6-A	3	450-600	480			
			HLD6	3	200-600	480			
			HLD6-A	3	200-600	480			
			HLXD6	3	450-600	480			
			HLXD6-A	3	450-600	480			
			200,000	125	CED6 (2,3P)	NGB,HGB,LGB	1	15-125	277
						ED4	1	15-100	277
						ED4,ED6	2	15-125	480
						HED4	1	15-100	277
						HED4,HED6	2	15-125	480
NGB,HGB,LGB	3	15-125				277/480			
CED6 (3P)	ED4,ED6	3			15-125	480			
	HED4,HED6	3			15-125	480			
	NGB,HGB,LGB	1			15-125	277			
	ED4	1			15-100	277			
	ED4,ED6	2			15-50	480			
	HED4	1			15-100	277			
250	CFD6 (2,3P)	HED4,HED6	2	15-125	480				
		FXD6,FD6	2	70-250	480				
		FXD6-A,FD6-A	2	70-250	480				
		HFD6,HFXD6	2	70-250	480				
		NGB,HGB,LGB	3	15-125	277/480				
		ED4,ED6	3	15-50	480				
		HED4,HED6	3	15-125	480				
		FXD6,FD6	3	70-250	480				
		FXD6-A,FD6-A	3	70-250	480				
		HFD6,HFXD6	3	70-250	480				
		CFD6 (3P)	ED4,ED6	3	15-50	480			
			HED4,HED6	3	15-125	480			
			FXD6,FD6	3	70-250	480			
			FXD6-A,FD6-A	3	70-250	480			
			HFD6,HFXD6	3	70-250	480			

5
MOLDED CASE
CIRCUIT BREAKERS

Molded Case Circuit Breakers

Series Connected Short Circuit Ratings

General

600V Series Ratings

Series Rating	Main Breaker/Fuse		Branch Breaker			
	Max. Amps	Type	Type	Number of Poles	Amperes	Voltage
14,000	125	NGB2 (2,&3P)	BQD6	1	15-70	347
				2,3		347/600
18,000	125	ED6, HED6 (1,2,&3P)	BQD6	1	15-70	347
				2,3		347/600
		ED6 (2,3P)	NGB, NGB2	1	15-125	347
				2,3		347/600
22,000	125	HGB2 (2,&3P)	BQD6	1	15-70	347
				2,3		347/600
	250	HFD6, HFXD6 (2,&3P)	NGB, NGB2	1	15-125	347
				2,3		347/600
25,000	125	LGB2 (2,3P)	BQD6	1	15-70	347
				2,3		347/600
	250	HFD6, HFXD6 (2,&3P)	BQD6	1	15-70	347
				2,3		347/600
			ED6, HED6	2,3	15-125	600
				NGB, NGB2, HGB2	1	15-125
2,3	347/600					
35,000	400	HJD6 (-A), HJXD6 (-A) (2,&3P)	HFD6	2,3	70-250	600
	600	HLD6 (-A) (2,&3P)	HFD6	2,3	70-250	600
		HLXD6 (-A) (2,&3P)	HFD6	2,3	70-250	600
50,000	800	HMD6, HMXD6 (2,&3P)	HFD6	2,3	70	600
			JD6 (-A), JXD6 (-A)	2,3	200-400	600
			HJD6 (-A), HJXD6 (-A)	2,3	200-400	600
			LD6 (-A), HLD6 (-A)	2,3	200-600	600
			LXD6 (-A), HLXD6 (-A)	2,3	450-600	600
			HFD6	2,3	70	600
	1200	HND6, HNXD6 (2,&3P)	JD6 (-A), JXD6 (-A)	2,3	200-400	600
			HJD6 (-A), HJXD6 (-A)	2,3	200-400	600
			LD6 (-A), HLD6 (-A)	2,3	200-600	600
			LXD6 (-A), HLXD6 (-A)	2,3	450-600	600
			HFD6	2,3	70	600
			2,3	70	600	
65,000	250	CFD6 (2,&3P)	BQD6	2,3	15-70	347/600
			ED6, HED6	2,3	15-125	600
	800	CMD6 (2,&3P)	HFD6	2,3	70	600
			JD6 (-A), JXD6 (-A)	2,3	200-400	600
			HJD6 (-A), HJXD6 (-A)	2,3	200-400	600
			LD6 (-A), HLD6 (-A)	2,3	200-600	600
			LXD6 (-A), HLXD6 (-A)	2,3	450-600	600
			HFD6	2,3	70	600
	1200	CND6 (2,&3P)	JD6 (-A), JXD6 (-A)	2,3	200-400	600
			HJD6 (-A), HJXD6 (-A)	2,3	200-400	600
			LD6 (-A), HLD6 (-A)	2,3	200-600	600
			LXD6 (-A), HLXD6 (-A)	2,3	450-600	600
			HFD6	2,3	70	600
			2,3	70	600	
	1600	PD6, HPXD6 (2,&3P)	JD6 (-A), JXD6 (-A)	2,3	200-400	600
			HJD6 (-A), HJXD6 (-A)	2,3	200-400	600
			LD6 (-A), HLD6 (-A)	2,3	200-600	600
			LXD6 (-A), HLXD6 (-A)	2,3	450-600	600
HFD6			2,3	70	600	
2,3			70	600		
CPD6 (2,&3P)		JD6 (-A), JXD6 (-A)	2,3	200-400	600	
		HJD6 (-A), HJXD6 (-A)	2,3	200-400	600	
		LD6 (-A), HLD6 (-A)	2,3	200-600	600	
		LXD6 (-A), HLXD6 (-A)	2,3	450-600	600	
		HFD6	2,3	70	600	
		2,3	70	600		
100,000	125	CED6 (2,&3P)	BQD6	1	15-70	347
			2,3	347/600		
			ED6, HED6	2,3	15-125	600
			NGB, NGB2, HGB2, LGB2	1	15-125	347
	2,3	347/600				
	250	CFD6 (3P)	BQD6	1	15-70	347
			ED6, HED6	2,3	15-125	600
			HFD6	2,3	70-250	600
			NGB, NGB2, HGB2, LGB2	1	15-125	347
			2,3	347/600		

Molded Case Circuit Breakers

Series Connected Short Circuit Ratings

General

240 Volt Fuse Series Ratings

Series Connected Rating	Main Fuse		Branch Breaker		
	Type	Maximum Amperes	Type	No. of Poles	Amperes
65,000	J,R (1, 2, 3P)	600	QPH	1	15-70
			BQH,BLH	1	15-70
			QPH	2	15-125
	J,R (2, 3P)	600	BQH,BLH	2	15-125
			QN,QNH	2	150-200
			QNR,QNRH	2	150-200
	J,R (3P)	600	QPH	3	15-100
	T (1, 2 3P)	1200	BQH,BLH	3	15-100
			QPH	1	15-70
			BQH,BLH	1	15-70
	T (2, 3P)	1200	QPH	2	15-125
			BQH,BLH	2	15-125
			QN,QNH	2	150-200
	T (3P)	1200	QNR,QNRH	2	150-200
			QPH	3	15-100
			BQH,BLH	3	15-100
	L (1, 2 3P)	6000	QPH	1	15-70
			BQH,BLH	1	15-70
			QPH	2	15-125
	L (2, 3P)	6000	BQH,BLH	2	15-125
			QN,QNH	2	150-200
			QNR,QNRH	2	150-200
	L (3P)	6000	QPH	3	15-100
			BQH,BLH	3	15-100
QP,BQ,BL			1	15-70	
100,000	T(300V) (1, 2 3P)	200	QT	1,2	15-50
			QPF,BQF,BLF	1	15-30
			QE,BE,BLE	1	15-30
			QPHF,BQHF	1	15-30
			BLHF	1	15-30
			QEH,BLEH	1	15-30
			QPF2,BLF2	1	15-30
			QPHF2,BLHF2	1	15-30
			HQPF2,HBLF2	1	15-30
			QAF,BQAF,BAF	1	15-20
			QAFH,BQAFH	1	15-20
			BAFH	1	15-20
			QAF2,BAF2	1	15-20
			QAFH2,BAFH2	1	15-20
			HQAF2,HBAF2	1	15-20
			QFGA2,BFGA2	1	15-20
			QFGAH2,BFGAH2	1	15-20
			HQFGA2,HBFGA2	1	15-20
			QP,BQ,BL	2	15-125
			QP,BQ,BL	2	15-125
			QPF,BLF	2	15-60
			QE,BLE	2	15-60
			QPHF,BLHF	2	15-60
			QEH,BLEH	2	15-60
	T(300V) (3P)	200	QP,BQ,BL	3	15-100
			QPH	3	15-100
			BQH,BLH	3	15-100
	T(300V) (1, 2 3P)	600	HQP	3	15-100
			HBO,HBL	3	15-100
			QPH	1	15-70
	T(300V) (2, 3P)	600	BQH,BLH	1	15-70
			HQP	1	15-70
			HBO,HBL	1	15-70
	T(300V) (1, 2 3P)	600	QPH	2	15-125
			BQH,BLH	2	15-125
			HQP	2	15-125
	T(300V) (2, 3P)	600	HBO,HBL	2	15-125
			QR2,QRH2,HQR2	2	100-250
			QR2,QRH2,HQR2	2	100-250
	J,R (2, 3P)	600	ED4	1	15-100
			ED4,ED6	2	15-125
			HED4	1	15-100
			HED4,HED6	2	15-125
			FD6-A,FXD6-A	2	70-250
			FD6-A,FXD6-A	2	70-250

240 Volt Series Ratings (Continued)

Series Connected Rating	Main Fuse		Branch Breaker		
	Type	Maximum Amperes	Type	No. of Poles	Amperes
100,000	J,R (2, 3P)	600	FD6,FXD6	2	70-250
			JXD2-A	2	200-400
			JXD2	2	200-400
			JD6-A,JXD6-A	2	200-400
			JD6,JXD6	2	200-400
			LD6-A	2	200-600
			LD6	2	200-600
			LXD6-A	2	450-600
			LXD6	2	450-600
			QR2,QRH2,HQR2	3	100-250
			QR2,QRH2,HQR2	3	100-250
			ED4,ED6	3	15-125
			HED4,HED6	3	15-125
			FD6-A,FXD6-A	3	70-250
			FD6,FXD6	3	70-250
			JXD2-A	3	200-400
			JXD2	3	200-400
			JD6-A,JXD6-A	3	200-400
			JD6,JXD6	3	200-400
			SJD6-A	3	200-400
			SJD6	3	200-400
			LD6-A	3	200-600
			LD6	3	200-600
			LXD6-A	3	450-600
	LXD6	3	450-600		
	SLD6-A	3	300-600		
	SLD6	3	300-600		
	T (2, 3P)	1200	ED4	1	15-100
			ED4,ED6	2	15-125
			HED4	1	15-100
			HED4,HED6	2	15-125
			FD6-A,FXD6-A	2	70-250
			FD6,FXD6	2	70-250
			JXD2-A	2	200-400
			JXD2	2	200-400
			JD6-A,JXD6-A	2	200-400
			JD6,JXD6	2	200-400
			LD6-A	2	200-600
			LD6	2	200-600
		LXD6-A	2	450-600	
		LXD6	2	450-600	
		ED4,ED6	3	15-125	
		HED4,HED6	3	15-125	
		FD6-A,FXD6-A	3	70-250	
		FD6,FXD6	3	70-250	
		JXD2-A	3	200-400	
		JXD2	3	200-400	
		JD6-A,JXD6-A	3	200-400	
JD6,JXD6		3	200-400		
SJD6-A		3	200-400		
SJD6		3	200-400		
LD6-A	3	200-600			
LD6	3	200-600			
LXD6-A	3	450-600			
LXD6	3	450-600			
SLD6-A	3	300-600			
SLD6	3	300-600			
T (3P)	1200	ED4	1	15-100	
		ED4,ED6	2	15-125	
		HED4	1	15-100	
		HED4,HED6	2	15-125	
		FD6-A,FXD6-A	2	70-250	
		FD6,FXD6	2	70-250	
	6000	JXD2-A	2	200-400	
		JXD2	2	200-400	
		JD6-A,JXD6-A	2	200-400	
		JD6,JXD6	2	200-400	
		LD6-A	2	200-600	
		LD6	2	200-600	
LXD6-A	2	450-600			
LXD6	2	450-600			
SLD6-A	2	300-600			
SLD6	2	300-600			

5 MOLDED CASE CIRCUIT BREAKERS

Molded Case Circuit Breakers

Series Connected Short Circuit Ratings

General

240 Volt Series Ratings (Continued)

Series Connected Rating	Main Fuse		Branch Breaker		
	Type	Maximum Amperes	Type	No. of Poles	Amperes
100,000	L (2, 3P)	6000	LXD6	2	450-600
			PD6,PXD6	3	1200-1600
			RD6,RXD6	3	1600-2000
			ED4,ED6	3	15-125
			HED4,HED6	3	15-125
			FD6-A,FXD6-A	3	70-250
			FD6,FXD6	3	70-250
			JXD2-A	3	200-400
			JXD2	3	200-400
			JD6-A,JXD6-A	3	200-400
			JD6,JXD6	3	200-400
			SJD6-A	3	200-400
			SJD6	3	200-400
			LD6-A	3	200-600
	LD6	3	200-600		
	L (3P)	LXD6-A	3	450-600	
		LXD6	3	450-600	
		SLD6-A	3	300-600	
		SLD6	3	300-600	
		SMD6	3	500-800	
		SND6	3	500-1200	
		PD6,PXD6	3	1200-1600	
		SPD6	3	1400-1600	
		RD6,RXD6	3	1600-2000	
		QJ2	2	125-200	
		QJH2,QJ2H	2	125-200	
		QJ2	3	125-200	
		QJH2,QJ2H	3	125-200	
QJ2		2	125-225		
QJ2	3	125-225			
200,000	R (2, 3P)	200	QJH2,QJ2H	2	125-225
	R (3P)	200	QJH2,QJ2H	3	125-225
	T,J (2, 3P)	400	QJ2	2	125-225
	T,J (3P)		QJ2	3	125-225
	T,J (2, 3P)	600	QJH2,QJ2H	2	125-225
	T,J (3P)		QJH2,QJ2H	3	125-225
	J,R (1, 2, 3P)		NGB,HGB,LGB	1	15-125
	J,R (2, 3P)		NGB,HGB,LGB	2	15-125
			NDGB,HDGB	2	50-150
			NDGA,HDGA	2	50-150
			NFGA,HFGA	2	70-250
			NFGB,HFGB	2	70-250
			HFD6,HFXD6	2	70-250
			NJGA,NJJA	2	200-400
			HJGA	2	200-400
			NLGA,HLGA	2	400-600
			NLGB,HLGB	2	400-600
			NGB,HGB,LGB	3	15-125
		NDGB,HDGB	3	50-150	
		NDGA,HDGA	3	50-150	
		NFGA,HFGA	3	70-250	
	NFGB,HFGB	3	70-250		
	HFD6,HFXD6	3	70-250		
	NJGA,NJJA	3	200-400		
	HJGA	3	200-400		
	NLGA,HLGA	3	400-600		
	NLGB,HLGB	3	400-600		
	J,R (3P)	NGB,HGB,LGB	1	15-125	
NGB,HGB,LGB		2	15-125		
NDGB,HDGB		2	50-150		
NDGA,HDGA		2	50-150		
NFGA,HFGA		2	70-250		
NFGB,HFGB		2	70-250		
HFD6,HFXD6		2	70-250		
NJGA,NJJA		2	200-400		
HJGA		2	200-400		
NLGA,HLGA		2	400-600		
NLGB,HLGB		2	400-600		
NGB,HGB,LGB		3	15-125		
NDGB,HDGB		3	50-150		
NDGA,HDGA		3	50-150		
NFGA,HFGA	3	70-250			
NFGB,HFGB	3	70-250			
HFD6,HFXD6	3	70-250			
T (1, 2, 3P)	NGB,HGB,LGB	1	15-125		
	NGB,HGB,LGB	2	15-125		
	NDGB,HDGB	2	50-150		
	NDGA,HDGA	2	50-150		
	NFGA,HFGA	2	70-250		
	NFGB,HFGB	2	70-250		
	HFD6,HFXD6	2	70-250		
	NJGA,NJJA	2	200-400		
	HJGA	2	200-400		
	NLGA,HLGA	2	400-600		
	NLGB,HLGB	2	400-600		
	NGB,HGB,LGB	3	15-125		
	NDGB,HDGB	3	50-150		
	NDGA,HDGA	3	50-150		
NFGA,HFGA	3	70-250			
NFGB,HFGB	3	70-250			
HFD6,HFXD6	3	70-250			
T (2, 3P)	NGB,HGB,LGB	1	15-125		
	NGB,HGB,LGB	2	15-125		
	NDGB,HDGB	2	50-150		
	NDGA,HDGA	2	50-150		
	NFGA,HFGA	2	70-250		
	NFGB,HFGB	2	70-250		
	HFD6,HFXD6	2	70-250		
	NJGA,NJJA	2	200-400		
	HJGA	2	200-400		
	NLGA,HLGA	2	400-600		
	NLGB,HLGB	2	400-600		
	NGB,HGB,LGB	3	15-125		
	NDGB,HDGB	3	50-150		
	NDGA,HDGA	3	50-150		
NFGA,HFGA	3	70-250			
NFGB,HFGB	3	70-250			
HFD6,HFXD6	3	70-250			
T (3P)	NGB,HGB,LGB	1	15-125		
	NGB,HGB,LGB	2	15-125		
	NDGB,HDGB	2	50-150		
	NDGA,HDGA	2	50-150		
	NFGA,HFGA	2	70-250		
	NFGB,HFGB	2	70-250		
	HFD6,HFXD6	2	70-250		
	NJGA,NJJA	2	200-400		
	HJGA	2	200-400		
	NLGA,HLGA	2	400-600		
	NLGB,HLGB	2	400-600		
	NGB,HGB,LGB	3	15-125		
	NDGB,HDGB	3	50-150		
	NDGA,HDGA	3	50-150		
NFGA,HFGA	3	70-250			
NFGB,HFGB	3	70-250			
HFD6,HFXD6	3	70-250			

240 Volt Series Ratings (Continued)

Series Connected Rating	Main Fuse		Branch Breaker		
	Type	Maximum Amperes	Type	No. of Poles	Amperes
200,000	T (3P)	1200	NJGA,NJJA	3	200-400
			HJGA	3	200-400
			NLGA,HLGA	3	400-600
			NLGB,HLGB	3	400-600
			NDGB,HDGB	2	50-150
			NDGA,HDGA	2	50-150
			NFGA,HFGA	2	70-250
			NFGB,HFGB	2	70-250
			HFD6,HFXD6	2	70-250
			NJGA,NJJA	2	200-400
			HJGA	2	200-400
			NLGA,HLGA	2	400-600
	NLGB,HLGB	2	400-600		
	MD6,MXD6	2	500-800		
	HMD6,HMXD6	2	500-800		
	ND6,NXD6	2	500-1200		
	HND6,HNXD6	2	500-1200		
	L (2, 3P)	6000	NDGB,HDGB	3	50-150
			NDGA,HDGA	3	50-150
			NFGA,HFGA	3	70-250
			NFGB,HFGB	3	70-250
			HFD6,HFXD6	3	70-250
			NJGA,NJJA	2	200-400
			HJGA	2	200-400
			NLGA,HLGA	3	400-600
			NLGB,HLGB	3	400-600
			MD6,MXD6	3	500-800
			HMD6,HMXD6	3	500-800
			ND6,NXD6	3	500-1200
	HND6,HNXD6	3	500-1200		
	L (3P)	6000	NDGB,HDGB	3	50-150
			NDGA,HDGA	3	50-150
			NFGA,HFGA	3	70-250
			NFGB,HFGB	3	70-250
			HFD6,HFXD6	3	70-250
			NJGA,NJJA	3	200-400
HJGA			3	200-400	
NLGA,HLGA			3	400-600	
NLGB,HLGB			3	400-600	
MD6,MXD6			3	500-800	
HMD6,HMXD6			3	500-800	
ND6,NXD6			3	500-1200	
HND6,HNXD6	3	500-1200			

480 Volt Fuse Series Ratings

Series Connected Rating	Main Breaker		Branch Breaker		
	Type	Maximum Amperes	Type	No. of Poles	Amperes
50,000	J (1,2,3P)	400	ED4	1	60-100
	J (2,3P)		ED4	2	15-100
	J (3P)		ED4	3	15-100
100,000	J (1,2,3P)	600	ED4	1	15-50
	T,J (2,3P)		FXD6,FD6	2	70-250
	T,J (3P)		FXD6-A,FD6-A	2	70-250
			FXD6,FD6	3	70-250
	J,R (2,3P)		FXD6-A,FD6-A	3	70-250
			HFD6,HFXD6	2	70-250
			NDGB,HDGB	2	50-150
			NDGA,HDGA	2	50-150
			NFGB,HFGB	2	70-250
			NFGA,HFGA	2	70-250
			NJGA,HJGA	2	200-400
			NLGB,HLGB	2	400-600
			NLGA,HLGA	2	400-600
			HFD6,HFXD6	3	70-250
NDGB,HDGB		3	50-150		
NDGA,HDGA		3	50-150		
J,R (3P)	NFGB,HFGB	3	70-250		
	NFGA,HFGA	3	70-250		
	NJGA,HJGA	3	200-400		
	NLGB,HLGB	3	400-600		
	NLGA,HLGA	3	400-600		
	HFD6,HFXD6	3	70-250		
	NDGB,HDGB	3	50-150		
	NDGA,HDGA	3	50-150		
	NFGB,HFGB	3	70-250		
	NFGA,HFGA	3	70-250		
	NJGA,HJGA	3	200-400		
	NLGB,HLGB	3	400-600		
	NLGA,HLGA	3	400-600		
	T,J,R (2,3P)	600	FXD6-A,FD6-A	2	200-400
JD6,JXD6			2	200-400	
JD6-A,JXD6-A			2	200-400	
LD6			2	200-600	
LD6-A			2	200-600	
LXD6			2	450-600	
LXD6-A			2	450-600	
HJD6,HJXD6			2	200-400	
HJD6-A			2	200-400	
HJXD6-A			2	200-400	
HJXD6-A			2	200-400	
HLD6			2	200-600	

Molded Case Circuit Breakers

Series Connected Short Circuit Ratings

General

480 Volt Fuse Series Ratings (continued)

Series Connected Rating	Main Breaker		Branch Breaker			
	Type	Maximum Amperes	Type	No. of Poles	Amperes	
100,000	T,J,R (2,3P)	600	HLD6-A	2	200-600	
			HLXD6	2	450-600	
	HLXD6-A		2	450-600		
	JD6,JXD6		3	200-400		
	JD6-A,JXD6-A		3	200-400		
	LD6		3	200-600		
	LD6-A		3	200-600		
	LXD6		3	450-600		
	LXD6-A		3	450-600		
	HJD6,HJXD6		3	200-400		
	HJD6-A	3	200-400			
	HJXD6-A	3	200-400			
	HLD6	3	200-600			
	HLD6-A	3	200-600			
	HLXD6	3	450-600			
	HLXD6-A	3	450-600			
	T (2,3P)	T (2,3P)	1200	HFD6,HFXD6	2	70-250
				NDGB,HDGB	2	50-150
				NDGA,HDGA	2	50-150
				NFGB,HFGB	2	70-250
				NFGA,HFGA	2	70-250
				NJGA,HJGA	2	200-400
				NLGB,HLGB	2	400-600
				NLGA,HLGA	2	400-600
				HFD6,HFXD6	3	70-250
				NDGB,HDGB	3	50-150
	NDGA,HDGA	3	50-150			
	NFGB,HFGB	3	70-250			
	NFGA,HFGA	3	70-250			
	NJGA,HJGA	3	200-400			
	NLGB,HLGB	3	400-600			
	NLGA,HLGA	3	400-600			
	T,L (2,3P)	T,L (2,3P)	1200	JD6,JXD6	2	200-400
				JD6-A,JXD6-A	2	200-400
				LD6	2	200-600
				LD6-A	2	200-600
				LXD6	2	450-600
				LXD6-A	2	450-600
				HJD6,HJXD6	2	200-400
				HJD6-A	2	200-400
				HJXD6-A	2	200-400
				HLD6	2	200-600
	HLD6-A	2	200-600			
	HLXD6	2	450-600			
	HLXD6-A	2	450-600			
	T,L (3P)	T,L (3P)	1200	JD6,JXD6	3	200-400
				JD6-A,JXD6-A	3	200-400
				LD6	3	200-600
				LD6-A	3	200-600
				LXD6	3	450-600
				LXD6-A	3	450-600
				HJD6,HJXD6	3	200-400
				HJXD6-A	3	200-400
				HLD6	3	200-600
				HLD6-A	3	200-600
	HLXD6	3	450-600			
	HLXD6-A	3	450-600			
	L (2,3P)	L (2,3P)	600	NDGB,HDGB	2	50-150
				NDGA,HDGA	2	50-150
				NFGB,HFGB	2	70-250
				NFGA,HFGA	2	70-250
				HFD6,HFXD6	2	70-250
				NJGA,HJGA	2	200-400
				NLGB,HLGB	2	400-600
				NLGA,HLGA	2	400-600
				MD6,MXD6	2	500-800
				HMD6,HMXD6	2	500-800
	ND6,NXD6	2	500-1200			
	HND6,HNXD6	2	500-1200			
	L (3P)	L (3P)	600	NDGB,HDGB	3	50-150

480 Volt Fuse Series Ratings (continued)

Series Connected Rating	Main Breaker		Branch Breaker		
	Type	Maximum Amperes	Type	No. of Poles	Amperes
100,000	L (3P)	600	NDGA,HDGA	3	50-150
			NFGB,HFGB	3	70-250
			NFGA,HFGA	3	70-250
			HFD6,HFXD6	3	70-250
			NJGA,HJGA	3	200-400
			NLGB,HLGB	3	400-600
			NLGA,HLGA	3	400-600
			MD6,MXD6	3	500-800
			HMD6,HMXD6	3	500-800
			ND6,NXD6	3	500-1200
HND6,HNXD6	3	500-1200			
PD6,HPD6	3	1200-1600			
HPD6,HPXD6	3	1200-1600			

600 Volt Fuse Series Ratings

Series Connected Rating	Main Breaker		Branch Breaker			
	Type	Maximum Amperes	Type	No. of Poles	Amperes	Volts
100,000	J, R, T Fuse (2,&3P)	600	JD6 (-A), JXD6 (-A)	2,3	200-400	600
			HJD6 (-A), HJXD6 (-A)	2,3	200-400	600
100,000	J Fuse (2,&3P)	600	LD6 (-A), HLD6 (-A)	2,3	200-600	600
			LXD6 (-A), HLXD6 (-A)	2,3	450-600	600
			FD6-A, FXD6-A	2,3	70-250	600

Molded Case Circuit Breakers

IEC 947-2[®] AC Interrupting Ratings, 50/60 HZ KA

Reference

Ampere Rating	Breaker Frame	Breaker Type	220/240 Volts		380/415 Volts		500 Volts	
			Icu	Ics	Icu	Ics	Icu	Ics
15-125	ED	ED6	65	17	35	9	—	—
70-250	FD	FXD6	65	33	35	18	—	—
		FD6	65	33	35	18	—	—
		HFD6	100	50	65	33	—	—
		HFXD6	100	50	65	33	—	—
		HHFD6	200	100	100	50	—	—
		HFXD6	200	100	100	50	—	—
250-400	JD	JXD6(A)	65	33	40	20	—	—
		JD6(A)	65	33	40	20	—	—
		HJD6(A)	100	50	65	33	—	—
		HJXD6(A)	100	50	65	33	—	—
		HHJD6	200	100	100	50	—	—
		HHJXD6	200	100	100	50	—	—
400-600	LD	LXD6(A)	65	33	40	20	—	—
		LD6(A)	65	33	40	20	—	—
		HLD6(A)	100	50	65	33	—	—
		HLXD6(A)	100	50	65	33	—	—
		HHLD6(A)	200	100	100	50	—	—
		HHLXD6	200	100	100	50	—	—
600-800	MD	MXD6	65	33	40	20	—	—
		MD6	65	33	40	20	—	—
		HMXD6	100	50	65	33	—	—
		HMD6	100	50	65	33	—	—
800-1200	ND	NXD6	65	33	40	20	—	—
		ND6	65	33	40	20	—	—
		HNXD6	100	50	65	33	—	—
		HND6	100	50	65	33	—	—

Molded Case Circuit Breakers

Typical Specifications

Reference

General Specifications

Molded case circuit breakers shall provide circuit overcurrent protection with inverse time and instantaneous tripping characteristics and shall be Siemens Sentron, Sensitrip or approved equal.

All circuit breakers shall be CSA Certified and conform to applicable requirements of NEMA Standard Publication No. AB1.

All circuit breakers shall have a quick-make, quick-break over center toggle type mechanism and the handle mechanism shall be trip free to prevent holding contacts closed against a short circuit or sustained overload. All circuit breaker handles shall assume a position between "ON" and "OFF" when tripped automatically. Multi-pole circuit breakers shall be common-trip such that an overload or short circuit on any one pole will result in all poles opening simultaneously. Arc extinction is to be accomplished by magnetic arc chutes. All ratings are to be clearly visible. When reverse feed is indicated on the drawings, in accordance with CSA, circuit breakers with sealed trip units shall be supplied.

Thermal Magnetic Specifications

Unless otherwise noted on the drawings, all Circuit breakers 2000 Ampere and below shall have thermal-magnetic trip units, with inverse time-current characteristics. Automatic operation of these circuit breakers shall be obtained by means of thermal-magnetic tripping devices located in each pole providing inverse time delay and instantaneous circuit protection. Circuit breakers shall be ambient compensating in that, as the ambient temperature increases over 40°C, the circuit breaker automatically derates itself so as to better protect its associated conductor. Thermal magnetic breakers from 250 to 2000A frames shall have thermal interchangeable trip units, with instantaneous magnetic trip settings that are adjustable and accessible from the front of all circuit breakers on frame sizes 250 Amperes and above. Where indicated, provide circuit breakers CSA Certified for application at 100% of their continuous ampere rating in their intended enclosure.

Motor Circuit Protectors

Where indicated on the drawings and in the combination motor starter/motor control center schedule, furnish instantaneous magnetic trip only circuit breakers for motor short circuit protection. The magnetic trips shall be adjustable and accessible from the front of all circuit breakers frames. The continuous current rating shall be between 1 and 800 Amperes as indicated on the drawing.

The interrupting rating of the circuit breakers shall be as indicated in the specifications, and shown on the drawing or single line diagram. The interrupting rating of the circuit breakers shall be at least equal to the available short circuit current at the line terminals of the circuit breaker and correspond to the CSA Certified integrated short circuit current rating specified.

Internal Accessories

Provide shunt trips, bell alarms, and auxiliary switches as shown on the contract drawings. Gold plated auxiliary switches shall be supplied for PLC connection. Internal accessories for all breakers shall be CSA Certified for field installation and modification.

Connection Accessories

Unless otherwise noted, Mechanical lugs shall be provided with all Molded Case Breakers. Where indicated on the drawings, compression lugs shall be provided on 1200 Ampere frame and below circuit breakers. All compression lugs shall be supplied by the Circuit Breaker Manufacturer. Where indicated on the drawings, CSA Certified plug-in or rear connectors shall be supplied.

Solid State Sensing Specifications

As indicated on the drawings, circuit breaker frames 400 Ampere through 3200-Ampere shall have microprocessor-based RMS sensing trip units, with the capability to measure through to the 21st harmonic. Automatic operation of all circuit breaker frames 400A and larger shall be obtained by means of solid state tripping elements providing inverse time delay and (instantaneous) and/or (short-time delay) circuit protection. Continuous current ratings shall be adjustable from 20% to 100% of the trip unit rating, without the need for a rating plug. Long-time delay and instantaneous trip shall be adjustable. The optional short-time trip function shall have adjustable pick-up settings, three fixed times, and I_t ramp. Circuit breaker frames 400A and larger, and where indicated on the drawings, shall be 100% equipment rated.

Integral Ground Fault Option

Main and feeder circuit breakers, as indicated on the drawings, shall be provided with integral ground fault protection. Ground fault pick-up shall be adjustable from 20% to 70% of the circuit breakers maximum continuous current rating. Ground fault time delay shall be adjustable with three I_t ramps.

Metering Option

When indicated on the drawings, solid state trip breakers shall be furnished with a plug-in or panel mounted metering device. This device shall simultaneously display all three phase currents, as well as average current, ground current, and phase unbalance. In addition it shall display breaker status, a max log, and a trip log. The trip log will retain and display date, time and type of trip (overload, short circuit or ground fault) for the most recent 5 trip events.

Current Limiting Specifications

Where indicated on the drawings, Siemens current limiting circuit breakers are to be furnished. Current limiting circuit breakers shall limit the let-through I_t to a value less than the I_t of one-half cycle wave of the symmetrical prospective current without any fusible elements when operating within its current range.

Series Connected Combination Specifications

Where protective devices are applied in series combination, such that the prospective available fault current exceeds the interrupting rating (AIR) of the downstream protective devices, such combinations shall be CSA Certified combinations. All electrical equipment using these CSA Certified circuit breaker combinations shall be clearly marked.

Molded Case Circuit Breakers

Superseded Breakers

Reference

Sentron Series	Note	Superseded	Note	Superseded
CED62B015-CED62B125 CED62S100A CED63A001-CED63A125 CED63B015-CED63B125 CED63S100A HHED63B015-HHED63B125"	① ① ① ① ① ①	CLE62B015-CLE62B100 CLE62S100 CLE63A001-CLE63A125 CLE63B015-CLE63B100 CLE63S100 HED63B015-HED63B125	③ ③ ③ ③	CE2B015-CE2B100 CE2S100 CE3B015-CEB100 CE3S100
CFD62A150, CFD62L150, CFD62A250 CFD62B070-CFD62B250 CFD62S250A CFD63A150, CFD63L150, CFD63A250 CFD63B070-CFD63B250 CFD63S250A	① ① ① ① ① ①	CLF62A150, CLF62A250 CLF62B070-CLF62B240 CLF62S250 CLF63A150, CLF63A250 CLF63B070-CLF63B250 CLF63S250	③ ③	CJ2B125-CJ2B250 CJ3B125-CJ3B250
CJD62B200-CJD62B400 CJD62H400, CJD62L400 CJD62S400A CJD63B200-CJD63B400 CJD63H400, CJD63L400 CJD63S400A	① ① ① ① ① ①	CLJ62B100-CLJ62B400 CLJ62H400, CLJ62L400 CLJ62S400 CLJ63B200-CLJ63B400 CLJ63H400, CLJ63L400 CLJ63S400	④ ④ ④ ④	CJ2B300-CJ2B400 CJ2S400 CJ3B300-CJ3B400 CJ3S400
CPD63B120-CPD63B160	⑤	CP3B120-CP3B160		
ED21B015-ED21B100 ED22B015-ED22B100 ED22S100A ED23B015-ED23B100 ED23S100A	① ① ① ① ①	E21B015-E21B100 E22B015-E22B100 E22S100A E23B015-E23B100 E23S100A	② ② ② ② ②	EE1B015-EE1B100 EE2B015-EE2B100 EE2S100 EE3B015-EE3B100 EE3S100
ED41B015-ED41B100 ED42B015-ED42B125 ED42S100A ED43B015-ED43B125 ED43S100A	① ① ① ① ①	E41B015-E41B100 E42B015-E42B100 E42S100 E43B015-E43B100 E43S100	② ② ② ② ②	EH1B015-EH1B100 EH2B015-ED2B125 EH2S100 EH3B015-EH3B100 EH3S100
ED61B015-ED61B100 ED62B015-ED62B125 ED62S100A ED63A001-ED63A125 ED63B015-ED63B125 ED63S100A HHED63B015-HHED63B125	① ① ① ① ① ① ①	E61B015-E61B100 E62B015-E62B100 E62S100A E63A001-E63A125 E63B015-E63B100 E63S100A HED63B015-HED63B125	② ② ② ② ② ② ②	EF1B015-EF1B020 EF2B015-EF2B100 EF2S100 EF3A003, EF3J050, EF3L050-EF3A100, EF3H1 EF3B015-EF3B100 EF3S100
FD62B070-FD62B250f FD63B070-FD63B250f	① ①	F62B070, F62B250 F63B070-F63B250		
FXD62A150, FXD62L150, FXD62A250 FXD62B070-FXD62B250f FXD62S250A FXD63A150, FXD63L150, FXD63A250 FXD63B070-FXD63B250f FXD63S250A	① ① ① ① ① ①	FJ62A150, FJ62L150-FJ62A250 FJ62B070-FJ62B250 FJ62S250 FJ63A150, FJ63L150-FJ63A250 FJ63B070-FJ63B250 FJ63S250	② ② ② ② ② ②	FJ2B070-FJ2B225 FJ2S225 FJ3A225 FJ3B070-FJ3B225 FJ3S225
HED41B015-HED41B100 HED42B015-HED42B125 HED43B015-HED43B125 HED61B015-HED61B100	① ① ① ①	HE41B015-HE41B100 HE42B015-HE42B100 HE43B015-HE43B100 HE61B015-HE61B100		
HED63B015-HED63B125	①	HE63B015-HE63B100	② ②	HE2B015-HE2B100 HE3B015-HE3B100
HFD62B070-HFD62B250 HFD63B070-HFD63B250 HHED63B015-HHED63B125	① ① ①	HF62B070-HF62B250 HF63B070-HF63B250 HED63B015-HED63B125		
HJD63B200-HJD63B400	①	HJ63B200-HJ63B400	②	HJ3B125-HJ3B400
HLD63B250-HLD63B600	①	HL63B450-HL63B600	②	HL3B450-HL3B600
HMD63B500-HMD63B800	②	HN3B500-HN3B800		
HND63B100-HND63B120	②	HK3B100-HK3B120		
HPD63B120-HPD63B160	②	HP3B120-HP3B160		
HRD63B160-HRD63B200	②	HR3B160-HR3B200		

① Mechanically and electrically interchangeable.

② Electrically interchangeable only, refer to sales office for further details.

③ Electrically interchangeable only if the system interrupting capacity is less than or equal to:
200 kA at 240V AC
200 kA at 480V AC
100 kA at 600V AC

④ Electrically interchangeable only if the system interrupting capacity is less than or equal to:

200 kA at 240V AC
150 kA at 480V AC
100 kA at 600V AC

⑤ Refer to local sales office for replacement information.

⑥ Effective 1994 — The FD6 and FXD6 types have been replaced by FD6-A and FXD6-A type thermal / magnetic circuit breakers — mechanically and electrically interchangeable with the exception that FXD6-A and FD6-A have 22kA at 600V AC ratings versus 18kA at 600V AC for types FXD6 and FD6.

Molded Case Circuit Breakers

Superseded Breakers

General

Sentron Series	Note	Superseded	Note	Superseded
JD62B200-JD62B400	①	JLB200-JL62B400	②	JL2B070-JL2B400
JD63B200-JD63B400	①	JL63B200-JL63B400	②	JL3B0L0-JL3B400
JXD22B200-JXD22B400	①	JD22B200-JD22B400	②	JD2B250-JD2B400
JXD22S400A	①	JD22S400	②	JD2S400
JXD23B200-JXD23B400	①	JD23B200-JD23B400	②	JD3B250-JD3B400
JXD23S400A	①	JD23S400	②	JD3S400
JXD62B200-JXD62B400	①	JJ62B200-JJ62B400	②	JJ2B250-JJ2B400
JXD62H400, JXD62L400	①	JL62L400, JL62H400	②	JL2L400-JL2H400
JXD62S400A	①	JJ62S400A		
JXD63B200-JXD63B400	①	JJ63B200-JJ63B400	②	JJ3B200-JJ3B400
JXD63H400, JXD63L400	①	JL63A400, JL63H400, JL63L400	②	JL3H400, JL3L400, JL3A225
JXD63S400A	①	JJ63S400A		
LD62B250-LD62B500	①	LL63B250-LL62B600	②	LL2B450-LL2B600
LD62B250-LD63B600	①	LL63B250-LL63B600	②	LL3B450-LL3B600
LXD62B450-LXD62B600	①	LJ62B450-LJ62B600		
LXD62J600, LXD62L600	②	LL2H600, LL2U600, LL2X600		
LXD62S600A	①	LJ62S600		
LXD63B450-LXD63B600	①	LJ63B450-LJ63B600		
LXD64H600, LXD63L600	①	LL63H600, LL63L600	②	LL3A450, LL3H600
LXD63S600A	①	LJ63S600A	②	LL3S600
MD62B500-MD62B800	②	KM2B500-KM2B800		
MD63B500-MD63B800	②	KM3B500-KM3B800		
MXD62A800, MXD62H800, MXD62L800	②	KM2A800, KM2H800, KM2L800		
MXD62S800A	②	KM2S800		
MXD63A800, MXD63H800, MXD63L800	②	KM3A600, KM3H800, KM3L800		
MXD63S800A	②	KM3S800		
ND63B100-ND63B900	②	KP3B100-KP3B900		
NXD63S120A	②	KP3S120		
PD63B120-PD63B160	②	HP3B120-HP3B160		
PXD63S160A	②	HP3S160		
RD63B160-RD63B200	②	HR3B160-HR3B200		
QR22B100 – QR22B225		QJ22B060-QJ22B225		
QR22B100H – QR22B225H		QJ22B060H-QJ22B225H		
HQR23S250HA		QJ22S225		
QJ23B100 – QR23B225		QJ23B060-QJ23B225		
QR23B100H – QR23B225H		QJ23B060H-QJ23B225H		
QRH22B100 – QRH22B225		QJH22B060-QJH22B225		
QRH23B100 – QRH23B225		QJH23B060-QJH23B225		
HQR23S250HA		QJH23S225	①	
QJH22B060-QJH22B225	①	QJ2H125-QJ2B225		
QJH23B060-QJH23B225	①	QJ3H125-QJ3H225		
QJH23S225	①	QJ3S225		
RD63B160-RD63B200	②	HR3B160-HR3B200		
RXD63S200A	②	HR3S200		
SCJD6B200LI-SCJD6B400LI	①	SCJD69200-SCJD69400		
SCJD6B200LIG-SCJD6B400LIG	①	SCJD69200G-SCJD69400G		
SCJD6B200LSIG-SCJD6B400LSIG	①	SCJD69200NGT-SCJD69400NGT		
SCJD6B200LSI-SCJD6B400LSI	①	SCJD69200NT-SCJD69400NT		
SCLD6B300LI-SCLD6B600LI	①	SCLD69300-SCLD69600		
SCLD6B300LIG-SCLD6B600LIG	①	SCLD69300G-SCLD69600G		
SCLD6B300LSIG-SCLD6B600LSIG	①	SCLD69300NGT-SCLD69600NGT		
SCLD6B300LSI-SCLD6B600LSI	①	SCLD69300NT-SCLD69600NT		
SCMD6B600LI-SCMD6B800LI	①	SCMD69600A-SCMD69800A		
SCMD6B600LIG-SCMD6B800LIG	①	SCMD69600AG-SCMD69800AG		
SCMD6B600LSIG-SCMD6B800LSIG	①	SCMD69600ANGT-SCMD69800ANGT		
SCMD6B600LSI-SCMD6B800LSI	①	SCMD69600ANT-SCMD69800ANT		
SCND6B800LI-SCND6B120LI	①	SCND69800A-SCND69120A		
SCND6B800LIG-SCND6B120LIG	①	SCND69800AG-SCND69120AG		
SCND6B800LSIG-SCND6B120LSIG	①	SCND69800ANGT-SCND69120ANGT		
SCND6B800LSI-SCND6B120LSI	①	SCND69800ANT-SCND69120ANT		

①Mechanically and electrically interchangeable.

②Electrically interchangeable only, refer to sales office for further details.

③Electrically interchangeable only if the system interrupting capacity is less than or equal to:

200 kA at 240V AC
200 kA at 480V AC
100 kA at 600V AC

④Electrically interchangeable only if the system interrupting capacity is less than or equal to:

200 kA at 240V AC
150 kA at 480V AC
100 kA at 600V AC

⑤Refer to local sales office for replacement information.

Molded Case Circuit Breakers

Superseded Breakers

General

Sentron Series	Note	Superseded	Note	Superseded
SHJD6B200LI-SHJD6B400LI	①	SHJD69200-SHJD69400	①	SHJ63B200-SHJ63B400G
SHJD6B200LIG-SHJD6B400LIG	①	SHJD69200G-SHJD69400G	①	SHJ63B200G-SHJ63B400G
SHJD6B200LSIG-SHJD6B400LSIG	①	SHJD69200NGT-SHJD69400NGT	①	SHJ63N200G-SHJ63N400G
SHJD6B200LSI-SHJD6B400LSI	①	SHJD69200NT-SHJD69400NT	①	SHJ63N200-SHJ63N400
SHLD6B300LI-SHLD6B600LI	①	SHLD69300-SHLD69600	①	SHL63B300-SHL63B600
SHLD6B300LIG-SHLD6B600LIG	①	SHLD69300G-SHLD69600G	①	SHL63B300G-SHL63B600G
SHLD6B300LSIG-SHLD6B600LSIG	①	SHLD69300NGT-SHLD69600NG	①	SHL63N300G-SHL63N600G
SHLD6B300LSI-SHLD6B600LSI	①	SHLD69300NT-SHLD69600NT	①	SHL63N300-SHL63N600
SHND6B100LI-SHND6B120LI	①	SHND69100A-SHND69120A	①	SHND69100-SHND69800
SHND6B100LIG-SHND6B120LIG	①	SHND69100AG-SHND69120AG	①	SHND69100G-SHND69800G
SHPD6B140LI-SHPD6B160LI	①	SHPD69140-SHPD69160	②	SHPF3B120-SHPF3B160
SHPD6B140LIG-SHPD6B160LIG	①	SHPD69140G-SHPD69160G	②	SHPF3B120G-SHPF3B160G
SHND6B100LSIG-SHND6B120LSIG	①	SHND69100NGT-SHND69800NGT	①	SHKF3N100G-SHKF3N800G
SHND6B100LSI-SHND6B120LSI	①	SHND69100NT-SHND69800NT	②	SHKF3N100-SHKF3N800
SJD6B200LI-SJD6B400LI	①	SJD69200-SJ369400	①	SJL63B200-SJL63B400
SJD6B200LIG-SJD6B400LIG	①	SJD69200G-SJD69400G	①	SJL63B200G-SJL63B400G
SJD6B200LSIG-SJD6B400LSIG	①	SJD69200NGT-SJD69400NGT	①	SJL63N200G-SJL63N400G
SJD6B200LSI-SJD6B400LSI	①	SJD69200NT-SJD69400NT	①	SJL63N200-SJL63N400
SLD6B300LI-SLD6B600LI	①	SLD69300-SLD69600	①	SLL63B300-SLL63B600
SLD6B300LIG-SLD6B600LIG	①	SLD69300G-SLD69600G	①	SLL63B300G-SLL63B600G
SLD6B300LSIG-SLD6B600LSIG	①	SLD69300NGT-SLD69600NGT	①	SLL63N300G-SLL63N600G
SLD6B300LSI-SLD6B600LSI	①	SLD69300NT-SLD69600NT	①	SLL63N300-SLL63N600
SMD6B600LI-SMD6B800LI	①	SMD69600A-SMD69800A	①	SMD69600-SMD69800
SMD6B600LIG-SMD6B800LIG	①	SMD69600AG-SMD69800AG	①	SMD69600G-SMD69800G
SMD6B600LSIG-SMD6B800LSIG	①	SMD69600ANGT-SMD69800ANGT	①	SMD69600NGT-SMD69800NGT
SMD6B600LSI-SMD6B800LSI	①	SMD69600ANT-SMD69800ANT	①	SMD69600NT-SMD69800NT
SND6B800LI-SND6B120LI	①	SND69800A-SND69120A	①	SND69100-SND69800
SND6B800LIG-SND6B120LIG	①	SND69800AG-SND69120AG	①	SND69100G-SND69800G
SND6B800LSIG-SND6B120LSIG	①	SND69800ANGT-SND69120ANGT	①	SND69100NGT-SND69800NGT
SND6B800LSI-SND6B120LSI	①	SND69800ANT-SND69120ANT	①	SND69100NT-SND69800NT
SHPD6B140LI-SHPD6B160LI	①	SPD69140-SPD69160	②	SHPF3B120-SHPF3B160
SHPD6B140LIG-SHPD6B160LIG	①	SPD69140G-SPD69160G	②	SHPF3B120G-SHPF3B160G
SHPD6B140LSIG-SHPD6B160LSIG	①	SPD69140NGT-SPD69160NGT	②	SHPF3N120-SHPF3N160G
SHPD6B140LSI-SHPD6B160LSI	①	SPD69140NT-SPD69160NT	②	SHPF3N120G-SHPF3N160G
—	④	BQCC1B015-BQC1B030		
—	④	CC1B015-CC1B030		
—	④	CC2B015-CC2B030		
—	④	CC3B015-CC3B030		
—	④	EF2A003, EF2H050, EF2L050, EF2A100		
—	④	EF2H150, EF2L150		
—	④	EH1B015-EH1B100		
—	④	EH2B015-EH2B100		
—	④	EH3B015-EH3B100		
—	③	HE2A003, HE2H050, HE2L050-HE2A100		
—	③	HE3A003, HE3H050, HE3L050-HE3A100		
—	③	HE3B015-HE3B100		

①Mechanically and electrically interchangeable.
 ②Electrically interchangeable only, refer to sales office for further details.
 ③These units are for replacement purposes only. Consult sales office for availability.

④These units are no longer manufactured, and no replacement is available.