



Discrete Valve Controllers for On/Off Valves.

A complete line of TopWorx™ discrete valve controllers and monitors for every protocol, application, environment, and hazardous area.



A Global Leader in Valve Control and Proximity Sensing.



Emerson is a global leader in valve control and proximity sensing for the process industries. Our TopWorx solutions enable plants, platforms, and pipelines to manage and control operations more intelligently and efficiently under the most demanding and extreme conditions.

Global Technology Leadership

The technology advancements in TopWorx products are at the forefront of innovation in the process automation industry. TopWorx products use wireless technologies and fieldbus protocols such as FOUNDATION Fieldbus, DeviceNet, AS-Interface, Profibus, and HART to reduce installation costs and enable predictive maintenance.



Global Hazardous Area Certifications

In addition to high temperature +204 °C (+399 °F), cold temperature -50 °C (-58 °F), and sub-sea 7,010 m (23,000 ft) applications, TopWorx products are suitable for use in Flameproof/Explosion Proof, Non-Incendive, Intrinsically Safe hazardous areas with IECEx, ATEX, GOST, InMetro, UL, CSA, KOSHA, and NEPSI certifications.



Global Service & Support

With company locations in the United States, United Kingdom, South Africa, Bahrain, and Singapore, Emerson is strategically positioned to provide outstanding support. In addition, over 200 Certified Product Partners throughout the world are available to provide competent local support when needed.



Discrete Valve Controllers for On/Off Valves

TopWorx discrete valve controllers enable automated on/off valves to communicate via FOUNDATION Fieldbus, DeviceNet, AS-Interface, Profibus, HART and Wireless HART protocols. They attach to all rotary and linear valves and actuators, operate in the most demanding environmental conditions, and carry a variety of hazardous area certifications.

Discrete Valve Controllers for:

- Any bus network
- Any hazardous area
- Any valve or actuator
- Anywhere in the world

TopWorx valve control solutions deliver on today's new customer requirements. With this program, customers enjoy:

- A complete line of valve controllers and monitors for every protocol, application, environment, and hazardous area.
- The world's leading selection of valve networking products, including Foundation Fieldbus, DeviceNet, AS-Interface, and Profibus.
- The most reliable and durable valve position sensor on the planet, the GO Switch.
- On/Off valve control and indication through wireless technology.
- Quality products with global agency approvals including IECEx, ATEX, CE, UL, CSA, as well as NEPSI, KOSHA, InMetro, PESO and EAC.
- The unmatched process experience and bus networking expertise of TopWorx™, the leading provider of valve control and position sensing solutions for the process industries.



TopWorx™ D-Series Discrete Valve Controllers

Built for demanding applications

TopWorx D-Series discrete valve controllers are certified for use in every world area. They carry IECEx, ATEX, and UL certifications in a single model, making it easier for global customers to standardize across plants in multiple world areas. Other certifications available include NEPSI, KOSHA, InMetro, and EAC.

D-Series discrete valve controllers can survive in virtually any plant condition. Their heavy-duty construction and corrosion resistance enable superior performance in the most demanding applications.

The D-Series is Built Tough.

Designed to provide reliable service for a lifetime, the D-Series has been built to last in the most demanding applications, and endurance tested for over 3.5 million cycles to prove it.



Wet

Tested against intense water pressure blasts and complete submersion underwater for 96 hours at a depth of 30 meters.



Hot

Tested for long-term functionality in temperatures up to 176°F/80°C



Cold

Tested for endurance in temperatures down to -76°F/-60°C

Dirty

Tested in dust chamber and proven dust tight

Abusive

Tested against the “300 pound man step test” and proven impact and step resistant

Corrosive

Tested against hundreds of corrosive and caustic elements and proven to resist deterioration or chipping

Explosive

Tested by UL and Sira for use in explosive environments with no seal-off fittings required (DXP, DXS)

Chemical Compatibility

Tested against hundreds of chemicals with varying exposure times, temperatures, and concentrations. Please contact factory for compatibility information.

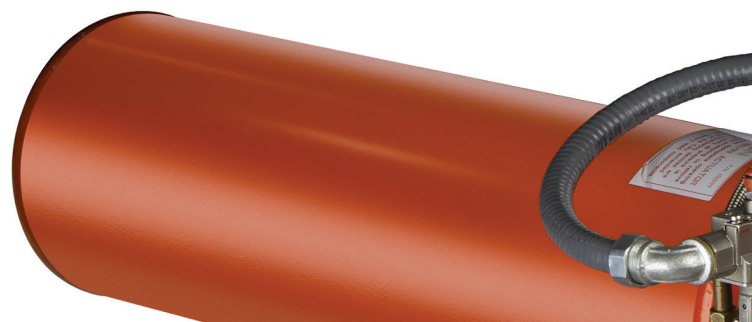

Rugged Enclosures for Every Environment

- Aluminum, Composite, Stainless
- Up to four conduit entries (English or Metric)
- O-ring seals everywhere
- Buna, Silicone o-ring options

Bus Networking / Sensor options

- FOUNDATION Fieldbus, Profibus, DeviceNet, AS-Interface, HART
- GO™ Switch, Proximity, P+FTM™, Mechanical, 4-20mA Transmitter

Pilot Valves

- Aluminum or 316 Stainless Steel
- Low Power Solenoid or Ultra-Low Power Piezo
- Single or Dual Coil
- 1.06 Cv and 3.7 Cv
- Integrally mounted for extra protection
- Built-in filter protects the pilots against debris
- Fast, easy troubleshooting:
 - Pneumatic tubing is color-coded for trouble shooting while system is pressurized
 - Troubleshoot valve without removing the cover

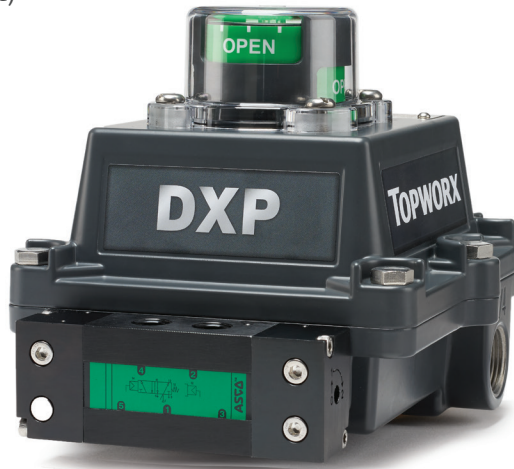

Visual Display

- Impact resistant polycarbonate
- Intuitive colors (Green/Red)
- Adjustable/customizable
- Pre-adjusted to 90° for easy installation
- Less than 1 3/4" tall

Stainless Steel Shaft & Fasteners

- 1/4" DD or NAMUR Shaft
- Captive cover bolts
- Captive dome screws

Environmental Extremes

- Rated for environments from -76°F/-60°C to 347°F/175°C
- NEMA Type 4, 4X, IP66/67

Multiple D-Series Platforms for Every Environment



DXP

Tropicalized Aluminum
 Flameproof/Explosion Proof/Intrinsically Safe
 Class I, Div 1 & 2
 Class II, Div 1 & 2
 Ex ia IIC T6/T4
 Ex d IIB+H2 or IIC T6/T5/T4/T3
 Tamb -60°C up to +175°C
 Ex tb IIIC
 Tamb -50°C up to +92°C
 II2GD, Type 4X, IP66/67



DXS

316 Stainless Steel
 Flameproof/Explosion Proof
 /Intrinsically Safe
 Class I, Div 1 & 2
 Class II, Div 1 & 2
 Ex ia IIC T6/T4
 Ex d IIB+H2 or IIC T6/T5/T4/T3
 Tamb -60°C to +175°C
 Ex tb IIIC T135°C
 Tamb -50°C to +92°C
 II2GD, IP66/67, Type 4X

SIL-3
 IEC 61508



D-ESD

Partial Stroke Testing for
 Emergency Shutdown Valves
 Suitable for use in SIL-3 applications
 Stainless Steel or Aluminum,
 Flameproof/Explosion Proof
 /Non-Incendive
 Class I Div 1 & 2
 Class II Div 1 & 2
 Ex d IIB+H2 T6
 Ex tb IIIC T135°C
 Tamb -50°C to +60°C
 II2GD, IP66/67, Type 4X



DXR

Composite Resin
 Non-Incendive/Intrinsically Safe
 Class I & II, Div 2
 Ex ia IIC T6/T4
 Ex e mb IIC T4
 Ex tb IIIC
 -40°C to +92°C T4
 II2GD, IP65, Type 4X

Note: Product certification markings will vary according to protection method and internal components specified.

TopWorx™ T-Series Switchboxes

High-Value Switchboxes with a Variety of Options

TopWorx T-Series switchboxes deliver outstanding value by providing full functionality in compact, direct-mount enclosures.

Available with a variety of position sensors, integral solenoid valves, and bus networks, the T-Series is suitable for use in all hazardous areas and carry IECEx, ATEX, and UL certifications.

The TopWorx T-Series Delivers Outstanding Value.

Designed to provide maximum functionality in a compact form factor, the TopWorx T-Series has a number of unique features that save space, time, and money.

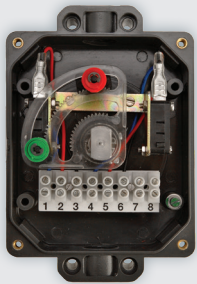

Optimum Use of Space

The unique layout supplies ample working space inside the enclosure for wiring and setting of the switches while taking up very little space above the actuator.



TwistSet™ Cams

Unique TwistSet cam design allows easy access and accurate stepless setting of sensor position with minimum hysteresis.

Color-coded strikers enable quick identification of open/closed switches. Includes locking feature to ensure no target migration.

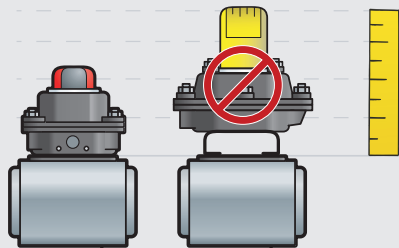

Low Profile Design

The unique direct-mounting feature eliminates expensive mounting brackets while reducing the height of the switchbox and the overall footprint above the actuator.

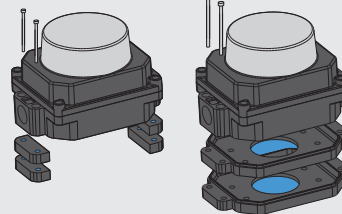

Direct Mounting

Unique mounting design enables simple attachment to any ISO/NAMUR actuator without the need for expensive mounting brackets.



The T-Series direct mount feature helps to reduce cost by omitting the need for custom brackets.



Solid Enclosures for Every Environment

- Aluminum, Composite, Stainless
- Up to four conduit entries (English or Metric)
- O-ring seals everywhere

Bus Networking / Sensor Options

- AS-Interface, Profibus
- GO Switch, Proximity, P+F, Mechanical

Pilot Valves

- Low Power Solenoid
- Single Coil
- 1.0 Cv
- Integrally mounted for extra protection



Visual Display

- Impact resistant polycarbonate
- Intuitive colors (Green/Red)
- Pre-adjusted to 90° for easy installation
- Low profile/High visibility
- Customizable

Environmental Extremes

- Operating temperatures from -76°F/-60°C to +175°F/80°C
- Type 4, 4X, IP66/67

Stainless Steel Shaft and Fasteners

- NAMUR Shaft
- Captive cover bolts and indicator screws

Multiple T-Series Platforms for Every Environment

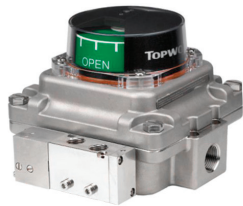

TXS

Direct-Mount Stainless Steel
Flameproof/Intrinsically Safe/
Explosion Proof /Non-Incendive
Class I Div 1 & 2
Class II Div 1 & 2
Ex ia IIC T6/T4/T3
Ex d IIB or IIC T6/T4
Tamb -65°C to 100°C
Ex tb IIIC T135C
Tamb -50°C to 100°C
II2GD, IP66/67, Type 4X



TXP

Direct-Mount Aluminum
Flameproof/Intrinsically Safe/
Explosion Proof /Non-Incendive
Class I Div 1 & 2
Class II Div 1 & 2
Ex ia IIC T6/T4/T3
Ex d IIB or IIC T6/T4
Tamb -65°C to 100°C
Ex tb IIIC T135C
Tamb -50°C to 100°C
II2GD, IP66/67, Type 4X

Note: Product certification markings will vary according to protection method and internal components specified.



TopWorx™ TV-Series Switchboxes

High-Value Switchboxes with a Variety of Options

Compact, rugged, and dependable solution for discrete valve control and valve position monitoring where weight and real estate are at a premium. Light weight and robust enclosures specially designed for non-incendive, intrinsically safe and general purpose application. Each enclosure is suited for heavy wash down and corrosive environments and IP66/68 tested.

Light, Rugged and Compact Enclosure

- Aluminum, Stainless or Aluminum base with clear polycarbonate options
- (2) M20, M25, 1/2NPT, or 3/4NPT conduit options
- Direct ISO/NAMUR mount
- Silicone seals everywhere

Up to (4) Four Sensors Inside

- Factory Sealed GO Switches
- Mechanical –SPDT or DPDT
- Inductive
- Proximity
- NAMUR

Stainless Steel Shaft and Fasteners

- NAMUR Shaft
- Captive cover bolts and indicator screws



Environmental Extremes

- Operating temperatures from -58°F/-50°C to + 185°F/95°C
- NEMA Type 4, 4X

Visual Display

- Impact resistant polycarbonate
- Pre-adjusted to 90° for easy installation
- Intuitive colors
- Customizable

Pilot Valves

- Low or high power solenoid options
- Single or dual coil—single acting or double acting actuators
- Aluminum or Stainless Steel spool valve options

Multiple Tv-Series Platforms for Every Environment

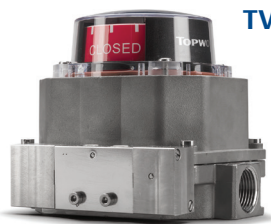

TVH

Stainless Steel
Intrinsically Safe/Non-Incendive
Class I & II, Div 2
Ex ia IIC T6/T4/T3
-65°C up to +100°C
Ex nA nC T4/T3
Tamb -40°C up to +95°C
Ex tc IIIC
-50°C up to +85°C
II2GD, IP66/67, Type 4X,



TVL

Tropicalized Aluminum
Intrinsically Safe/Non-Incendive
Class I & II, Div 2
Ex ia IIC T6/T4/T3
-65°C up to +100°C
Ex nA nC T4/T3
-40°C up to +95°C
Ex tc IIIC
-50°C up to +85°C
II2GD, IP66/67, Type 4X

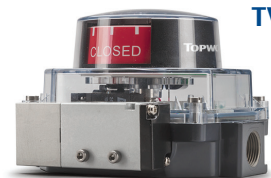

TVF

Tropicalized Aluminum Base with Polycarbonate Lid
Intrinsically Safe/Non-Incendive
Class I & II, Div 2
Ex ia IIC T6/T4/T3
-65°C up to +100°C
Ex nA nC T4/T3
-40°C up to +95°C
II2G, IP66/67, Type 4X



TVA

Direct-Mount Composite Resin
Intrinsically Safe
General Purpose
Ex ia IIC T4 II2G
Tamb -40°C to 60°C

Note: Product certification markings will vary according to protection method and internal components specified.

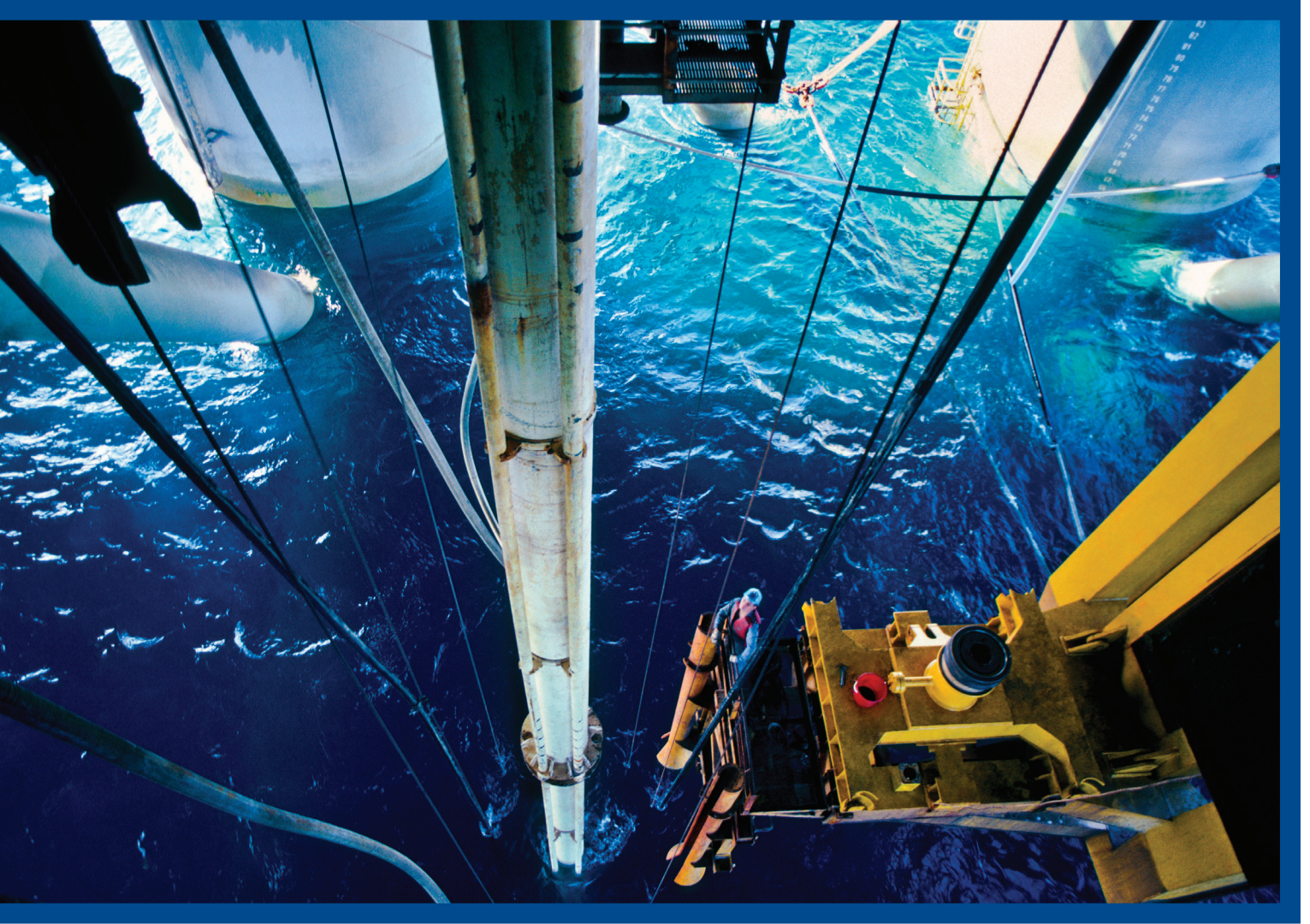

TopWorx™ K-Series Switchboxes

Minimal Maintenance Required

Compact and robust product solution that conforms to the latest European Directives. The use of quality materials and attention to detailed design and manufacturing has resulted in an excellent reputation for reliability.

Solid Enclosures for Every Environment

- Aluminum, Composite, Stainless
- Up to four conduit entries (English or Metric)
- O-ring seals everywhere

Engineered for Dependability

- Available in Aluminum or 316 Stainless Steel
- Unique coating for hazardous locations with Aluminum option
- Red coating for Explosion Proof/Flameproof installations
- Blue coating for Intrinsically Safe installations, including blue terminal strip
- Aluminum enclosures are fully anodized
- RoHS 2 Compliant



Environmental Extremes

- Operating temperatures from -76°F/-60°C to 248°F/120°C
- IP66/67 standard rating
- IP68 to 30 or 150 meters on request
- Type 4, 4X, 6, 6P

316 Stainless Steel Shaft and Fasteners

- VDI/VDE 3845 F05 Mounting
- Special lever options available for linear applications

Visual Display

- Impact resistance polycarbonate
- Static free indicators
- No need to clean with a damp cloth in Hazardous Locations
- Flat-top Options

K1 AND K2 SERIES



K1P
K1S

K1P = Aluminum
K1S = 316 Stainless Steel
Class I & II, Div 1 & 2
Class I, Zone 1, Ex/AEx d IIC T6/T4
Class II, Zone 21, Ex//AEx tb/tD IIIC
Ex ia IIC T6/T4
Ex d IIC T6/T4
Ex tb IIIC
-50°C up to +100°C
Type 4X, IP66/67/68
Conduit Entries: (2)1/2 NPT or M20
Available with (2) switches or a 4-20mA analog or HART transmitter
Unique two point cover reduces commissioning time



K2P
K2S

K2P = Aluminum
K2S = 316 Stainless Steel
Class I & II, Div 1 & 2
Class I, Zone 1, Ex/AEx d IIC T6/T4
Class II, Zone 21, Ex//AEx tb/tD IIIC
Ex ia IIC T6/T4
Ex d IIC T6/T4
Ex tb IIIC
-50°C up to +100°C
Type 4X, IP66/67/68
Conduit Entries: (4)1/2NPT, 3/4NPT, M20 or M25
Available with (4) switch or (2) switches and analog or HART transmitter

Note: Product certification markings will vary according to protection method and internal components specified.

TopWorx™ K-Series

Confidence that your switchbox will work on demand

Robust, Low Profile and Compact

- RoHS 2 compliant
- (2) M20 or 1/2NPT conduits
- Highly accessible internals
- Aluminum enclosure, fully anodized and polyester coated inside and out
- Blue coating for Intrinsically Safe installations, including terminal strip
- Black coating for Ordinary Locations
- Special lever options for linear applications, maximum travel option of 230mm

316 Stainless Steel Shaft and Fasteners

- Two point cover fixing
- Captive lid bolts
- VDI/VDE 3845 F05 Mounting



K5L with Indicator

Visual Display

- Impact resistant polycarbonate
- Static free paint
- Pre-adjusted to 90° for easy installation
- Flat-top options

Environmental Extremes

- Operating temperatures from -58°F/-50°C to 158°F/70°C
- IP66/67

Multiple Switch Options

- Potential Free
- Inductive
- Proximity
- NAMUR

K5L

Available with (2) switches and (2) conduit entries



Ex ia IIC T6/T4
Ex tb IIIC
-50°C up to +70°C
IP66/67

K7L

Available with (4) switches and (2) conduit entries along with 4-20 and HART transmitter options



Ex ia IIC T6/T4
Ex tb IIIC
-50°C up to +70°C
High Temperature Options available up to 400°C



Note: Product certification markings will vary according to protection method and internal components specified.

TopWorx™ K-Series

Durable valve control solutions for elevated and high temperature applications

Ensure your damper is shut down in the event of a fire or power loss. The TopWorx K7L has been specially engineered for high temperature application reliability. Tested by a third party to operate at multiple high temperatures with a varied exposure time for Smoke Dampers or On/Off Valves. With a compact design the K7L provides field proven assurance and accurate process feedback

High temperature wire with pressed-on terminal spades – no lead solder

Ceramic Terminal Strip

High Temperature SPDT switches – test to 400°C

Stainless Steel Cams

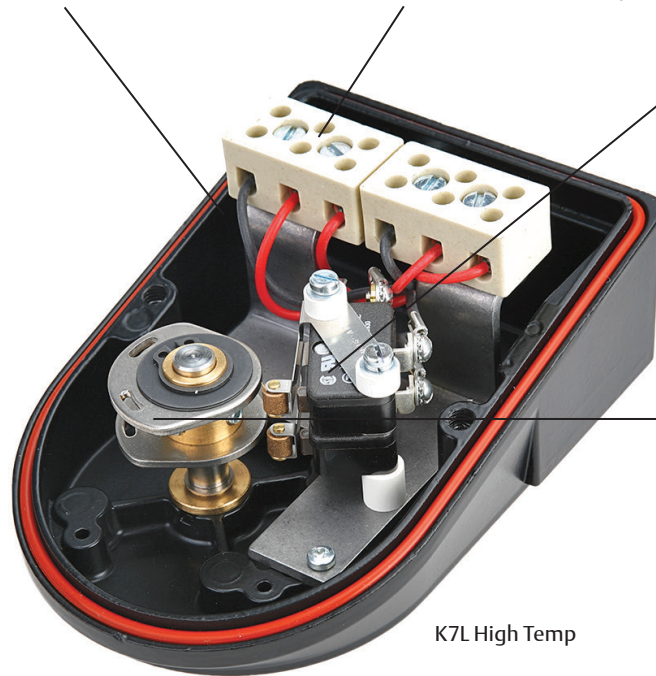

Operating Temperature	Exposure Time	Independently Tested
250°C	3 hours	Yes
300°C	3 hours	Yes
350°C	3 hours	Yes
400°C	3 hours	Yes





TopWorx™ Custom Products

Engineered for your special application

Sub-Sea

KSS - DUPLEX and SUPER DUPLEX

KCS - Carbon steel with custom specified coating

Applications

Depths up to 2500 meters.

Enclosures are available in a range of materials including carbon steel, 316L stainless steel, 254SMO stainless steel (20%Cr-18%Ni-6%Mo), Duplex 2205 and Super Duplex

Available with a wide variety of switches in combination with a 4-20ma transmitters and HART

Custom penetrations can be accommodated to accept a customer specified sub-sea connector or cable entry

Applications

- Rig positioning
- Sub-sea emergency shut down
- Manifold valves and taker loading or balancing



KSS



KCS

High Vibration

- Custom #7338
- Engineered for high vibration applications
- Locked-in target magnets
- Samarium Cobalt target magnets provide a powerful magnetic field that will ensure strong contact pressure
- Available with (2) SPDT GO™ Switches

Applications

- Compressor Stations
- Pump Stations
- Pipes with water hammer
- Flow induced vibration

Example: DXS-L21GNEB000007338

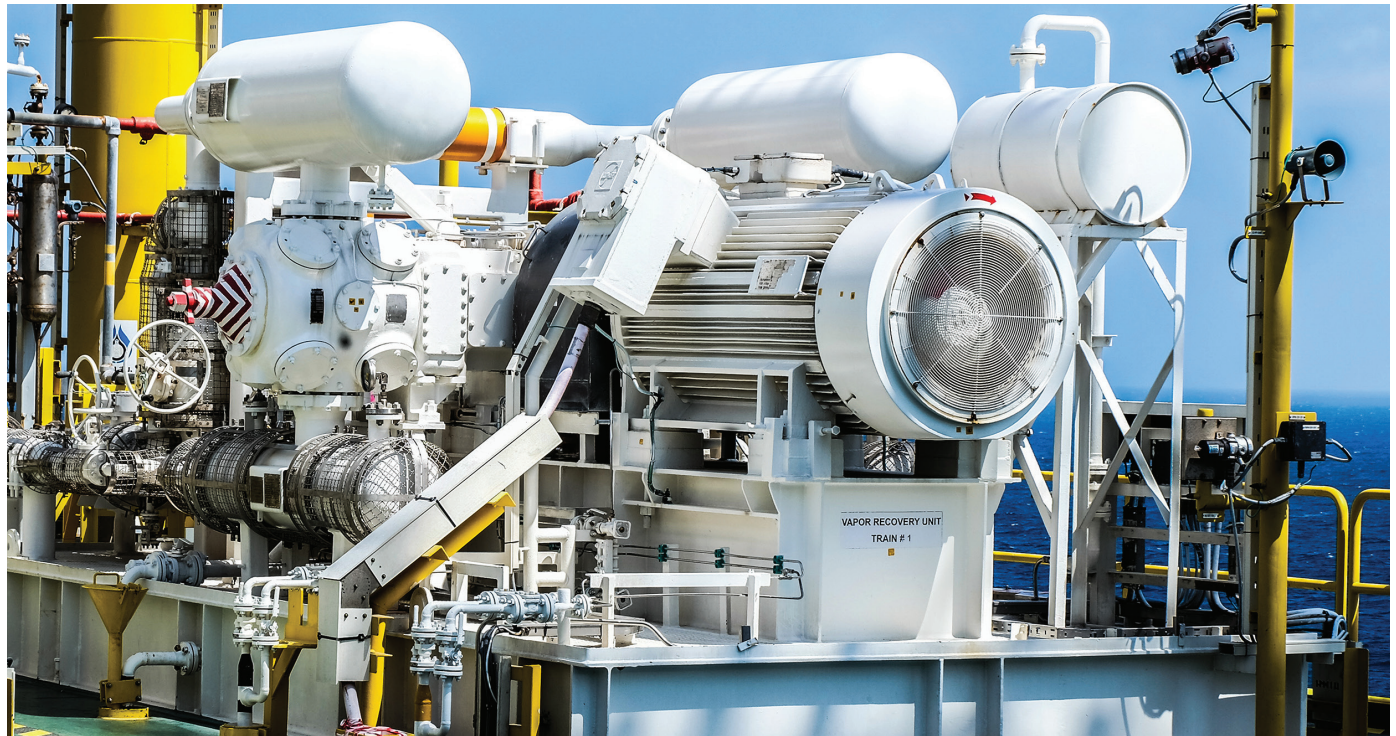
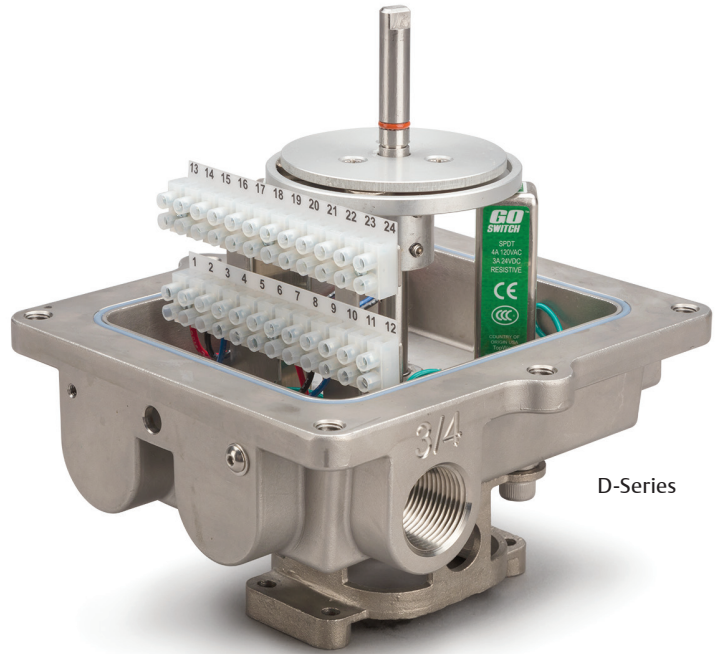

TopWorx™ Bus Networks

Connectivity to Every Fieldbus Network

Sensor-Communication Modules

TopWorx Sensor-Communication Modules are microprocessor based 'brains' that mount inside TopWorx enclosures to deliver position sensing and bus networking functionality to on/off valves. They combine position sensors, bus communications, solenoid outputs, and wiring terminals into a compact, sealed module that drops into various TopWorx enclosures.

SCM Features:

- Short-circuit protection
- Resistant to impact, moisture, shock, vibration, contamination
- LEDs indicate valve position and facilitate sensor set-up



Bus Networks

TopWorx Sensor-Communication Modules make it easy to connect automated on/off valves to modern bus networking protocols such as FOUNDATION Fieldbus, DeviceNet, AS-interface, Profibus, and HART.

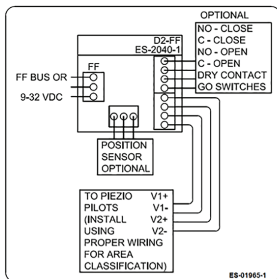

FOUNDATION Fieldbus

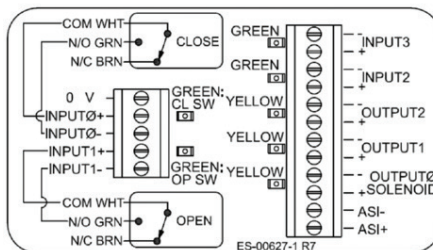

ASi

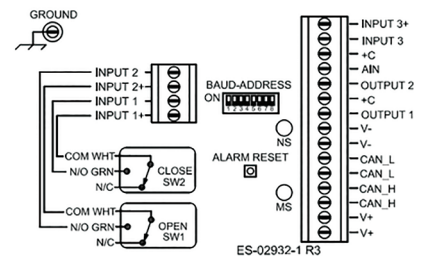

DeviceNet

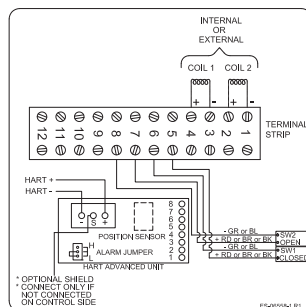

HART

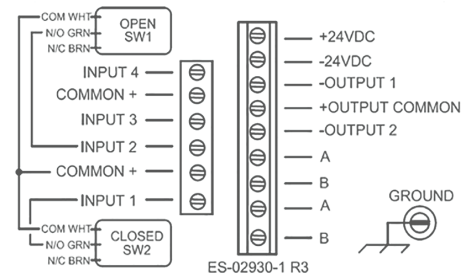

Profibus



FOUNDATION Fieldbus

- Factory programmed with: (2) DI, (1) DO, (1) AI, (1) PID, with the ability to add 10 new function blocks.
- Pre-defined templates, on-board diagnostics, and EDDL-enhanced on-board diagnostics.
- Consumes only 17mA to operate, reduces VCRs and DSTs required
- Local calibration button for factory setting open and closed position.
- Position feedback via DO readback reduces number of function blocks.



HART

- Local user interface via graphic LCD
- Selectable endpoint hysteresis +/- 3%
- Internal device temperature monitoring
- Supports NE-107 and NE-43
- Five-point valve position calibration
- Polarity and overvoltage protection
- Full options of alarms and counters to diagnose potential device problems
- Burst Mode and Event Notification
- Point to Point and Multi-drop mode

Monitoring features

- The two built in cycle counters, a life cycle counter and adjustable counter, with high limit alarm that gives the user needed information to implement a preventative maintenance strategy.
- With built in timers that record valve time in open position, open travel time, and close travel time allowed for failure prediction by trending opening and closing times.

Calibration Switch

Equipped with a local calibration button for pre-installation function testing of the valve actuator package. This ensures that all valve automators can function test packages before installation without having to purchase expensive test equipment. LEDs indicate correct position setting of the switches.

Bus Networking

DeviceNet™

- 3 Discrete Inputs, 2 Discrete Outputs, 1 Analog Input
- Rockwell, Emerson DeltaV approved
- On-board diagnostics and early warning LEDs



- ASi 2.1 with up to 4 Discrete Inputs and 3 Discrete Outputs
- Early warning LEDs



- Profibus DP V0
- 4 Discrete Inputs 2 Discrete Outputs
- Early warning LEDs



- Digital confirmation of analog signal
- Auto-calibration via handheld

TopWorx™ Position Sensors

The Industry's Leading Selection of Position Sensors

Emerson provides the industry's leading selection of TopWorx valve position sensors, including GO™ Switch leverless limit switches, proximity sensors, mechanical limit switches, potentiometers, and 4-20mA position transmitters.

All-In-One Proximity Sensor and Limit Switch

GO Switches are hermetically sealed to outperform all other position sensors in hot, cold, wet, dirty, abusive, corrosive, and explosive conditions. GO Switches deliver best-in-class capabilities:

- Highest amp rating (4amp/120vac, 3amp/24vdc)
- Highest temperature rating: 105°C
- Up to four GO Switches inside
- Hermetically Sealed contacts
- SPDT, DPDT, and Stainless Steel options
- Proximity operation – nothing to jam, bend, break, or wear out
- Resistant to electrical noise, radio frequency interference, dust, dirt, and most chemicals
- No leakage current, not voltage or polarity sensitive
- Simple device – inherently intrinsically safe with barrier
- Unlike reed switches, gold flashed contacts allow for use in both low and high current applications within a single switch



Sensors & Switches

- GO Switch leverless limit switches
- 4-20mA position transmitters with HART protocol
- Proximity
- Reed
- Mechanical

Unique cam design allows quick and accurate setting of the GO Switch positions reducing deadband and hysteresis to a minimum. Switches can easily be set in the mid-position for control applications such as 3-way ball valves or diverter valves.

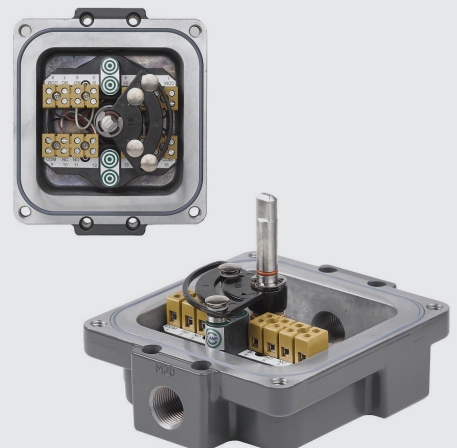

New GO Switch Option in T-Series

Introducing an exciting new GO Switch offering in the T-Series line. This new GO Switch offers the same reliability as existing GO Switches with improved features and benefits. The 36 GO Switch will offer the option of 2 or 4 switch configurations for the TX and TV Enclosures. Integrated solenoid valves are optional in the 2-switch configuration for even more control.

Features:

- Fully encapsulated switch cluster
- Sealed contact
- screw type terminals into the switch cluster
- 1A@24VDC, 3A@24VDC, and 4A@120VAC options
- Tested to 1-million cycles at PLC loads
- Immune to electrical noise

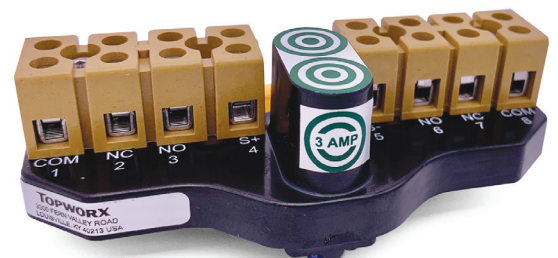

Pilot Valves

Solenoid Valves to Pilot Any Actuator

Emerson provides a portfolio of self-contained ASCO™ pilots and spool valves to control pneumatic actuators. ASCO spool valves are specially designed to stay open for long periods of time and close when needed. The ASCO unique design combines hard T-seal and flexible o-rings, provides bubble-tight shutoff, resistance to dirt, and mutimillion cycle life controlling air or inert gas, making them a perfect fit for any application.

Solenoid Valves

- 24vdc, 120vac, 220vac
- Aluminum, 316 Stainless,
- Single Coil, Dual Coil,
- High Flow up to 3.7Cv
- Low Power Consumption (solenoid 0.5 watts; piezo 12mw)

Pilot Valves

Pilots

- Internally mounted for protection from the environment
- Low Power Solenoid or Ultra-Low Power Piezo pilots
- Single or Dual Pilots
- Fail open, Fail closed, Fail in last position
- 50 million cycle minimum life
- Class F coil insulation (Class H available on request)
- Response time 10mS



Valve Bodies

- Anodized Aluminum
- 316 Stainless Steel

Flow Rates

- 1.06 Cv and 3.7 Cv



Manual Overrides

- Momentary/Latching



Special ASCO seal design with T-Seals are designed to:

- Reduce leakage by applying more pressure to a smaller area around the spool sealing surface
- Self-cleaning design and less sensitive to particulate contamination in the medium
- Provide a dynamic wiping action making them better suited to spool valves than plain “o-rings”
- Eliminate “stiction” with smaller contact area and higher contact pressure provided by the cushioning rings located behind the T-seal

FLAME ARRESTORS

These double as in line filters, protecting the pilot against damage caused by dirty air. This design also allows the users to replace or work on the external valve in situ without affecting the integrity of the explosion proof enclosure.

Integrated metal manifold with color coded tubing for supply and work to allow for easy of trouble shooting. In case of a solenoid failure easily diagnose the failed component: pilot or spool.

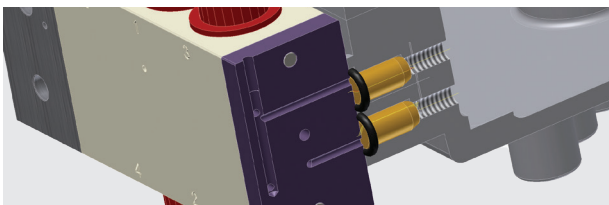

TopWorx™ D-ESD Valve Controllers

SIL-3 Partial Stroke Test Solutions

TopWorx SIL-3 ESD Valve Controllers provide a complete Partial Stroke Test Solution with unique features and functionality that enable partial stroke testing of emergency shutdown valves without disrupting or shutting down the process.

The TopWorx Partial Stroke Test Solution comes complete with:

- Sensor Control Module to partially close the valve without disrupting the process
- Pass/Fail indication via high/low response on the return signal
- Open and Closed position sensors for feedback to the DCS or PLC
- Onboard Diagnostics to enable predictive maintenance and early-warning alerts
- Aluminum, Composite, and 316 Stainless Steel platforms certified for use in Flameproof/Explosion Proof, or Non-Incendive hazardous areas
- An optional local, lockable partial stroke Test Button integral to the unit

The TopWorx Partial Stroke Test Solution provides Onboard Diagnostics to alert the user to the following Dangerous Failures:

- Valve packing/shaft damage
- Actuator spring fatigue/breakage
- Solenoid pilot exhaust blockage
- Solenoid spring failure



Convenient Partial Stroke Testing

Partial Stroke Test Module

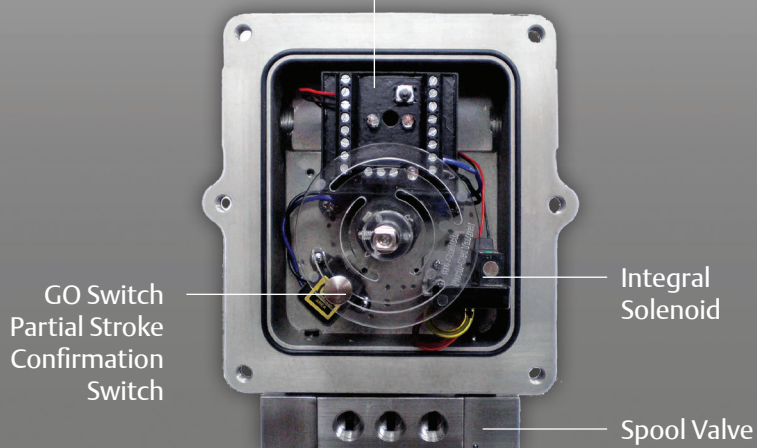
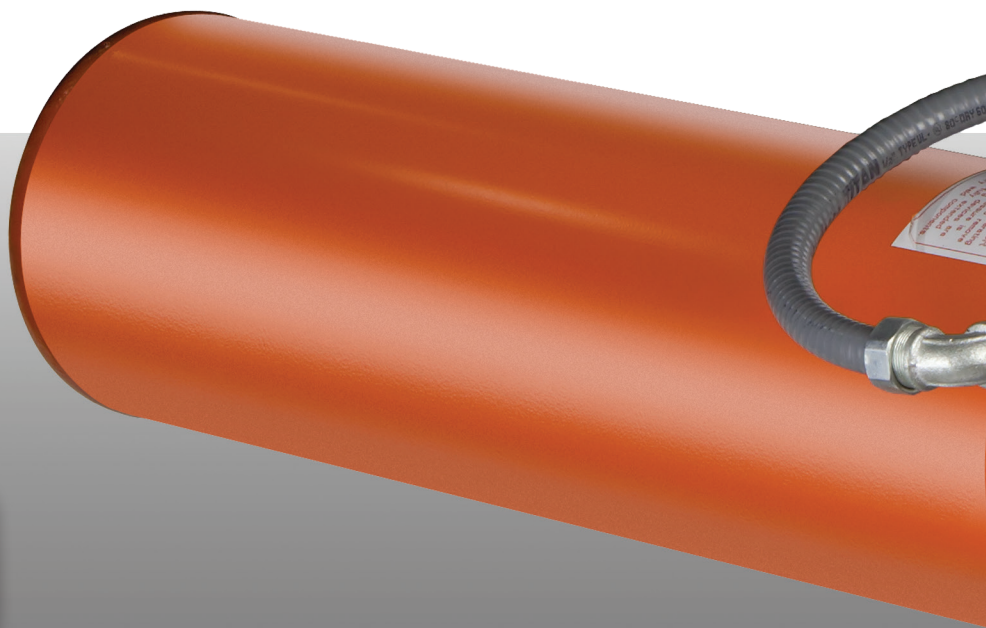

GO Switch
Partial Stroke Confirmation Switch

Integral Solenoid

Spool Valve

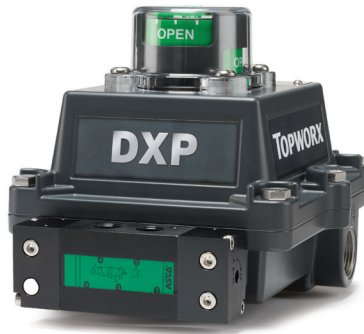

DXP | Tropicalized Aluminum
Flameproof/Explosion Proof

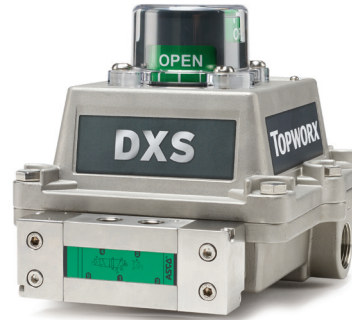

DXS | 316 Stainless Steel
Flameproof/Explosion Proof



Capabilities

- Suitable for use in SIL-3 applications
- Certified for use in hazardous areas
- Integrated solution with all controls in a single housing
- Onboard diagnostics for performance validation

Applications

Valve control solutions for every application

TopWorx SIL-3 ESD Valve Controllers provide a complete Partial Stroke Test Solution with unique features and functionality that enable partial stroke testing of emergency shutdown valves without disrupting or shutting down the process.

The stainless steel, 35-Series GO Switch Hermetically-Sealed, Stainless Steel, DPDT Proximity Switch

For over fifty years, GO Switch, all in one proximity sensor and limit switches, have set the standard for reliability and durability in the process industries. Their unique operating principle and best-in-class capabilities have made them the most specified switch in the world for demanding process applications.

Once again, we have improved on greatness.

The 35-Series GO Switch is available in two versions: The original Single Pole Double Throw GO Switch or the stainless steel, Double Pole Double Throw, version.

Features:

- One-piece, stainless steel housing
- Hermetically-sealed, Double Pole Double Throw contacts
- Suitable for both Ex d and Intrinsically Safe applications
- Up to four (4) switches in a single enclosure
- Extremely low hysteresis
- PLC and higher current ratings with AC/DC
 - NO/NC wiring flexibility
- 4amp/120vac and 3amp/24vdc
- Available with SOV and HART options

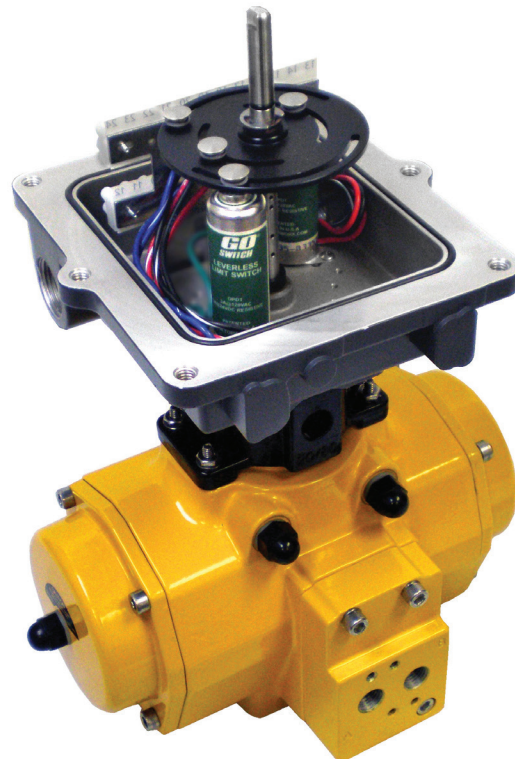

Applications

Valve control solutions for every application

4-20mA POSITION TRANSMITTER

- Fully potted electronic module with LEDs and Auto Calibration feature
- Precise setting of the zero and span can be done in seconds for both CW and CCW rotation with a simple push button
- Position feedback sensor is mounted directly to the switchbox shaft eliminating backlash caused by traditional gear train
- Up to 300° rotation for choke valve applications
- The need for re-calibration is eliminated
- Available with GO Switches

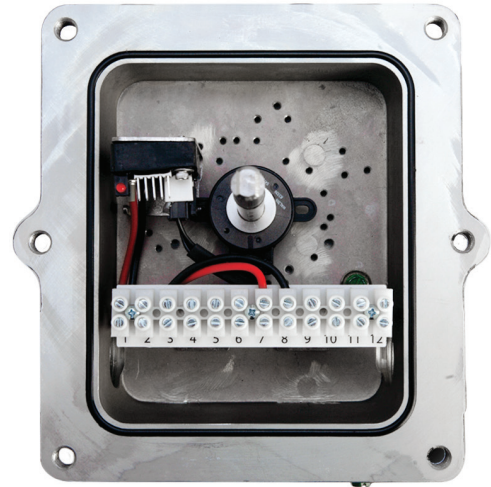

DXP AND DXS with IEC/ATEX IIC Certification The Only IIC Valve Controller with an Integral Solenoid.

Most ATEX Ex d IIC valve controllers have small containers with screw-top lids and very few options. Often the threads on the screw-top lids bind up, causing safety issues on multiple levels. TopWorx is changing all of that with the IIC-certified DXS valve controller.

There is no competition.

The unique modular design of the TopWorx™ discrete valve controller combines bus networking, pilot valve and position sensors into a globally certified, explosion proof enclosure that attaches to any automated valve package.

Features:

- Serrated Flange (No binding of threads)
- Improved ingress protection
- IECEx, ATEX, & Ex d Group IIC
- The only IIC Box with integral solenoid
- Available with all Bus & Sensor options!

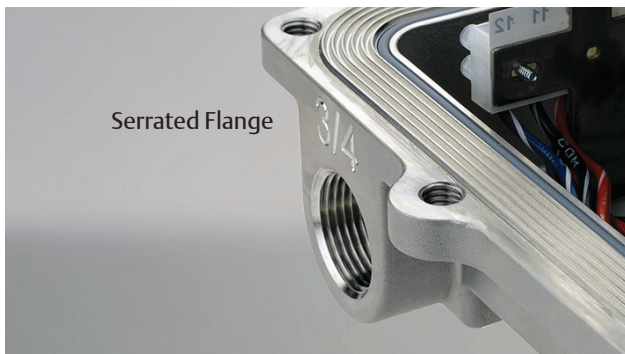
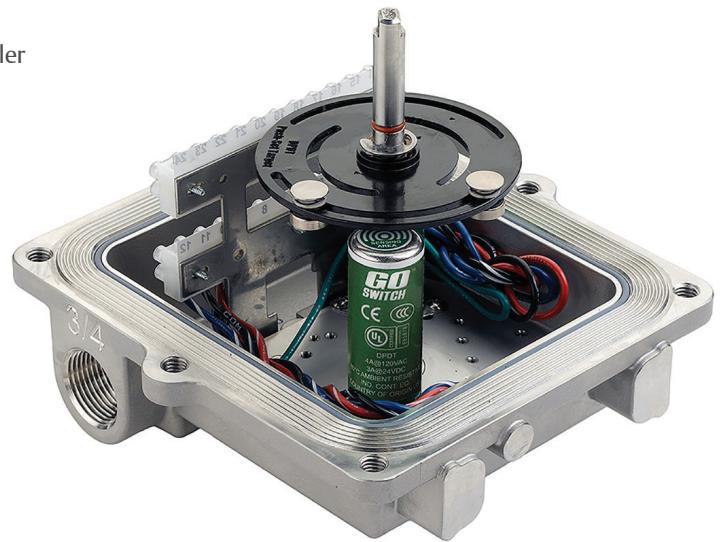

Applications

Valve control solutions for every application

TopWorx™ Visual Indicators

A variety of indicators to fit every application, including multiple color combinations such as Green/Red and Yellow/Black, plus three-way, 90° and 180° flow paths. Other languages are also available upon request.



Cold Temp to -60°C/-76°F

The TopWorx D-Series will give accurate position indication down to -60°C with the use of the GO Switch.



TopWorx TVF Now Available with LED's

The TVF with high intensity LEDs will give you a clear and bright visual indication of your valve state in the darkest of conditions. Have the confidence you need to ensure your valve is in the proper state visually and electrically with TopWorx.

Benefits:

- Intrinsically Safe or Zone 2/Div 2 approved
- Available with GO Switches, reeds, or mechanical
- 10 point terminal strip
- Fully integrated options with internal pneumatics
- Conformal coated PCB board for enhanced reliability
- 24VDC or 120VAC @ 250mA
- Type 4X, IP67 Rated

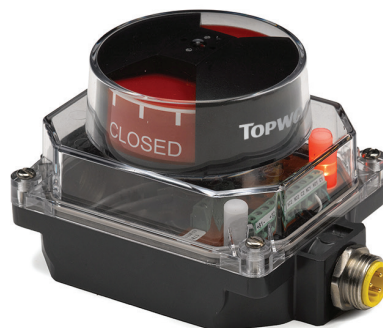
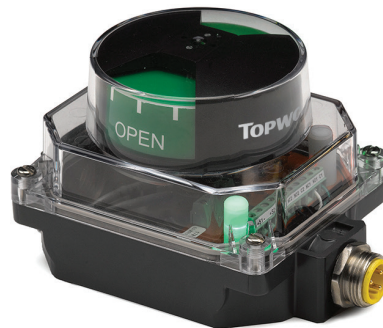

TopWorx™ Mounting Kits

VIP™ Brackets to Fit Any Rotary Valve or Actuator

VIP Mounting Kit

TopWorx valve controllers can be mounted on any rack-n-pinion, scotch-yoke, or vane actuator, quarter-turn manual valves, linear knife-gate and control valves, and positioners.

Visit www.topworx.com for a complete list of available kits or to request a custom design.



Linear Actuator with DXP

We offers thousands of mounting kits to fit a wide variety of valves and actuators. Each kit comes complete with a parts list and installation instructions.

3Z Valve	Larox
Actreg	Ledeen
Airtorque	MAGNETROL
ANCHOR DARLING	Marwin
Apollo	Masoneilan
Automax	Mogas
AXELSON	Neles-Jamesbury
Baumann	Neway
Bettis	Newcon Valve
Biffi	Orbinox
Bray	Orbit
BROOKS BRODIE	PBM
Cameron	PBV
CCI	Poyam
ChemValve	Protech
Clarkson	PVC
Compaq	QTRCO
Conbraco	Radius
Contromatics	RCS
COPES VULCAN	Remote Control
Crane	RF Technologies
DeZurik	Rhino
Durco	Rotork
El-O-Matic	SAMSON
Fabri Valve	Severn Glocon
Fisher	SPEAKMAN
Flowbus	TBV
Flowserve	Triac
General Valve	Trutorq
Grinnell	Unitorq
HAWS	Valtek
HONEYWELL	Valvtechnologies
Hytork	Vanessa
ITT	Velan
KENNETH ELLIOT	VTI
Keystone-Morin	Watts
Kinetrol	WKM
Kitz	Worcester
KTM	Xomox-Matryx

Technical Information

Dimensional Drawings, Electrical Ratings

D-Series MODELS

DXP

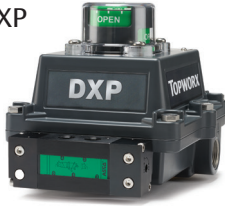

DXR



DXS



TX-Series MODELS

TXP



TXS

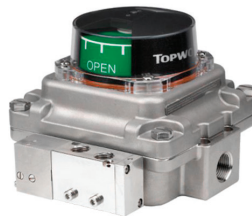

K-Series MODELS

K2P/S



K1P/S



K7L



K5L

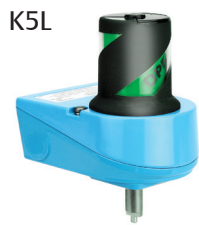

TV-Series Models

TVA

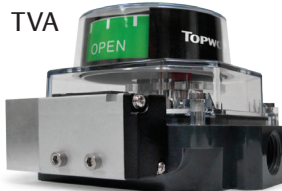

TVF



TVH

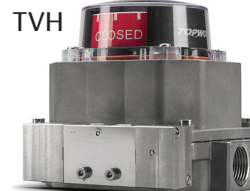

TVL



*Technical information with dimensional drawings are available at Emerson.com/topworx
Please see Installation and Operation Manual for complete product dimensions or contact us
for additional information at info.TopWorx@Emerson.com

Online product configurator

Product datasheets can be generated using the Online Product Configurator. By walking through the selection process, you can easily create the part number and datasheet that meets your application needs. Product datasheets include dimensional data, product options, a wiring diagram, a visual indicator image, and nameplate information.

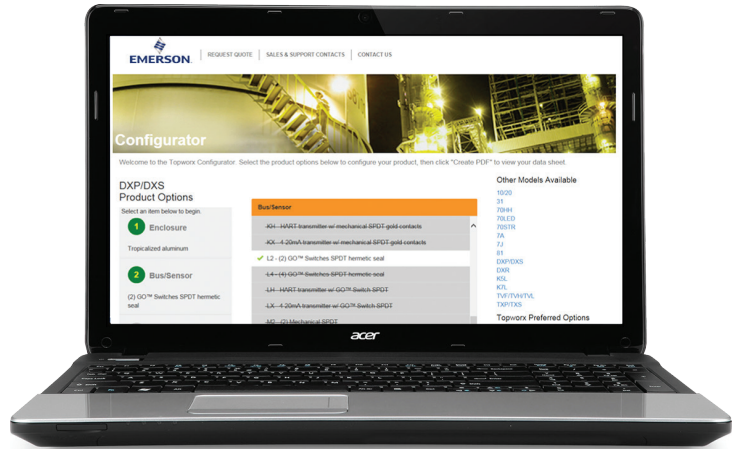

Example Datasheet for model DXP-L21GNEB:

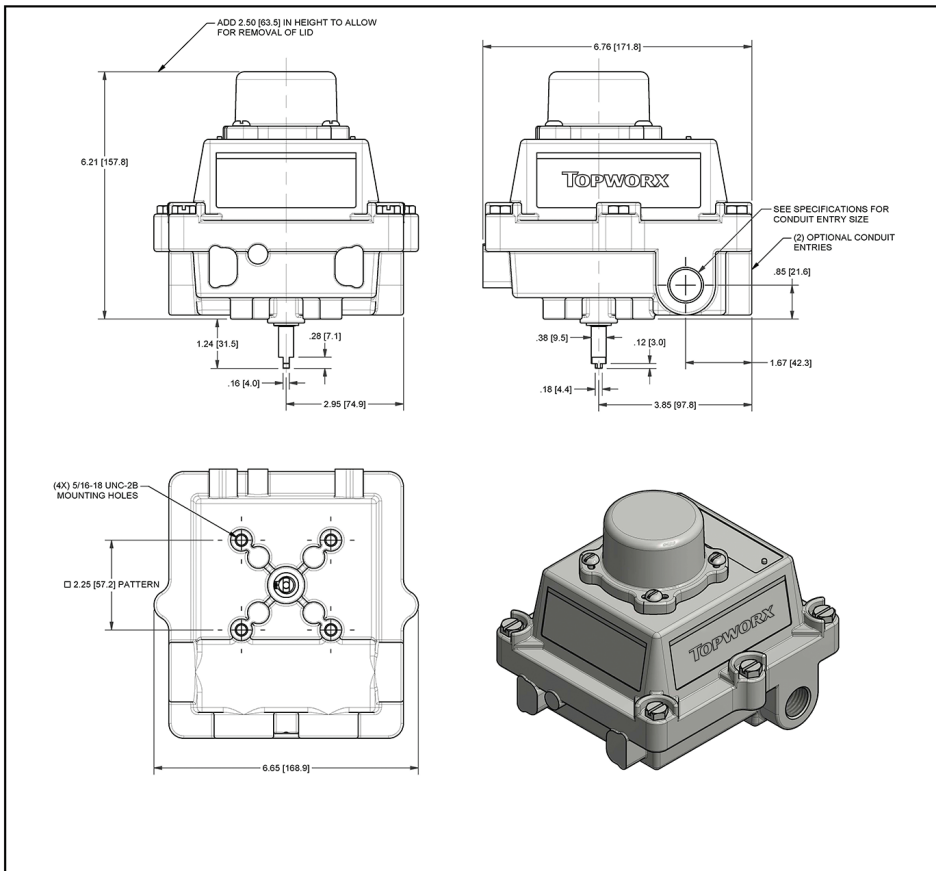

MODEL NUMBER	
DXP-L21GNEB	
PRODUCT LINE	
Switchbox DXP and DXS	
SPECIFICATIONS	
Enclosure	Tropicalized aluminum
Bus/Sensor	(2) GOTM Switches SPDT hermetic seal
Area Classification	Explosion proof / flame proof
Visual Display	Standard 90° Green OPEN, Red CLOSED
Shaft	NAMUR 304 stainless steel
Conduit Entries	(2) 3/4" NPT
O-Rings	Buna-N
Pilot	No pilot device(s)
Spool Valve	No spool valve
Valve Cv	No valve Cv
Manual Override	No manual override
Regional Certification	No regional certification
N Switch	No N Switch

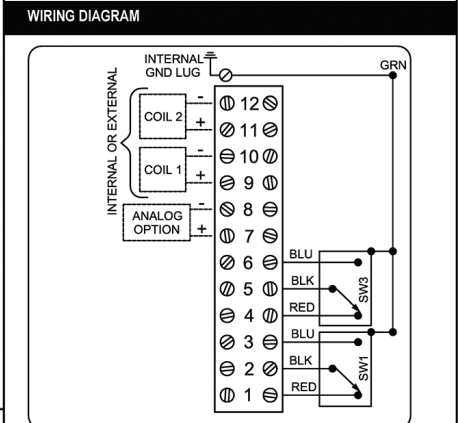

NAMEPLATE

CE 0518 Ex 118 Ex II 1,2,3,4,5,6,7,8,9,10,11,12,13,14,15,16,17,18,19,20,21,22,23,24,25,26,27,28,29,30,31,32,33,34,35,36,37,38,39,40,41,42,43,44,45,46,47,48,49,50,51,52,53,54,55,56,57,58,59,60,61,62,63,64,65,66,67,68,69,70,71,72,73,74,75,76,77,78,79,80,81,82,83,84,85,86,87,88,89,90,91,92,93,94,95,96,97,98,99,100

UL LISTED 125°C 125°C USA

Telemetering Equipment for use in Hazardous Locations
WARNING: Disconnect the power before servicing. Keep tightly closed during operation. Must be known to be non-hazardous area before servicing. Clean only with damp cloth.
AVERTISSEMENT: Débrancher l'alimentation avant l'entretien. Conserver hermétiquement fermé pendant le fonctionnement. Doivent être connus pour être des zones non dangereuses avant l'entretien.

Topworx
 3300 Fern Valley Road
 Louisville, KY 40213 USA
 www.topworx.com
 Serial #:

OPEN **CLOSED**

Current as of May 26, 2017 – Subject to change without notice.

TOPWORX
 3300 Fern Valley Road
 Louisville, KY 40213

(502)969-3000 PH
 (502)969-5911 FAX
 www.topworx.com

Technical Information

Dimensional Drawings, Electrical Ratings

GO Switches

Option	Contact Type	Contact Form	Electrical Rating
L	Gold-Flashed, Dry-Contact	SPDT	4A@120VAC, 3A@24VDC
Z	Palladium Silver, Dry-Contact	DPDT	4A@120VAC, 3A@24VDC

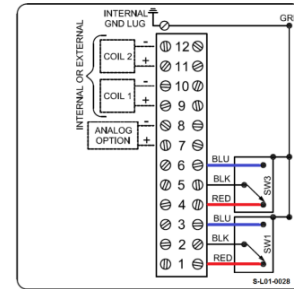

L2

Transmitters

Option	Type	Signal	Electrical Rating
_X	Potentiometer	4-20mA	8.5-34VDC

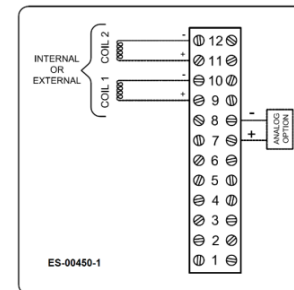

_X

HART

Option	Type	Signal	Electrical Rating
_H	Potentiometer	4-20mA, HART	15-39VDC

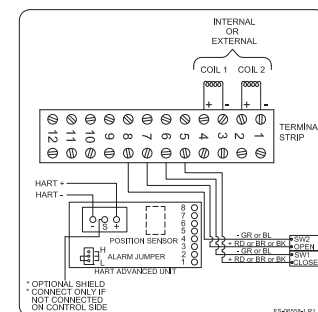

Please see Installation and Operation Manual for complete product dimensions or contact us for additional information at info.TopWorx@Emerson.com

Solenoid Valves

D-Series

<u>Voltage</u>	<u>Power Consumption</u>	<u>Pressure Rating</u>
24VDC	.5W	45-150 PSI
110VAC	3VA	45-150 PSI
220VAC	3VA	45-150 PSI
Piezo	12mW	45-150 PSI



T-Series

<u>Voltage</u>	<u>Power Consumption</u>	<u>Pressure Rating</u>
24VDC	.5W (I.S.), 1W (non-I.S.)	30-100 PSI
110VAC	3VA	30-100 PSI
220VAC	3VA	30-100 PSI

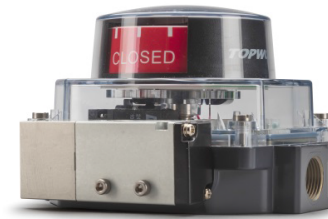

Ordering Guide

How to configure the right product for your application.

We recommend you call your local sales representative, inside sales, or use the online configurator tool at Emerson.com/TopWorx to ensure you choose the right product for your application.

The following is an example of how to configure your product using the TopWorx Ordering Guide. A switchbox part number can be configured by following a number of sequential steps. The ordering guide is organized in a number of categories which are setup as columns. By moving from right to left and filling in the boxes at the bottom of each column you will create a valid switchbox part number.

The following example is for reference and does not reflect all the available options of a TopWorx switchbox. Refer to the full ordering guide for full product options.

Product part number example:
DXP-L21GNEB1A21

TOPWORX™ D-SERIES, DXP, DXR, DXS ORDERING GUIDE

Choose one option from each category to build a complete model number.
Consult factory for options not shown below.

Enclosure	Bus/Sensor	Area Classification	Visual Display	Shaft	Conduit Entries
<p>DXP Tropicalized Aluminum</p> <p>DXR Composite Resin ("S" Silicone O-Rings only; Stainless steel conduit entries) (Area Classification "0" only available with ATEX/IECEx approvals)</p> <p>DXS 316 Stainless steel (Only available with "R" or "M" shaft options)</p>	<p>Bus Network AS AS-Interface (Area class cannot be 0)</p> <p>*FF Foundation Fieldbus w/ (2) SPDT GGO Switches</p> <p>*FL Foundation Fieldbus w/ (2) SPDT GGO Switches</p> <p>*FP Foundation Fieldbus w/ (2) SPDT GGO Switches and 0-10K Pot (Area class cannot be 0)</p> <p>DN DeviceNet (Area class cannot be 0)</p> <p>ES ES2/PT Module w/GO Switch (Area class cannot be 0)</p> <p>GO Switches L2 (2) GGO Switches - DPDT hermetic seal</p> <p>L4 (4) GGO Switches - SPDT hermetic seal (not available with pilot)</p> <p>Z2 (2) GGO Switches - DPDT hermetic seal</p> <p>Z4 (4) GGO Switches - DPDT hermetic seal (not available with pilot)</p> <p>Mechanical Switches (Area class cannot be 2, DXR with C approval not available with pilot)</p> <p>M2 (2) Mech. SPDT No Adder</p> <p>M4 (4) Mech. SPDT</p> <p>M6 (6) Mech. SPDT</p> <p>T2 (2) Mech. DPDT</p> <p>K2 (2) Mech. SPDT gold contacts</p> <p>K4 (4) Mech. SPDT gold contacts</p> <p>Proximity Switches R2 (2) SPDT Prox switches</p> <p>R4 (4) SPDT Prox switches (R2 & R4 only available with DXR and Ex me certification)</p> <p>Inductive Sensors E2 (2) p1f Nj2-V3-N</p> <p>Inductive NAMUR E4 (4) p1f Nj2-V3-N inductive NAMUR</p> <p>Analog Output (Available with 2-switch options only for L, Z, M, K, E, T)</p> <p>_X 4-20mA transmitter</p> <p>_H 4-20mA transmitter with HART (Not available with switch option T; LH not available w/pilot valve) (LH, ZH not available with DXR)</p> <p>Example: LH-(2) GGO Switches with HART™ transmitter</p> <p>* "FF", "FL" and "FP" with Area Classification "0" has an ib protection</p>	<p>0 Intrinsically safe (Bus/sensor cannot be AS, DN, ES, or _X; Requires appropriate I.S. barrier)</p> <p>-North America Class Div 1&2 Groups A, B, C, D</p> <p>Type 4, 4X</p> <p>-ATEX/IECEx Zone 0</p> <p>IECEx T6/T4 Ex ia IIC Ex tb IIC, IP66/67 (Foundation Fieldbus) Zone 1, Ex Ib IIC T4, IP67</p> <p>1 Explosion proof / Flame proof (DXP's only)</p> <p>-North America Class I Div 1 Groups C, D; Class Div. 2 Groups A, B, C, D. (Groups A & B must be hermetically sealed)</p> <p>Type 4, 4X, -ATEX/IECEx Zone 1</p> <p>IE2C, IE2GD, T6/T4/T3 Ex d IIB/H2 Ex tb IIC IP66/67 (O-Rings must be S for DUST certification)</p> <p>2 Non-incendive (Bus/sensor must be L, Z, P, E, AS, FF, _X, _H, _E or DN)</p> <p>-North America Class I Div 2 Groups A, B, C, D; Class II Div 2 Groups F, G</p> <p>-ATEX (DMP's only) IE3G Ex nA nC tb, IP66/67 (O-Rings must be S for DUST certification)</p> <p>C General Purpose Type 4, 4X (not available with DXR with mechanical switches)</p> <p>C Flameproof (DXS not available with valve; Conduit entries must be E or M) ATEX/IECEx IE2C, IE2GD, T6/T4/T3 Ex d IIC Ex tb IIC IP66/67</p> <p>M Flameproof (only available with R2 and R4 sensor options) (DXR only) ATEX/IECEx Zone 1, IE3G Ex e mb IIC T4, Ex tb IIC T66 IP67</p> <p>W No approvals; Type 4, 4X IP66/68</p> <p>For complete information on certification options, go to www.topworx.com and download the applicable product certificate.</p>	<p>G Standard 90° Green OPEN, Red CLOSED</p> <p>R Standard 90° Green CLOSED, Red OPEN</p> <p>B 90° Black OPEN, Yellow CLOSED No Adder</p> <p>Y 90° Yellow OPEN, Black CLOSED</p> <p>1 3 way, 90° L Port</p> <p>3 3 way, 90° T Port</p> <p>5 3 way, 90° T Port</p> <p>7 3 way, 180° T Port 3 position</p> <p>9 3 way, 180° T Port 3 position</p>	<p>S 1/2" DD 304 stainless steel</p> <p>N NAMUR 304 stainless steel</p> <p>R 1/2" DD 316 stainless steel (Shaft & external hardware)</p> <p>M NAMUR 316 stainless steel (Shaft & external hardware)</p>	<p>DXP/DXS (Metal Conduit Entries) E (2) 3/4" NPT</p> <p>4 (2) 3/4" NPT (2) 1/2" NPT</p> <p>M (2) M20</p> <p>3 (4) M20</p> <p>6 (4) 3/4" NPT</p> <p>DXR (Stainless Conduit Entries Required for North American approval) P (2) 1/2" NPT</p> <p>E (2) 3/4" NPT</p> <p>M (2) M20</p> <p>DXS (Resin Conduit Entries) A (2) 1/2" NPT</p> <p>B (2) 3/4" NPT</p> <p>C (2) M20</p>
<p>Enclosure DXP</p>	<p>Bus/Sensor L 2</p>	<p>Area Classification 1</p>	<p>Visual Display G</p>	<p>Shaft N</p>	<p>Conduit Entries E</p>

When configuring a valve monitor, the part number is considered complete once the “o-ring” option is specified and the rest of the options can be left blank, i.e., DXP-L21GNEB. If a on/off valve controller is configured the part number is considered complete once the “Valve Cv” option is specified, i.e, DXP-L21GNEB1A2. “Regional Certs” and “Manual Override” options can be left blank or specified. If a “Regional Certs” options is specified and “Manual Override” is left blank the part number will look as follows: DXP-L21GNEB1A20N.

Product part number example:
DXP-L21GNEB1A21

Ordering Examples: DXP-FFOGNEBPA2 DXP-L21GNEB1A2					
O-Rings	Pilot	Spool Valve	Valve Cv	Manual Override	Regional Certs
B Buna-N No Adder S Silicone No Adder NOTE: For Temperatures below -40°C, Silicone o-rings are recommended	Blank No pilot device(s) 1 (1) 24 Vdc pilot, fail open/closed 0.5W (non-I.S.) 0.5W (I.S.) 2 (2) 24 Vdc pilots, fail last position 0.5W (non-I.S.) 0.5W (I.S.) 4 (1) 220 Vac pilot, 2W, fail open/closed 5 (2) 220 Vac pilots, 2W, fail last position 7 (1) 110 Vac pilot, 1.1W, fail open/closed 8 (2) 110 Vac pilots, 1.1W, fail last position P (1) piezo pilot, fail open/closed (FF only) R (2) piezo pilots, fail last position (FF only)	Blank No Spool Valve A Aluminum Hard coat anodized 6 316 Stainless steel	Blank No Spool Valve 2 1/6 Cv (1/4" NPT Ports) 3 3.7 Cv (1/2" NPT Ports) (For manual override consult factory) (Spool Valve A) (Spool Valve E)	Blank No override 1 Single Pushbutton Momentary/Latching 2 Dual Pushbutton Momentary/Latching T Partial stroke test button with lockable cover (Sensor ES only) (Not avail w/ Area Class C) (DXP/S - Conduit Entries 4 or 3 only, DXR - consult factory)	Blank No Regional Cert B InMetro (Area Class 0, 1 and C only) N NEPSI F FISCO (Bus/Sensor must be FF, Area Class must be 0) K KOSHA (DXP/S only) (Area class 1 or C) R EAC (DXP/S only)(O-Rings must be B or S, B-Cas Approved, L-Cas (Dust Approved) A ANZEx Ex d IIC, Ex d IIB+H2 (DXP/S only) P PESO (India) (Gas approval only)
O-Rings B	Pilot 1	Spool A	Valve Cv 2	Override 1	Regional Certs N/A

Enabling communication with your automated on/off valves.







TOPWORX™

TopWorx discrete valve control and GO Switch position sensing technology provides absolute assurance in the most challenging applications by increasing reliability, profitability and reducing down time. Engineered to meet tough applications while offering high reliability and installation flexibility, these rugged, dependable, and affordable models are designed to provide dependability in all environments.

Visit us: Emerson.com/TopWorx

Your local contact: Emerson.com/contactus

-  Emerson.com/TopWorx
-  Facebook.com/EmersonAutomationSolutions
-  LinkedIn.com/company/Emerson-Automation-Solutions
-  Twitter.com/EMR_Automation

The Emerson logo is a trademark and service mark of Emerson Electric Co. Brand logotype are registered trademarks of one of the Emerson family of companies. All other marks are the property of their respective owners. © 2020 Emerson Electric Co. All rights reserved. BR000074ENUS-02_08-20 / Printed in the U.S.A.



CONSIDER IT SOLVED™